

MUSIC PRODUCTION STUDIO

SEQTRAK User Guide

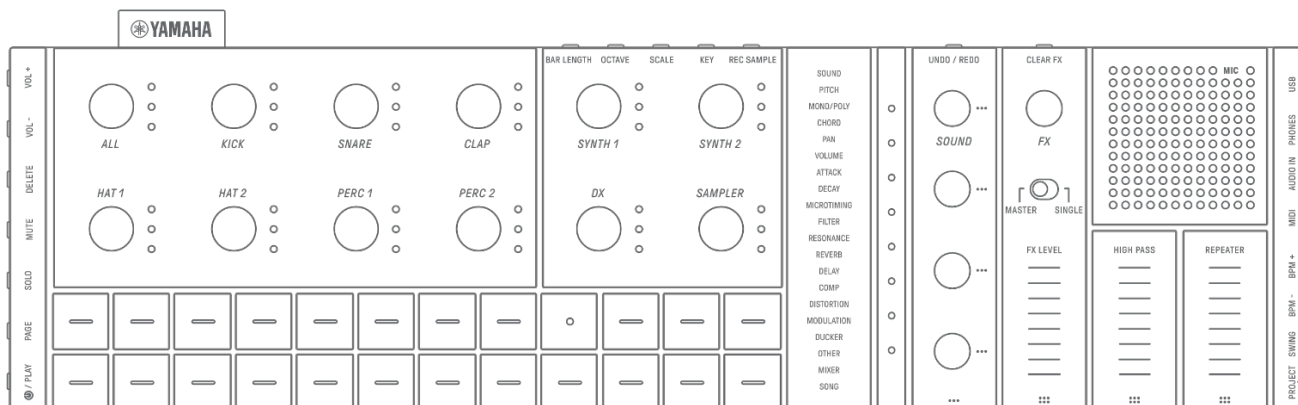

Information

- The SEQTRAK functions described in this User Guide are for OS V1.20. Please update your SEQTRAK to the latest firmware version. See "[17. Firmware Updates](#)" for instructions on how to update.
- All illustrations and screenshots (screenshots of the iOS app) included in this User Guide are for the purpose of explanation. The actual specifications might differ.

Trademarks

- Windows is a registered trademark of Microsoft® Corporation in the United States and other countries.
- Apple, iPhone, iPad, iPadOS, Lightning, Mac, and App Store are trademarks of Apple Inc., registered in the U.S. and other countries.
- IOS is a trademark or registered trademark of Cisco in the U.S. and other countries and is used under license.
- Android and Google Play are trademarks of Google LLC.
- Wi-Fi and Wi-Fi CERTIFIED are registered trademarks or trademarks of Wi-Fi Alliance®.
- The Wi-Fi CERTIFIED™ Logo is a certification mark of Wi-Fi Alliance®.



- The Bluetooth® word mark and logos are registered trademarks owned by Bluetooth SIG, Inc. and any user of such marks by Yamaha Corporation is under license.



- "USB Type-C" and "USB-C" are trademarks of USB Implementers Forum, registered in the U.S. and other countries.
- MIDI is a registered trademark of the Association of Musical Electronics Industry (AMEI).

- All other company names and product names mentioned in this guide are the trademarks or registered trademarks of their respective companies.

Table of Contents

1. What is SEQTRAK?	9
1.1 About the Manuals.....	9
1.1.1 Notation.....	9
1.2 SEQTRAK Configuration	11
1.2.1 Drum section.....	11
1.2.2 Synth section	12
1.2.3 Sound Design & FX section	12
1.3 Projects, Tracks, and Patterns.....	12
1.3.1 Projects	12
1.3.2 Tracks	12
1.3.3 Patterns	13
1.3.4 Conceptual diagram of projects, tracks, and patterns	13
1.4 About the SEQTRAK App	13
1.4.1 Obtaining the SEQTRAK app.....	13
1.4.2 Connecting to the SEQTRAK app	13
2. Panel Sections and Main Functions	14
①–⑥ Left side	14
⑦–⑯ Top Left (Drum section, Synth section)	15
⑰–⑳ Top Right (Sound Design & FX section)	16
㉘–㉛ Right side.....	17
3. Charging and Power Supply	19
3.1 Charging.....	19
USB power adapter / USB mobile battery requirements	20
3.1.1 Charge status (when the power is on).....	20
3.1.2 Charge status (when the power is off)	21
3.2 Power Supply	22
3.2.1 Turning the power on/off.....	22
3.2.2 Forced termination	22
3.2.3 Setting Auto Power Off	22

4. Projects	23
4.1 Switching Projects	23
4.1.1 Switching projects during external MIDI clock synchronization [OS V1.20].	23
4.2 Saving a Project.....	24
4.3 Backing Up and Restoring a Project	24
4.4 Deleting a Project	25
4.5 Setting the Tempo of a Project	25
4.5.1 Changing the playback tempo of a project	25
4.5.2 Applying a swing feeling to a project.....	26
4.5.3 Turning the metronome on/off.....	26
4.6 Temporarily Saving a Project.....	27
5. Tracks and Patterns	28
5.1 Switching Patterns	28
5.1.1 Using a Track knob to switch patterns	28
5.1.2 Using a Drum key to switch patterns.....	28
5.1.3 Changing Launch Quantize.....	29
5.2 Changing the Length of a Pattern	30
5.2.1 Drum tracks.....	30
5.2.2 Synth tracks (SYNTH 1, SYNTH 2, DX), SAMPLER track	31
5.3 Changing the Number of Patterns (3 Patterns ⇔ 6 Patterns).....	32
5.4 Deleting a Pattern.....	33
5.5 Copying and Pasting Patterns.....	33
5.6 Selecting and Auditioning Tracks	34
5.7 Changing the Sound of a Track	34
5.7.1 Selecting a sound category (category jump)	35
5.7.2 Drum track sound categories	35
5.7.3 Synth track (SYNTH 1, SYNTH 2, and DX) sound categories.....	35
5.7.4 SAMPLER track sound categories	35
5.8 Muting and Soloing a Track.....	36
5.8.1 Mute.....	36
5.8.2 Solo.....	36
5.9 Copying and Pasting Track Steps	37
6. Drum Tracks	38
6.1 Entering Steps	38
6.2 Switching Pages.....	38
6.3 Fine-tuning the Rhythmic Timing of a Step (Micro Timing).....	39
6.4 Setting the Consecutive Number of Times a Step is Triggered (Substep).....	39
6.5 Real-time Input	40
6.6 Changing the Probability of Triggering a Step.....	41

7. Synth Tracks (SYNTH 1, SYNTH 2, DX)	42
7.1 Real-time Input	42
7.2 Turning Quantize On/Off.....	43
7.3 Changing the Octave.....	43
7.4 Changing the Scale	44
7.5 Changing the Key	44
7.6 Playing Chords.....	45
7.7 Editing Chords	46
7.8 Switching to Keyboard Input Mode.....	47
7.9 Entering Steps	47
8. SAMPLER Track	49
8.1 Real-Time Input	49
8.2 Sampling (Built-In Microphone/AUDIO IN and USB Audio Input).....	49
8.3 Changing the Sampling Source.....	50
8.4 Resampling	50
8.5 Canceling Sampling	50
8.6 Setting the Count-In to Start Sampling.....	51
8.7 Switching to Monitoring Mode.....	51
8.8 Turning Auto-Normalize On/Off	52
8.9 Deleting Patterns for Each Sample.....	52
8.10 Entering Steps	52
8.11 Muting samples [OS V1.20].....	54
9. Sound Design	55
9.1 Adjusting Sound Parameters	55
9.1.1 Switching between the sound parameter operation pages	56
9.1.2 Drum track sound parameters	56
9.1.3 Synth track (SYNTH 1 and SYNTH 2) sound parameters	57
9.1.4 Synth track (DX) sound parameters.....	58
9.1.5 SAMPLER track sound parameters.....	59
9.2 Setting Sound and Effect Parameters for Each Step (Parameter Lock).....	60
9.2.1 Deleting a Parameter Lock	61
9.3 Recording the Movement of Sound and Effect Parameters in Steps (Motion Recording).....	63
9.3.1 Deleting a Motion	63
9.4 Undoing/Redoing Sound and Effect Parameters	64
9.5 Saving a Sound	64
9.6 Deleting a Sound	64
9.7 Importing a Sound.....	65

10. Effects	66
10.1 Configuration of Effects	66
10.1.1 Track effects	66
10.1.2 Send effects	67
10.1.3 Master effects	68
10.2 Changing and Adjusting Effects	69
10.2.1 Switching the effect to be controlled	69
10.2.2 Changing the type of effect	69
10.2.3 Adjusting effect parameters	69
10.2.4 Effect parameters when MASTER is selected	70
10.2.5 Effect parameters when SINGLE is selected	70
10.2.6 Example: Parameters when MASTER is selected and preset No. 1 [LPF - NO RESONANCE] of FILTER is selected	70
10.3 Minimizing the Level of Effect Parameters (CLEAR FX)	70
11. Mixer Mode	71
11.1 Switching to Mixer Mode	71
11.2 Adjusting Sound Parameters	71
11.3 Changing and Adjusting Send Effects (REVERB, DELAY)	72
11.3.1 Changing the type of send effect (REVERB, DELAY SEND)	72
11.3.2 Adjusting send effect (REVERB, DELAY) parameters	72
11.3.3 Send effect (REVERB, DELAY) parameters	73
11.3.4 Example: Send effect parameters for preset No. 1 [HD Room] in REVERB	73
12. Mute Mode [OS V1.20]	74
12.1 Switching to Mute Mode	74
12.2 Muting tracks in Mute Mode	74
13. Song Mode	75
13.1 Switching to Song Mode	75
13.1.1 Switching to Scene mode	75
13.2 Playing/Stopping a Scene	76
13.2.1 Changing the scene to be played back	76
13.2.2 Repeating a scene (Loop Playback)	77
13.2.3 Repeating an entire song (Loop Playback)	77
13.3 Adding Scenes	78
13.4 Deleting a Scene	78
13.5 Editing a Scene	79
13.5.1 Changing the combination of patterns in a scene	79
13.5.2 Changing the length of a scene	79

14. SEQTRAK App	81
14.1 GUI Functions [GUI EDITOR]	81
14.2 Content Management Function [PROJECT/SOUND MANAGER]	82
14.3 Visualizer Function [VISUALIZER].....	83
14.4 Dynamic Tutorial Function [DYNAMIC TUTORIAL]	84
15. Connections	85
15.1 Connecting to the SEQTRAK App	85
15.1.1 Wired connection	85
15.1.2 Wireless connection (Bluetooth).....	86
15.1.3 Wireless connection (Wi-Fi).....	86
15.2 Connecting to MIDI Devices	87
15.2.1 Using a USB-C to USB-C cable.....	87
15.2.2 Using a MIDI conversion cable.....	88
15.3 Connecting to a Computer	88
15.3.1 Connecting to a computer (Windows).....	88
15.3.2 Connecting to a computer (Mac).....	88
16. Settings	89
16.1 Restoring the Factory Defaults (Factory Reset)	89
16.2 Changing the Sensitivity Settings of the Track Knobs	89
16.3 Configuring MIDI Settings	89
16.3.1 Setting the MIDI clock.....	89
16.3.2 Setting MIDI output filters	89
16.3.3 Setting MIDI Thru [OS V1.20].....	89
17. Firmware Updates	90
17.1 Using a USB Flash Drive	90
17.1.1 Formatting a USB flash drive.....	91
17.1.2 Updating the firmware	91
17.2 Using the SEQTRAK App (for a Wired Connection)	92
17.3 Using the SEQTRAK App (for a Wireless Connection)	92

18. Documentation	93
18.1 Product Specifications	93
18.2 MIDI Channels	94
18.3 MIDI Control Change Parameters	95
18.3.1 Sound Design parameters	95
18.3.2 Effect parameters	96
18.3.3 Mute/Solo	96
18.3.4 Other	97
18.4 MASTER EFFECT Presets	97
18.4.1 FILTER	97
18.4.2 REVERB	97
18.4.3 DELAY	98
18.4.4 COMPRESSOR	98
18.4.5 DISTORTION	98
18.4.6 MODULATION	99
18.4.7 DUCKER	99
18.4.8 OTHER	99
18.5 SINGLE EFFECT Presets	100
18.5.1 FILTER	100
18.5.2 REVERB	100
18.5.3 DELAY	100
18.5.4 COMPRESSOR	101
18.5.5 DISTORTION	101
18.5.6 MODULATION	101
18.5.7 DUCKER	101
18.5.8 OTHER	102
18.6 SEND EFFECT Presets	102
18.6.1 REVERB	102
18.6.2 DELAY	102
18.7 Description of Sound Parameters	103
18.8 Open-source Software	104

1. What is SEQTRAK?

SEQTRAK is an intuitive music production and performance tool with a sophisticated yet easy-to-understand workflow. Its compact size allows it to be used easily anywhere. In addition, the dedicated app gives you access to more detailed settings and allows you to create images linked to your songs.

To get the most out of SEQTRAK, please read this User Guide for more information about advanced features and operations.

1.1 About the Manuals

The following manuals are available for this product. Please read each guide that comes with the product and keep them handy for easy reference.

Supplied with the product

Quick Operation Guide (paper manual)	This guide helps you use the product immediately 'right out of the box,' with short explanations that focus on a general overview and basic functions.
Safety Guide (paper manual)	This guide describes information for safe use of the product.

Available on the website

User Guide (HTML, PDF)	This guide explains functions and operations of the product in more detail.
Data List (PDF)	This list contains various important lists such as a Sound List and Effect Type List.

1.1.1 Notation

The following terms and symbols are used throughout this User Guide. Be sure to understand these terms and symbols before reading this guide.

⚠ CAUTION Indicates a hazardous situation that could result in injury.

NOTICE Indicates a hazardous situation that could result in malfunction, or damage to the product, or loss of data.

NOTE Provides additional explanations regarding functionality, example applications, and tips.

The various states of the LEDs (off, on, and flashing) are indicated as shown below.

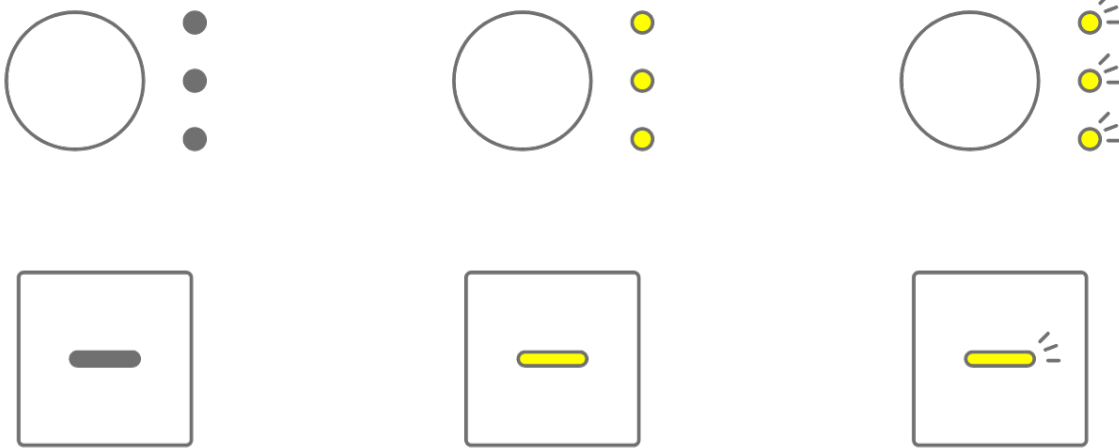

The various operations of SEQTRAK are indicated as shown below.

- Pressing a button, knob, or key



- Pressing and holding a button, knob, or key

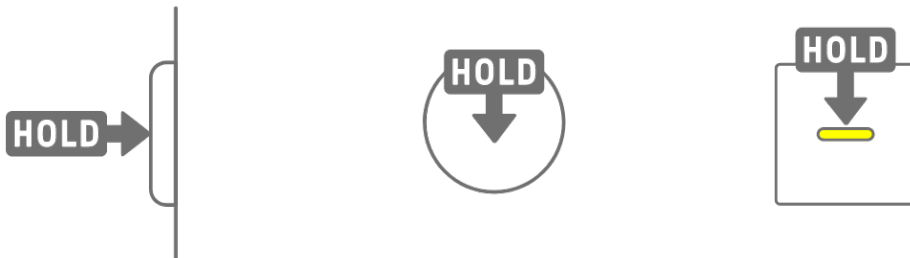

- Pressing and holding a button, knob, or key for N seconds or longer

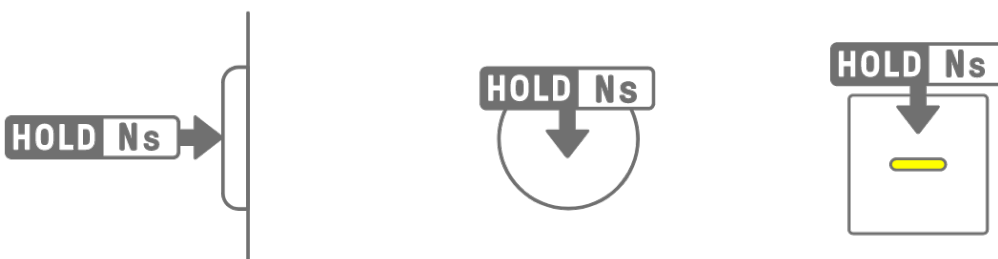

- Turning a knob



1.2 SEQTRAK Configuration

SEQTRAK is made up of three sections.

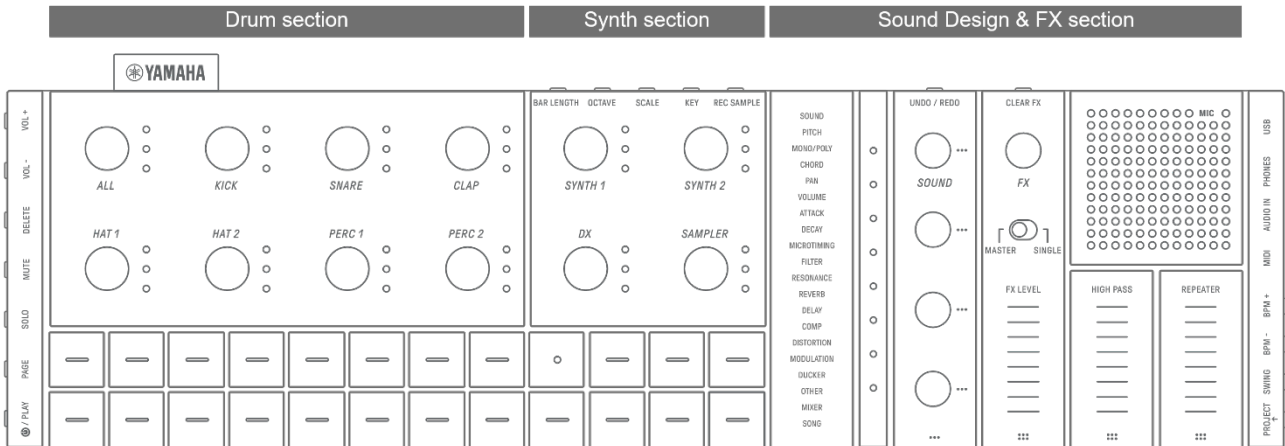

1.2.1 Drum section

This section is used to produce rhythm parts. The Track knobs and Drum keys are used to control the seven Drum tracks (KICK, SNARE, CLAP, HAT 1, HAT 2, PERC 1, PERC 2). The most basic method of producing a rhythm part is to use the Drum keys to enter steps. Press a Track knob to select that track, and then press a Drum key to place a sound on the time axis. This makes it easy to produce beats.

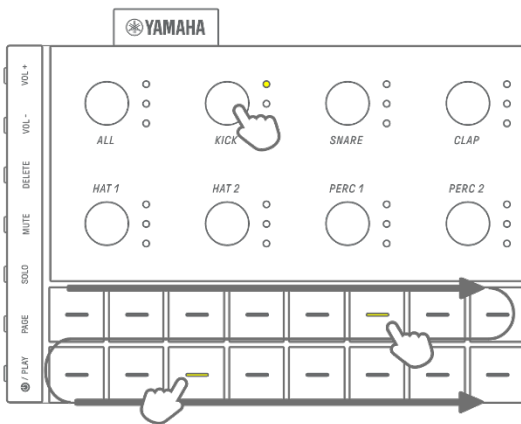

1.2.2 Synth section

This section is used to produce melody parts. The Track knobs and Synth keys are used to control the three Synth tracks (SYNTH 1, SYNTH 2, and DX) and the SAMPLER track. The most basic method of performance and production is to use the Synth keys for real-time input. Press a Track knob to select that track, and then press a Synth key to play a note on the scale.

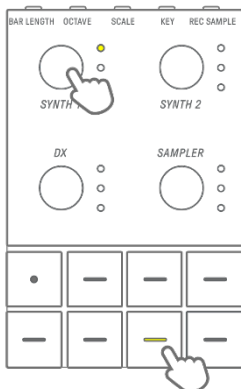

1.2.3 Sound Design & FX section

This section is used to change the sound of individual tracks, adjust parameters, and manipulate effects. The Sound Design knobs are used to select sounds and adjust detailed parameters. One track effect can be applied to each track and a shared master effect can be applied to all tracks.

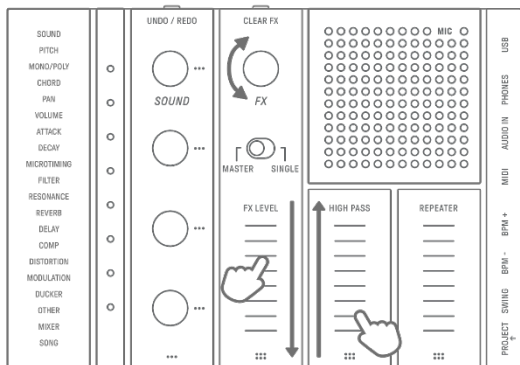

1.3 Projects, Tracks, and Patterns

1.3.1 Projects

SEQTRAK manages the data of a single song in units called “projects.” Up to eight projects can be stored in SEQTRAK, and one project can be used at a single time. A project consists of 11 tracks, and up to 6 patterns can be created on each track. A project also includes settings and states such as tempo and track volume.

1.3.2 Tracks

A track is a component of a project, and is a performance part to which a single sound is assigned.

1.3.3 Patterns

Patterns are phrases that are played in a loop. You can choose one pattern for each track, from up to six available patterns. You can play the same phrase repeatedly or switch between them at any time you like. The patterns on the 11 tracks will continue to play on top of each other until playback is stopped.

1.3.4 Conceptual diagram of projects, tracks, and patterns

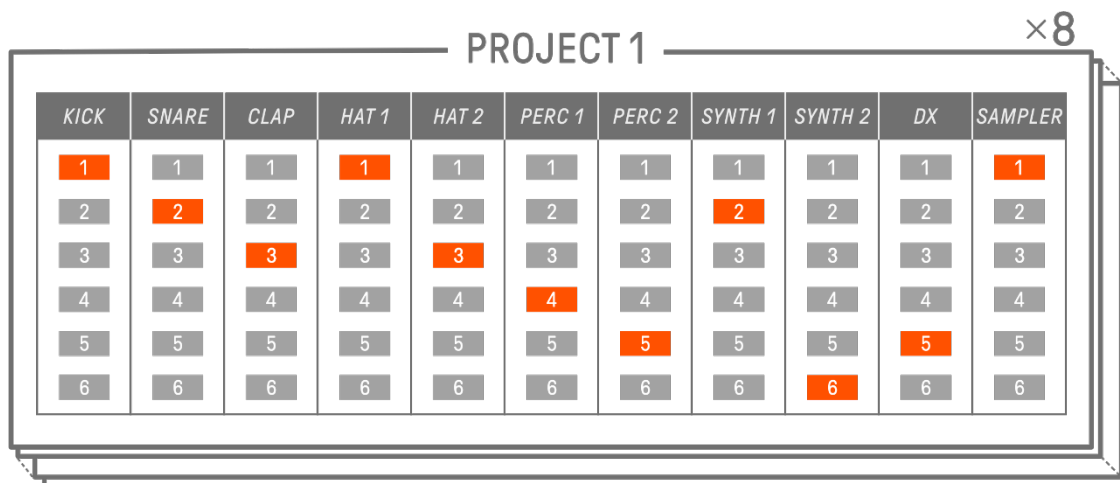

Track Selected pattern Pattern not selected

1.4 About the SEQTRAK App

Using the dedicated SEQTRAK app, you can edit sounds in more detail, produce images linked to performances SEQTRAK, and manage your content. See “[14. SEQTRAK App](#)” for an overview of the functions in the SEQTRAK app.

The software can be used on smartphones (iOS and Android), tablets (iPadOS and Android), and computers (Windows and Mac).

1.4.1 Obtaining the SEQTRAK app

The iOS, iPadOS, and Android versions are available from the App Store and Google Play Store.



Search for “SEQTRAK.”

Windows and Mac versions are available from the following Yamaha website.

<https://www.yamaha.com/2/seqtrak/>

1.4.2 Connecting to the SEQTRAK app

When the SEQTRAK app is launched, instructions for how to connect SEQTRAK to the SEQTRAK app are displayed, if necessary. Follow the onscreen instructions to set up the connection. See “[15.1 Connecting to the SEQTRAK App](#)” for detailed connection instructions.

2. Panel Sections and Main Functions

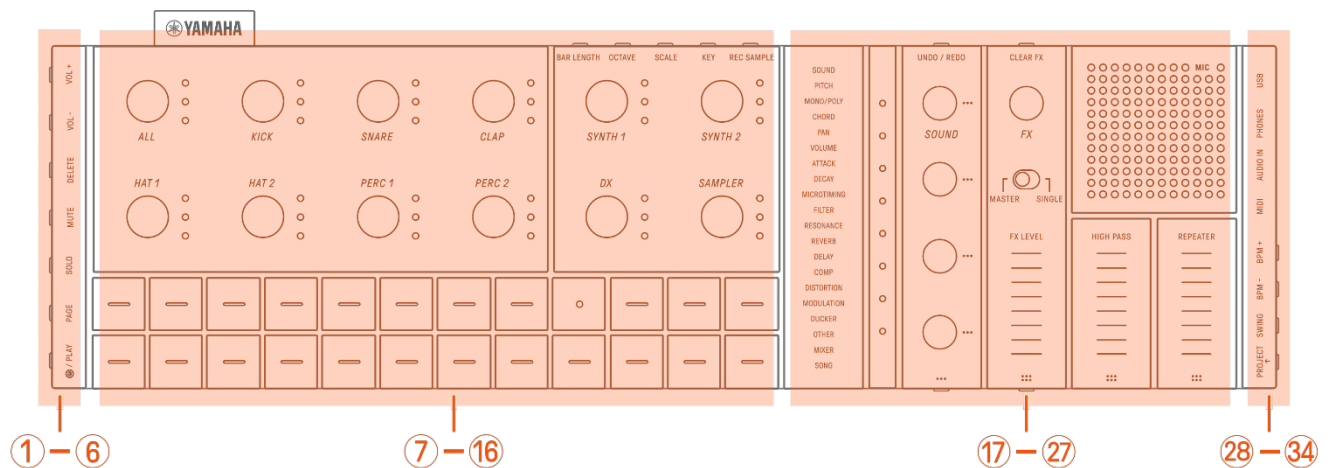

①-⑥ Left side

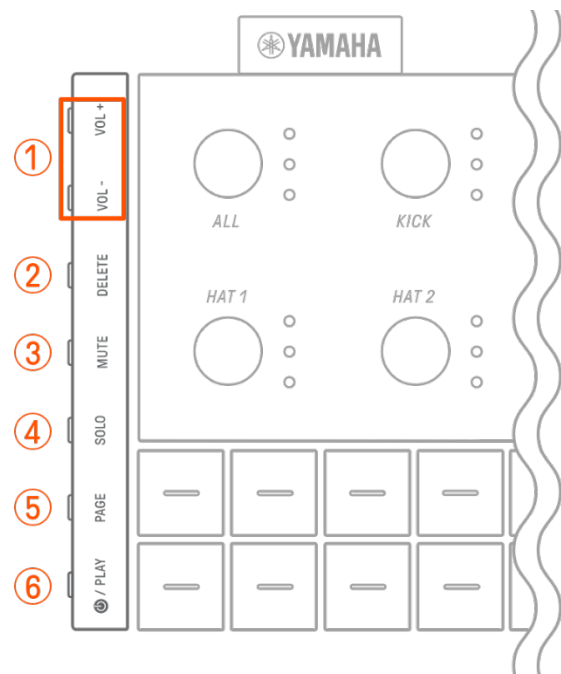

① [VOL+]/[VOL-] buttons

Used to adjust the volume of sound coming from the built-in speaker or headphones connected to the [PHONES] jack.

② [DELETE] button

Used to delete a pattern or project.

③ [MUTE] button

Used to mute a specific track.

④ [SOLO] button

Used to solo a specific track.

5 [PAGE] button

Used to switch the range of patterns (pages) displayed on the Drum keys and to change the length of the patterns on the Drum tracks.

6 [⏻/PLAY] button

Used to turn the power on/off and to play/stop a project.

7–16 Top Left (Drum section, Synth section)

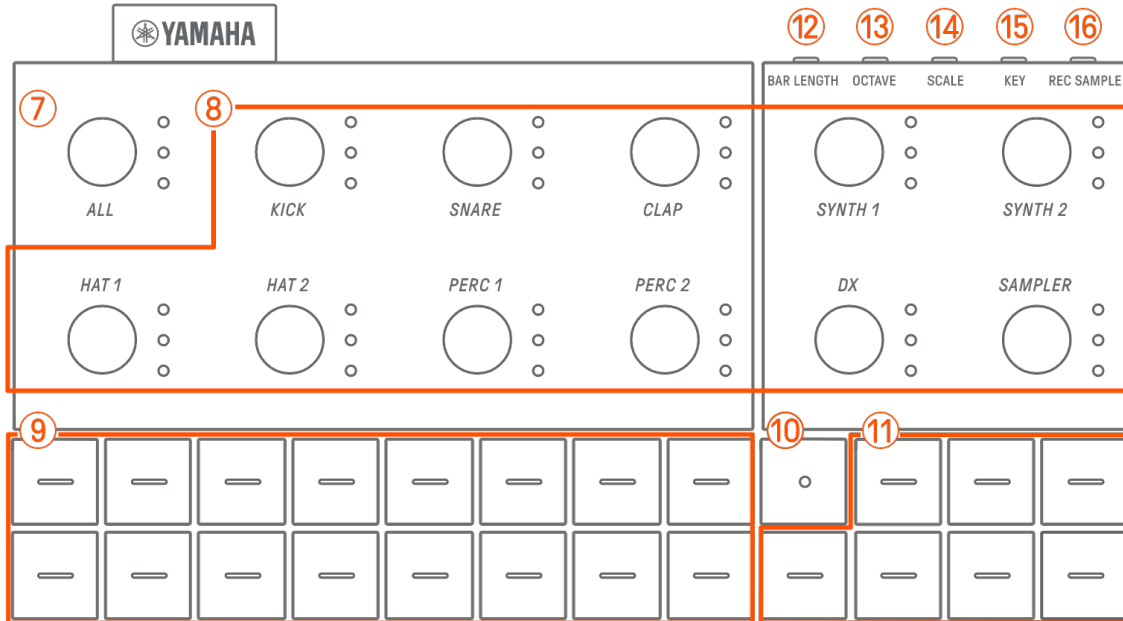

7 [ALL] knob

Turn this knob to change the patterns for all 11 tracks simultaneously.

8 Track knobs

Turn these knobs to change the pattern for each individual track. Press to select a track. Press a knob while playback is stopped to audition the sound for that track.

9 Drum keys

Press these keys to turn each step on/off. Hold down a Drum key and turn a Sound Design knob to lock a parameter.

10 Record key

Used to execute real-time recording. You can record a performance with the Synth keys or record MIDI input from an external source. You can also execute Motion Recording of parameters.

11 Synth keys

Press to play the selected Synth track (SYNTH 1, SYNTH 2, or DX) or SAMPLER track.

12 [BAR LENGTH] button

Used to change the length of the pattern in the currently selected Synth track (SYNTH 1, SYNTH 2, DX) and SAMPLER track.

13 [OCTAVE] button

Used to change the pitch of the currently selected Synth key by one octave.

14 [SCALE] button

Used to change the scale that is used when the Synth keys are pressed.

15 [KEY] button

Used to change the key that is used when the Synth keys are pressed, in half steps.

16 [REC SAMPLE] button

Used for sampling on the SAMPLER track.

17–27 Top Right (Sound Design & FX section)

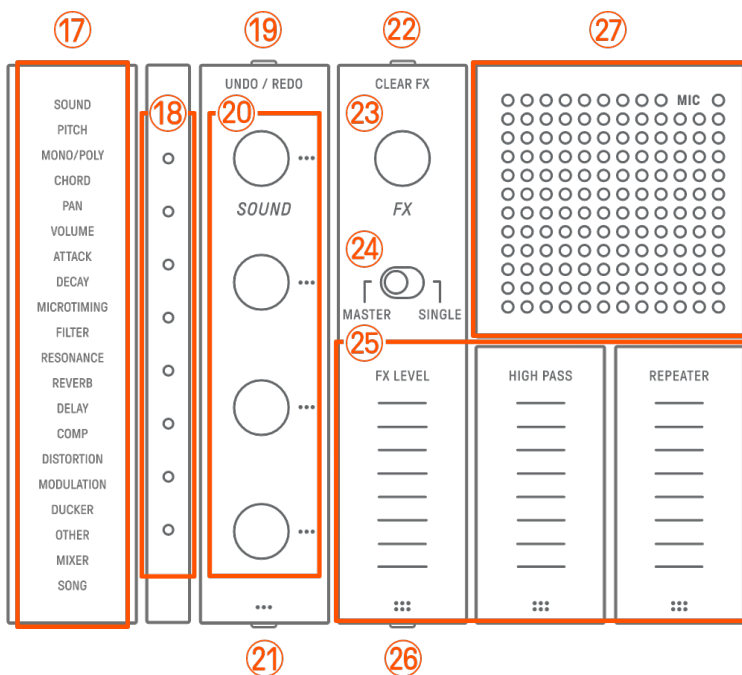

17 Index

Displays the selected parameter or mode.

18 Global Meter

Displays the value of the parameter being operated or the operating status while saving/loading data.

19 [UNDO/REDO] button

Used to UNDO/REDO sound and effect parameter changes.

20 Sound Design knobs 1–4

Turn these knobs to change the sound of a track or adjust parameters.

21 Sound Design Page button

Press to switch between the sound parameters controlled by the Sound Design knobs.

②② [CLEAR FX] button

Press to reduce an effect to the minimum level.

②③ [FX] knob

Turn this knob to change the type of effect.

②④ [MASTER/SINGLE] switch

Switches between the effects to be controlled.

MASTER: Effects applied to all tracks

SINGLE: Effects applied only to the target track

②⑤ [FX LEVEL] [HIGH PASS] [REPEATER] touch sliders

Slide to adjust the effect parameters.

When the effect page is set to Page 1, [HIGH PASS] and [REPEATER] are applied to all tracks regardless of how the [MASTER/SINGLE] switch is set.

②⑥ FX Page button

Press to change the parameters controlled by the touch sliders.

②⑦ Speaker and microphone

Built-in speaker and microphone.

②⑧–③④ Right side

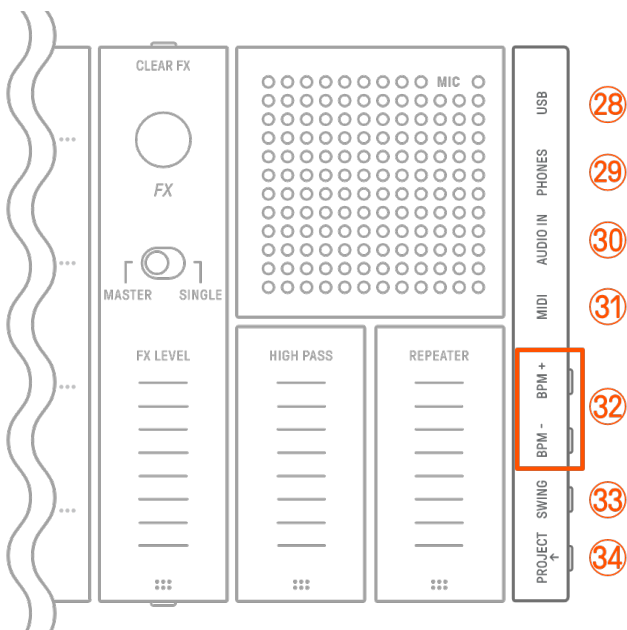

②⑧ [USB] terminal (USB Type-C™)

USB Type-C terminal. The included USB-C to USB-C cable can be used to charge the unit and to connect to computers and MIDI devices.

NOTICE

- After disconnecting the USB cable, wait at least 6 seconds before connecting it again. Quickly disconnecting and connecting the cable could cause the unit to malfunction.

②⑨ **[PHONES] jack**

Used for connecting headphones (stereo mini jack). When headphones are connected, no sound is output from the built-in speaker.

③⑩ **[AUDIO IN] jack**

Used for audio input (stereo mini jack), by connecting to the audio output terminal of an audio device.

③① **[MIDI] terminal**

Used for connecting an external MIDI device via the included MIDI conversion cable.

③② **[BPM+]/[BPM-] buttons**

Used to adjust the project playback tempo between 5 and 300 BPM. Press both buttons at the same time to set the tempo to the starting value for the recently opened project. The number of lights on the Global Meter gives a rough indication of the current tempo.

③③ **[SWING] button**

Press this button to apply a swing feeling to the entire project.

③④ **[PROJECT ↑] button**

Used to switch between projects.

3. Charging and Power Supply

3.1 Charging

SEQTRAK can be charged with a USB power adapter / USB mobile battery by using the included USB-C to USB-C cable. (When using a USB mobile battery for smartphones, make sure that it meets the requirements in [USB power adapter / USB mobile battery requirements](#).) Connect the power supply and the included USB-C to USB-C cable in the order shown below.

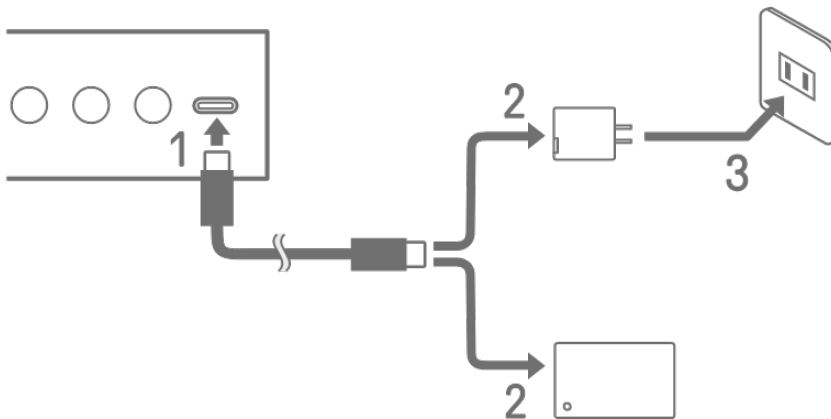

1. Connect the included USB-C to USB-C cable SEQTRAK.
2. Connect the included USB-C to USB-C cable to a USB power adapter or a USB mobile battery.
3. Connect the USB power adapter to a power outlet.

The charging status indication differs depending on whether SEQTRAK is turned on or off. See [“3.1.1 Charge status \(when the power is on\)”](#) and [“3.1.2 Charge status \(when the power is off\)”](#) for details.

NOTE

- The estimated time from low battery to full charge is 3–5 hours (depending on usage environment and battery deterioration).
- When the battery is low, the Global Meter will flash in red for 2 seconds every 90 seconds.

USB power adapter / USB mobile battery requirements

Output voltage 4.8 V to 5.2 V

Output current 1.5 A or greater

⚠ CAUTION

Make sure to use a USB Power Delivery (PD) power adapter or USB Power Delivery (PD) mobile battery with the specifications above. Using the wrong USB device can result in damage to the product or overheating. Read the safety precautions for your particular USB devices.

NOTICE

When the product is turned on and the power turns off suddenly and unexpectedly, your USB device might not meet the requirements or might be damaged. Try using another USB device that meets the requirements, etc. If the product appears to be malfunctioning, consult Yamaha service personnel.

3.1.1 Charge status (when the power is on)

Hold down both the [ALL] knob and the [⏻/PLAY] button. The Global Meter will then light according to the remaining battery power (charging: cyan blue, not charging: white, trouble: flashes red).

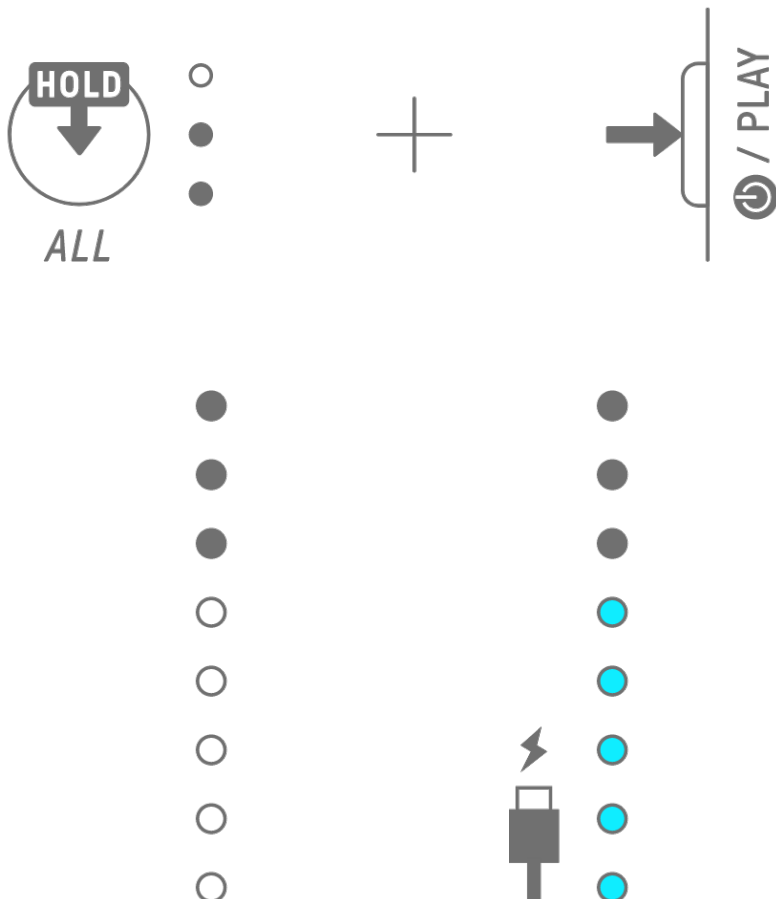

NOTE

- SEQTRAK can be used while charging.
- If the electricity supplied from the power supply is insufficient, it will be used for operation of the SEQTRAK and charging will not be possible even if the Global Meter are lit in cyan blue.

3.1.2 Charge status (when the power is off)

While charging, the top LED lamp of the Global Meter lights up in red. When charging is complete, the LED lamp will turn off. The battery level is not indicated when the power is off.

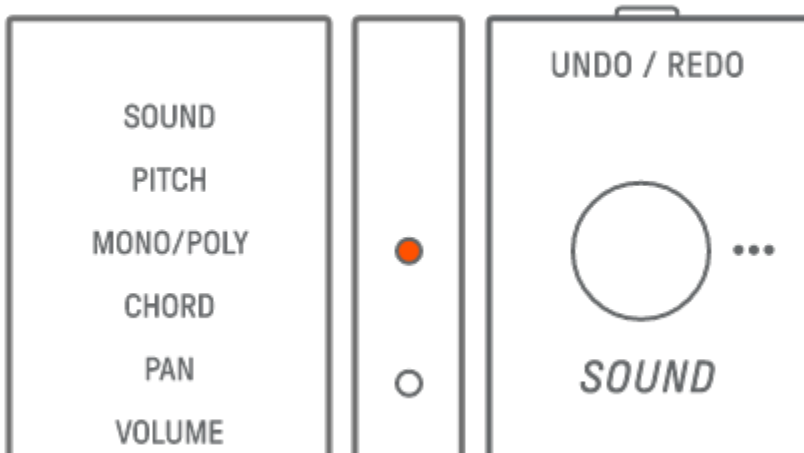

If SEQTRAK cannot be charged due to battery failure or other reasons, the top LED lamp of the Global Meter flashes in red.

3.2 Power Supply

3.2.1 Turning the power on/off

To turn the power on or off, press and hold the [⏻/PLAY] button for 2 seconds or longer.

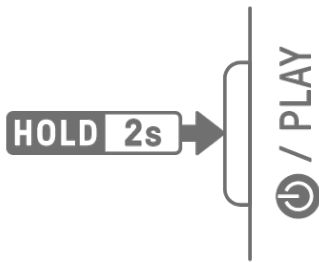

3.2.2 Forced termination

If SEQTRAK behaves abnormally and cannot be operated, you can turn the power off by pressing and holding the [⏻/PLAY] and [PROJECT ↑] buttons.

However, any changes that were made after SEQTRAK was started and before forced termination will not be saved.

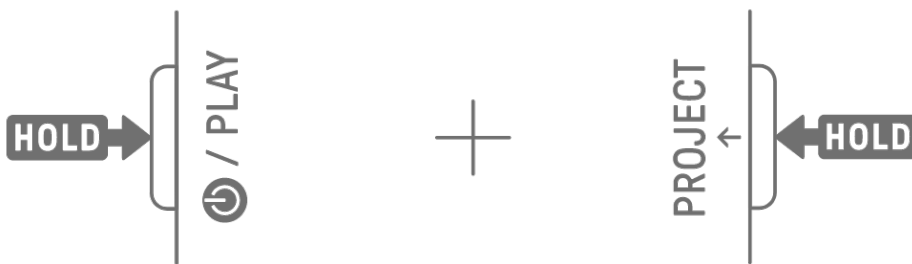

3.2.3 Setting Auto Power Off

If SEQTRAK is not operated for 30 minutes (when not being charged), the power will be turned off to save power. At this time, the current project will be saved automatically. You can disable and enable (30 minutes) the Auto Power Off function by turning on SEQTRAK while pressing the lower left Drum key.

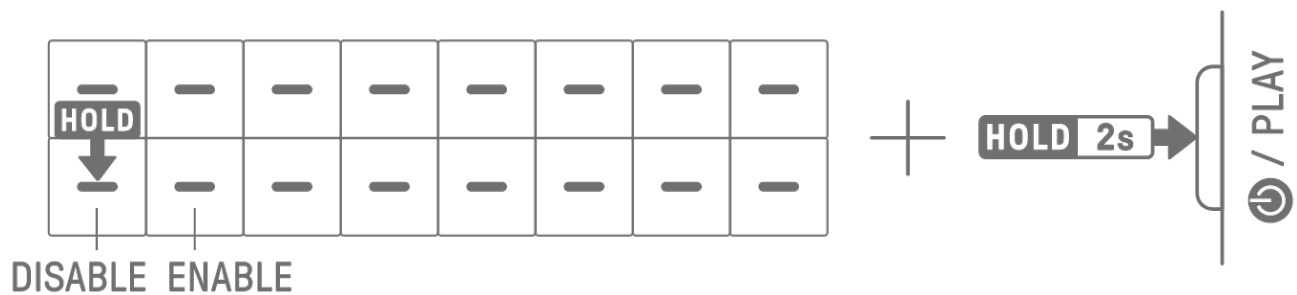

NOTE

- You can use the SEQTRAK app to change the time for the Auto Power Off function.

4. Projects

SEQTRAK manages the data of a single song in units called “projects.” Up to eight projects can be stored in SEQTRAK, and one project can be used at a single time. A project consists of 11 tracks, and up to 6 patterns can be created on each track. A project also includes settings and states such as tempo and track volume.

4.1 Switching Projects

To switch to another project, hold down the [PROJECT ↑] button and press a Drum key. Drum keys 1–8 correspond to projects 1–8. The Drum key for the currently selected project lights up in yellow.

In the factory default state, projects 1–3 contain demo data, and projects 4–8 contain only one KICK step. Demo data can be edited by the user.

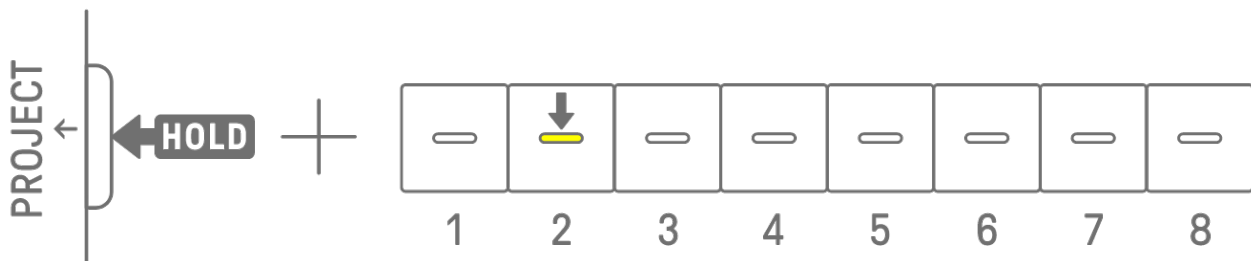

NOTE

- The current project will be saved automatically before switching projects.
- Switching to another project during playback stops playback.

4.1.1 Switching projects during external MIDI clock synchronization [OS V1.20]

When a switching operation is performed during project playback while synchronized to an external MIDI clock, the currently playing project stops at the end of a measure (16 steps). After stopping, the project to be switched to is loaded and enters playback standby.

Start project playback

Two modes (below) are available for determining when project playback of the next project is started.

MANUAL PLAYBACK Mode (default)

Pressing the [⏪/PLAY] button at any timing while in playback standby starts the destination project at the beginning of each 2-measure (32-step) interval.

AUTO PLAYBACK Mode

When in play standby, the next project will automatically start at the beginning of a measure (16 steps) based on the [Launch Quantize](#) setting.

If Launch Quantize is not in units of measures (1 measure = 16 steps), the project will be automatically aligned to the measure containing that number of steps, and the project will be started. However, if Launch Quantize is less than 2 measures, it will be automatically adjusted to 2 measures.

If the [⏻/PLAY] button is pressed before project play begins, automatic play is canceled and the project enters MANUAL PLAYBACK Mode.

These modes can be switched from the SEQTRAK app.

Disabling operation during external MIDI clock synchronization

Press the [PAGE] button while holding down the [PROJECT ↑] button to turn on/off the operation (measure-by-measure stop and playback start) during external MIDI clock synchronization. The default setting is on.

When the setting is on, the Global Meter lights up in white.

When the setting is off, the Global Meter turns off and the operation is the same as normal project switching.

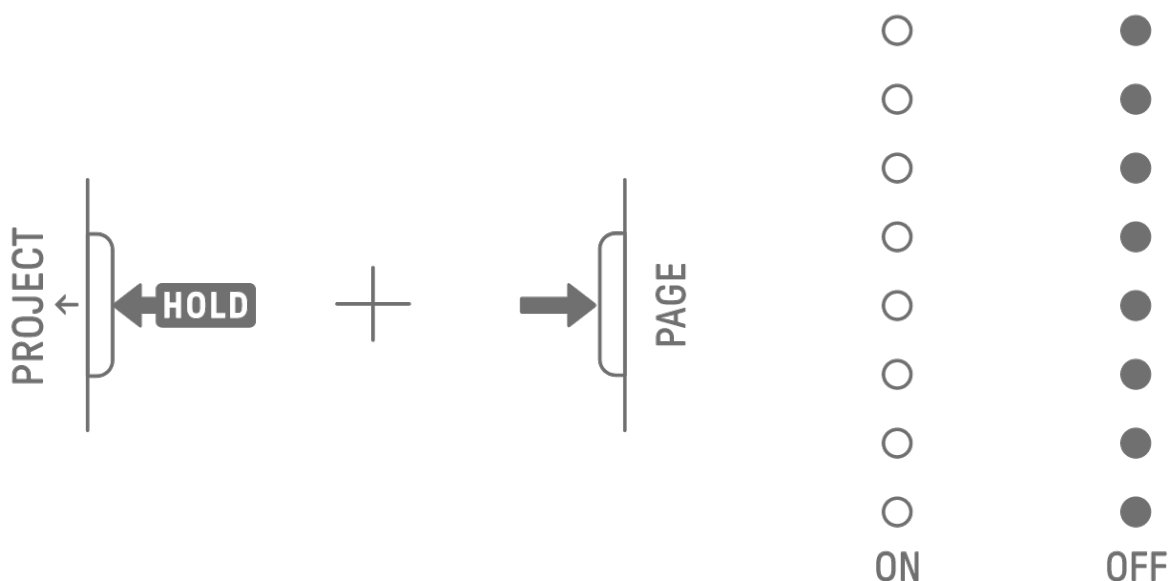

4.2 Saving a Project

Projects are saved automatically when SEQTRAK is turned off or when switching projects. No operation is required to save the project.

4.3 Backing Up and Restoring a Project

You can save a project in the SEQTRAK app and recall a project from the app to SEQTRAK.

4.4 Deleting a Project

To delete a project, hold down the [PROJECT ↑] and [DELETE] buttons and press the corresponding Drum key.

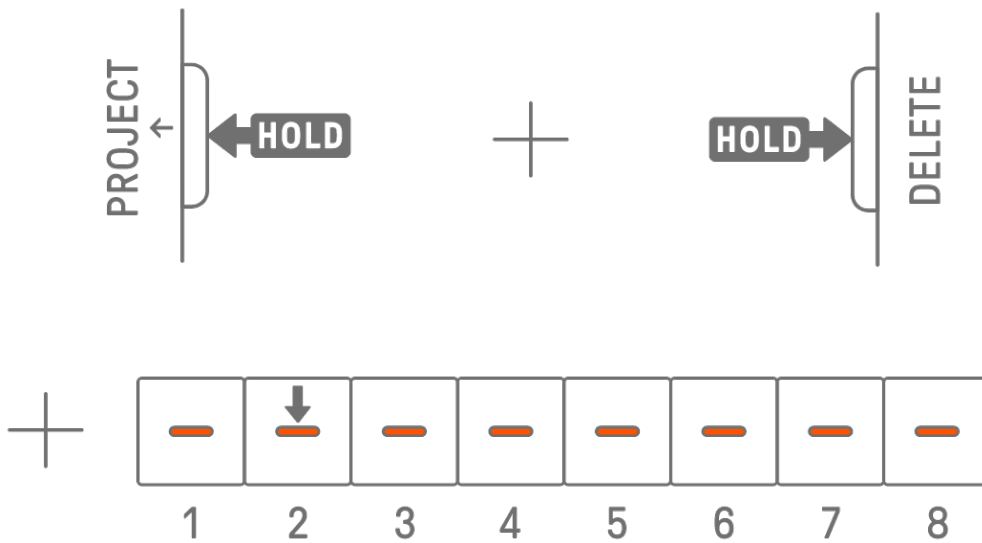

NOTE

- After a project is deleted, it will contain only one KICK step.
- The demo data for a deleted project can be restored as described in [“16.1 Restoring the Factory Defaults \(Factory Reset\).”](#)

4.5 Setting the Tempo of a Project

4.5.1 Changing the playback tempo of a project

To change the playback tempo of a project, press the [BPM+] or [BPM-] button. The tempo can be adjusted between 5 and 300 BPM. Press and hold the [BPM+] or [BPM-] button to scroll through the values continuously.

Press both buttons at the same time to set the tempo to the starting value for the recently opened project.

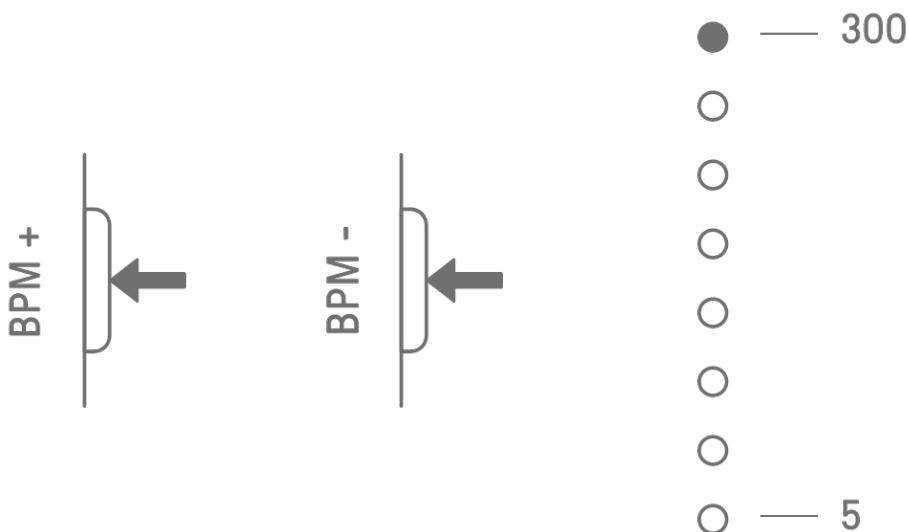

4.5.2 Applying a swing feeling to a project

To apply a swing to a project, press the [SWING] button. The swing rate of even steps can be set in the range from -58 ticks to +58 ticks.

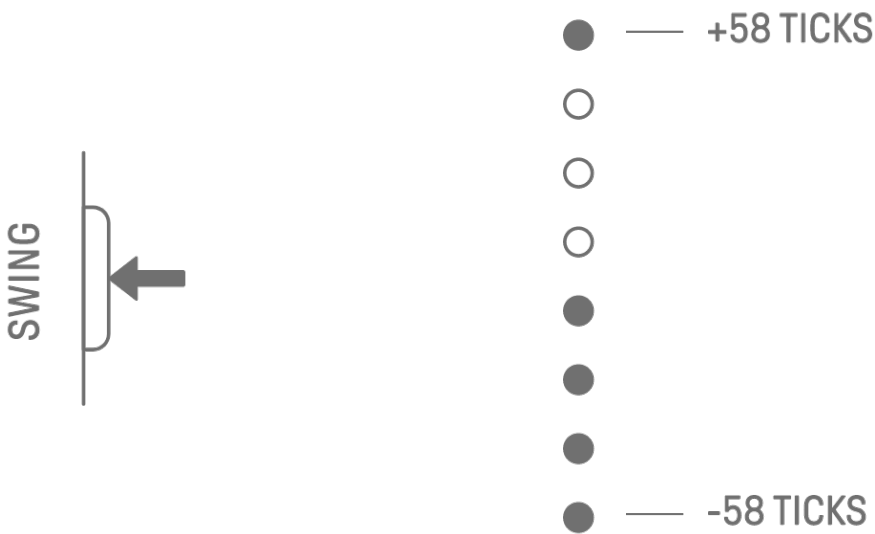

NOTE

- One step is 120 ticks.
- Hold down the [DELETE] button and press the [SWING] button to initialize the swing rate (reset to 0 ticks).
- Even steps are determined according to the criteria for [Launch Quantize](#).

4.5.3 Turning the metronome on/off

To turn the metronome on/off, hold down the [ALL] knob and press the [BPM+] button. The Global Meter lights up white when the metronome is on and turns off when the metronome is off.

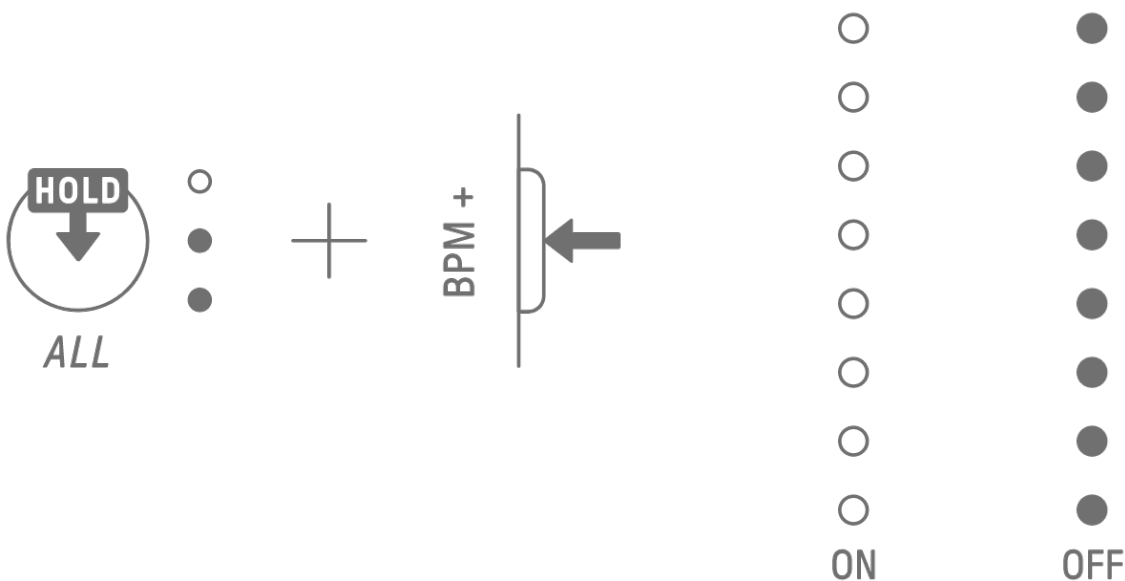

NOTE

- You can use the SEQTRAK app to change the sound and volume of the metronome. There are 5 metronome sounds to choose from. The volume can be adjusted between 0 and 127.
- The metronome clicks in 4-step intervals, with an accented note occurring at the beginning of [Launch Quantize](#).
Example 1: If Launch Quantize is a 16-step cycle, the metronome clicks on steps 1 (accented), 5, 9, 13, 17 (accented), 21, etc.
Example 2: If Launch Quantize is a 17-step cycle, the metronome clicks on steps 1 (accented), 5, 9, 13, 17, 18 (accented), 22, etc.

4.6 Temporarily Saving a Project

You can temporarily save a project at any time and restore its state later. To temporarily save a project, hold down the [PROJECT ↑] button and press the Drum key (lit in yellow) for the currently selected project.

Also, immediately after loading a project, the project is automatically temporarily saved. This allows you to restore the project immediately after loading. [OS V1.20]

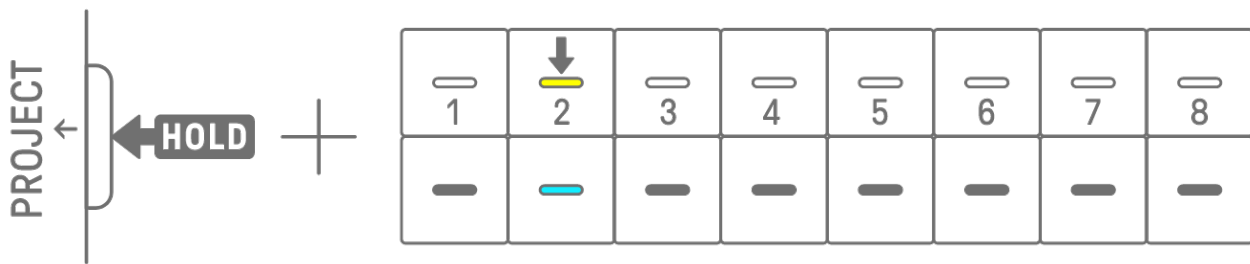

To restore a temporarily saved project, hold down the [PROJECT ↑] button and press the Drum key that is lit in cyan blue.

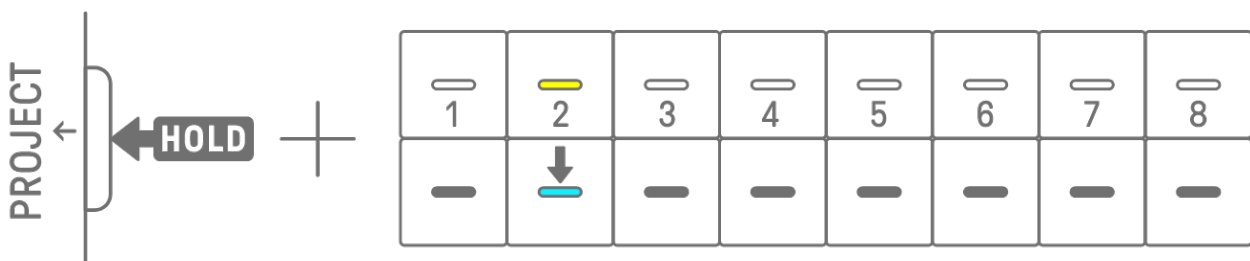

NOTE

- Only one project can be temporarily saved.
- Temporarily saved projects are deleted when you switch projects or turn off the power.
- If a sampled sound is not saved and another sample is saved to the same Synth key, the sound that was overwritten will also be deleted from the temporarily saved project. Be sure to save sampled sounds as necessary.

5. Tracks and Patterns

A track is a component of a project, and is a performance part to which a single sound is assigned. There are three types of tracks: Drum tracks, Synth tracks (SYNTH 1, SYNTH 2, and DX), and SAMPLER track. For details on each type of track, see “[6. Drum Tracks](#),” “[7. Synth Tracks \(SYNTH 1, SYNTH 2, DX\)](#),” and “[8. SAMPLER Track](#).”

A pattern is a phrase that is played in a loop. You can play the same phrase repeatedly or switch between them at any time you like. The patterns on the 11 tracks will continue to play along with each other until the project is stopped.

5.1 Switching Patterns

You can switch patterns by turning a Track knob or pressing a Drum key. The timing can be set so that the pattern switches immediately or at a fixed cycle (Launch Quantize) from the start of playback (reserved switching). The default setting for Launch Quantize for reserved switching is a 16-step cycle from the start of playback.

5.1.1 Using a Track knob to switch patterns

Turn a Track knob to instantly switch between the patterns on that track.

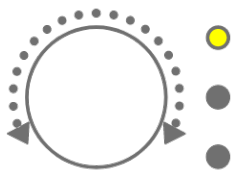

Press and turn a Track knob for reserved switching.

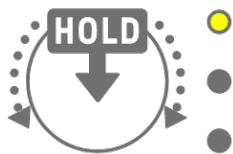

The LED lamp will flash in yellow for patterns 1–3, and in cyan blue for patterns 4–6.

Turn the [ALL] knob to instantly switch between the patterns on all 11 tracks. Press and turn the [ALL] knob to enable reserved switching on all 11 tracks.

5.1.2 Using a Drum key to switch patterns

Hold down a Track knob and press the Drum key that is lit for reserved switching. Drum keys 1–6 correspond to patterns 1–6.

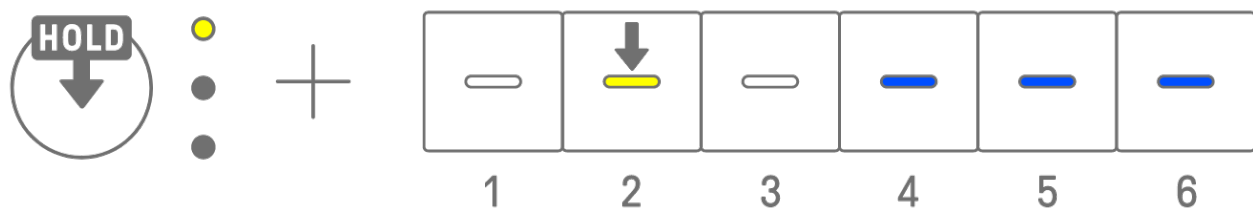

Hold down a Track knob and double-tap a Drum key to instantly switch between the patterns on that track.

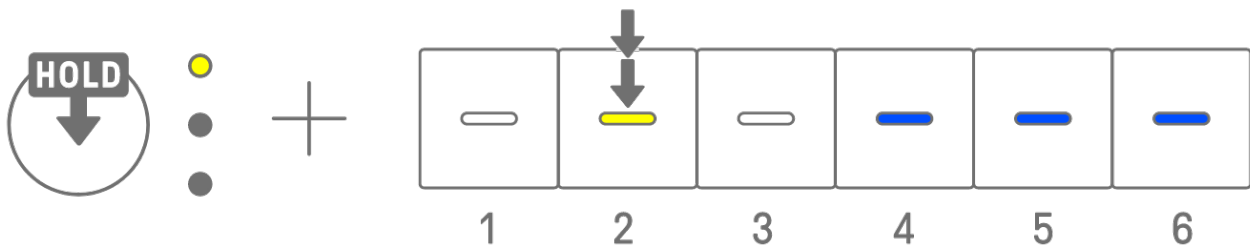

Hold down the [ALL] knob and double-tap a Drum key to instantly switch between the patterns on all 11 tracks. Hold down the [ALL] knob and press a Drum key to enable reserved switching on all 11 tracks.

5.1.3 Changing Launch Quantize

Hold down the [PROJECT ↑] button and turn the [ALL] knob to change the number of Launch Quantize steps. Press and turn the [ALL] knob to change the value in increments of one measure (16 steps). The number of measures is displayed on the Global Meter, and the number of steps is displayed on the Drum keys.

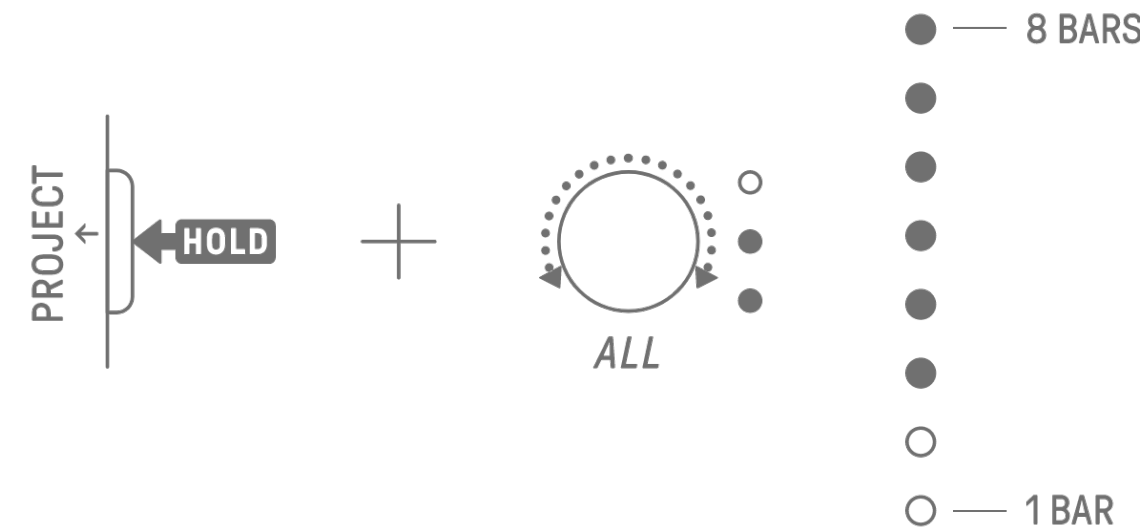

1	2	3	4	5	6	7	8
9	10	11	12	13	14	15	16

5.2 Changing the Length of a Pattern

5.2.1 Drum tracks

Hold down the [PAGE] button and turn a Drum Track knob to change the length of a pattern on a Drum track. The length can be set between 1 and 128 steps. Press and turn a Drum Track knob to change the value in increments of one measure (16 steps). The number of measures is displayed on the Global Meter, and the number of steps is displayed on the Drum keys.

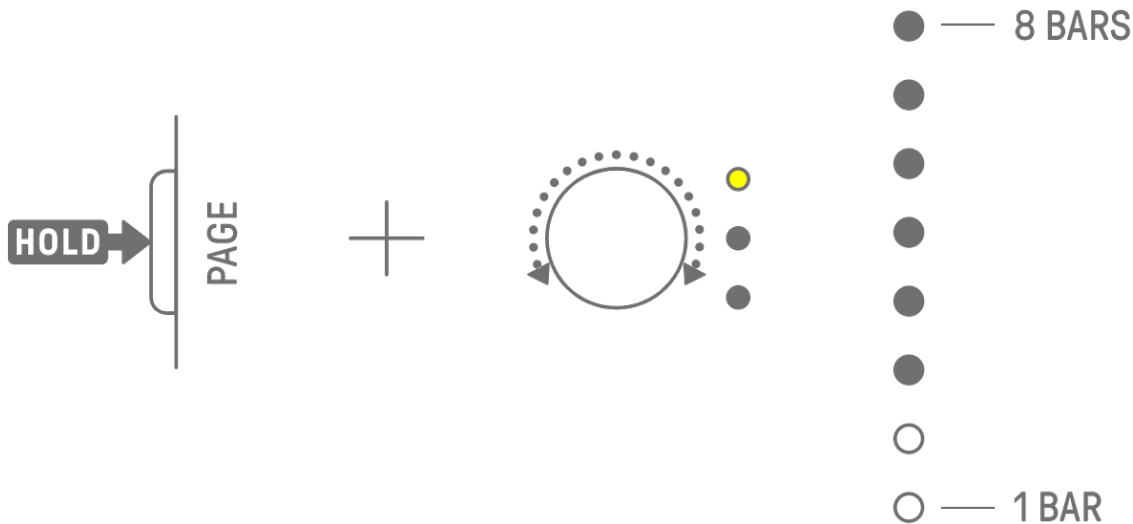

1	2	3	4	5	6	7	8
9	10	11	12	13	14	15	16

When a new measure is added, it is automatically copied from an existing measure. Check the table below to confirm which measure is copied first. [OS V1.20]

Additional Measure	Copied Measure
2nd measure	1st measure
3rd measure	1st measure
4th measure	2nd measure
5th measure	1st measure
6th measure	2nd measure
7th measure	3rd measure
8th measure	4th measure

NOTE

- When the length of a pattern is shortened, the data (note or Motion Recording) outside of the range are not lost but are properly retained. If the length of a pattern is restored, the data are restored.
- If the additional measure already has data, it will not be copied from the existing measure.

5.2.2 Synth tracks (SYNTH 1, SYNTH 2, DX), SAMPLER track

Press the [BAR LENGTH] button to change the length of a pattern on a Synth or SAMPLER track. The pattern length can be set to 1, 2, 4, or 8 bars.

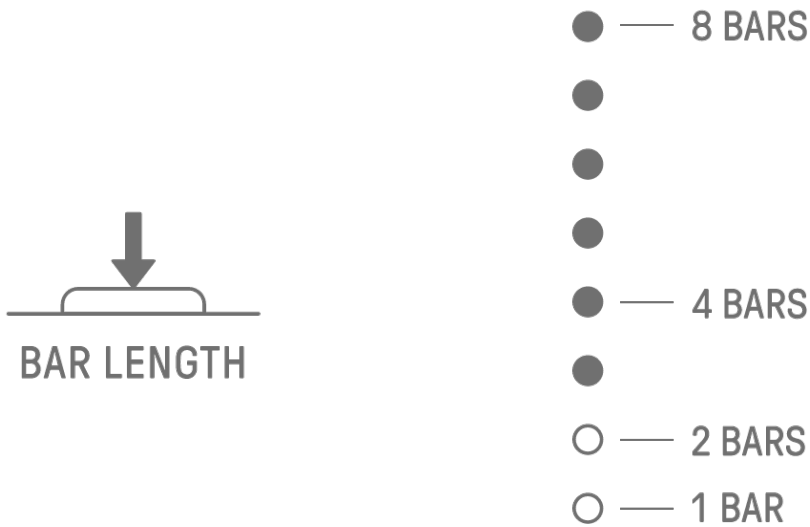

Hold down the [BAR LENGTH] button and turn a Synth Track knob or the [SAMPLER] knob to set the length of the pattern in steps of 1–128. Press and turn a Synth Track knob or the [SAMPLER] knob to change the value in increments of one measure (16 steps). The number of measures is displayed on the Global Meter, and the number of steps is displayed on the Drum keys.

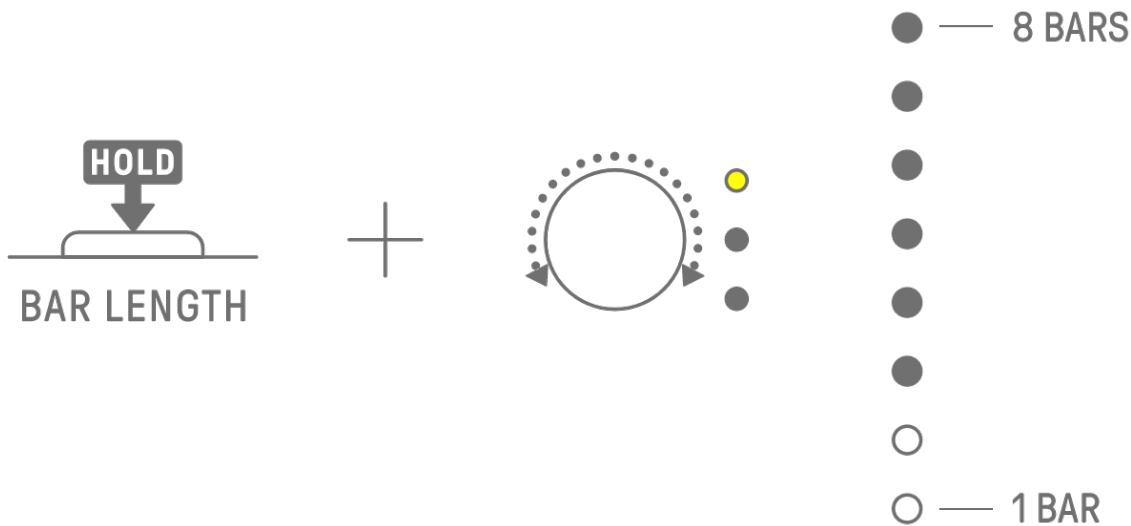

1	2	3	4	5	6	7	8
9	10	11	12	13	14	15	16

When a new measure is added, it is automatically copied from an existing measure. Check the table below to confirm which measure is copied first. [OS V1.20]

Additional Measure	Copied Measure
2nd measure	1st measure
3rd measure	1st measure
4th measure	2nd measure
5th measure	1st measure
6th measure	2nd measure
7th measure	3rd measure
8th measure	4th measure

NOTE

- When the length of a pattern is shortened, the data (note or Motion Recording) outside of the range are not lost but are properly retained. If the length of a pattern is restored, the data are restored.
- If the additional measure already has data, it will not be copied from the existing measure.

5.3 Changing the Number of Patterns (3 Patterns ⇔ 6 Patterns)

To increase the number of track patterns from three to six, hold down a Track knob and press Drum keys 4–6 lit in blue. When the number of patterns reaches six, Drum keys 4–6 light in white.

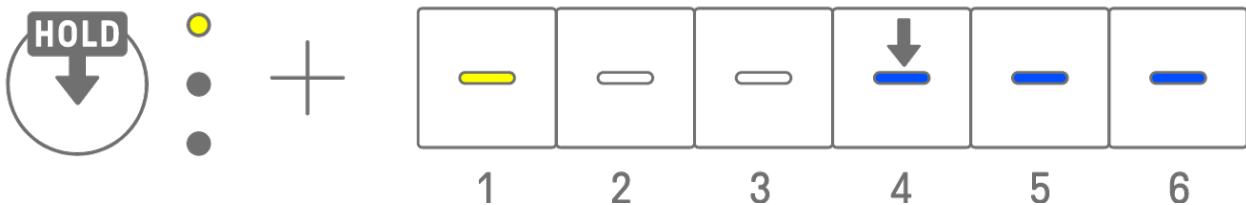

To reduce the number of track patterns from six to three, hold down a Track knob and press Drum keys 4–6 simultaneously. When the number of patterns reaches three, Drum keys 4–6 light in blue.

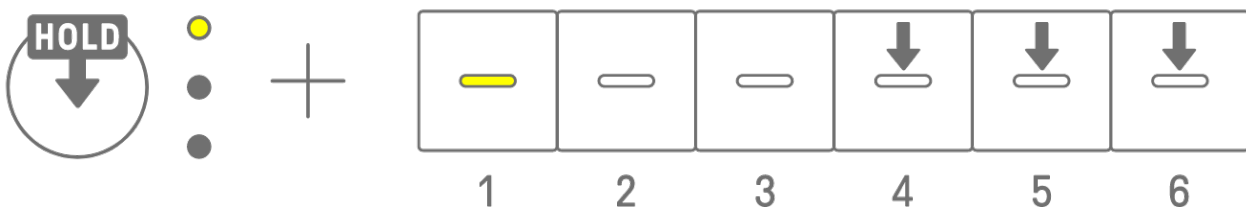

NOTE

- Press a Track knob and watch the LED lamps to check which pattern 1–6 is selected for that track. If patterns 1–3 are selected, the LED lamp flashes in yellow; if patterns 4–6 are selected, it flashes in cyan blue.

5.4 Deleting a Pattern

Hold down the [DELETE] button and press a Track knob to delete the currently selected pattern on that track. When the pattern has been deleted, the LED lamp of the target track flashes in red.



Hold down the [DELETE] button and press the [ALL] knob to delete the currently selected pattern on all tracks.

5.5 Copying and Pasting Patterns

To copy the currently selected pattern, press and hold the Track knob or the [ALL] knob while pressing a Drum key for at least 2 seconds. If copying is successful, the Global Meter flash in white.

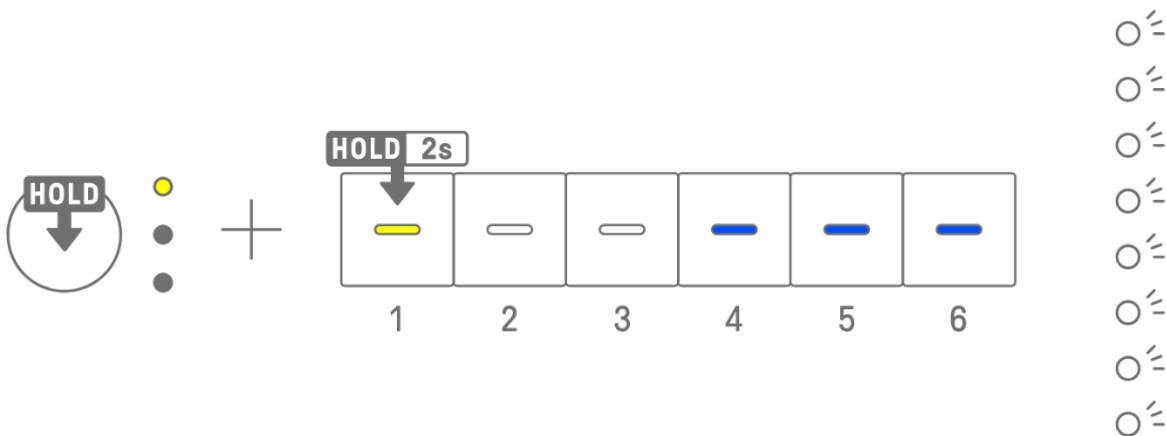

To paste a copied pattern, hold down the Track knob or [ALL] knob together with the [Page] button and press a Drum key. If pasting is successful, the Drum key that is the paste destination will flash for 1 second.

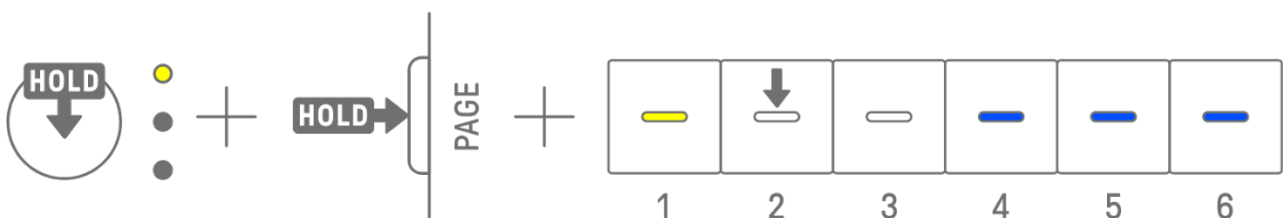

You can copy and paste to different tracks, as long as it is between Drum tracks or Synth tracks (SYNTH1, SYNTH2, and DX).

NOTE

- All parameters, including Parameter Locks and Motion Recording, can be copied and pasted as is. However, if the effect type differs between tracks, the effect parameters will not be pasted.

5.6 Selecting and Auditioning Tracks

Press a Track knob to select that track. Press a Track knob while playback is stopped to audition the sound of the selected track.

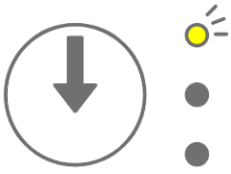

5.7 Changing the Sound of a Track

To change the sound of a Drum track or a Synth track (SYNTH 1, SYNTH 2, and DX), press a Track knob to select that track, then turn Sound Design knob 1 on Sound Design Page 1.

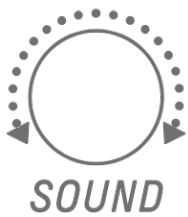

The SAMPLER track has samples assigned to each of the seven Synth keys. To change the sound of a sample, press the [SAMPLER] knob to select the SAMPLER track. Next, press a Synth key to select a sample, and then turn Sound Design knob 1 on Sound Design Page 1.

SAMPLER

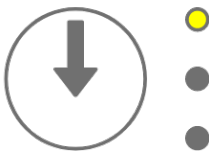

●	↓ 1	— 2	— 3
— 4	— 5	— 6	— 7



5.7.1 Selecting a sound category (category jump)

Hold down Sound Design knob 1 on Sound Design Page 1 and press a Drum key to go directly to the first sound in the sound category set for that track. This is called a category jump.

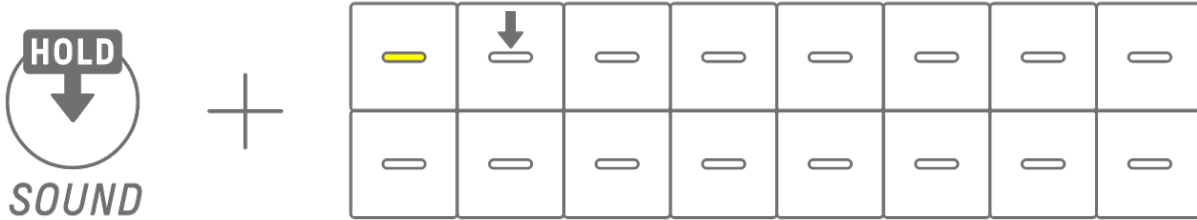

NOTE

- A category jump to FAVORITE allows you to select the sounds you have registered as your favorites. To register a sound as a favorite, see [“9.5 Saving a Sound.”](#)
- If a sound registered as a favorite does not exist, FAVORITE will not light up.

5.7.2 Drum track sound categories

KICK	SNARE	RIM	CLAP	SNAP	CLOSED HIHAT	OPEN HIHAT	SHAKER/TAMBOURINE
RIDE	CRASH	TOM	BELL	CONGA/BONGO	WORLD	SFX	FAVORITE

5.7.3 Synth track (SYNTH 1, SYNTH 2, and DX) sound categories

BASS	SYNTH LEAD	PIANO	KEYBOARD	ORGAN	PAD	STRINGS	BRASS
WOOD WIND	GUITAR	WORLD	MALLET	BELL	RHYTHMIC	SFX	FAVORITE

5.7.4 SAMPLER track sound categories

VOCAL COUNT	VOCAL PHRASE /CHANT	SINGING VOCAL	ROBOTIC VOCAL/EFFECT	RISER	LASER/SCI-FI	IMPACT	NOISE/DISTORTED SOUND
AMBIENT/SOUNDSCAPE	SFX	SCRATCH	NATURE/ANIMAL	HIT/STAB/MUSICAL INSTRUMENT SOUND	PERCUSSION	RECORDED SOUND	FAVORITE

5.8 Muting and Soloing a Track

5.8.1 Mute

Hold down the [MUTE] button and press a Track knob to mute the currently selected track. The LED lamp of the muted track will light in green. Press the knob again to unmute the track.



NOTE

- When any track is muted, hold down the [MUTE] button and press the [ALL] knob to instantly unmute all tracks.

5.8.2 Solo

Hold down the [SOLO] button and press a Track knob to solo that track and mute all other tracks. At this time, the LED lamp of the soloed track will light in cyan blue. Press the knob again to un-solo the track.



NOTE

- Mute and Solo can also be used in [Mixer mode](#) and [Song mode](#).
- If a track is soloed while it is muted, solo takes precedence. When the track is un-soloed, the mute status is restored.

5.9 Copying and Pasting Track Steps

To copy the steps of the currently selected track, press and hold a Drum key for at least 2 seconds. If copying is successful, the Global Meter flash in white.

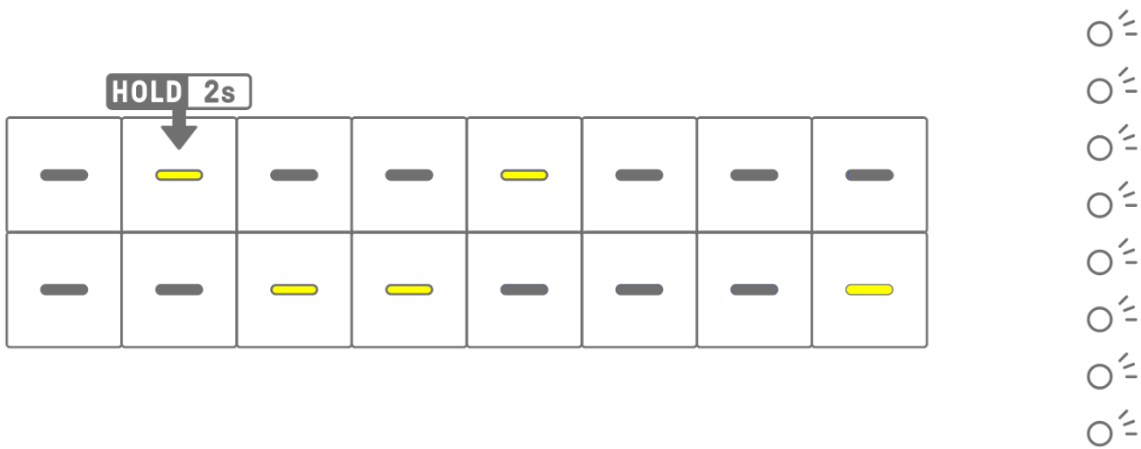

To paste the copied steps, hold down the [Page] button and press a Drum key.

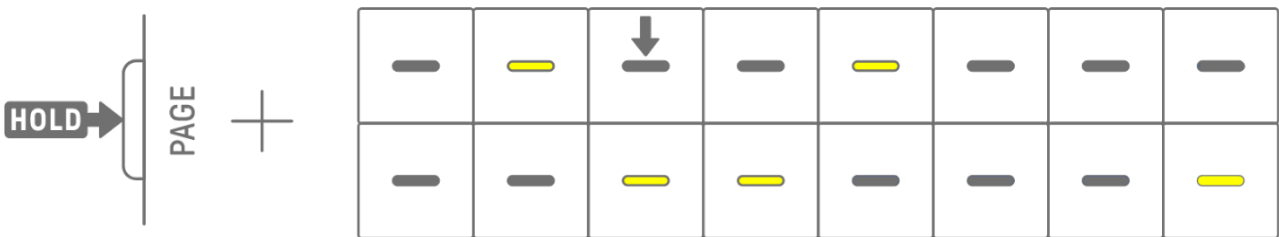

You can copy and paste to different tracks, as long as it is between Drum tracks or Synth tracks (SYNTH1, SYNTH2, and DX).

NOTE

- All parameters, including Parameter Locks and Motion Recording, can be copied and pasted as is. However, if the effect type differs between tracks, the effect parameters will not be pasted.

6. Drum Tracks

There are seven Drum tracks: KICK, SNARE, CLAP, HAT 1, HAT 2, PERC 1, and PERC 2. You can produce beats by operating the corresponding Track knobs and Drum keys.

6.1 Entering Steps

Press a Drum Track knob to select the Drum track you want to edit. Press a Drum key to turn that step on/off.

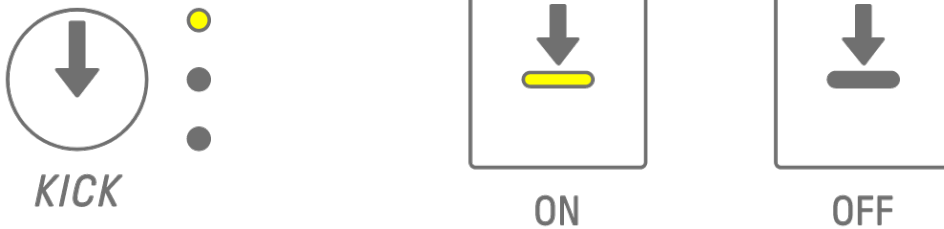

6.2 Switching Pages

Up to 16 steps of a pattern can be displayed on the Drum keys at the same time. This is called a page. If a pattern is 17 or more steps in length, you can switch pages.

Press the [PAGE] button to switch pages. The current page is indicated by a flashing cyan blue on the Global Meter.



NOTE

- To change the length of a pattern, see ["5.2 Changing the Length of a Pattern."](#)

6.3 Fine-tuning the Rhythmic Timing of a Step (Micro Timing)

Hold down a Drum key that is on and turn a Track knob to fine-tune the rhythmic timing of that step. At this time, [MICRO TIMING] lights up on the index.

Rhythmic timing can be adjusted in a range from -60 ticks to +59 ticks.

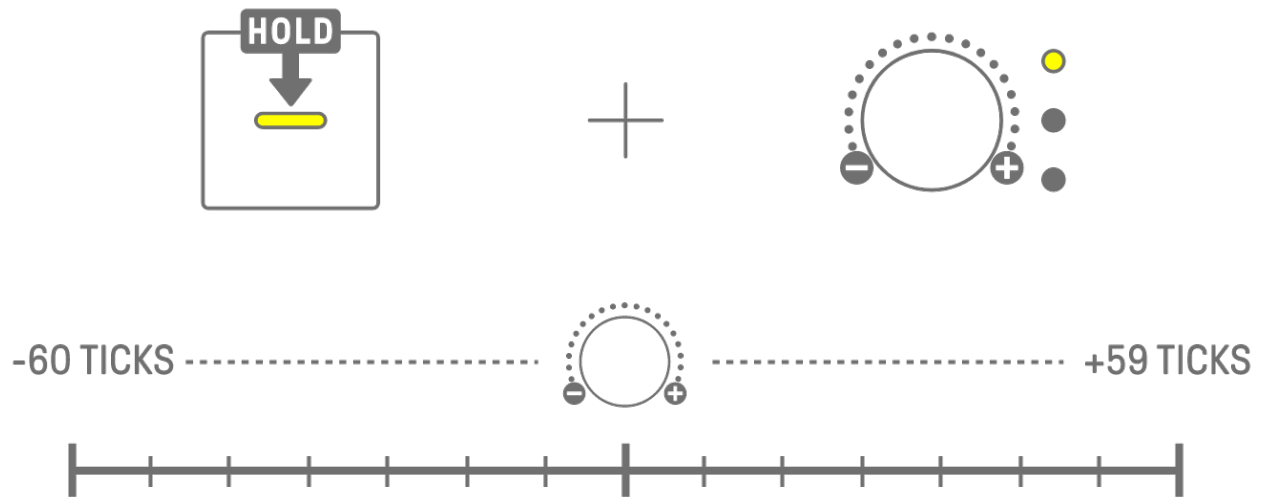

NOTE

- One step is 120 ticks.
- Hold down multiple Drum keys simultaneously and turn a Track knob to adjust the rhythmic timing of multiple steps.

6.4 Setting the Consecutive Number of Times a Step is Triggered (Substep)

Triggering a single step multiple times is called a Substep. If you press and hold a Drum key that is on for 2 seconds or longer, five Drum keys light up for setting the Substep. You can select No Substep (default), two times, three times (8th note triplet), three times, or four times.

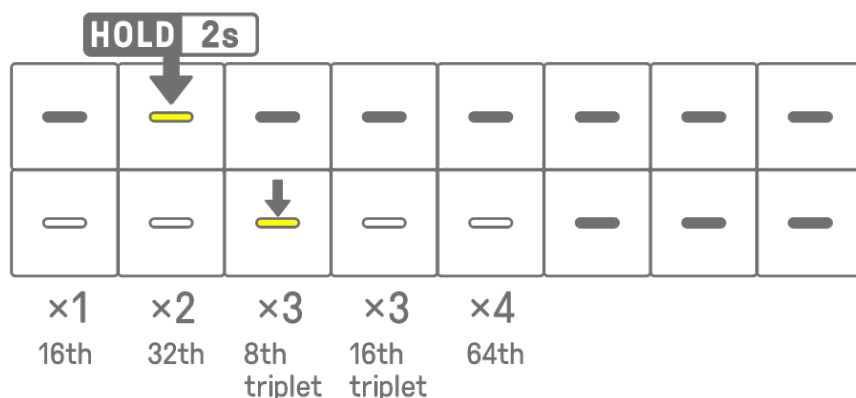

NOTE

- If the Drum key for which you want to set a Substep is on the upper row, five Drum keys on the lower row will light. If it is on the lower row, five Drum keys on the upper row will light.

6.5 Real-time Input

Hold down one of the Drum Track knobs and press a Synth key to enter Real-time Input mode. In Real-time Input mode, the Synth keys can be used to play Drum tracks in real time. Use the same procedure to exit from Real-time Input mode.

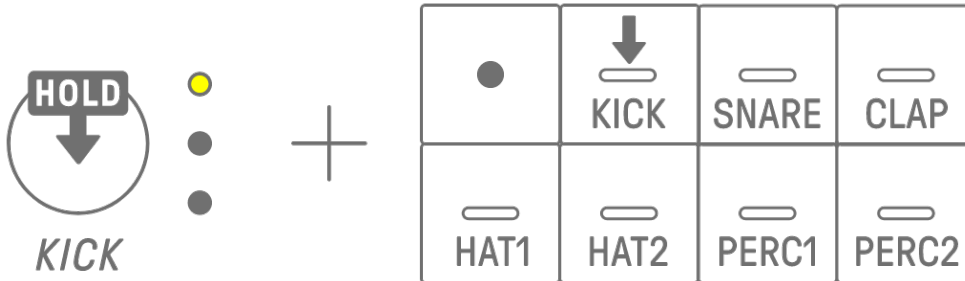

When in Real-time Input mode, press the Record key to start recording. You can record the sounds (note) of the Drum tracks for the Synth keys you press. While recording, the Record key flashes in red and the pattern is displayed on the Drum keys.

NOTE

- When the power is turned off, Real-time Input mode is automatically disabled.
- [When a count-in is set](#), the count-in will be played before recording begins. [OS V1.20]

6.6 Changing the Probability of Triggering a Step

The probability of triggering the steps of a Drum track can be selected from 8 levels. Hold down a Drum key that is on and press the [MUTE] button to reduce the probability of triggering that step by one level. At this time, the probability of triggering that step is indicated by the number of lights on the Global Meter.

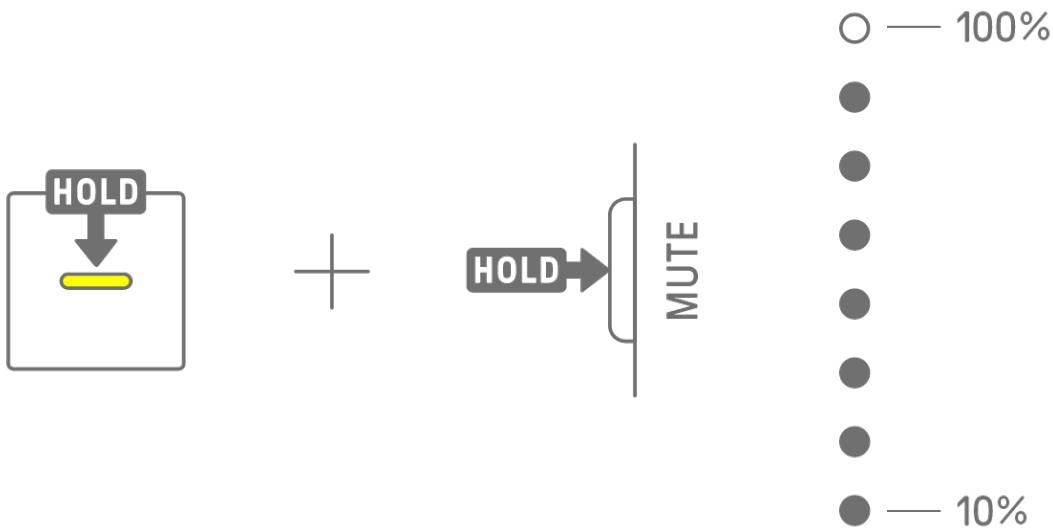

Hold down multiple Drum keys that are on and press the [MUTE] button to reduce the probability of triggering those steps by one level.

NOTE

- If the probability for triggering a step is changed when it is at the minimum level, it moves to the maximum level.
- When multiple steps are changed at the same time, the Global Meter indicates the highest probability level.

7. Synth Tracks (SYNTH 1, SYNTH 2, DX)

There are three Synth tracks: SYNTH 1, SYNTH 2, and DX. You can produce melodies by operating the corresponding Track knobs and Synth keys.

7.1 Real-time Input

Press the [SYNTH 1] knob, [SYNTH 2] knob, or [DX] knob to select a Synth track.

Press the Synth keys to play in real time.

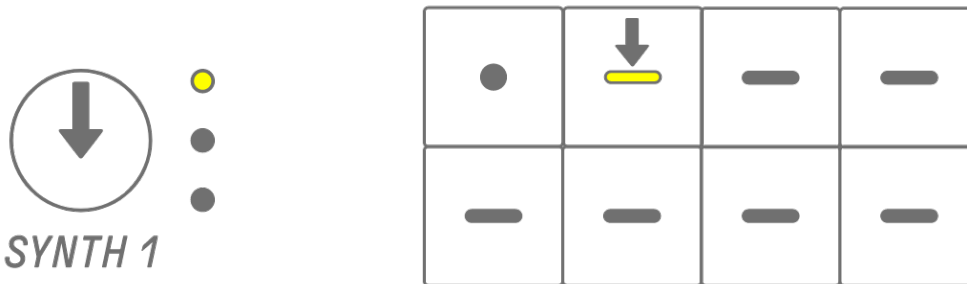

Press the Record key to start recording. You can record the sounds (notes) of the Synth keys you press.

While recording, the Record key flashes in red and the current position in the pattern is displayed on the Drum keys.

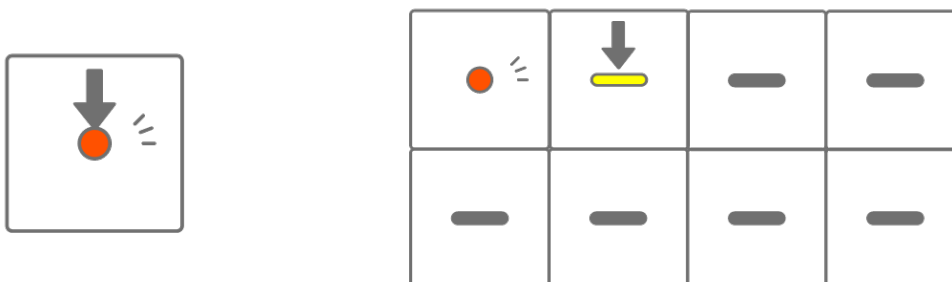

NOTE

- Real-time input is also possible from external MIDI devices. For details about channel assignments, see ["18.2 MIDI Channels."](#)
- You can record overdubs while leaving previously recorded notes in place. However, if you record a note with the same pitch as a previously recorded note, the length of the previously recorded note will be rewritten.
- [When a count-in is set](#), the count-in will be played before recording begins. [OS V1.20]

7.2 Turning Quantize On/Off

To turn quantize on/off while recording, hold down the [ALL] knob and press the Record key. The Global Meter lights up white when quantize is on and turns off when quantize is off. This is set to on by default.

When quantize is on, the recorded data will be corrected automatically if your rhythmic timing is off during a performance.

Quantize does not affect previously recorded data.

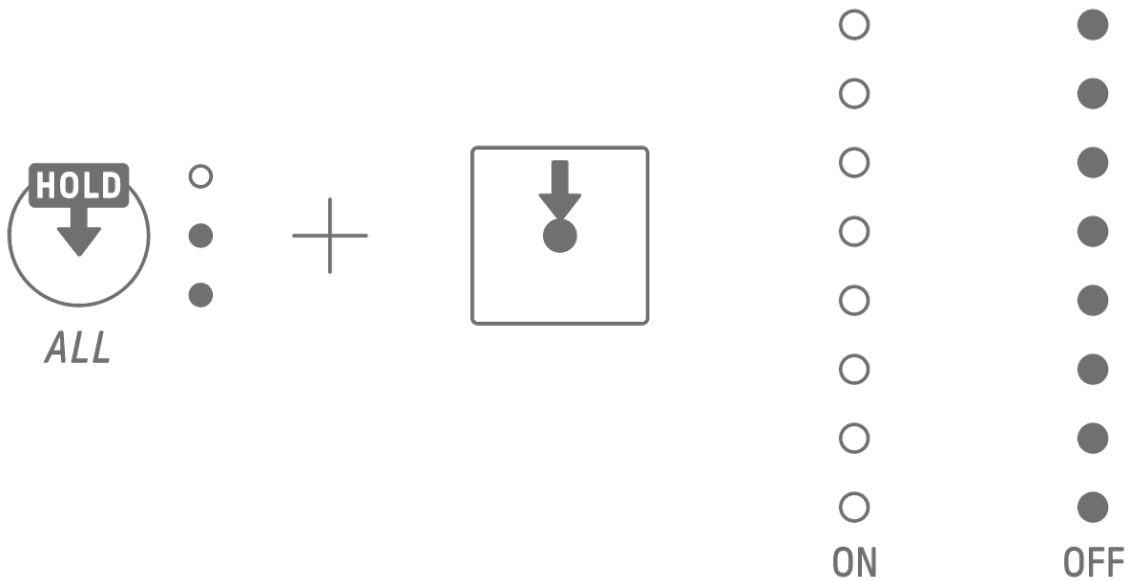

NOTE

- Use the SEQTRAK app to make advanced quantize settings. Quantize can be set to 1/32, 1/16T, 1/16 (default), 1/8T, 1/8, or OFF.
- Quantize settings are also applied during real-time input for Drum tracks.

7.3 Changing the Octave

Press the [OCTAVE] button to change the pitch of the currently selected Synth key by one octave. The octave can be changed within a range of +2 to -3 octaves. This operation does not affect previously recorded data.



7.4 Changing the Scale

Press the [SCALE] button to change the scale that is used when the Synth keys are pressed. Eight different scales are stored for each project. The default settings are shown in the figure below. This operation does not affect previously recorded data.

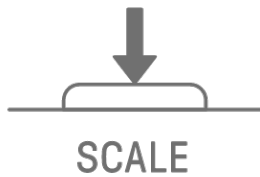

- MINOR
- MAJOR
- MINOR PENTATONIC
- MAJOR PENTATONIC
- LYDIAN
- DORIAN
- MIXOLYDIAN
- PHRYGIAN

NOTE

- You can use the SEQTRAK app to edit the scale of the currently selected project.

7.5 Changing the Key

Press the [KEY] button to change in half steps the key that is used when the Synth keys are pressed. This operation does not affect previously recorded data.

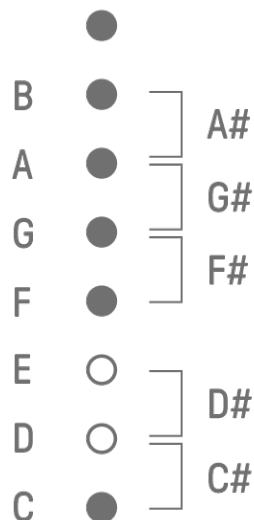
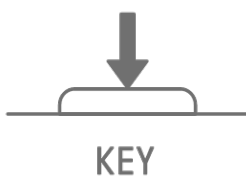

7.6 Playing Chords

Turn Sound Design knob 2 on Sound Design Page 1 to switch between the MONO, POLY, and CHORD settings. For the CHORD setting, seven chords have been assigned. The MONO/POLY/CHORD settings can be enabled for the SYNTH 1, SYNTH 2, and DX tracks.

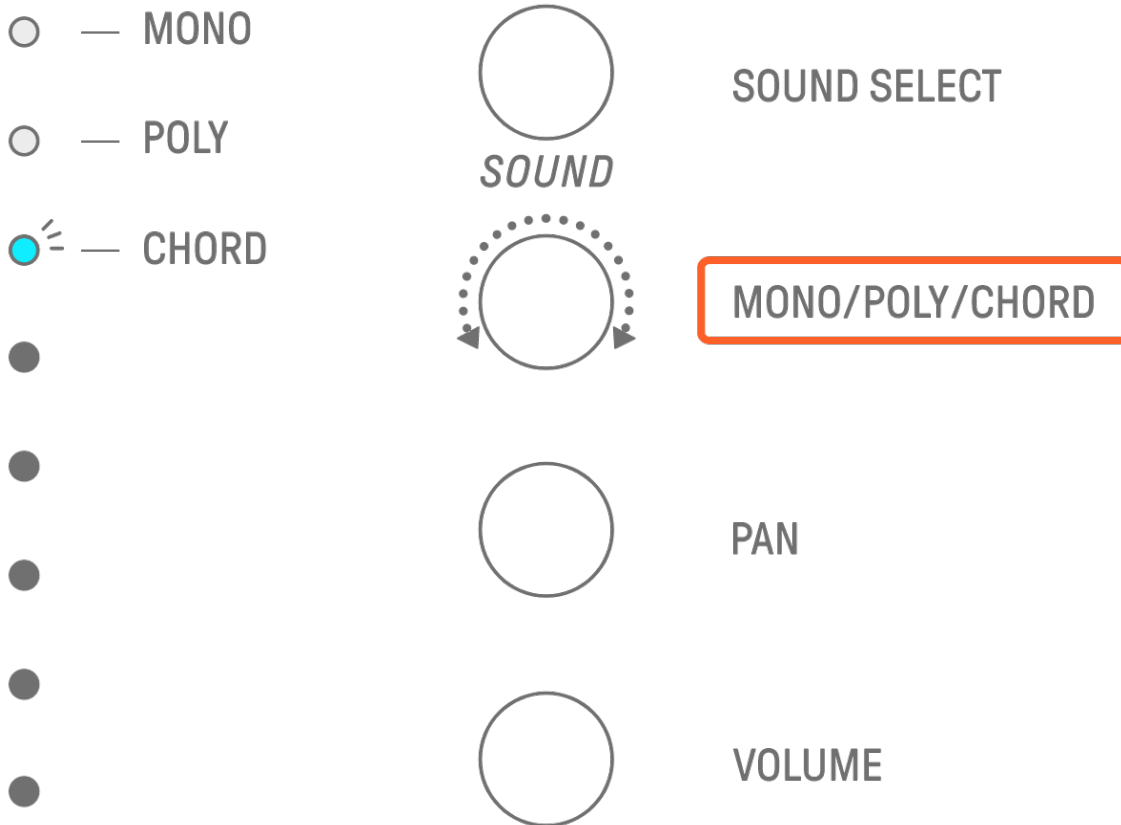

7.7 Editing Chords

Use the following procedure to edit the chords.

1. Turn Sound Design knob 2 on Sound Design Page 1 to select CHORD.
2. Hold down the [ALL] knob and press the Synth key of the chord you want to edit. The notes that make up that chord will be displayed on the Drum keys. Press the [OCTAVE] button or press any of the Drum keys that are lit in blue to change the displayed range of notes.
3. Press the Drum keys to add or remove notes. You can select up to four notes. Press a Synth key to audition the chord of the selected notes.

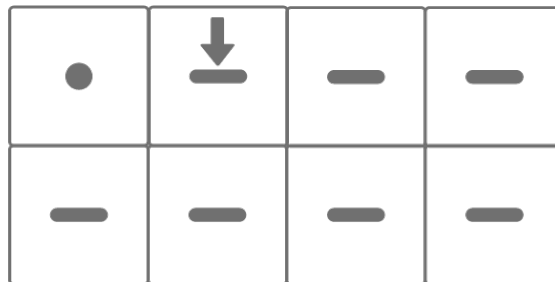
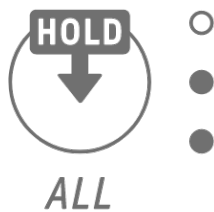
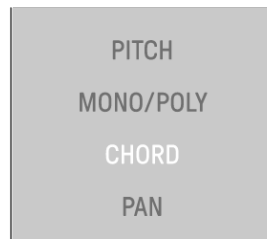
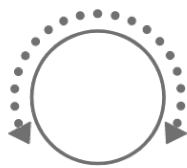

	C#	D#		F#	G#	A#	
C	D	E	F	G	A	B	C

This operation does not affect previously recorded data.

NOTE

- The notes that make up a chord can also be edited in the SEQTRAK app.
- Chords can be set for each track, and they are linked to the scale for that project.
- If a note in a key, scale, or chord is above G8, the note one octave lower is played (for example, A7 for A8).

7.8 Switching to Keyboard Input Mode

In the Keyboard Input mode, you can play the Drum keys as if they were a keyboard. Hold down the [ALL] knob and press the [KEY] button to switch to Keyboard Input mode. At this time, the Drum keys light in white in the shape of a keyboard.



	C#	D#		F#	G#	A#	
C	D	E	F	G	A	B	C

NOTE

- Press the [OCTAVE] button or press any of the Drum keys that are lit in blue to change the displayed range of notes.

7.9 Entering Steps

Synth tracks can be edited by entering steps.

Hold down the [PAGE] button and press the Synth Track knob or the [SAMPLER] knob to enter Step Input mode. Use the same procedure to exit Step Input mode.



Press a Drum key to turn the corresponding step on/off. The step contains the last note played via Synth key/keyboard input mode/external MIDI device for the currently selected track. If multiple notes are played simultaneously, such as when MONO/POLY/CHORD is set to CHORD, all selected notes are entered for that step.

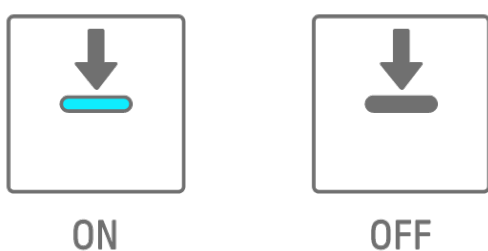

Hold down a Drum key and press a Synth key to add or remove notes assigned to the Synth key to/from the selected step. If MONO/POLY/CHORD is set to CHORD, all notes already entered are deleted and notes of the chord are added. If the notes entered exactly match the notes of the chord, all notes are deleted.

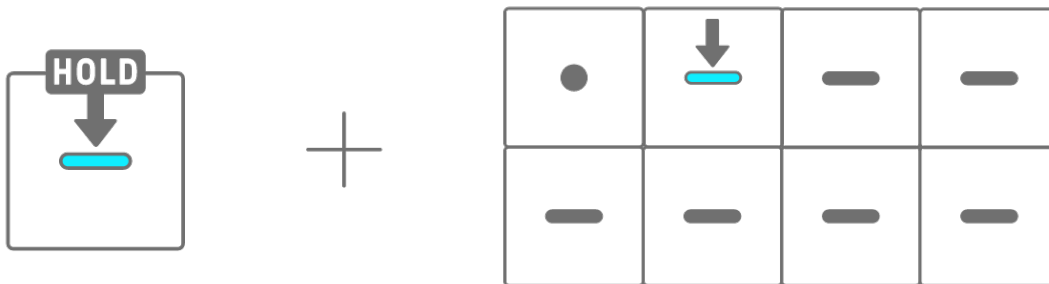

To change the length of the notes of the selected step, simultaneously press and hold a Drum key that is on and turn the [ALL] knob. If the selected step has multiple notes, simultaneously press and hold the Drum and Synth keys and turn the [ALL] knob to change the length of individual notes.

The length of the note is indicated by the Drum keys and the Global Meter.



1	2	3	4	5	6	7	8
9	10	11	12	13	14	15	16



NOTE

- When the power is turned off, Step Input mode is automatically disabled.
- In Step Input mode, you can change the [Micro Timing](#) of notes.

8. SAMPLER Track

The SAMPLER track is used for playing audio samples. Preset samples or samples recorded with the built-in microphone, among other options, can be assigned to the Synth keys for playback.

8.1 Real-Time Input

Press the [SAMPLER] knob to select the SAMPLER track.

The SAMPLER track can play up to seven samples. Press a Synth key to play the sample assigned to that key.

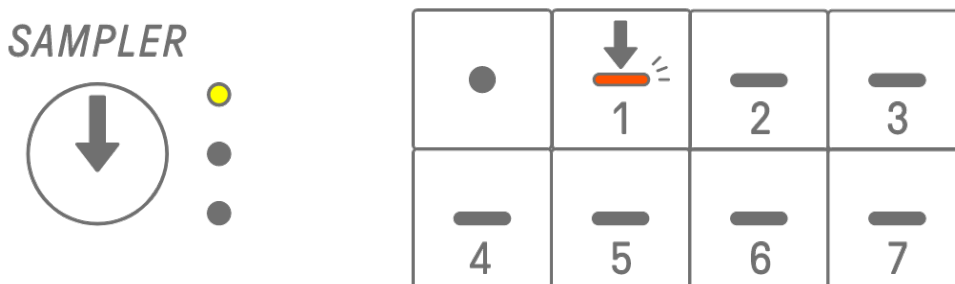

Press the Record key to start recording. You can record the samples assigned to the Synth keys. While recording, the Record key flashes in red and the current position in the pattern is displayed on the Drum keys.

8.2 Sampling (Built-In Microphone/AUDIO IN and USB Audio Input)

Sounds that have been recorded with the built-in microphone or imported from an external device can be played on the SAMPLER track. Press the [SAMPLER] knob to select the SAMPLER track. Press the Synth key to which the sound to be sampled will be assigned. At this time, the selected Synth key flashes in red.

Press the [REC SAMPLE] button to start sampling with the microphone. The recording time for each sample is up to 16 seconds. To end sampling, press the [REC SAMPLE] button again or let the full 16 seconds elapse.

If a cable is connected to the [AUDIO IN] jack, sampling is performed for the AUDIO IN input. If the sampling source is USB audio input, audio that is input via the USB connection will be sampled.

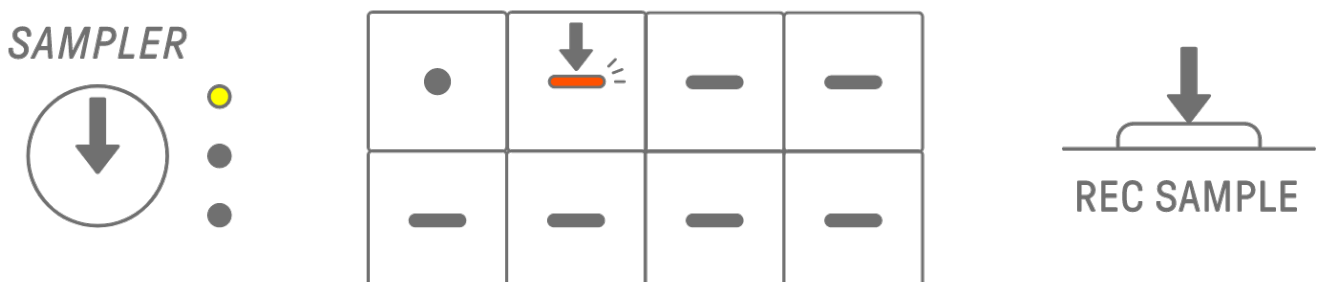

8.3 Changing the Sampling Source

You can select from three sampling sources: built-in microphone/AUDIO IN input, USB audio input, or resampling. To change the sampling source, Hold down the [REC SAMPLE] button for at least 2 seconds and press the Drum key that is lit in white.



8.4 Resampling

Resampling is the process of sampling audio directly from the SEQTRAK as it is being played by the device. Use the following procedure for resampling.

1. Change the sampling source to resampling. For details about how to change the sampling source, see [“8.3 Changing the Sampling Source.”](#)
2. Change and adjust the pattern on each track.
3. Start sampling. For details about how to sample, see [“8.2 Sampling \(Built-In Microphone/AUDIO IN and USB Audio Input\).”](#)

NOTE

- The metronome is muted while resampling, regardless of the setting.

8.5 Canceling Sampling

Sampling can be canceled while it is in progress. To cancel sampling, Hold down the [DELETE] button and press the [REC SAMPLE] button. After sampling is canceled, the sounds are restored to their previous state before sampling.



8.6 Setting the Count-In to Start Sampling

To set the count-in to start sampling, hold down the [ALL] knob and press the [REC SAMPLE] button. The count-in setting is enabled when the sampling source is set to built-in microphone/AUDIO IN input or USB audio input. The Global Meter lights up in white when count-in is on and turns off when count-in is off.



NOTE

- This setting is linked to the setting of the pre-recording count-in in Real-time Input mode. [OS V1.20]

8.7 Switching to Monitoring Mode

In Monitoring mode, you can use the Global Meter to check the loudness of the sampling input audio. Hold down the [REC SAMPLE] button and press the [VOL+] button to switch to Monitoring mode. When switched to Monitoring mode, the three LEDs on the SAMPLER track flash in white. Use the same procedure to exit Monitoring mode.

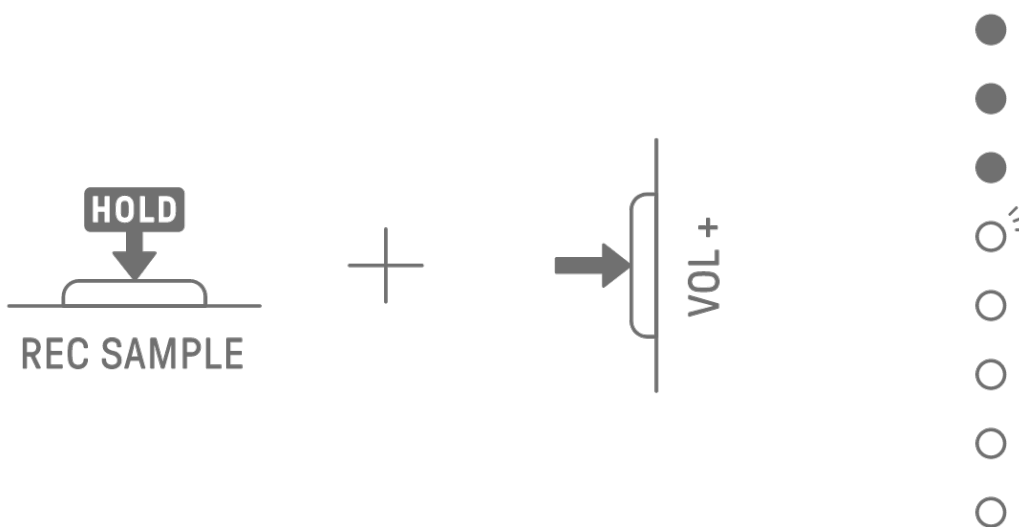

8.8 Turning Auto-Normalize On/Off

The auto-normalize function automatically maximizes the volume of sampled audio. This is set to on by default. You can use the SEQTRAK app to turn auto-normalize on/off.

8.9 Deleting Patterns for Each Sample

Press the [SAMPLER] knob to select the SAMPLER track. Hold down the [DELETE] button and press a Synth key to delete the pattern for that sample.



8.10 Entering Steps

The SAMPLER track can be edited by entering steps.

Hold down the [PAGE] button and press the Synth Track knob or the [SAMPLER] knob to enter Step Input mode. Use the same procedure to exit Step Input mode.





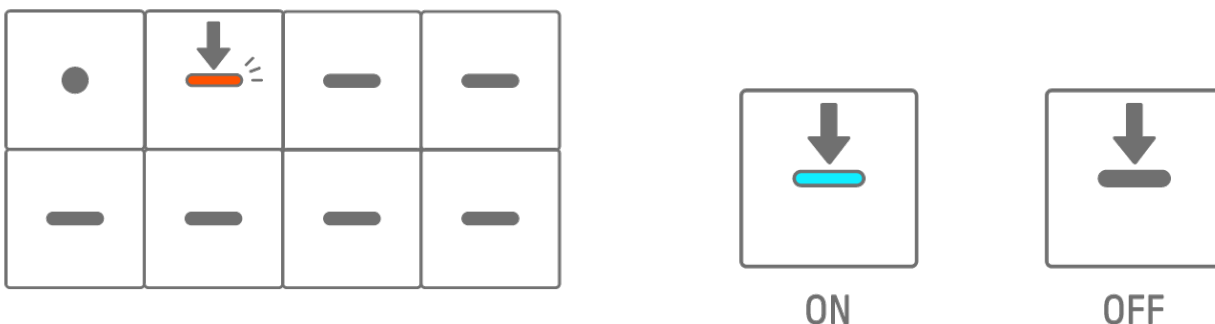









Press the [SAMPLER] knob to select the SAMPLER track. Press a Synth key to select the sample to be edited. Press a Drum key to turn that step on/off. The Drum key displays only the data for the selected sample.



Hold down a Drum key that is on and turn the [ALL] knob to change the length of the notes of the selected step. The length of the note is indicated by the Drum keys and the Global Meter.



 1	 2	 3	 4	 5	 6	 7	 8
 9	 10	 11	 12	 13	 14	 15	 16



NOTE

- When the power is turned off, Step Input mode is automatically disabled.
- In Step Input mode, you can change the [Micro Timing](#) of notes.

8.11 Muting samples [OS V1.20]

Press the [SAMPLER] knob to select the SAMPLER track. Hold down the [MUTE] button and press a Synth key to mute the sample assigned to that Synth key. The Synth key of the muted sample lights up in green. Use the same procedure to unmute a sample.

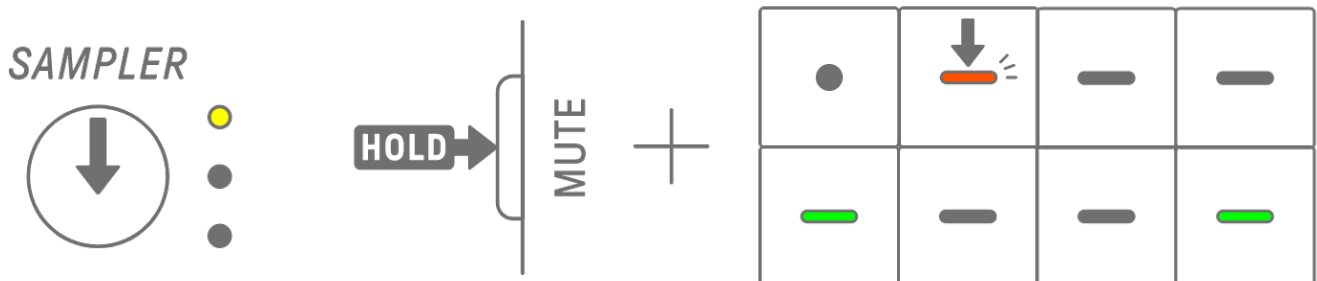

NOTE

- When the SAMPLER track is muted, no sound is made regardless of the mute status of the sample.
- Unmuting the SAMPLER track or unmuting all tracks at once does not unmute the sample.

9. Sound Design

9.1 Adjusting Sound Parameters

Press a Track knob to select the track for which you want to adjust the sound parameters. Turn Sound Design knobs to adjust the sound parameters of the selected track. To make greater changes to the parameters, simultaneously press and turn the Sound Design knobs. The sound parameters to be adjusted are displayed in the index.

- SOUND
- PITCH
- MONO/POLY
- CHORD
- PAN
- VOLUME
- ATTACK
- DECAY
- MICROTIMING
- FILTER
- RESONANCE

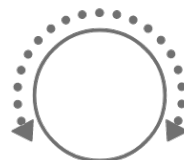
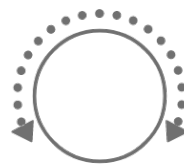
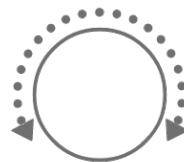

9.1.1 Switching between the sound parameter operation pages

Press the Sound Design Page button to switch between the sound parameter operation pages. Different sound parameters are assigned to each page.

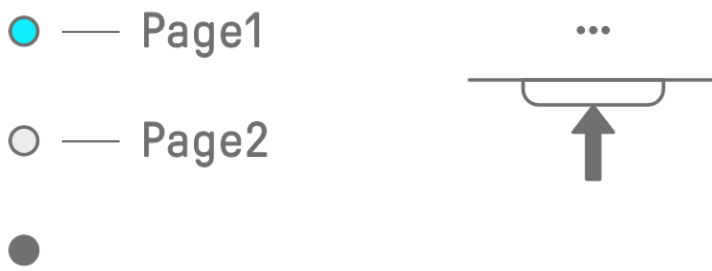

Press and hold the Sound Design Page button for at least 2 seconds to enter the advanced settings. Use the same procedure to exit the advanced settings. In the advanced settings, more operation pages and sound parameters are available.

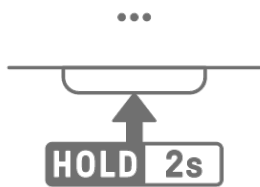

9.1.2 Drum track sound parameters

Page	Sound Design Knob	Parameter	Parameter Lock/ Motion Recording	Index Display
1	1	SOUND SELECT	-	SOUND
	2	PITCH	✓	PITCH
	3	PAN	✓	PAN
	4	VOLUME	✓	VOLUME
2	1	AEG ATTACK	✓	ATTACK
	2	AEG DECAY	✓	DECAY
	3	LP-HP FILTER CUTOFF	✓	FILTER
	4	LP-HP FILTER RESONANCE	✓	RESONANCE
3 (ADVANCED)	1	REVERB SEND	✓	REVERB
	2	DELAY SEND	✓	DELAY
	3	EQ HIGH GAIN	✓	OTHER
	4	EQ LOW GAIN	✓	OTHER

9.1.3 Synth track (SYNTH 1 and SYNTH 2) sound parameters

Page	Sound Design Knob	Parameter	Parameter Lock/ Motion Recording	Index Display
1	1	SOUND SELECT	-	SOUND
	2	MONO/POLY/CHORD	-	MONO/POLY CHORD
	3	PAN	✓	PAN
	4	VOLUME	✓	VOLUME
2	1	AEG ATTACK	✓	ATTACK
	2	AEG DECAY/RELEASE	✓	DECAY
	3	LP-HP FILTER CUTOFF	✓	FILTER
	4	LP-HP FILTER RESONANCE	✓	RESONANCE
3 (ADVANCED)	1	REVERB SEND	✓	REVERB
	2	DELAY SEND	✓	DELAY
	3	EQ HIGH GAIN	✓	OTHER
	4	EQ LOW GAIN	✓	OTHER
4 (ADVANCED)	1	PORTAMENTO TIME	✓	OTHER
	2	ARPEGGIATOR TYPE	-	OTHER
	3	ARPEGGIATOR GATE TIME	✓	OTHER
	4	ARPEGGIATOR SPEED	-	OTHER

NOTE

- If a Synth track is in [Step Input mode](#) and [Parameter Lock](#) is enabled, [PITCH] will light up instead of [MONO/POLY] and [CHORD]. At this time, you can change the pitch (note number) of the note for the selected step in half steps.

9.1.4 Synth track (DX) sound parameters

Page	Sound Design Knob	Parameter	Parameter Lock/ Motion Recording	Index Display
1	1	SOUND SELECT	-	SOUND
	2	MONO/POLY/CHORD	-	MONO/POLY CHORD
	3	PAN	✓	PAN
	4	VOLUME	✓	VOLUME
2	1	AEG ATTACK	✓	ATTACK
	2	AEG DECAY	✓	DECAY
	3	LP-HP FILTER CUTOFF	✓	FILTER
	4	LP-HP FILTER RESONANCE	✓	RESONANCE
3 (ADVANCED)	1	REVERB SEND	✓	REVERB
	2	DELAY SEND	✓	DELAY
	3	EQ HIGH GAIN	✓	OTHER
	4	EQ LOW GAIN	✓	OTHER
4 (ADVANCED)	1	PORTAMENTO TIME	✓	OTHER
	2	ARPEGGIATOR TYPE	-	OTHER
	3	ARPEGGIATOR GATE TIME	✓	OTHER
	4	ARPEGGIATOR SPEED	-	OTHER
5 (ADVANCED)	1	FM ALGORITHM	✓	OTHER
	2	MODULATOR AMOUNT	✓	OTHER
	3	MODULATOR FREQUENCY	✓	OTHER
	4	MODULATOR FEEDBACK	✓	OTHER

NOTE

- If a Synth track is in [Step Input mode](#) and [Parameter Lock](#) is enabled, [PITCH] will light up instead of [MONO/POLY] and [CHORD]. At this time, you can change the pitch (note number) of the note for the selected step in half steps.

9.1.5 SAMPLER track sound parameters

Page	Sound Design Knob	Parameter	Parameter Lock/ Motion Recording	Index Display
1	1	SOUND SELECT	-	SOUND
	2	PITCH	✓	PITCH
	3	PAN	✓	PAN
	4	VOLUME	✓	VOLUME
2	1	AEG ATTACK	✓	ATTACK
	2	AEG DECAY	✓	DECAY
	3	LP-HP FILTER CUTOFF	✓	FILTER
	4	LP-HP FILTER RESONANCE	✓	RESONANCE
3 (ADVANCED)	1	REVERB SEND	✓	REVERB
	2	DELAY SEND	✓	DELAY
	3	EQ HIGH GAIN	✓	OTHER
	4	EQ LOW GAIN	✓	OTHER
4 (ADVANCED)	1	START POINT	-	OTHER
	2	END POINT	-	OTHER
	3	LOOP ON/OFF	-	OTHER
	4	LOOP LENGTH	-	OTHER
5 (ADVANCED)	1	PEG ATTACK LEVEL	✓	OTHER
	2	PEG ATTACK TIME	✓	OTHER
	3	PEG DECAY LEVEL	✓	OTHER
	4	PEG DECAY TIME	✓	OTHER

NOTE

- For a description of each sound parameter, see [“18.7 Description of Sound Parameters.”](#)

9.2 Setting Sound and Effect Parameters for Each Step (Parameter Lock)

You can set the sound design and single effect parameters for each step (Parameter Lock). Hold down a Drum key that is on and turn Sound Design knobs 1–4 or sliding the [FX LEVEL] touch slider to enable Parameter Lock for that step. Steps for which Parameter Lock is enabled are lit in purple.

For details about parameters for which Parameter Lock can be enabled, see [“9.1 Adjusting Sound Parameters.”](#)

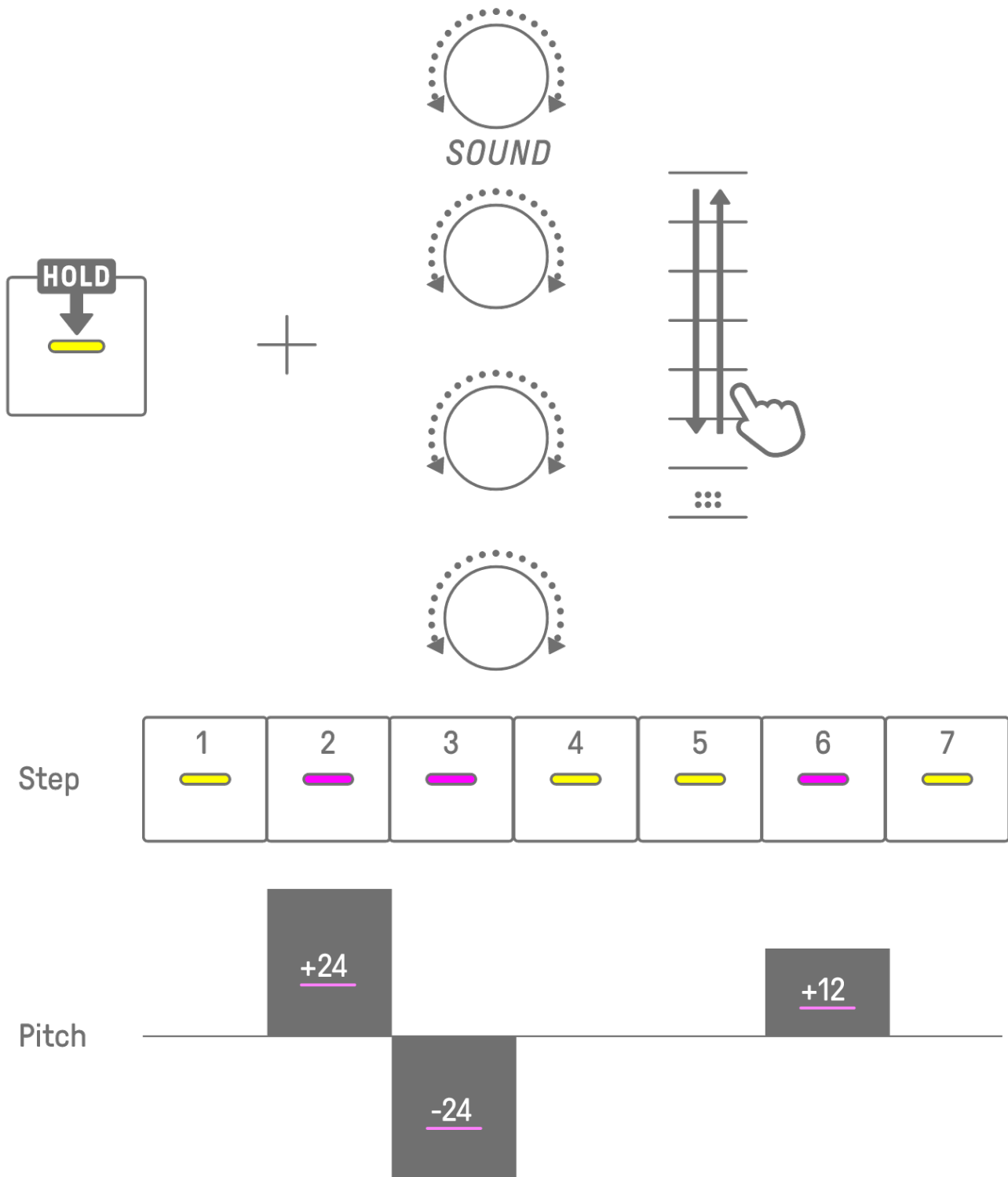

NOTE

- Hold down multiple Drum keys and turn Sound Design knobs 1–4 or sliding the [FX LEVEL] touch slider to enable Parameter Lock for the selected steps.
- If you enable Parameter Lock for VOLUME, the velocity of the note will change.

9.2.1 Deleting a Parameter Lock

To delete the Parameter Lock of the selected pattern, hold down the [DELETE] button and press the Sound Design knob or the [FX] knob. The parameter for the corresponding knob is deleted.

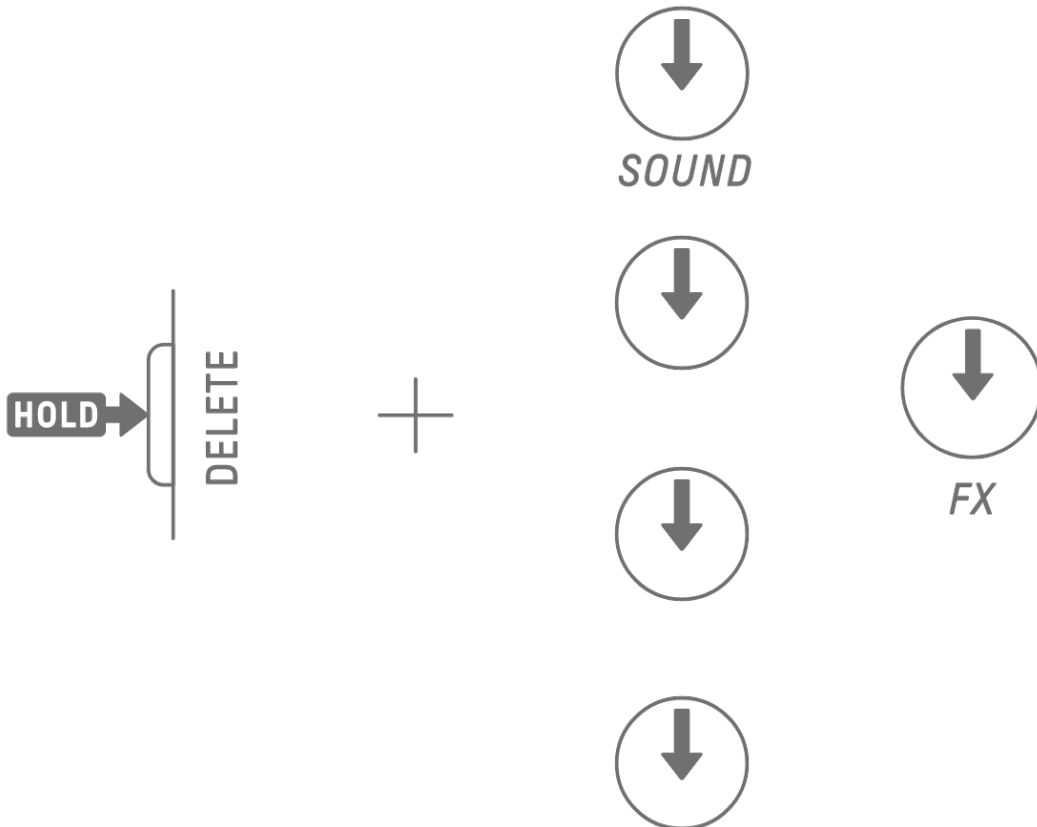

To delete the Parameter Lock of the selected step, press and hold the Drum key and the [DELETE] button and simultaneously press the Sound Design knob or the [FX] knob. The parameter for the corresponding knob is deleted for only the selected step.

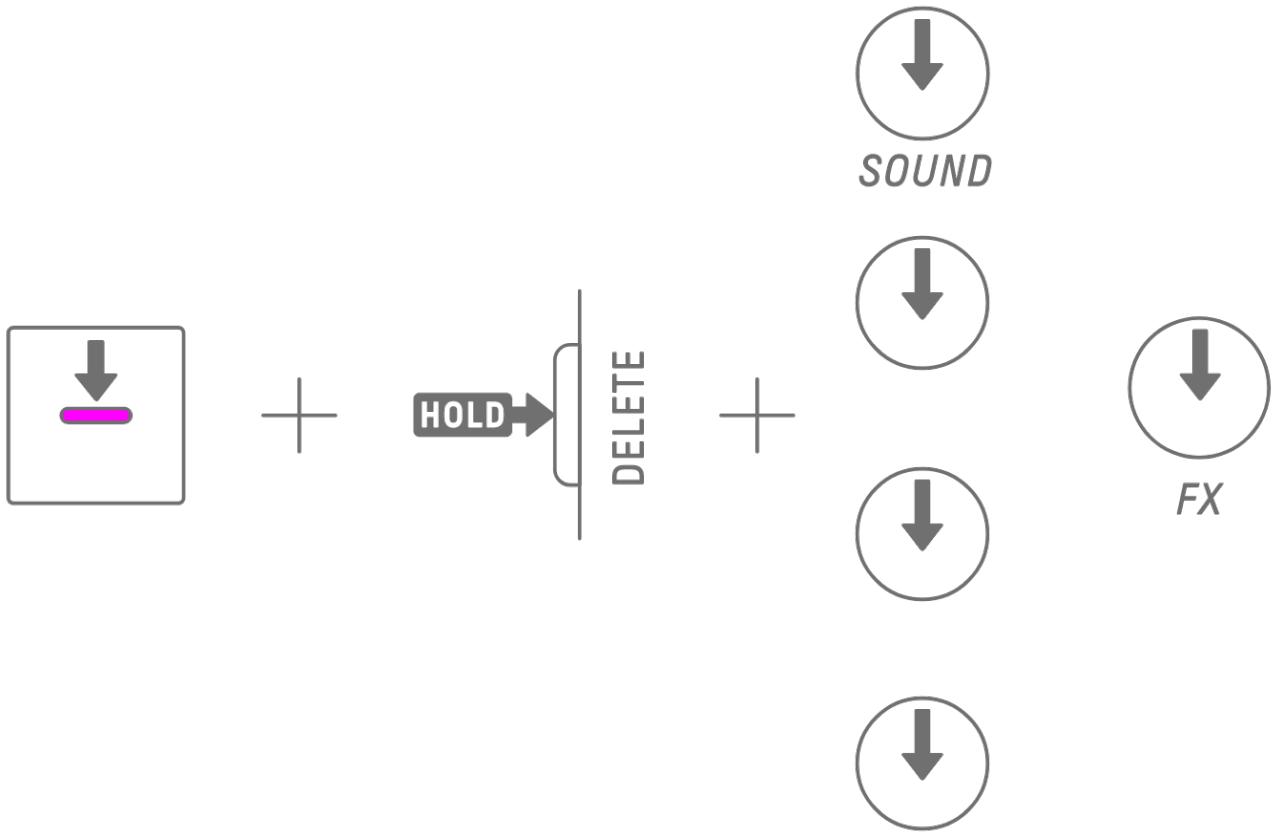

Turning a step OFF removes all Parameter Locks for the selected step.

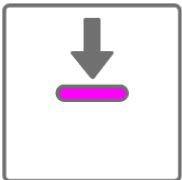

9.3 Recording the Movement of Sound and Effect Parameters in Steps (Motion Recording)

You can record the operation of the Sound Design knobs and touch sliders for single effects in real time (Motion Recording). To execute Motion Recording, hold down the [RECORD] button and turn Sound Design knobs 1–4 or slide the touch sliders.

For details about which sound parameters can be used with Motion Recording, see [“9.1 Adjusting Sound Parameters.”](#)

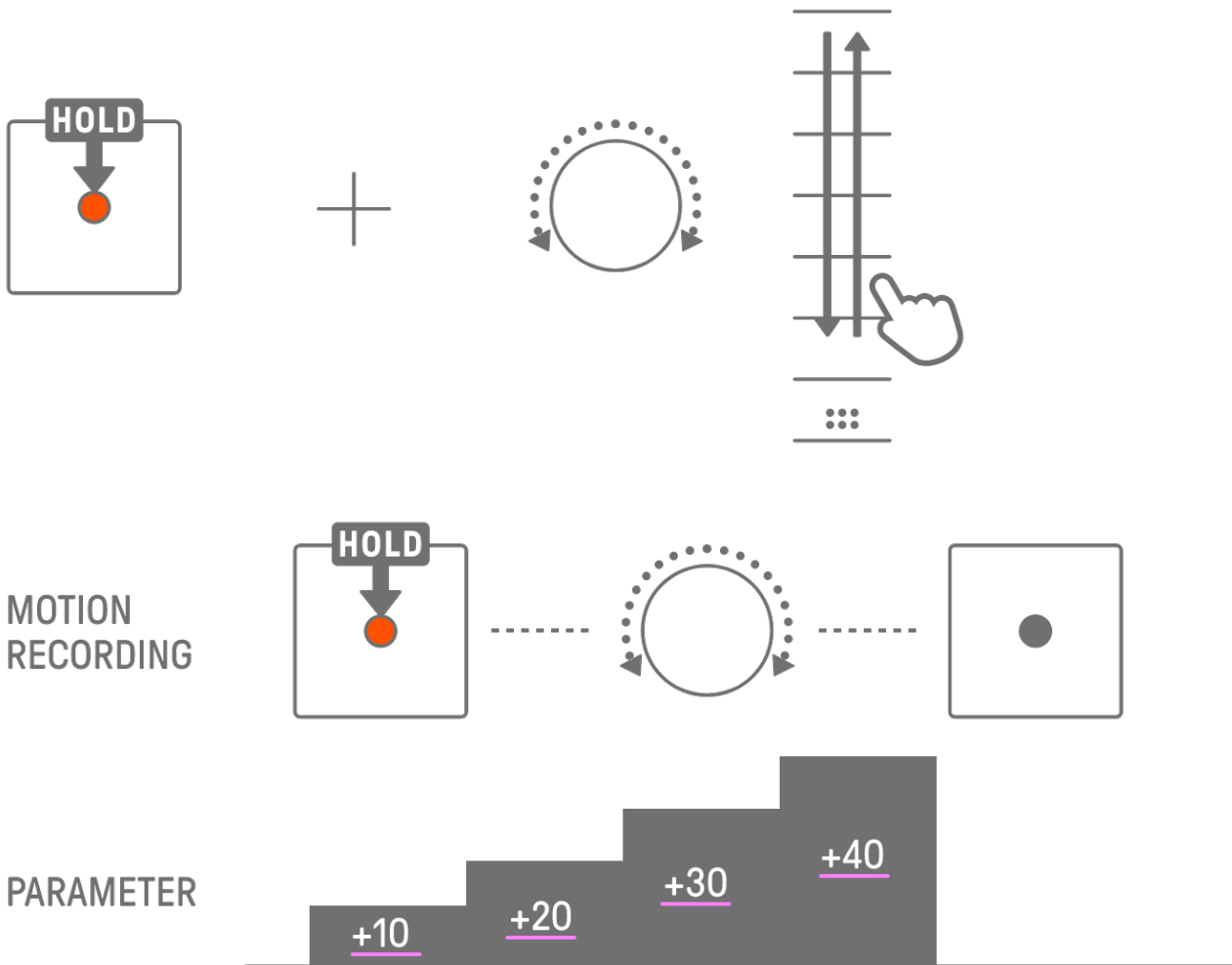

NOTE

- The data recorded with Parameter Lock and Motion Recording is the same. If Motion Recording is executed while Parameter Lock is applied to data, that data will be overwritten.

9.3.1 Deleting a Motion

To delete a Motion, hold down the [DELETE] button and press the Sound Design knob or the [FX] knob.

9.4 Undoing/Redoing Sound and Effect Parameters

The UNDO function cancels the immediately preceding operation and returns SEQTRAK to the state before that operation. The REDO function re-executes the operation canceled by UNDO.

To UNDO/REDO sound and effect parameters, press the [UNDO/REDO] button.

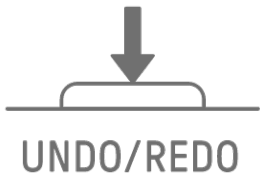

NOTE

- UNDO/REDO cannot be used for sound and effect selections.

9.5 Saving a Sound

You can save a sound after adjusting its parameters. To do this, hold down the [ALL] knob and press Sound Design knob 1. When the sound is saved, the Global Meter flashes in white. The saved sound is inserted after the original sound and can be selected from the sound selection operations. It is also automatically registered as a favorite.

For details about how to select a sound that has been registered as a favorite, see [“5.7.1 Selecting a sound category \(category jump\).”](#)



NOTE

- You can use the SEQTRAK app to add and remove your favorite sounds.
- When a sound is saved from SEQTRAK, “_editNN” (NN: number) is appended to the end of the name of the original sound.

9.6 Deleting a Sound

You can use the SEQTRAK app to delete saved sounds. However, preset sounds cannot be deleted.

9.7 Importing a Sound

The SEQTRAK app provides additional content, including various types of sounds. You can use the content management function in the SEQTRAK app to import this additional content. You can also use the desktop version of the SEQTRAK app to import your own samples into SEQTRAK.

NOTE

- When importing your own samples, use 44.1 kHz / 16-bit or 24-bit WAV data up to 16 seconds in length.

10. Effects

10.1 Configuration of Effects

There are three types of effects: track effects, send effects, and master effects. You can use the touch sliders to adjust the effect parameters. More advanced settings are also available on the SEQTRAK app.

10.1.1 Track effects

Track effects set on a track-by-track basis. Track effect parameters are recorded for each sound. Therefore, they will change when a different sound is selected.

Track effects are connected in the order shown below.

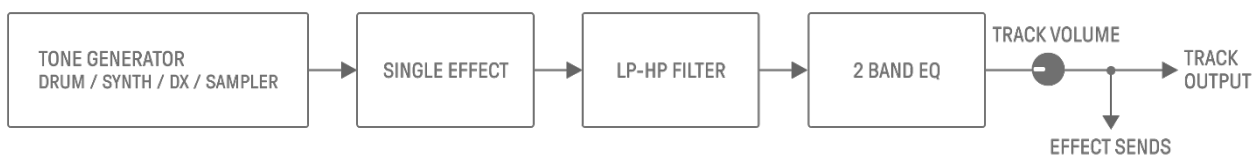

1. SINGLE EFFECT

When the [MASTER/SINGLE] switch is set to SINGLE, you can use the [FX] knob to change the type and the touch sliders to adjust the parameters.

2. LP-HP FILTER

You can use the knobs to control the LPF (low-pass filter) or HPF (high-pass filter). Use Sound Design knob 3 and knob 4 on Sound Design Page 2 to adjust the parameters.

3. 2 BAND EQ

This equalizer is used to correct the sound in two frequency ranges, such as low and high. Use Sound Design knob 3 and knob 4 on Sound Design Page 3 to adjust the parameters.

10.1.2 Send effects

Send effects are shared by all tracks. You can set SEND LEVEL for each track, and RETURN LEVEL for all tracks. Two send effects, DELAY and REVERB, are connected in parallel after the track effects.

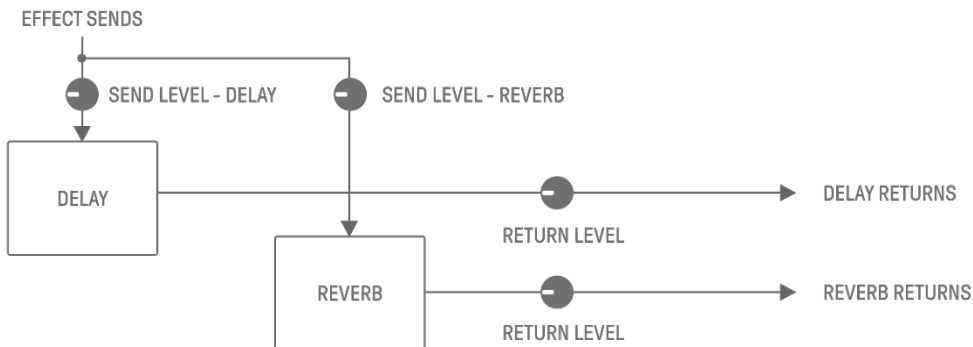

1. DELAY

An effect that delays an audio signal for ambient or rhythmic effects.

In Mixer mode, you can change the type of delay and adjust the parameters.

SEND LEVEL can be adjusted by turning Sound Design knob 2 on Sound Design Page 3, or by pressing Sound Design knob 4 in Mixer mode and turning each Track knob.

2. REVERB

This effect artificially creates complex reverberations to reproduce the ambience of various kinds of spaces in which the sound is being played. It can give natural ambience to the sound and create space and depth.

In Mixer mode, you can change the type of reverb and adjust the parameters.

SEND LEVEL can be adjusted by turning Sound Design knob 1 on Sound Design Page 3, or by pressing Sound Design knob 3 in Mixer mode and turning each Track knob.

10.1.3 Master effects

Master effects are applied to the overall sound at the final stage of audio output. They are connected in the order shown below.

The HIGH PASS and REPEATER effects are primarily for use in performance. When adjusting parameters, the effect turns off when you remove your finger from the slider.

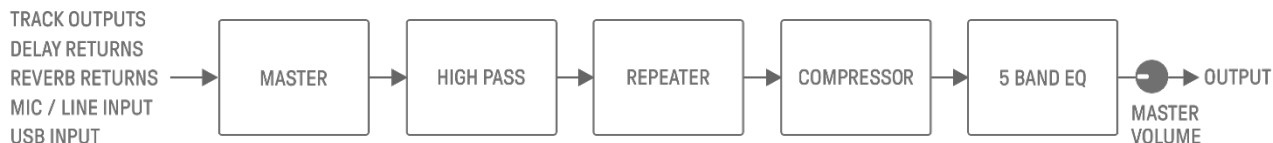

1. MASTER

When the [MASTER/SINGLE] switch is set to MASTER, you can use the [FX] knob to change the type and the touch sliders to adjust the parameters.

2. HIGH PASS

Use the [HIGH PASS] touch slider to adjust the parameters. The default setting is a high-pass filter. You can use the SEQTRAK app to change the effect type.

3. REPEATER

Use the [REPEATER] touch slider to adjust the parameters. The default setting is BEAT REPEAT, which repeats the input sound. You can use the SEQTRAK app to change the effect type.

4. COMPRESSOR

This effect compresses loud voices and lifts quiet voices to create a more dynamically consistent and powerful sound. You can use the SEQTRAK app to change the effect type and adjust the parameters.

5. 5 BAND EQ

This equalizer is used to correct the sound in five frequency ranges, from low to high. You can use the SEQTRAK app to adjust the parameters.

10.2 Changing and Adjusting Effects

10.2.1 Switching the effect to be controlled

You can use the [MASTER/SINGLE] switch to switch between the effects to be controlled. MASTER is for effects applied to all tracks, while SINGLE is for effects applied only to the currently selected track.

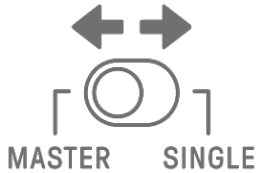

10.2.2 Changing the type of effect

Turn the [FX] knob to change the type of effect on the selected track. If the [MASTER/SINGLE] switch is set to MASTER, you can change the master effect. If it is set to SINGLE, you can change the type of effect on the selected track.

Effects are grouped into eight categories, with eight presets per category. The currently selected effect category is displayed in the index, and the preset number is displayed in the Global Meter. For the lists of presets, see "[18.4 MASTER EFFECT Presets](#)" and "[18.5 SINGLE EFFECT Presets](#)."

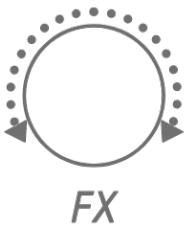

10.2.3 Adjusting effect parameters

Slide the [FX LEVEL]/[HIGH PASS]/[REPEATER] touch sliders to adjust the effect parameters. Each touch slider has different effect parameters for adjusting assigned to each page. Press the FX Page button to switch between effect pages.

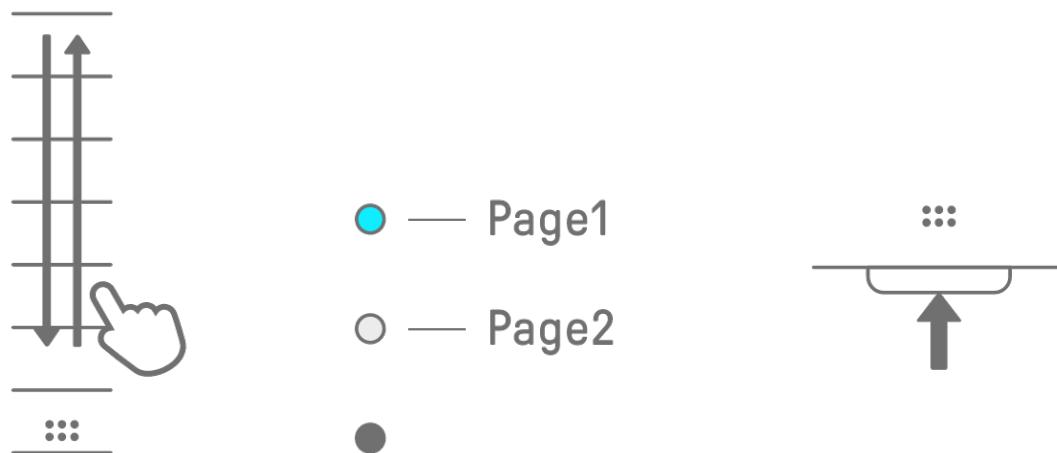

10.2.4 Effect parameters when MASTER is selected

Page	Touch Slider	Parameter
1	FX LEVEL	MASTER EFFECT PARAMETER 1
	HIGH PASS	HIGH PASS FILTER CUTOFF
	REPEATER	BEAT REPEAT LENGTH
2	FX LEVEL	MASTER EFFECT PARAMETER 1
	HIGH PASS	MASTER EFFECT PARAMETER 2
	REPEATER	MASTER EFFECT PARAMETER 3

10.2.5 Effect parameters when SINGLE is selected

Page	Touch Slider	Parameter
1	FX LEVEL	SINGLE EFFECT PARAMETER 1
	HIGH PASS	HIGH PASS FILTER CUTOFF
	REPEATER	BEAT REPEAT LENGTH
2	FX LEVEL	SINGLE EFFECT PARAMETER 1
	HIGH PASS	SINGLE EFFECT PARAMETER 2
	REPEATER	SINGLE EFFECT PARAMETER 3

10.2.6 Example: Parameters when MASTER is selected and preset No. 1 [LPF - NO RESONANCE] of FILTER is selected

Page	Touch Slider	Parameter
1	FX LEVEL	CUTOFF
	HIGH PASS	HIGH PASS FILTER CUTOFF
	REPEATER	BEAT REPEAT LENGTH
2	FX LEVEL	CUTOFF
	HIGH PASS	RESONANCE
	REPEATER	OUTPUT LEVEL

NOTE

- For a list of presets, see "[18.4 MASTER EFFECT Presets](#)" and "[18.5 SINGLE EFFECT Presets](#)."

10.3 Minimizing the Level of Effect Parameters (CLEAR FX)

Press the [CLEAR FX] button to minimize the level of the currently selected effect parameter.



11. Mixer Mode

In this mode, you can use the Track knobs and touch sliders to adjust the sound parameters for all tracks. The sound parameters are indicated by the LED lamps on the Track knobs.

11.1 Switching to Mixer Mode

Hold down the [ALL] knob and press the [VOL+] button to switch to Mixer mode. Use the same procedure to exit Mixer mode.

When you switch to Mixer mode, [MIXER] lights up on the index.



11.2 Adjusting Sound Parameters

Press Sound Design knobs 1–4 to select the sound parameters to be adjusted. The sound parameters correspond to Sound Design knobs 1–4. From the top, they are set to PAN, VOLUME, REVERB SEND, and DELAY SEND. The index of the selected parameter lights up.



PAN



VOLUME



REVERB SEND



DELAY SEND

Turn the Track knobs to adjust the sound parameters for each track. The LED lamps on the Track knobs and the Global Meter indicate the value. You can also press and turn the Track knobs to make greater changes to the sound parameters.

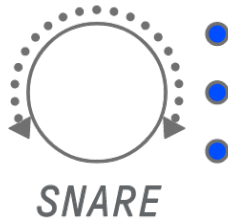
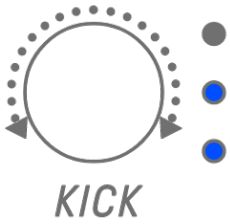

Turning the [ALL] knob adjusts the PAN of the entire project, the VOLUME of the entire project, the RETURN LEVEL of the send effect REVERB, and the RETURN LEVEL of the send effect DELAY for the currently selected parameter.

11.3 Changing and Adjusting Send Effects (REVERB, DELAY)

11.3.1 Changing the type of send effect (REVERB, DELAY SEND)

Eight presets are provided for both REVERB and DELAY. When adjusting REVERB SEND or DELAY SEND, turn the [FX] knob to change the preset. The preset number is displayed on the Global Meter. For a list of presets, see "[18.6 SEND EFFECT Presets.](#)"

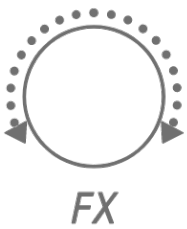

11.3.2 Adjusting send effect (REVERB, DELAY) parameters

Slide the [FX LEVEL]/[HIGH PASS]/[REPEATER] touch sliders to adjust the parameters. Different send effect parameters for adjusting are assigned to each page. To switch pages, press the FX Page button.

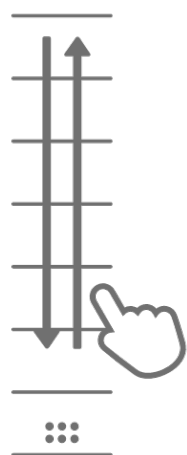

- — Page1
- — Page2
-

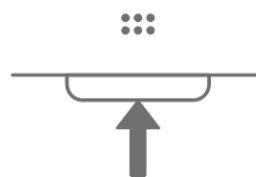

11.3.3 Send effect (REVERB, DELAY) parameters

Page	Touch Slider	Parameter
1	FX LEVEL	SEND EFFECT PARAMETER 1
	HIGH PASS	HIGH PASS FILTER CUTOFF
	REPEATER	BEAT REPEAT LENGTH
2	FX LEVEL	SEND EFFECT PARAMETER 1
	HIGH PASS	SEND EFFECT PARAMETER 2
	REPEATER	SEND EFFECT PARAMETER 3

11.3.4 Example: Send effect parameters for preset No. 1 [HD Room] in REVERB

Page	Touch Slider	Parameter
1	FX LEVEL	REVERB TIME
	HIGH PASS	HIGH PASS FILTER CUTOFF
	REPEATER	BEAT REPEAT LENGTH
2	FX LEVEL	REVERB TIME
	HIGH PASS	ROOM SIZE
	REPEATER	HIGH DAMP FREQUENCY

NOTE

- For a list of presets, see "[18.6 SEND EFFECT Presets.](#)"

12. Mute Mode [OS V1.20]

In Mute mode, you can mute tracks by simply pressing the track knobs without holding down the [MUTE] button.

12.1 Switching to Mute Mode

Hold down the [ALL] knob and press the [MUTE] button to switch to Mute mode. When you switch to Mute mode, the three LEDs on the [ALL] knob light up green. To exit Mute mode, press the [MUTE] button.

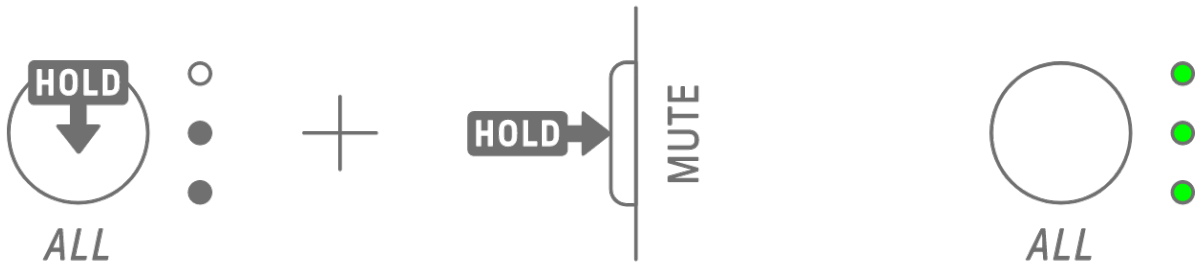

12.2 Muting tracks in Mute Mode

When in Mute mode, you can mute tracks by pressing the track knobs.

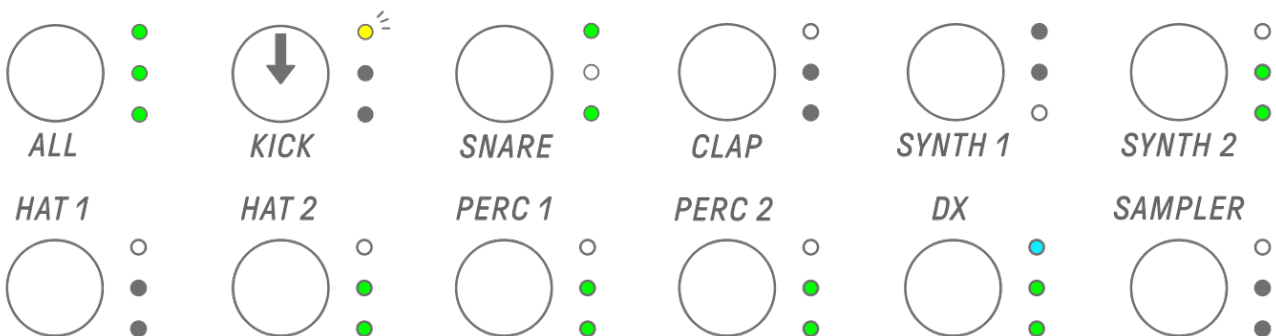

Press the [ALL] knob to unmute all tracks.

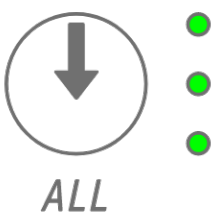

NOTE

- Reserved switching of patterns is not available in Mute mode.
- When the SAMPLER track is selected, pressing the Synth keys will result in a performance operation, not a mute of the sample.

13. Song Mode

This is an auto performance mode in which the patterns in the project are played in a pre-determined order. Each project has one song, and a song consists of up to 16 scenes (phrases that are a combination of patterns from all tracks).

The Song mode includes a Scene mode. In Scene mode, a single scene can be constantly played back in a loop while switching scenes at any given time.

13.1 Switching to Song Mode

Hold down the [ALL] knob and press the [PROJECT ↑] button to switch to Song mode. If a project is being played back, switching to Song mode will stop playback.

When you switch to Song mode, [SONG] lights up on the index. To exit Song mode, first [switch to Scene mode](#) and then use the same procedure.



13.1.1 Switching to Scene mode

When in Song mode, Hold down the [ALL] knob and press the [PROJECT ↑] button to switch to Scene mode. Use the same procedure to exit Scene mode.



NOTE

- Exiting song or Scene mode does not stop playback. Pattern combinations and mute/solo status are maintained when you exit Song mode and Scene mode.

13.2 Playing/Stopping a Scene

In Song mode, press the [⏮/PLAY] button to play the scenes in order from the beginning of the currently selected scene. While a scene is playing back, you can press the [⏮/PLAY] button to stop playback.

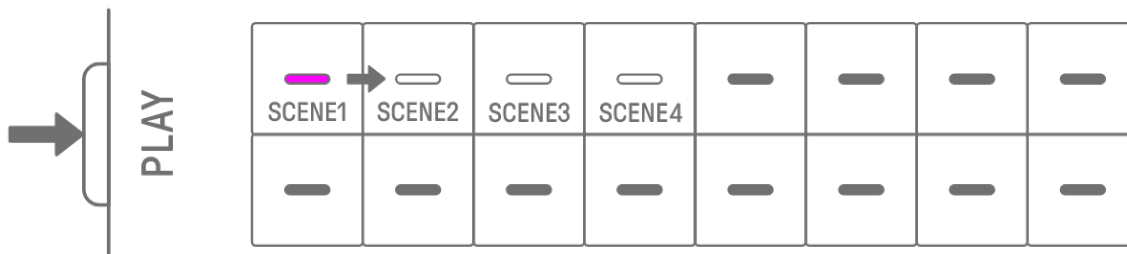

In Scene mode, press the [⏮/PLAY] button to repeat the selected scene (loop playback). While a scene is playing back, you can press the [⏮/PLAY] button to stop playback.



13.2.1 Changing the scene to be played back

To change the scene to be played back, press the Drum key for a scene.

In Song mode, if you make this change while a scene is playing, the selected scene will start when the currently playing scene plays to the end. In Scene mode, the selected scene will start at the [Launch Quantize](#) timing.



13.2.2 Repeating a scene (Loop Playback)

In Song mode, double-tap the Drum key while a scene is playing to loop that scene. During loop playback, the corresponding Drum key lights up alternately in purple and cyan blue. If you double-tap another scene while a scene is playing, the currently playing scene will play to the end, and then the other scene you selected will loop.

To cancel loop playback, press the Drum key or select another scene.

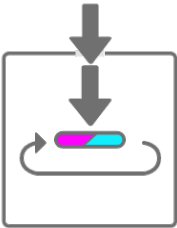

13.2.3 Repeating an entire song (Loop Playback)

You can use the SEQTRAK app to loop an entire song. The default setting is OFF, which means that song playback stops when the last scene finishes playing.

13.3 Adding Scenes

To add a scene, press a Drum key that is not lit (an empty scene). You can add up to 16 scenes. The selected scene will be copied to the new scene.

Song mode

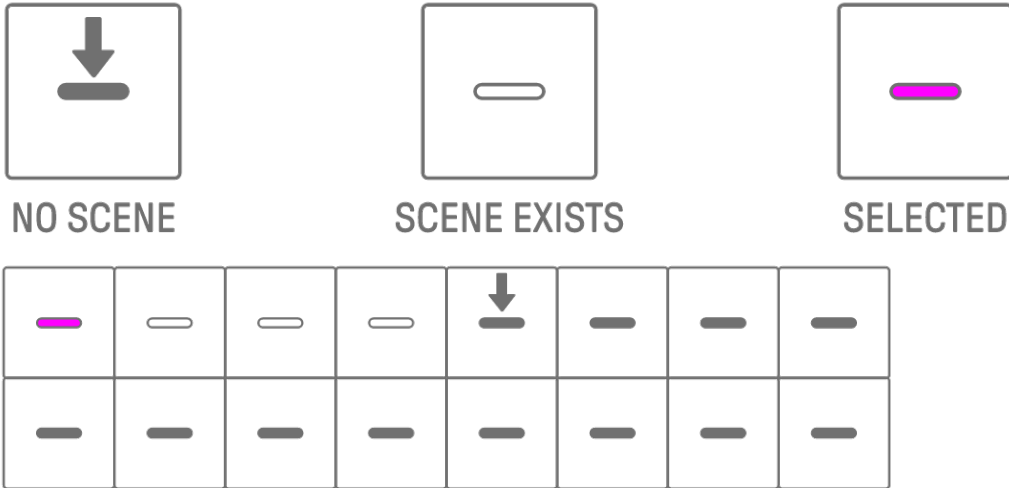

Scene mode

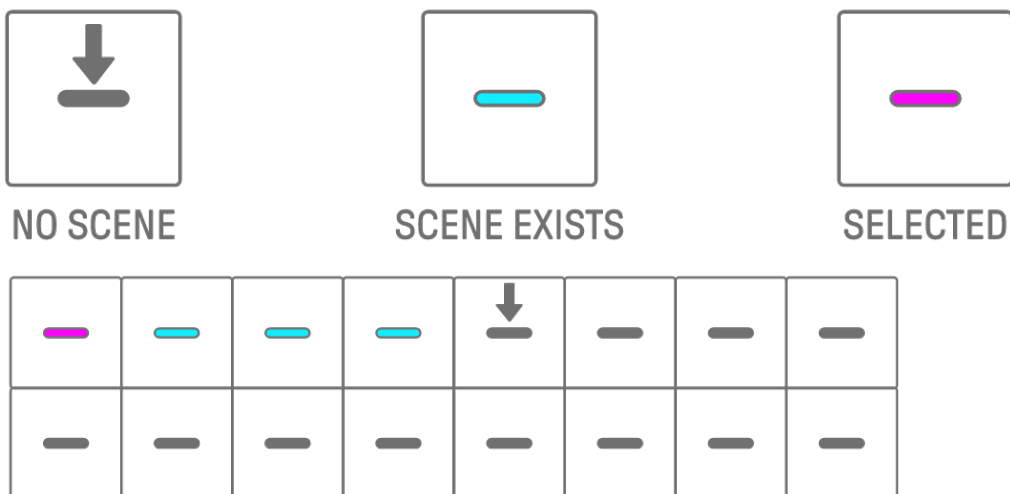

13.4 Deleting a Scene

To delete a scene, hold down the [DELETE] button and press the Drum key that is lit in red. Scenes behind the deleted scene will be moved forward in order.



NOTE

- The scene being played back will not be deleted.

13.5 Editing a Scene

13.5.1 Changing the combination of patterns in a scene

Turn the Track knobs to change the combination of patterns for the selected scene. Turn the [ALL] knob to change all 11 tracks simultaneously.

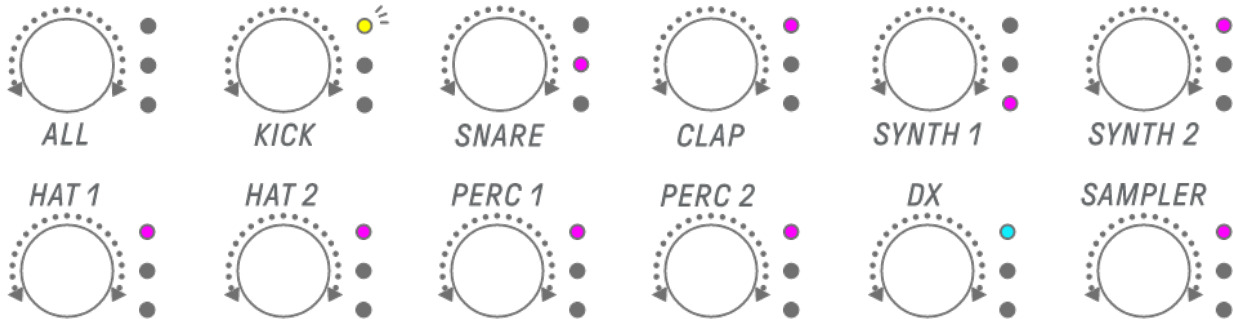

NOTE

- You can also enable Mute and Solo.

13.5.2 Changing the length of a scene

In Song mode, hold down the [PAGE] button and turn the [ALL] knob to change the length of the selected scene. Press and turn the [ALL] knob to change the scene length in increments of one measure (16 steps). The number of measures is displayed on the Global Meter, and the number of steps is displayed on the Drum keys.

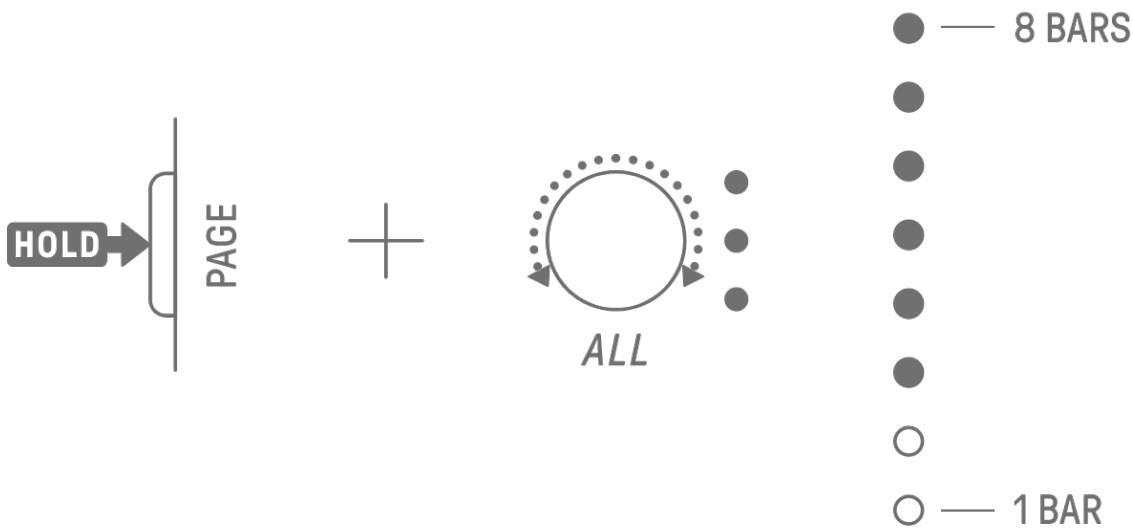

1	2	3	4	5	6	7	8
9	10	11	12	13	14	15	16

NOTE

- If you turn the [ALL] knob fully left, all Drum keys light in cyan blue and the scene length is set to AUTO. This will automatically set the length of the scene to the length of the longest pattern in the scene.

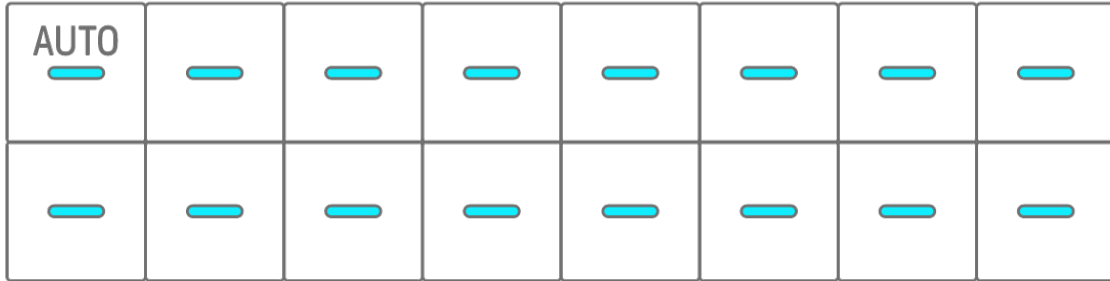

14. SEQTRAK App

The four main functions of the SEQTRAK app are described below. For details about how to obtain the SEQTRAK app, see “[1.4.1 Obtaining the SEQTRAK app.](#)” For details about how to connect the SEQTRAK app to SEQTRAK, see “[15.1 Connecting to the SEQTRAK App.](#)”

*The screens from the SEQTRAK app shown in this section are for the iOS version. The design of the app is subject to change without notice.

14.1 GUI Functions [GUI EDITOR]

You can use this function to make advanced settings on the app screen, such as for sound design and effect parameters. It provides access to more parameters than are available on SEQTRAK. For example, you can adjust the LFOs on each track, assign alternate sound groups that stop certain sounds between two Drum tracks (such as open and closed hi-hats), and all of the parameters for the FM engine on the DX track.

The app screen automatically changes to match the operation of SEQTRAK.

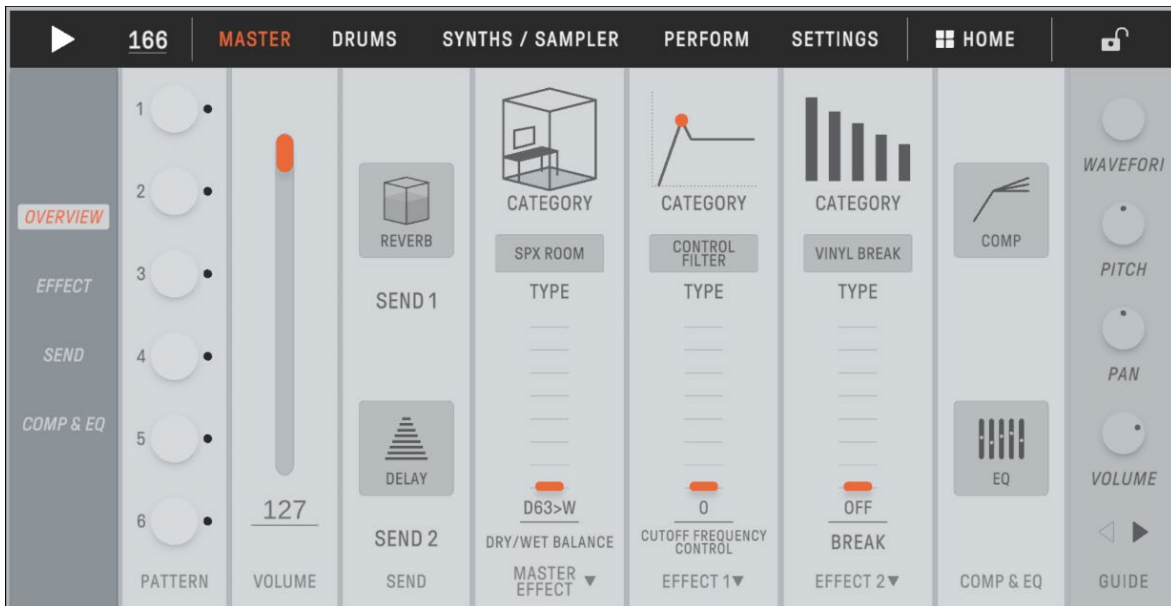

NOTE

- You can also configure advanced settings for the parameters in Mixer mode and Song mode.

14.2 Content Management Function [PROJECT/SOUND MANAGER]

There are three main functions.

- Manage projects (back up/restore projects)
- Manage sounds (add and delete samples, download additional content, etc.)
- Create new projects with sounds specified for each track

Content management functions are available via a USB or Wi-Fi connection.

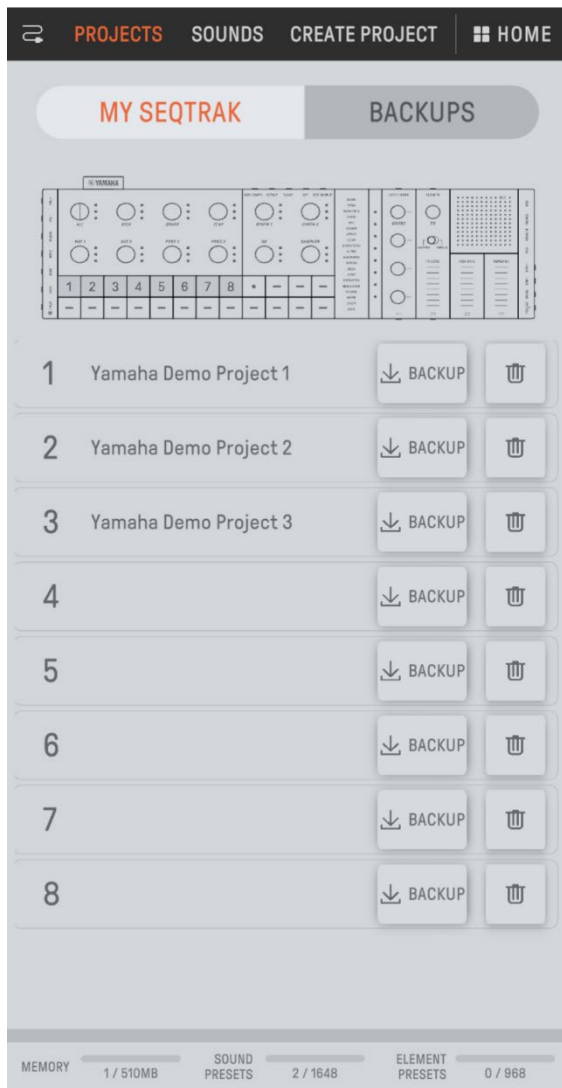

NOTE

- When you select the content management function, the LED lamp for the [ALL] knob on SEQTRAK lights up red and SEQTRAK enters content mode. If the connection to the SEQTRAK app is lost, you can press the [ALL] knob to exit content mode.
- In content mode, SEQTRAK can perform only two operations: turning off the power and exiting content mode.

14.3 Visualizer Function [VISUALIZER]

Use this function to create 3D objects and visual effects that respond in real time to your performance on SEQTRAK. You can use it for live performances, or to record and publish the visuals you create on the Internet or other media. There is also an AR mode that uses your smart device's camera to overlay 3D objects and visual effects on real images.

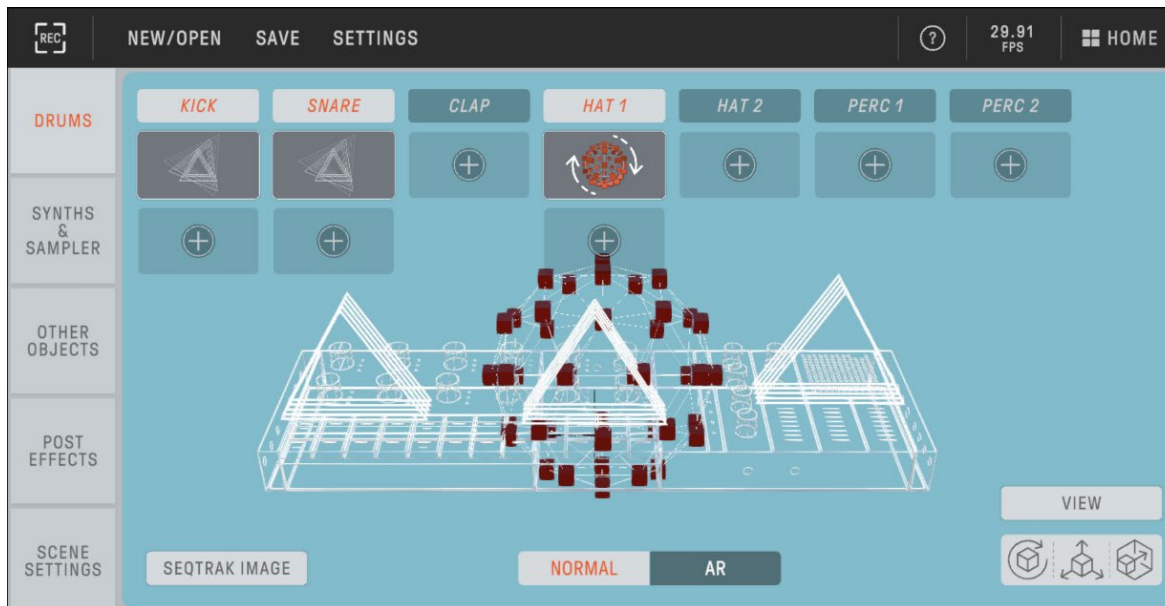

14.4 Dynamic Tutorial Function [DYNAMIC TUTORIAL]

The operations that are being executed on SEQTRAK are displayed on the app's screen. You can use this function to get a better understanding of SEQTRAK as you use it. Information related to the operation of SEQTRAK can be found under [RELATED INFORMATION].

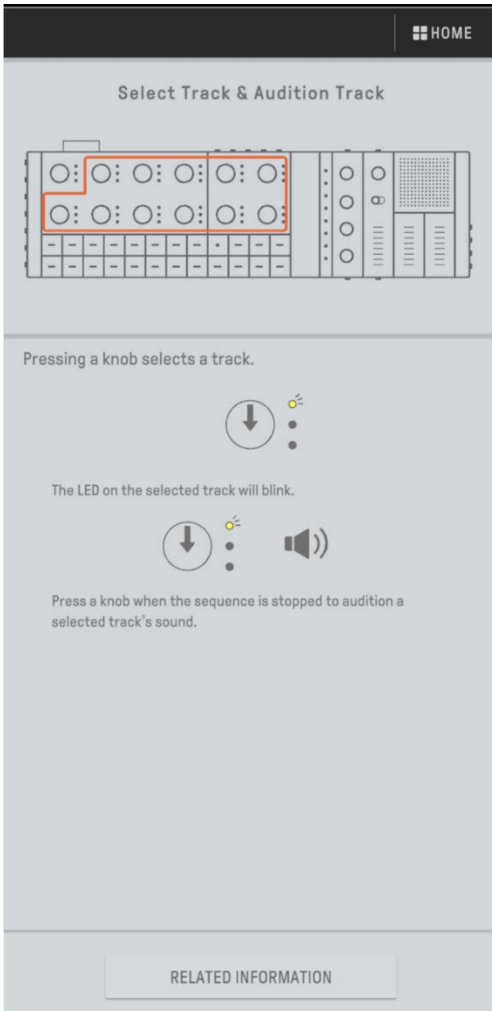

15. Connections

15.1 Connecting to the SEQTRAK App

There are two ways to connect to the SEQTRAK app: wired and wireless (Bluetooth and Wi-Fi).

*The availability of wireless functionality in SEQTRAK varies from country to country.

*The SEQTRAK app for Windows does not support wireless functionality.

15.1.1 Wired connection

Use the included USB-C to USB-C cable to connect SEQTRAK to a smart device or computer.

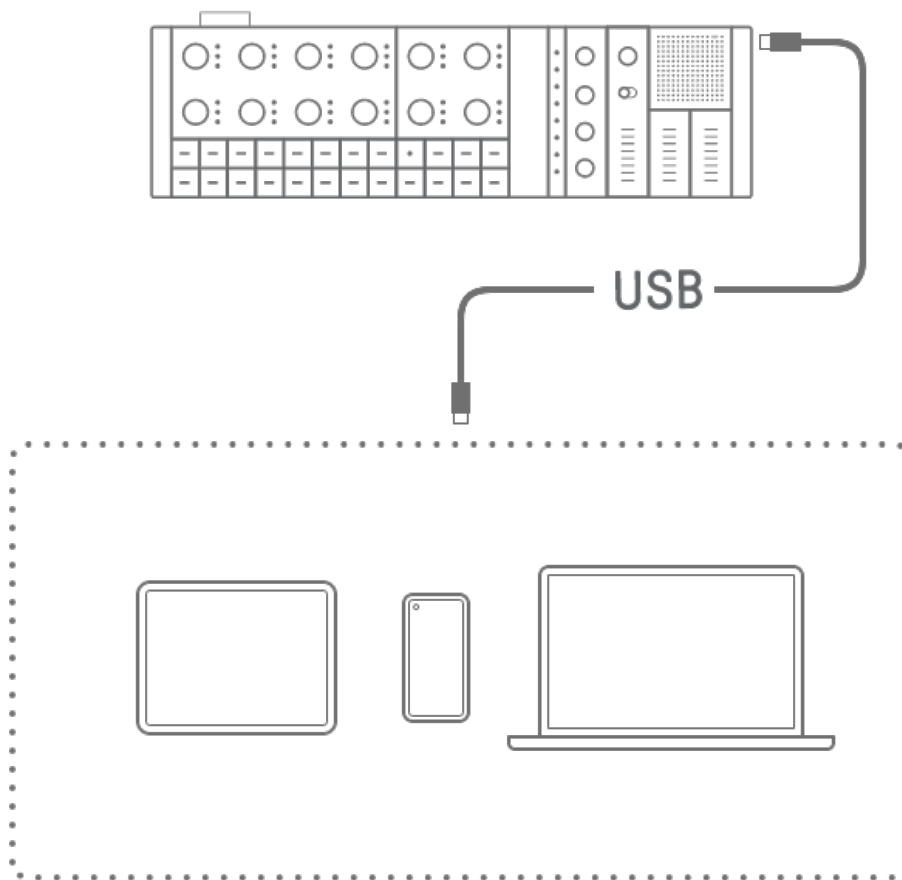

NOTE

- The Apple Lightning to USB 3 Camera Adapter (sold separately) and USB-A to USB-C cable are required to connect to an iPhone or iPad with a Lightning connector.

15.1.2 Wireless connection (Bluetooth)

Open [DEVICE CONNECTION] in the SEQTRAK app. Hold down the [ALL] knob on SEQTRAK and press the [SWING] button. The Global Meter will light in white for 2 seconds and then SEQTRAK will wait 30 seconds for a Bluetooth connection. From [DEVICE CONNECTION] in the SEQTRAK app, select [SEQTRAK_6 alphanumeric characters specific to the device] to complete the connection.



NOTE

- Hold down the [ALL] knob and press the [SWING] button to check the connection status with the device. If there is a Bluetooth connection with the device, the Global Meter will light in cyan blue for 2 seconds.

15.1.3 Wireless connection (Wi-Fi)

After making a Bluetooth connection, the SEQTRAK app has some functions that require a Wi-Fi connection (such as the [PROJECT/SOUND MANAGER] content management function). When a Wi-Fi connection is required, the SEQTRAK app will display a connection setup screen.

There are two modes: direct connection between SEQTRAK and the device, and connection between SEQTRAK and the device via an external access point. Select the appropriate mode according to your network environment and then follow the onscreen instructions in the SEQTRAK app to make a Wi-Fi connection.

NOTE

- SEQTRAK supports the 2.4 GHz band.

15.2 Connecting to MIDI Devices

MIDI signals can be exchanged by connecting SEQTRAK to a MIDI device.

15.2.1 Using a USB-C to USB-C cable

Use the included USB-C to USB-C cable to connect SEQTRAK to a MIDI device. If the MIDI device requires power, SEQTRAK can supply up to 500 mA of current. However, current cannot be supplied to the MIDI device if the battery power of SEQTRAK is too low (Global Meter at 2 LEDs or less).

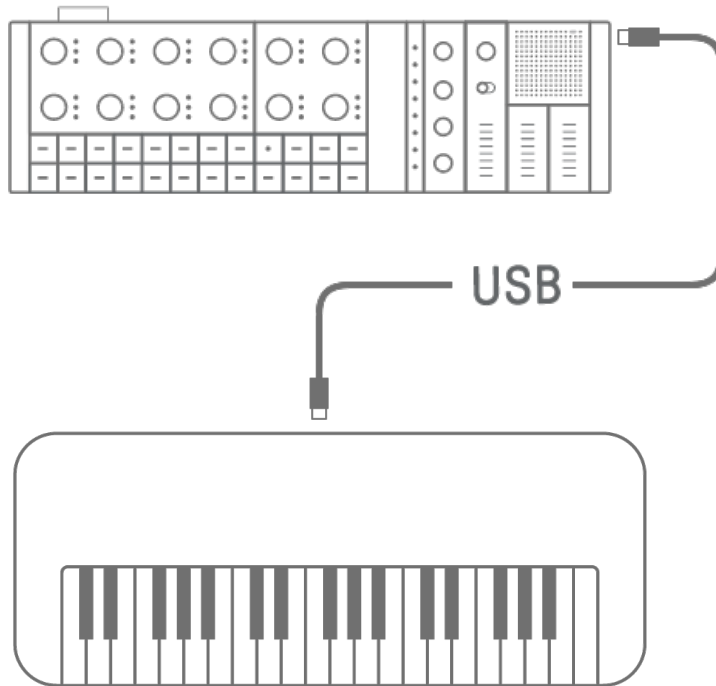

NOTE

- A commercially available USB hub and USB charging adapter are required to charge SEQTRAK while connected to a MIDI device. See the downloads page on the following website for a list of supported devices.
- SEQTRAK can operate on many class-compliant MIDI devices. However, some MIDI devices may not work depending on the compatibility of the connection. See the downloads page of the following website for a list of Yamaha MIDI devices that have been tested and confirmed to work with SEQTRAK.

Website: <https://www.yamaha.com/2/seqtrak/>

- If the shape of the terminal is different from that of the MIDI device to which you are connecting, use an appropriate commercially available conversion cable.

15.2.2 Using a MIDI conversion cable

Use the included MIDI conversion cable to connect SEQTRAK to a MIDI device. The MIDI IN terminal is for receiving MIDI data, and the MIDI OUT terminal is for sending MIDI data.

NOTICE

- When connecting the included MIDI conversion cable, turn off the power to SEQTRAK and MIDI device. Connecting the cable with the power on could affect the tempo and voices.

15.3 Connecting to a Computer

You can expand the scope of your music production by connecting SEQTRAK to a computer (Windows or Mac) and using music production tools such as DAW software.

15.3.1 Connecting to a computer (Windows)

1. Install the Yamaha Steinberg USB Driver on your computer. You can obtain the Yamaha Steinberg USB Driver from the downloads page on the following website.

<https://www.yamaha.com/2/seqtrak/>

2. Use the included USB-C to USB-C cable to connect the computer to SEQTRAK.

15.3.2 Connecting to a computer (Mac)

Use the included USB-C to USB-C cable to connect the computer to SEQTRAK.

NOTE

- If the computer you are connecting to only has a USB Type-A terminal, prepare a USB-A to USB-C cable. However, please note the following precautions.
- Stable connection to all computers is not guaranteed.
- The current supplied by a computer is limited to 500 mA. Therefore, under certain usage conditions, the internal battery could be drained.
- If you want to use SEQTRAK while charging the built-in battery, use the included USB-C to USB-C cable to connect the unit to a computer with a USB Type-C port.

16. Settings

16.1 Restoring the Factory Defaults (Factory Reset)

To restore SEQTRAK settings and data to the factory defaults (initialization), simultaneously Hold down the [SAMPLER] knob and the [UNDO/REDO] button and turn on SEQTRAK.

SAMPLER

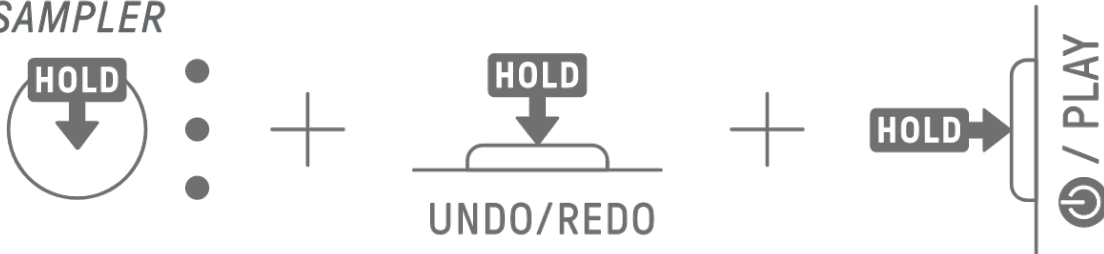

During initialization, the Global Meter light in red. After initialization is complete, the unit will start up.

16.2 Changing the Sensitivity Settings of the Track Knobs

You can use the SEQTRAK app to change the sensitivity settings of the Track knobs.

16.3 Configuring MIDI Settings

16.3.1 Setting the MIDI clock

The MIDI clock controls the timing information of the MIDI system. This makes it possible to perform along with the same tempo and timing when connected to different MIDI devices or software. You can use the SEQTRAK app to set the MIDI clock.

16.3.2 Setting MIDI output filters

The output of a variety of MIDI data from SEQTRAK can be selectively turned on and off. You can use the SEQTRAK app to set MIDI output filters.

16.3.3 Setting MIDI Thru [OS V1.20]

MIDI data input from an external MIDI device or software can be output to a specified interface (MIDI, USB, Bluetooth).

The default settings for each interface are as follows.

MIDI: OFF USB: ON* Bluetooth: ON*

* Channel Messages and System Realtime Messages

You can use the SEQTRAK app to set MIDI Thru.

NOTE

- Some MIDI data, such as arpeggiator trigger notes and muted track notes, are not output via MIDI Thru.
- When USB is selected as the MIDI Thru output destination, MIDI Thru is available only when connected to a computer or the SEQTRAK app.

17. Firmware Updates

The firmware can be updated to improve the functionality and operability of SEQTRAK. We recommend that you update your firmware to the latest version in order to enjoy the full functionality of SEQTRAK. You can choose from the following three methods of updating the firmware. Note that the firmware should be updated only after SEQTRAK has been fully charged. You can check the installed firmware version from the SEQTRAK app.

17.1 Using a USB Flash Drive

The firmware can be updated with an update file stored on a USB flash drive. See the downloads page on the following website for a list of supported USB flash drives.

<https://www.yamaha.com/2/seqtrak/>

To update the firmware with a USB flash drive, the USB flash drive must be formatted. If the USB flash drive to be used for a firmware update contains data, transfer that data to another USB flash drive or computer, and then format the flash drive.

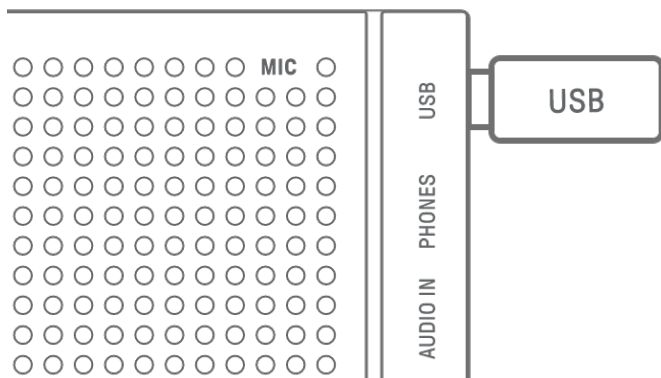

NOTICE

- The format operation erases any existing files. Make sure that the USB flash drive you are formatting does not contain any important files.
- Do not remove or insert a USB flash drive while it is being formatted or during a firmware update. Doing so could cause the unit to stop functioning or damage the USB flash drive and/or files.
- Wait a few seconds between inserting and removing a USB flash drive.
- Do not use USB extension cables to connect a USB flash drive; connect it directly.

17.1.1 Formatting a USB flash drive

Hold down the [DX] knob and the [UNDO/REDO] button and turn on SEQTRAK to format the connected USB flash drive. When formatting is complete, all index light in white. When formatting is complete, press the [⏻/PLAY] button to turn off the power.

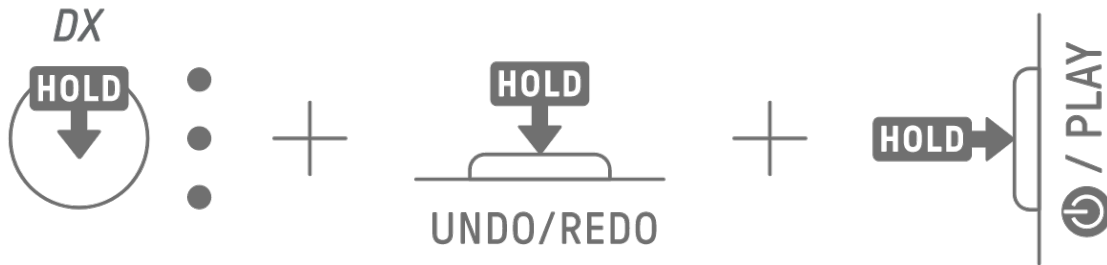

17.1.2 Updating the firmware

1. Use a computer or other device to download the latest SEQTRAK firmware from the downloads page on the following website.

<https://www.yamaha.com/2/seqtrak/>

2. Save the update file (8Z330S_.PGM) in the downloaded .zip file to the USB flash drive.

3. Turn off the power to SEQTRAK.

4. Connect the USB flash drive that contains the update file to SEQTRAK.

5. Hold down the [KICK] knob and the [BAR LENGTH] button and turn on SEQTRAK.

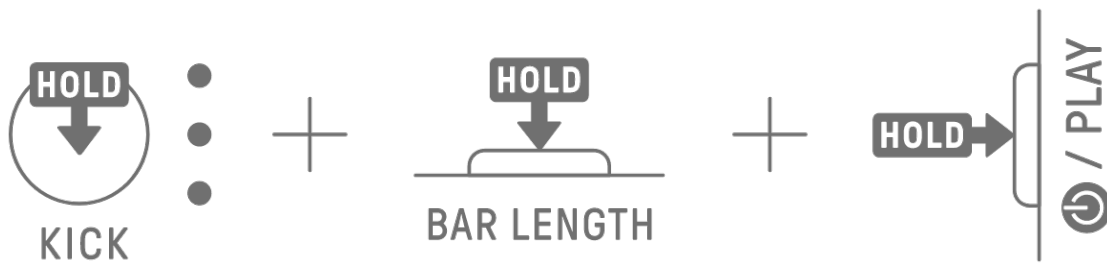

The LED lamps on SEQTRAK will flash as the update progresses.

When the update has successfully completed, all index will light up for a period of time, after which SEQTRAK will automatically restart. After restarting, SEQTRAK can be used as usual.

If the update fails, the Global Meter flashes in red. In this case, try updating again.

17.2 Using the SEQTRAK App (for a Wired Connection)

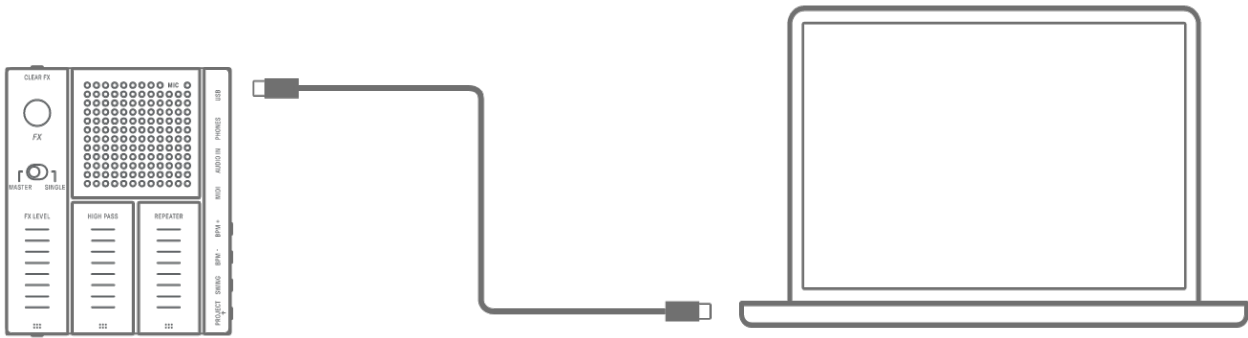

Update procedure

1. Use the included USB-C to USB-C cable to connect the smart device or computer to SEQTRAK.
2. Open the SEQTRAK app on your smart device or computer.
3. Follow the onscreen instructions in the SEQTRAK app to perform the update. If the update fails, try updating again.

17.3 Using the SEQTRAK App (for a Wireless Connection)

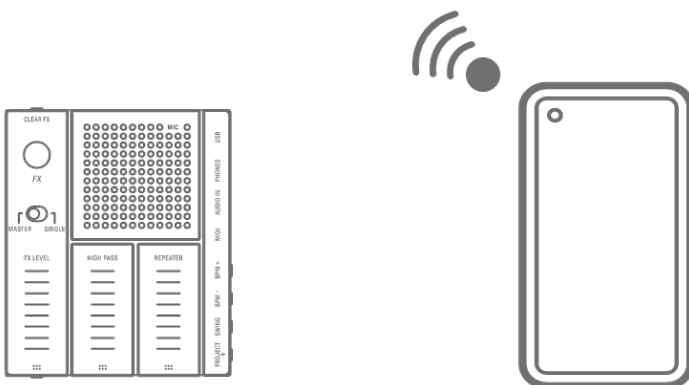

Update procedure

1. Open the SEQTRAK app on your smart device.
2. Connect the smart device and SEQTRAK via Bluetooth. For details about how to make a wireless connection, see [“15.1.2 Wireless connection \(Bluetooth\)”](#).
3. Follow the onscreen instructions in the SEQTRAK app to perform the update. If the update fails, try updating again.

18. Documentation

18.1 Product Specifications

Tone Generator		
Tone Generator	AWM2, FM: 4 operators	
Maximum Polyphony	AWM2: 128, FM: 8	
Wave	Preset: 800 MB (when converted to 16-bit linear format), User: 500 MB	
Effects	Reverb × 12 types, Delay × 9 types, Master Effect × 85 types, Single Effect × 85 types Master EQ 5 bands, LP-HP filters for each track	
Tracks		
Track Types	DRUM, SYNTH, DX, SAMPLER	
Number of Tracks	11	
Sounds		
Number of Sounds	Preset sounds: 2032; Preset Sampler sounds: 392 * Can be added from the SEQTRAK app	
Project		
Number of Projects	8 * Can be saved to the SEQTRAK app	
Connectivity		
Connectors	USB Type-C (power, MIDI to host, MIDI to device, audio) PHONES (stereo mini jack) AUDIO IN (stereo mini jack) MIDI IN/OUT * Only included cable can be used.	
Functions		
USB Audio Interface	Sampling Frequency	44.1 kHz (quantization bit depth: 24-bit)
	Input/Output Channels	Input: 2 channels (stereo 1 channel) Output: 2 channels (stereo 1 channel)
Bluetooth	MIDI transmission/reception (wireless capability varies by country)	
Wi-Fi	Data transmission/reception with dedicated app (wireless capability varies by country), support the 2.4 GHz band The highest SAR value: 1.11 W/kg	
Sound System		
Speakers	2.3 cm, 1 W	
Microphone	MEMS microphone	
Power Supply		
Power Source	Rechargeable lithium-ion battery (2100 mAh, 7.6 Wh) USB Power Delivery (PD) (Output voltage: 4.8 V to 5.2 V; Output current: 1.5 A or greater)	

Power Consumption	6 W
Battery life for continuous use	3–4 hours
Battery charge time	3–5 hours
Size/Weight	
Dimensions/Weight	W343 × D97 × H38 mm, 0.5 kg
Other	
Included Accessories	USB-C to USB-C cable, dedicated MIDI Converter Cable, Quick Operation Guide, Safety Guide
Dedicated Software	SEQTRAK App
Sequencer Block	Maximum Steps
	128

The contents of this manual apply to the latest specifications as of the publishing date. To obtain the latest manual, access the Yamaha website then download the manual file. Since specifications, equipment or separately sold accessories may not be the same in every locale, please check with your Yamaha dealer.

NOTICE

- On Android devices, the USB audio interface function might not work properly when using an app other than the SEQTRAK app.
- Bluetooth and Wi-Fi are not supported for Windows.

18.2 MIDI Channels

CHANNEL	TRACK NAME
1	KICK
2	SNARE
3	CLAP
4	HAT 1
5	HAT 2
6	PERC 1
7	PERC 2
8	SYNTH 1
9	SYNTH 2
10	DX
11	SAMPLER

18.3 MIDI Control Change Parameters

18.3.1 Sound Design parameters

PARAMETER	CC	CHANNEL	RANGE	AVAILABLE ON
TRACK VOLUME	7	1-11	0-127	DRUM, SYNTH, DX, SAMPLER
TRACK PAN	10	1-11	1-127	DRUM, SYNTH, DX, SAMPLER
DRUM PITCH	25	1-7	40-88	DRUM
MONO/POLY/CHORD	26	8-10	0=MONO 1=POLY 2=CHORD	SYNTH, DX
ATTACK TIME	73	1-11	0-127	DRUM, SYNTH, DX, SAMPLER
DECAY/RELEASE TIME	75	1-11	0-127	DRUM, SYNTH, DX, SAMPLER
FILTER CUTOFF	74	1-11	0-127	DRUM, SYNTH, DX, SAMPLER
FILTER RESONANCE	71	1-11	0-127	DRUM, SYNTH, DX, SAMPLER
REVERB SEND	91	1-11	0-127	DRUM, SYNTH, DX, SAMPLER
DELAY SEND	94	1-11	0-127	DRUM, SYNTH, DX, SAMPLER
EQ - HIGH GAIN	20	1-11	40-88	DRUM, SYNTH, DX, SAMPLER
EQ - LOW GAIN	21	1-11	40-88	DRUM, SYNTH, DX, SAMPLER
PORTAMENTO TIME	5	8-10	0-127 (0=OFF)	SYNTH, DX (must be mono)
PORTAMENTO SWITCH	65	8-10	0=OFF 1=ON	SYNTH, DX
ARP TYPE	27	8-10	0-16 (0=OFF)	SYNTH, DX
ARP GATE	28	8-10	0-127	SYNTH, DX
ARP SPEED	29	8-10	0-9	SYNTH, DX
FM ALGORITHM	116	10	0-127	DX
FM MODULATION AMOUNT	117	10	0-127	DX
FM MODULATOR FREQUENCY	118	10	0-127	DX
FM MODULATOR FEEDBACK	119	10	0-127	DX

18.3.2 Effect parameters

PARAMETER	CC	CHANNEL	RANGE	AVAILABLE ON
MASTER EFFECT 1 -ASSIGNED PARAMETER 1	102	1	0-127	
MASTER EFFECT 1 -ASSIGNED PARAMETER 2	103	1	0-127	
MASTER EFFECT 1 -ASSIGNED PARAMETER 3	104	1	0-127	
MASTER EFFECT 2 -ASSIGNED PARAMETER	105	1	0-127	
MASTER EFFECT 3 -ASSIGNED PARAMETER	106	1	0-127	
SINGLE EFFECT -ASSIGNED PARAMETER 1	107	1-11	0-127	DRUM, SYNTH, DX, SAMPLER
SINGLE EFFECT -ASSIGNED PARAMETER 2	108	1-11	0-127	DRUM, SYNTH, DX, SAMPLER
SINGLE EFFECT -ASSIGNED PARAMETER 3	109	1-11	0-127	DRUM, SYNTH, DX, SAMPLER
SEND REVERB -ASSIGNED PARAMETER 1	110	1	0-127	
SEND REVERB -ASSIGNED PARAMETER 2	111	1	0-127	
SEND REVERB -ASSIGNED PARAMETER 3	112	1	0-127	
SEND DELAY -ASSIGNED PARAMETER 1	113	1	0-127	
SEND DELAY -ASSIGNED PARAMETER 2	114	1	0-127	
SEND DELAY -ASSIGNED PARAMETER 3	115	1	0-127	

18.3.3 Mute/Solo

PARAMETER	CC	CHANNEL	RANGE	AVAILABLE ON
MUTE	23	1-11	0-63=OFF 64-127=ON	DRUM, SYNTH, DX, SAMPLER
SOLO	24	1-11	0-11 (0=OFF 1=TRACK1 2=TRACK2... 11=TRACK11)	DRUM, SYNTH, DX, SAMPLER

NOTE

- MUTE and SOLO are receive only.

18.3.4 Other

PARAMETER	CC	CHANNEL	RANGE	AVAILABLE ON
DAMPER PEDAL	64	8-11	0-127	SYNTH, DX, SAMPLER
SOSTENUTO	66	8,9,11	0-63=OFF 64-127=ON	SYNTH, SAMPLER
EXPRESSION CONTROL	11	1-11	0-127	DRUM, SYNTH, DX, SAMPLER

NOTE

- These are for receive only.

18.4 MASTER EFFECT Presets

18.4.1 FILTER

No.	NAME	TYPE	PARAMETER 1	PARAMETER 2	PARAMETER 3
1	LPF - NO RESONANCE	CONTROL FILTER	CUTOFF	RESONANCE	OUTPUT LEVEL
2	LPF - LOW RESONANCE				
3	LPF - MID RESONANCE				
4	LPF - HIGH RESONANCE				
5	HPF - NO RESONANCE				
6	HPF - LOW RESONANCE				
7	HPF - MID RESONANCE				
8	HPF - HIGH RESONANCE				

18.4.2 REVERB

No.	NAME	TYPE	PARAMETER 1	PARAMETER 2	PARAMETER 3
1	SMALL ROOM 1	SPX ROOM	DRY/WET	REVERB TIME	LPF CUTOFF - FREQUENCY
2	SMALL ROOM 2	SPX ROOM			
3	MID ROOM	SPX ROOM			
4	SMALL HALL	SPX HALL			
5	MID HALL	SPX HALL			
6	STAGE	SPX STAGE			
7	GATED REVERB	GATED REVERB		ROOM SIZE	
8	REVERSE REVERB	REVERSE REVERB			

18.4.3 DELAY

No.	NAME	TYPE	PARAMETER 1	PARAMETER 2	PARAMETER 3
1	TEMPO DELAY 4TH	TEMPO DELAY - STEREO	DRY/WET	DELAY TIME	FEEDBACK
2	PING PONG DELAY 4TH	TEMPO CROSS - DELAY		DELAY TIME L>R & DELAY TIME R>L	
3	TEMPO DELAY 8TH DOT	TEMPO DELAY - STEREO		DELAY TIME	
4	TEMPO DELAY 8TH	TEMPO DELAY - STEREO		DELAY TIME	
5	PING PONG DELAY 8TH	TEMPO CROSS - DELAY		DELAY TIME L>R & DELAY TIME R>L	
6	TEMPO DELAY 16TH	TEMPO DELAY - STEREO		DELAY TIME	
7	ANALOG DELAY - MODERN	ANALOG DELAY - MODERN		DELAY TIME	
8	ANALOG DELAY RETRO	ANALOG DELAY - RETRO		DELAY TIME	

18.4.4 COMPRESSOR

No.	NAME	TYPE	PARAMETER 1	PARAMETER 2	PARAMETER 3
1	COMP - SETTING 1	UNI COMP DOWN	RATIO	THRESHOLD	MAKE UP GAIN
2	COMP - SETTING 2				
3	COMP - SETTING 3				
4	COMP - SETTING 4				
5	COMP - SETTING 5				
6	COMP - SETTING 6				
7	COMP - SETTING 7				
8	COMP - SETTING 8				

18.4.5 DISTORTION

No.	NAME	TYPE	PARAMETER 1	PARAMETER 2	PARAMETER 3
1	WAVE FOLDER - SATURATION	WAVE FOLDER	DRY/WET	FOLD	INPUT LEVEL
2	COMP DISTORTION	COMP DISTORTION	DRY/WET	OVERDRIVE	LPF CUTOFF - FREQUENCY
3	WAVE FOLDER	WAVE FOLDER	DRY/WET	FOLD	INPUT LEVEL
4	AMP SIMULATOR 2 - SETTING 1	AMP SIMULATOR 2	DRY/WET	OVERDRIVE	LPF CUTOFF - FREQUENCY
5	AMP SIMULATOR 1	AMP SIMULATOR 1	DRY/WET	OVERDRIVE	PRESENCE
6	AMP SIMULATOR 2 - SETTING 2	AMP SIMULATOR 2	DRY/WET	OVERDRIVE	LPF CUTOFF - FREQUENCY
7	BIT CRUSHER	BIT CRUSHER	SAMPLE RATE	BIT	DRY/WET
8	DIGITAL TURNTABLE	DIGITAL - TURNTABLE	NOISE LEVEL	CLICK LEVEL	DRY SEND TO - NOISE

18.4.6 MODULATION

No.	NAME	TYPE	PARAMETER 1	PARAMETER 2	PARAMETER 3
1	SPX CHORUS	SPX CHORUS	DRY/WET	LFO SPEED	LFO DEPTH
2	TEMPO FLANGER	TEMPO FLANGER	DRY/WET	LFO SPEED	LFO DEPTH
3	TEMPO PHASER	TEMPO PHASER	LFO DEPTH	LFO SPEED	FEEDBACK LEVEL
4	ENSEMBLE DETUNE	ENSEMBLE DETUNE	DRY/WET	DETUNE	SPREAD
5	AUTO PAN	AUTO PAN	L/R DEPTH	LFO SPEED	LFO WAVE
6	TREMOLO	TREMOLO	AM DEPTH	LFO SPEED	PM DEPTH
7	VCM AUTO WAH	VCM AUTO WAH	SPEED	RESONANCE - OFFSET	OUTPUT
8	RING MODULATOR	RING MODULATOR	DRY/WET	OSC FREQ	LFO DEPTH

18.4.7 DUCKER

No.	NAME	TYPE	PARAMETER 1	PARAMETER 2	PARAMETER 3
1	DUCKER - SETTING 1	UNI COMP DOWN	SIDE CHAIN LEVEL	ATTACK	RELEASE
2	DUCKER - SETTING 2				
3	DUCKER - SETTING 3				
4	DUCKER - SETTING 4				
5	DUCKER - SETTING 5				
6	DUCKER - SETTING 6				
7	DUCKER - SETTING 7				
8	DUCKER - SETTING 8				

18.4.8 OTHER

NO.	NAME	TYPE	PARAMETER 1	PARAMETER 2	PARAMETER 3
1	BEAT REPEAT	BEAT REPEAT	REPEAT & LENGTH	GATE TIME	PLAY SPEED
2	TALKING MODULATOR	TALKING - MODULATOR	VOWEL	MOVE SPEED	DRIVE
3	ROTARY SPEAKER 1 - SLOW	ROTARY SPEAKER 1	SPEED CONTROL	ROTOR/HORN - BALANCE	MIC L-R ANGLE
4	ROTARY SPEAKER 2 - FAST	ROTARY SPEAKER 2	SPEED CONTROL	ROTOR/HORN - BALANCE	MODULATION - DEPTH
5	HARMONIC ENHANCER	HARMONIC - ENHANCER	MIX LEVEL	DRIVE	HPF CUTOFF - FREQUENCY
6	AUTO SYNTH	AUTO SYNTH	MOD DEPTH	AM DEPTH	DELAY LEVEL
7	SLICE	SLICE	DRY/WET	GATE TIME	DIVIDE TYPE
8	VINYL BREAK	VINYL BREAK	BREAK	SPEED	SPEED ADJUST

18.5 SINGLE EFFECT Presets

18.5.1 FILTER

NO.	NAME	TYPE	PARAMETER 1	PARAMETER 2	PARAMETER 3
1	LPF - NO RESONANCE	CONTROL FILTER	CUTOFF	RESONANCE	OUTPUT LEVEL
2	LPF - LOW RESONANCE				
3	LPF - MID RESONANCE				
4	LPF - HIGH RESONANCE				
5	HPF - NO RESONANCE				
6	HPF - LOW RESONANCE				
7	HPF - MID RESONANCE				
8	HPF - HIGH RESONANCE				

18.5.2 REVERB

NO.	NAME	TYPE	PARAMETER 1	PARAMETER 2	PARAMETER 3
1	SMALL ROOM 1	SPX ROOM	DRY/WET	REVERB TIME	LPF CUTOFF - FREQUENCY
2	SMALL ROOM 2	SPX ROOM			
3	MID ROOM	SPX ROOM			
4	SMALL HALL	SPX HALL			
5	MID HALL	SPX HALL			
6	STAGE	SPX STAGE			
7	GATED REVERB	GATED REVERB		ROOM SIZE	
8	REVERSE REVERB	REVERSE REVERB			

18.5.3 DELAY

NO.	NAME	TYPE	PARAMETER 1	PARAMETER 2	PARAMETER 3
1	TEMPO DELAY 4TH	TEMPO DELAY - STEREO	DRY/WET	DELAY TIME	FEEDBACK
2	PING PONG DELAY 4TH	TEMPO CROSS - DELAY		DELAY TIME L>R & DELAY TIME R>L	
3	TEMPO DELAY 8TH DOT	TEMPO DELAY - STEREO		DELAY TIME	
4	TEMPO DELAY 8TH	TEMPO DELAY - STEREO		DELAY TIME	
5	PING PONG DELAY 8TH	TEMPO CROSS - DELAY		DELAY TIME L>R & DELAY TIME R>L	
6	TEMPO DELAY 16TH	TEMPO DELAY - STEREO		DELAY TIME	
7	ANALOG DELAY - MODERN	ANALOG DELAY - MODERN		DELAY TIME	
8	ANALOG DELAY RETRO	ANALOG DELAY - RETRO		DELAY TIME	

18.5.4 COMPRESSOR

NO.	NAME	TYPE	PARAMETER 1	PARAMETER 2	PARAMETER 3
1	COMP - SETTING 1	UNI COMP DOWN	RATIO	THRESHOLD	MAKE UP GAIN
2	COMP - SETTING 2				
3	COMP - SETTING 3				
4	COMP - SETTING 4				
5	COMP - SETTING 5				
6	COMP - SETTING 6				
7	COMP - SETTING 7				
8	COMP - SETTING 8				

18.5.5 DISTORTION

NO.	NAME	TYPE	PARAMETER 1	PARAMETER 2	PARAMETER 3
1	WAVE FOLDER – SATURATION	WAVE FOLDER	DRY/WET	FOLD	INPUT LEVEL
2	AMP SIMULATOR 2 - SETTING 1	AMP SIMULATOR 2	DRY/WET	OVERDRIVE	LPF CUTOFF - FREQUENCY
3	AMP SIMULATOR 2 - SETTING 2	AMP SIMULATOR 2	DRY/WET	OVERDRIVE	LPF CUTOFF - FREQUENCY
4	JAZZ COMBO	JAZZ COMBO	DISTORTION	DEPTH	TREBLE
5	AMP SIMULATOR 1	AMP SIMULATOR 1	DRY/WET	OVERDRIVE	PRESENCE
6	SMALL STEREO	SMALL STEREO	DIST DRIVE	DIST TONE	DIST PRESENCE
7	BIT CRUSHER	BIT CRUSHER	SAMPLE RATE	BIT	DRY/WET
8	DIGITAL TURNTABLE	DIGITAL TURNTABLE	NOISE LEVEL	CLICK LEVEL	DRY SEND TO - NOISE

18.5.6 MODULATION

NO.	NAME	TYPE	PARAMETER 1	PARAMETER 2	PARAMETER 3
1	SPX CHORUS	SPX CHORUS	DRY/WET	LFO SPEED	LFO DEPTH
2	TEMPO FLANGER	TEMPO FLANGER	DRY/WET	LFO SPEED	LFO DEPTH
3	TEMPO PHASER	TEMPO PHASER	LFO DEPTH	LFO SPEED	FEEDBACK LEVEL
4	ENSEMBLE DETUNE	ENSEMBLE DETUNE	DRY/WET	DETUNE	SPREAD
5	AUTO PAN	AUTO PAN	L/R DEPTH	LFO SPEED	LFO WAVE
6	TREMOLO	TREMOLO	AM DEPTH	LFO SPEED	PM DEPTH
7	VCM AUTO WAH	VCM AUTO WAH	SPEED	RESONANCE – OFFSET	OUTPUT
8	RING MODULATOR	RING MODULATOR	DRY/WET	OSC FREQ	LFO DEPTH

18.5.7 DUCKER

NO.	NAME	TYPE	PARAMETER 1	PARAMETER 2	PARAMETER 3
1	DUCKER - SETTING 1	UNI COMP DOWN	SIDE CHAIN LEVEL	ATTACK	RELEASE
2	DUCKER - SETTING 2				
3	DUCKER - SETTING 3				
4	DUCKER - SETTING 4				
5	DUCKER - SETTING 5				
6	DUCKER - SETTING 6				
7	DUCKER - SETTING 7				
8	DUCKER - SETTING 8				

18.5.8 OTHER

NO.	NAME	TYPE	PARAMETER 1	PARAMETER 2	PARAMETER 3
1	BEAT REPEAT	BEAT REPEAT	REPEAT & LENGTH	GATE TIME	FREEZE
2	TALKING MODULATOR	TALKING - MODULATOR	VOWEL	MOVE SPEED	DRIVE
3	ROTARY SPEAKER 1 - SLOW	ROTARY SPEAKER 1	SPEED CONTROL	ROTOR/HORN - BALANCE	MIC L-R ANGLE
4	ROTARY SPEAKER 2 - FAST	ROTARY SPEAKER 2	SPEED CONTROL	ROTOR/HORN - BALANCE	MODULATION - DEPTH
5	HARMONIC ENHANCER	HARMONIC - ENHANCER	MIX LEVEL	DRIVE	HPF CUTOFF - FREQUENCY
6	AUTO SYNTH	AUTO SYNTH	MOD DEPTH	AM DEPTH	DELAY LEVEL
7	SLICE	SLICE	DRY/WET	GATE TIME	DIVIDE TYPE
8	VINYL BREAK	VINYL BREAK	BREAK	SPEED	SPEED ADJUST

18.6 SEND EFFECT Presets

18.6.1 REVERB

NO.	NAME	TYPE	PARAMETER 1	PARAMETER 2	PARAMETER 3
1	HD ROOM	HD ROOM	REVERB TIME	ROOM SIZE	HIGH DAMP - FREQUENCY
2	R3 ROOM	R3 ROOM		DIFFUSION	LPF CUTOFF - FREQUENCY
3	R3 HALL	R3 HALL		DIFFUSION	LPF CUTOFF - FREQUENCY
4	HD HALL	HD HALL		ROOM SIZE	HIGH DAMP - FREQUENCY
5	R3 PLATE	R3 PLATE		DIFFUSION	LPF CUTOFF - FREQUENCY
6	HD PLATE	HD PLATE		PLATE TYPE	HIGH DAMP - FREQUENCY
7	SPX STAGE	SPX STAGE		DIFFUSION	LPF CUTOFF - FREQUENCY
8	REV X HALL	REV X HALL		ROOM SIZE	LPF CUTOFF - FREQUENCY

18.6.2 DELAY

NO.	NAME	TYPE	PARAMETER 1	PARAMETER 2	PARAMETER 3
1	TEMPO DELAY 4TH	TEMPO DELAY - STEREO	DELAY TIME	FEEDBACK LEVEL	FEEDBACK - HIGH DAMP
2	PING PONG DELAY 4TH	TEMPO CROSS - DELAY	DELAY TIME L>R & DELAY TIME R>L		FEEDBACK - HIGH DAMP
3	TEMPO DELAY 8TH DOT	TEMPO DELAY - STEREO	DELAY TIME		FEEDBACK - HIGH DAMP
4	TEMPO DELAY 8TH	TEMPO DELAY - STEREO	DELAY TIME		FEEDBACK - HIGH DAMP
5	PING PONG DELAY 8TH	TEMPO CROSS - DELAY	DELAY TIME L>R & DELAY TIME R>L		FEEDBACK - HIGH DAMP
6	TEMPO DELAY 16TH	TEMPO DELAY - STEREO	DELAY TIME		FEEDBACK - HIGH DAMP
7	ANALOG DELAY - MODERN	ANALOG DELAY - MODERN	DELAY TIME		DELAY INPUT - LEVEL
8	ANALOG DELAY RETRO	ANALOG DELAY - RETRO	DELAY TIME		DELAY INPUT - LEVEL

18.7 Description of Sound Parameters

Parameter	Description
SOUND SELECT	Selects the type of sound.
PITCH	Sets pitches by half-step intervals.
PAN	Adjusts the left/right stereo image.
VOLUME	Adjusts the volume.
AEG ATTACK	Determines the time from when the key is pressed until the volume reaches the level set by the attack level.
AEG DECAY/RELEASE	DECAY: Sets the time from when the volume set at the attack level is reached until the volume set at the decay level is reached. RELEASE: Sets the time from when the keyboard key is released until the note fades out.
LP-HP FILTER CUTOFF	Sets the cutoff frequencies for the low-pass and high-pass filters.
LP-HP FILTER RESONANCE	Applies resonance to the low-pass and high-pass filters.
REVERB SEND	Sets the amount of signal sent to the reverb effect (send level). The larger the value, the deeper the reverb.
DELAY SEND	Sets the amount of signal sent to the delay effect (send level). The larger the value, the stronger the delay.
EQ HIGH GAIN	Sets the amount of gain for increasing or decreasing the high frequency range with the EQ.
EQ LOW GAIN	Sets the amount of gain for increasing or decreasing the low frequency range with the EQ.
MONO/POLY/CHORD	Selects the voicing method. MONO: single tone, POLY: multiple tones, CHORD: chords
PORTAMENTO TIME	Sets the time it takes for the portamento to change pitch or the speed of the change in pitch. The larger the value, the longer it takes to change the pitch and the slower the pitch change.
ARPEGGIATOR TYPE	Turns on/off and switches the type of arpeggiator (a function that plays individual notes of a chord one by one).
ARPEGGIATOR GATE TIME	Sets the gate time for the arpeggiator.
ARPEGGIATOR SPEED	Sets the speed of the arpeggiator.
FM ALGORITHM	Selects from 12 different FM algorithms (how the operators are connected).
MODULATOR AMOUNT	Collectively changes the level of operators acting as a MODULATOR.
MODULATOR FREQUENCY	Collectively changes the FREQUENCY parameters of an operator acting as a MODULATOR.

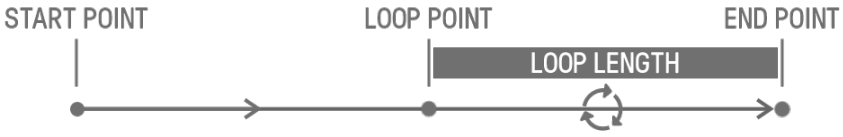
Parameter	Description
MODULATOR FEEDBACK	Collectively changes the FEEDBACK parameters of an operator acting as a MODULATOR.
START POINT	Determines the starting position of a sample.
END POINT	Determines the end position of a sample.
LOOP ON/OFF	Toggles between holding down the key to repeatedly play the sample (ON), or playing it once each time you press the key (OFF).
LOOP LENGTH	<p>Determines the length of the loop playback section. Playback begins from the START POINT, and when it reaches the END POINT, it returns to the LOOP POINT. LOOP LENGTH is the length from the LOOP POINT to the END POINT.</p> <p>(Overview)</p> 
PEG ATTACK LEVEL	Determines the attack level of the PEG (Pitch Envelope Generator). The pitch at the beginning of the tone changes.
PEG ATTACK TIME	Determines the attack time of the PEG (Pitch Envelope Generator). This is the time that elapses between the press of a key and the pitch reaching the level set by the PEG ATTACK LEVEL.
PEG DECAY LEVEL	Determines the decay level of the PEG (Pitch Envelope Generator). In this case, the decay level refers to the next pitch reached after the pitch set in PEG ATTACK LEVEL is reached.
PEG DECAY TIME	Determines the decay time of the PEG (Pitch Envelope Generator). This is the time that elapses between the pitch set in PEG ATTACK LEVEL and the pitch set in PEG DECAY LEVEL.

18.8 Open-source Software

The firmware for SEQTRAK contains open-source software.

Copyright information and terms of use for each open-source software can be found on the downloads page of the following website.

<https://www.yamaha.com/2/seqtrak/>

© 2024 Yamaha Corporation
Published 01/2025
YJ-C0