



AV Receiver

RX-S601
RX-S601D
Owner's Manual

Read the supplied booklet "Safety Brochure" before using the unit.

English

CONTENTS

Accessories	5
-------------------	---

FEATURES 6

What you can do with the unit	6
-------------------------------------	---

Part names and functions	8
--------------------------------	---

Front panel	8
Front display (indicators)	9
Rear panel	10
Remote control	11

PREPARATIONS 12

General setup procedure	12
-------------------------------	----

1 Placing speakers	13
--------------------------	----

2 Connecting speakers	16
-----------------------------	----

5.1-channel system	16
Connecting front speakers that support bi-amp connections	17
Connecting Zone2 speakers	17

Input/output jacks and cables	18
-------------------------------------	----

3 Connecting a TV	19
-------------------------	----

4 Connecting playback devices	20
-------------------------------------	----

Connecting video devices (such as BD/DVD players)	20
Connecting audio devices (such as CD players)	22
Connecting to the jack on the front panel	22

5 Connecting the radio antennas	23
---------------------------------------	----

6 Preparing for connecting to a network	24
---	----

7 Connecting the power cable	25
------------------------------------	----

8 Selecting an on-screen menu language	26
--	----

9 Optimizing the speaker settings automatically (YPAO)	27
--	----

Error messages	29
Warning messages	30

10 Connecting to a network wirelessly	31
---	----

Selecting the connection method	31
Connecting the unit to a wireless network	32
Connecting a mobile device to the unit directly (Wireless Direct)	39

PLAYBACK 41

Basic playback procedure	41
--------------------------------	----

Selecting the input source and favorite settings with one touch	
---	--

(SCENE)	42
---------------	----

Selecting a registered scene	42
Configuring scene assignments	42

Selecting the sound mode	43
--------------------------------	----

Enjoying stereoscopic sound fields (CINEMA DSP 3D)	44
Enjoying unprocessed playback	46
Enjoying pure high fidelity sound (direct playback)	47
Enhancing the bass (Extra Bass)	47
Enjoying compressed music with enhanced sound (Compressed Music Enhancer)	47

Listening to FM/AM radio (RX-S601)	48
--	----

Setting the frequency steps	48
Selecting a frequency for reception	48
Registering favorite radio stations (presets)	49
Radio Data System tuning	51

Listening to DAB radio (RX-S601D)	52
---	----

Preparing the DAB tuning	52
Selecting a DAB radio station for reception	52
Registering favorite DAB radio stations (presets)	53
Displaying the DAB information	54
Checking reception strength of each DAB channel label	55

Listening to FM radio (RX-S601D)	56
Selecting a frequency for reception	56
Registering favorite FM radio stations (presets)	57
Radio Data System tuning	59
Playing back music via BLUETOOTH	60
Playback BLUETOOTH device music on the unit	60
Playing back iPod music	61
Connecting an iPod	61
Playback of iPod content	61
Playing back music with AirPlay	64
Playback of iTunes/iPod music contents	64
Playing back music stored on a USB storage device	66
Connecting a USB storage device	66
Playback of USB storage device contents	66
Playing back music stored on media servers (PCs/NAS)	69
Media sharing setup	69
Playback of PC music contents	70
Listening to Internet radio	72
Playback of Internet radio	72
Registering favorite Internet radio stations (bookmarks)	74
Playing back music in multiple rooms (multi-zone)	75
Preparing Zone2	75
Controlling Zone2	76
Useful functions	78
Registering favorite items (shortcut)	78
Switching information on the front display	79
Configuring playback settings for different playback sources	
(Option menu)	80
Option menu items	80

CONFIGURATIONS

84

Configuring various functions (Setup menu)	84
Setup menu items	85
Speaker	88
HDMI	91
Sound	93
ECO	96
Function	97
Network	99
Bluetooth	101
Language	102
Configuring the system settings (ADVANCED SETUP menu)	103
ADVANCED SETUP menu items	103
Changing the speaker impedance setting (SP IMP.)	103
Selecting the remote control ID (REMOTE ID)	104
Changing the FM/AM tuning frequency setting (TU)	104
Switching the video signal type (TV FORMAT)	104
Restoring the default settings (INIT)	104
Updating the firmware (UPDATE)	105
Checking the firmware version (VERSION)	105
Updating the unit's firmware via the network	106

APPENDIX

107

Frequently asked questions	107
Troubleshooting	109
Power, system and remote control	109
Audio	111
Video	113
FM/AM radio (AM radio feature is available only on RX-S601.)	114
DAB radio (RX-S601D)	114
USB and network	115
Bluetooth	116
Error indications on the front display	117
Glossary	118
Audio information	118
HDMI and video information	119
Network information	119
Yamaha technologies	120
Supported devices and file formats	120
Video signal flow	121
Information on HDMI	122
HDMI Control	122
Audio Return Channel (ARC)	123
HDMI signal compatibility	124
Trademarks	125
Specifications	126
Index	129

Accessories

Check that the following accessories are supplied with the product.

Remote control

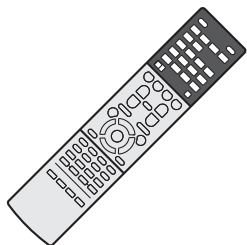

Batteries (AAA, R03, UM-4) (x2)

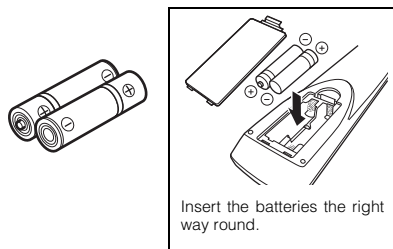

AM antenna (RX-S601)



FM antenna (RX-S601)

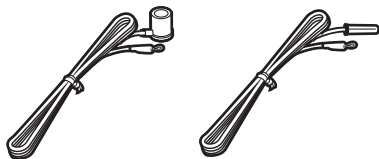

*One of the above is supplied depending on the region of purchase.

DAB/FM antenna (RX-S601D)

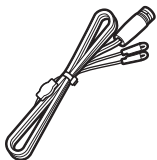

YPAO microphone

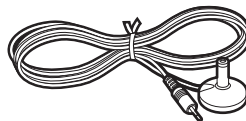

CD-ROM (Owner's Manual)

Easy Setup Guide



Safety Brochure

Operating range of the remote control

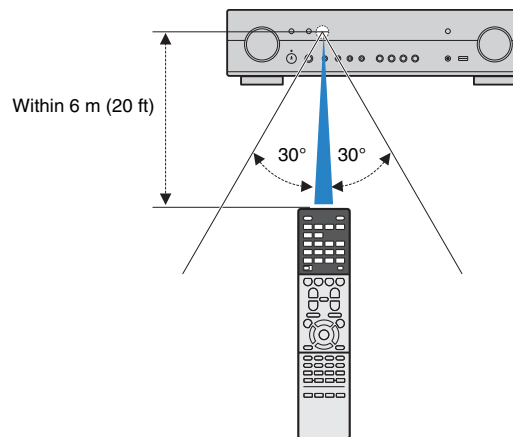
- Point the remote control at the remote control sensor on the unit and remain within the operating range shown below.



- The illustrations of the main unit used in this manual are of the RX-S601 (U.S.A. model), unless otherwise specified.

- Some features are not available in certain regions.
- Due to product improvements, specifications and appearance are subject to change without notice.
- This manual explains operations using the supplied remote control.
- This manual describes all the "iPod" and "iPhone" as the "iPod". "iPod" refers to both "iPod" and "iPhone" unless otherwise specified.
-  indicates precautions for use of the unit and its feature limitations.
-  indicates supplementary explanations for better use.

FEATURES

What you can do with the unit

Wide variety of supported content

- iPod/iPhone ➔ p.61
- USB ➔ p.66
- Media server (PC/NAS) ➔ p.69
- Internet radio ➔ p.72
- AirPlay ➔ p.64
- BLUETOOTH ➔ p.60

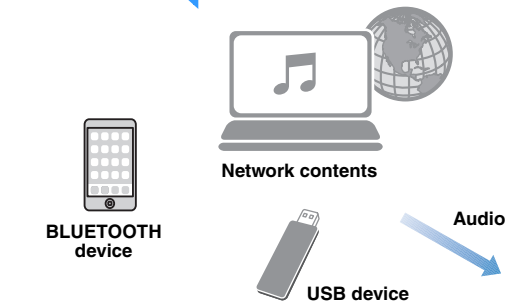

4K Ultra HD signal and HDCP 2.2 supported

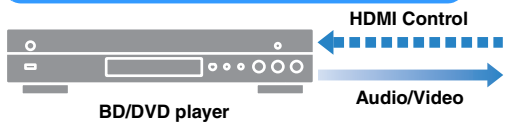

Wireless connection to a network

➔ p.24

Change the input source and favorite settings with one touch (SCENE)

➔ p.42

Supports 2- to 5.1-channel speaker system.

Allows you to enjoy your favorite acoustic spaces in various styles.

- Automatically optimizing the speaker settings to suit your room (YPAO) ➔ p.27
- Reproducing stereo or multichannel sounds with the sound fields like actual movie theaters and concert halls (CINEMA DSP) ➔ p.44
- Enjoying compressed music with enhanced sound (Compressed Music Enhancer) ➔ p.47
- Playing back music in multiple rooms ➔ p.75

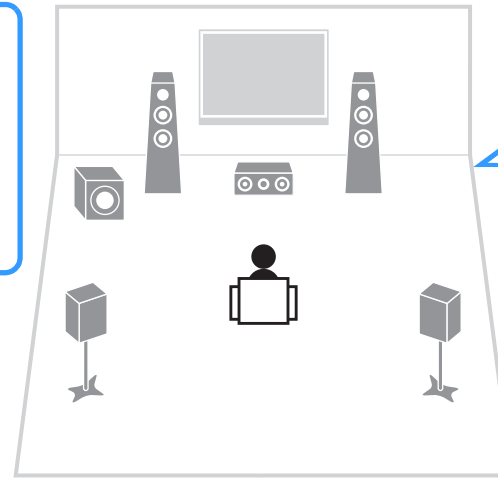

Speakers

Audio

HDMI Control

Audio

Audio/Video

AV receiver (the unit)

TV

Sequential operation of a TV, AV receiver, and BD/DVD player (HDMI Control)

➔ p.122

TV remote control

Full of useful functions!

❑ Connecting various devices (p.20)

A number of HDMI jacks and various input/output jacks on the unit allow you to connect video devices (such as BD/DVD players), audio devices (such as CD players), game consoles, portable audio player, and other devices.

❑ Playing back TV audio in surround sound with a single HDMI cable connection (Audio Return Channel: ARC) (p.19)

When using an ARC-compatible TV, you only need one HDMI cable to enable video output to the TV, audio input from the TV, and the transmission of HDMI Control signals.

❑ Creating 3-dimensional sound fields (p.44)

The Virtual Presence Speaker (VPS) function allows you to create a 3-dimensional sound field that spreads up and deep in your own room (CINEMA DSP 3D).

❑ Surround playback with 5 speakers placed in front (p.45)

You can enjoy the surround sound even when the surround speakers are placed in front.

❑ Enjoying pure high fidelity sound (p.47)

When the direct playback mode is enabled, the unit plays back the selected source with the least circuitry, which lets you to enjoy Hi-Fi sound quality.

❑ Listening to FM/AM radio (p.48) (RX-S601)

❑ Listening to DAB radio (p.52) and FM radio (p.56) (RX-S601D)

❑ Low power consumption

The ECO mode (power saving function) reduces the unit's power consumption and helps to create an eco-friendly home theater system (p.96).

About “AV SETUP GUIDE”

❑ Application for tablets “AV SETUP GUIDE”



AV SETUP GUIDE is an application that assists you with cable connections between AV receiver and source devices as well as AV receiver setup. This app guides you through the various settings such as speaker connections, TV and source device connections and assigning the power amp.

Functions:

- 1) Connection support guide
 - Speaker connection
 - TV/source devices connection
- 2) Setup support guide
 - Automatic network setup of HDMI, power amp assign, etc.
 - Various setup assistance with illustrations.
 - YPAO setting guidance
- 3) View owner's manual

* This application is for tablets only.

For details, search for “AV SETUP GUIDE” on the App Store or Google Play.

About “AV CONTROLLER”

❑ Application for smartphone / tablets “AV CONTROLLER”



AV CONTROLLER provides you the flexibility to control the available inputs, volume, mute and power commands. It lets users change a song from Internet Radio, USB and command FM/AM tuners or any other internally available source.

Functions:

- Power on/off
- Volume up/down
- Mute
- Music Play
- Input Selection
- DSP Mode Selection
- SCENE selection
- Blu-ray player fundamental control
- Seamless control between the Yamaha AV receiver and Blu-ray player
- Demo mode - Explains how to use this app

For details, search for “AV CONTROLLER” on the App Store or Google Play.

Part names and functions

Front panel

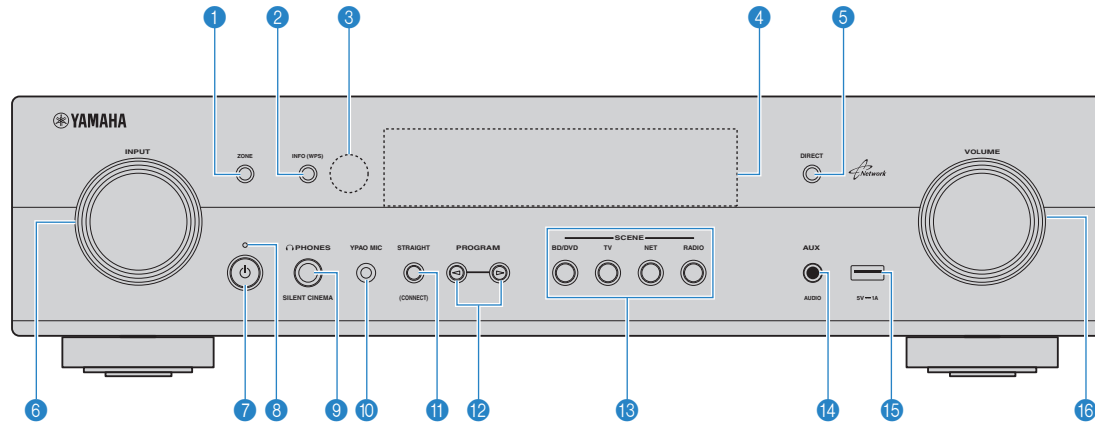

1 ZONE key

Enables/disables the audio output to Zone2 (p.75).

2 INFO (WPS) key

Selects the information displayed on the front display (p.79).
Enters the wireless network connection setup (WPS push button configuration) by holding down for 3 seconds (p.34).

3 Remote control sensor

Receives remote control signals (p.5).

4 Front display

Displays information (p.9).

5 DIRECT key

Enables/disables the direct playback mode (p.47).

6 INPUT knob

Select an input source.

7 Power key

Turns on/off (standby) the unit.

8 Standby indicator

Lights up when the unit is in standby mode under any of the following conditions.

- HDMI Control is enabled (p.91)
- Standby Through is enabled (p.91)
- Network Standby is enabled (p.100)
- An iPod is being charged (p.61)

9 PHONES jack

For connecting headphones.

10 YPAO MIC jack

For connecting the supplied YPAO microphone (p.27).

11 STRAIGHT key

Enables/disables the straight decode mode (p.46).

12 PROGRAM keys

Select a sound program or a surround decoder (p.43).

13 SCENE keys

Select the registered input source and sound program with one touch. Also, turns on the unit when it is in standby mode (p.42).

14 AUX jack

For connecting devices, such as portable audio players (p.22).

15 USB jack

For connecting a USB storage device (p.66) or an iPod (p.61).

16 VOLUME knob

Adjusts the volume.

Front display (indicators)

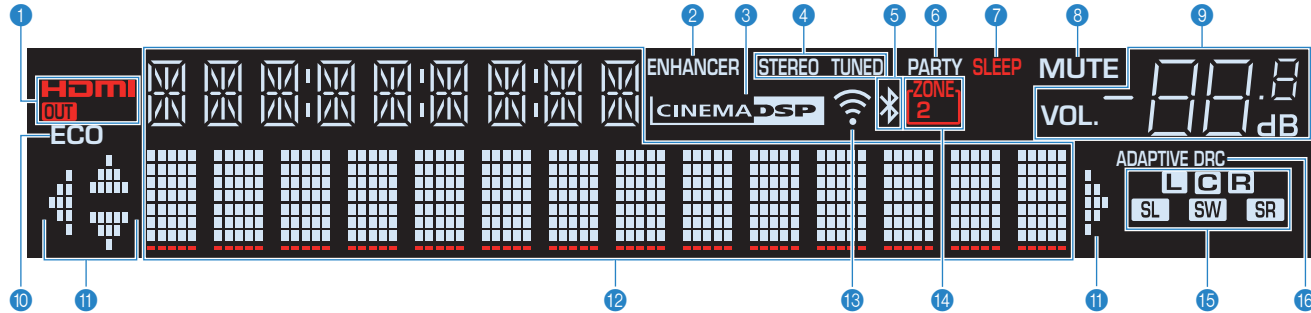

1 HDMI

Lights up when HDMI signals are being input or output.

OUT

Lights up when HDMI signals are being output.

2 ENHANCER

Lights up when Compressed Music Enhancer (p.47) is working.

3 CINEMA DSP

Lights up when CINEMA DSP (p.44) or CINEMA DSP 3D (p.44) is working.

4 STEREO

Lights up when the unit is receiving a stereo FM radio signal.

TUNED

Lights up when the unit is receiving an FM/AM radio station (RX-S601) or FM radio station (RX-S601D) signal.

5 BLUETOOTH indicator

Light up while the unit is connecting to a BLUETOOTH device.

6 PARTY

Lights up when the unit is in the party mode. (p.77)

7 SLEEP

Lights up when the sleep timer is on.

8 MUTE

Blinks when audio is muted.

9 Volume indicator

Indicates the current volume.

10 ECO

Lights up when the eco mode (p.96) is enabled.

11 Cursor indicators

Indicate the remote control cursor keys currently operational.

12 Information display

Displays the current status (such as input name and sound mode name). You can switch the information by pressing INFO (p.79).

13 Signal strength indicator

Indicates the strength of the wireless signal (p.31).

14 ZONE 2

Lights up when audio output to Zone2 is enabled (p.75).

15 Speaker indicators

Indicate speaker terminals from which signals are output.

L Front speaker (L)

R Front speaker (R)

C Center speaker

SL Surround speaker (L)

SR Surround speaker (R)

SW Subwoofer

16 ADAPTIVE DRC

Lights up when Adaptive DRC (p.81) is working.

Rear panel

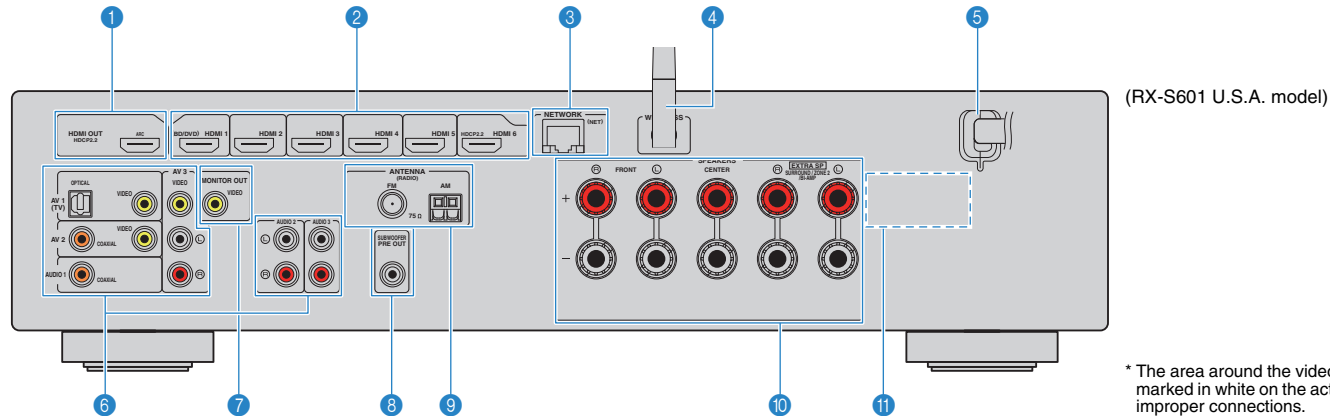

* The area around the video/audio output jacks is marked in white on the actual product to prevent improper connections.

1 HDMI OUT jack

For connecting to an HDMI-compatible TV and outputting video/audio signals (p.19). When using ARC, TV audio signal can also be input through the HDMI OUT jack.

2 HDMI 1–6 jacks

For connecting to HDMI-compatible playback devices and inputting video/audio signals (p.20).

3 NETWORK jack

For a wired connection to a network (p.24).

4 Wireless antenna

For a wireless (Wi-Fi) connection to a network (p.24).

5 Power cable

For connecting to an AC wall outlet (p.25).

6 AV jacks

AUDIO jacks

For connecting to video/audio playback devices and inputting video/audio signals (p.20).

7 MONITOR OUT jack

For connecting to a TV and outputting video signals (p.19).

8 SUBWOOFER PRE OUT jack

For connecting to a subwoofer (with built-in amplifier) (p.16).

9 ANTENNA jacks

For connecting to the radio antennas (p.23).

10 SPEAKERS terminals

For connecting to speakers (p.16).

11 VOLTAGE SELECTOR

(General model only)

Selects the switch position according to your local voltage (p.25).

Remote control

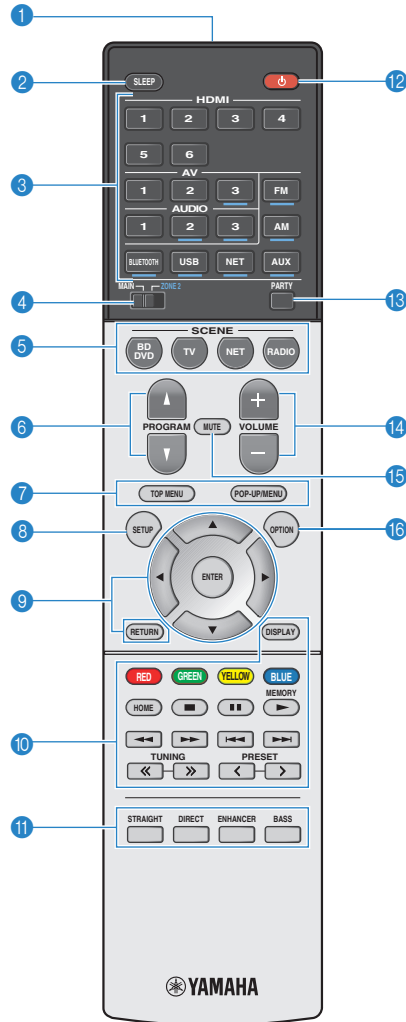

1 Remote control signal transmitter

Transmits infrared signals.

2 SLEEP key

Switches the unit to standby mode automatically after a specified period of time has elapsed (sleep timer). Press repeatedly to set the time (120 min, 90 min, 60 min, 30 min, off).

3 Input selection keys

Select an input source for playback.

You can select directly each input source by pressing the following keys.

- HDMI 1-6** HDMI 1-6 jacks
- AV 1-3** AV 1-3 jacks
- AUDIO 1-3** AUDIO 1-3 jacks
- FM** FM radio
- AM or DAB** AM radio (RX-S601) or DAB radio (RX-S601D)
- BLUETOOTH** BLUETOOTH devices
- USB** USB jack (on the front panel)
- NET** Network sources (press repeatedly to select a desired network source)
- AUX** AUX jack (on the front panel)



- Input selection keys that can be selected for Zone2 are underlined in blue.

4 MAIN/ZONE 2 switch

Changes the zone (main zone or Zone2) that is controlled by the remote control (p.75).

5 SCENE keys

Select the registered input source and sound program with one touch. Also, turns on the unit when it is in standby mode (p.42).

6 PROGRAM keys

Select a sound program or a surround decoder (p.43).

8 SETUP key

Displays the setup menu (p.84).

9 Menu operation keys

- Cursor keys** Select a menu or a parameter.
- ENTER** Confirms a selected item.
- RETURN** Returns to the previous screen.

7 9 10 External device operation keys

Let you perform playback operations when "USB" or "NET" is selected as the input source, or control playback of the HDMI Control-compatible playback device.



- The playback devices must support HDMI Control. However, Yamaha does not assure the operation of all HDMI Control-compatible devices.



- You can assign the unit's functions to the RED/GREEN/YELLOW/BLUE keys (p.98).

10 Radio keys

Operate the FM/AM/DAB radio when "TUNER" is selected as the input source (p.48).

- MEMORY** Registers radio stations as presets.
- PRESET** Select a preset station.
- TUNING** Select the radio frequency.

11 Sound mode keys

Select a sound mode (p.43).

12 (receiver power) key

Turns on/off (standby) the unit.

13 PARTY key

Turns on/off the party mode (p.77).

14 VOLUME keys

Adjust the volume.

15 MUTE key

Mutes the audio output.

16 OPTION key

Displays the option menu (p.80).

PREPARATIONS

General setup procedure

- 1 Placing speakers (p.13)** Select the speaker layout for the number of speakers that you are using and place them in your room.
- 2 Connecting speakers (p.16)** Connect the speakers to the unit.
- 3 Connecting a TV (p.19)** Connect a TV to the unit.
- 4 Connecting playback devices (p.20)** Connect video devices (such as BD/DVD players) and audio devices (such as CD players) to the unit.
- 5 Connecting the radio antennas (p.23)** Connect the supplied FM/AM antennas or DAB/FM antenna to the unit.
- 6 Preparing for connecting to a network (p.24)** Connect the unit to a network with a commercially-available network cable.
- 7 Connecting the power cable (p.25)** After all the connections are complete, plug in the power cable.
- 8 Selecting an on-screen menu language (p.26)** Select the desired on-screen menu language.
- 9 Optimizing the speaker settings automatically (YPAO) (p.27)** Optimize the speaker settings, such as volume balance and acoustic parameters, to suit your room (YPAO).
- 10 Connecting to a network wirelessly (p.31)** Connect the unit to a network wirelessly.

This completes all the preparations. Enjoy playing movies, music, radio and other content with the unit!

1 Placing speakers

Select the speaker layout for the number of speakers that you are using and place the speakers and subwoofer in your room. This section describes the representative speaker layout examples.

Caution

- Under its default settings, the unit is configured for 6-ohm speakers. When connecting 8-ohm speakers, set the unit's speaker impedance to "8 Ω MIN". For details, see "Setting the speaker impedance" (p.15).
- Use a subwoofer with built-in amplifier.
- Be sure to connect the front left and right speakers.

Speaker type	Abbr.	Function	Speaker system (the number of channels)				
			5.1	5.1 (Virtual CINEMA FRONT)	4.1	3.1	2.1
Front (L)	FL	Produce front left/right channel sounds (stereo sounds).	●	●	●	●	●
Front (R)	FR		●	●	●	●	●
Center	C	Produces center channel sounds (such as movie dialogue and vocals).	●	●		●	
Surround (L)	SL	Produce surround left/right channel sounds.	●	●*	●		
Surround (R)	SR		●	●*	●		
Subwoofer	SW	Produces LFE (low-frequency effect) channel sounds and reinforces the bass parts of other channels. This channel is counted as "0.1".	●	●	●	●	●

* Place the surround speakers in front and set "Virtual CINEMA FRONT" (p.89) in the "Setup" menu to "On".



- You can use the Zone2 function or bi-amp connections simultaneously with the 2.1- or 3.1-channel system.

5.1-channel system

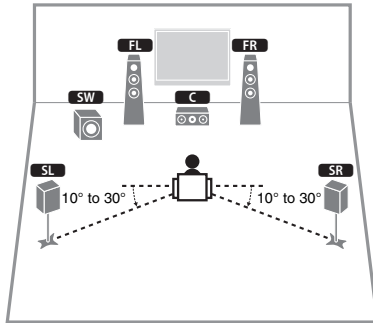

- You can enjoy surround sound even without the center speaker (front 4.1-channel system).
- You can place the subwoofer either in the left or right side.

5.1-channel system (Virtual CINEMA FRONT)

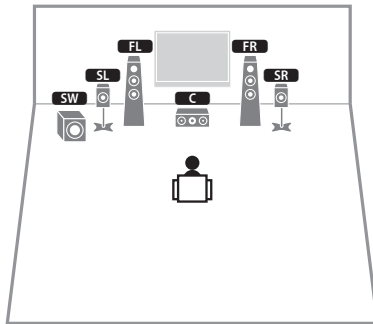

- To utilize this configuration, set "Virtual CINEMA FRONT" (p.89) in the "Setup" menu to "On".



- You can enjoy surround sound even without the center speaker (front 4.1-channel system).
- You can place the subwoofer either in the left or right side.

3.1-channel system

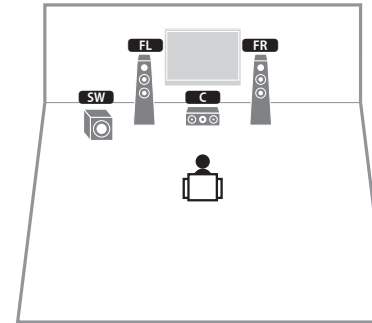

2.1-channel system

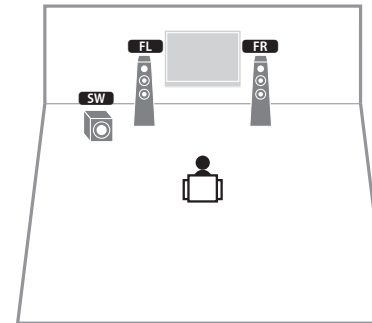

■ Setting the speaker impedance

Under its default settings, the unit is configured for 6-ohm speakers. When connecting 8-ohm speakers, set the speaker impedance to “8 Ω MIN”.

- 1 Before connecting speakers, connect the power cable to an AC wall outlet.**
- 2 While holding down STRAIGHT on the front panel, press ⏻ (power).**

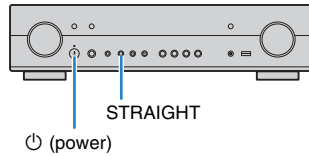

- 3 Check that “SP IMP.” is displayed on the front display.**



- 4 Press STRAIGHT to select “8 Ω MIN”.**
- 5 Press ⏻ (power) to set the unit to standby mode and remove the power cable from the AC wall outlet.**

You are now ready to connect the speakers.

2 Connecting speakers

Connect the speakers placed in your room to the unit. The following diagram provides connections for 5.1-channel system as an example. For other systems, connect speakers while referring to the connection diagram for the 5.1-channel system.

Caution

- Remove the unit's power cable from an AC wall outlet and turn off the subwoofer before connecting the speakers.
- Ensure that the core wires of the speaker cable do not touch one another or come into contact with the unit's metal parts. Doing so may damage the unit or the speakers. If the speaker cables short circuit, "Check SP Wires" will appear on the front display when the unit is turned on.

Cables required for connection (commercially available)

Speaker cables (x the number of speakers)



Audio pin cable (x1: for connecting a subwoofer)



5.1-channel system

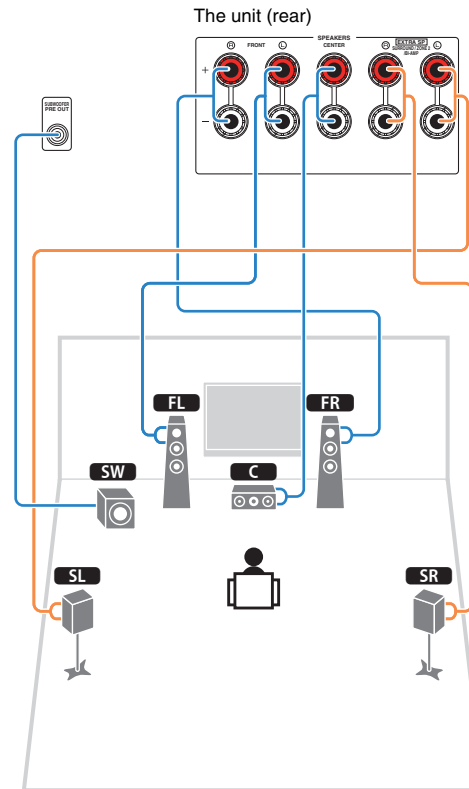

Connecting speaker cables

Speaker cables have two wires. One is for connecting the negative (-) terminal of the unit and the speaker, and the other is for the positive (+) terminal. If the wires are colored to prevent confusion, connect the black wire to the negative and the other wire to the positive terminal.

- ① Remove approximately 10 mm (3/8") of insulation from the ends of the speaker cable and twist the bare wires of the cable firmly together.
- ② Loosen the speaker terminal.
- ③ Insert the bare wires of the cable into the gap on the side (upper right or bottom left) of the terminal.
- ④ Tighten the terminal.

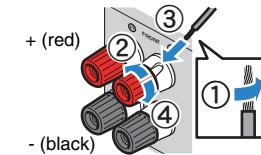

Using a banana plug

(U.S.A., Canada, China, Australia and General models only)

- ① Tighten the speaker terminal.
- ② Insert a banana plug into the end of the terminal.

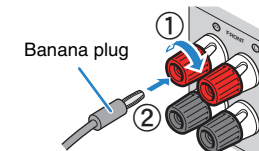

Connecting the subwoofer (with built-in amplifier)

Use an audio pin cable to connect the subwoofer.

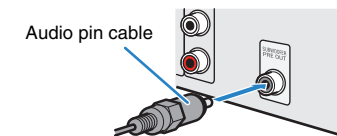

Connecting front speakers that support bi-amp connections

When using front speakers that support bi-amp connections, connect them to the FRONT jacks and SURROUND/ZONE 2/BI-AMP jacks.

To enable the bi-amp function, set "Power Amp Assign" (p.88) in the "Setup" menu to "BI-AMP" after connecting the power cable to an AC wall outlet.

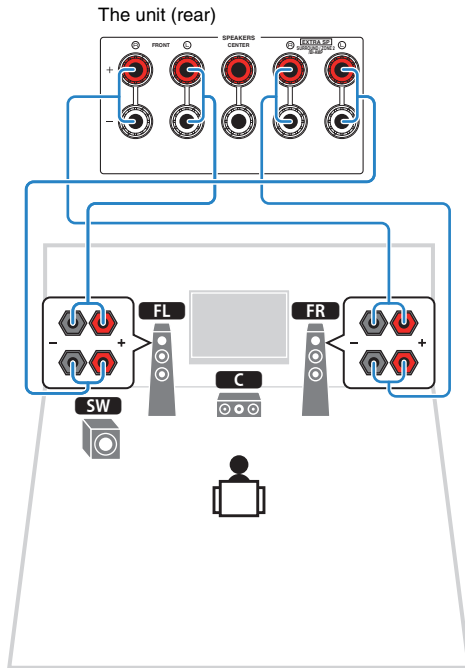

- Surround speakers or Zone2 speakers cannot be used during bi-amp connections.



- The FRONT jacks and SURROUND/ZONE 2/BI-AMP jacks output the same signals.

Caution

- Before making bi-amp connections, remove any brackets or cables that connect a woofer with a tweeter. Refer to the instruction manual of the speakers for details. If you are not making bi-amp connections, make sure that the brackets or cables are connected before connecting the speaker cables.

Connecting Zone2 speakers

The Zone2 function allows you to playback an input source in the room where the unit is installed (main zone) and in another room (Zone2). To connect the Zone2 speakers, see "Playing back music in multiple rooms (multi-zone)" (p.75).



- Surround speakers or bi-amplified front speakers cannot be used while the Zone2 function is enabled.

Input/output jacks and cables

Video/audio jacks

□ HDMI jacks

Transmit digital video and digital sound through a single jack. Use an HDMI cable.



- Use a 19-pin HDMI cable with the HDMI logo. We recommend using a cable less than 5.0 m (16.4 ft) long to prevent signal quality degradation.



- The unit's HDMI jacks support the HDMI Control, Audio Return Channel (ARC), and 3D and 4K Ultra HD video transmission (through output) features.
- Use high speed HDMI cables to enjoy 3D or 4K Ultra HD videos.

Video jacks

□ VIDEO jacks

Transmit analog video signals. Use a video pin cable.



Audio jacks

□ OPTICAL jacks

Transmit digital audio signals. Use a digital optical cable. Remove the tip protector (if available) before using the cable.



□ COAXIAL jacks

Transmit digital audio signals. Use a digital coaxial cable.



□ AUDIO jacks

(Stereo L/R jacks)

Transmit analog stereo audio signals. Use a stereo pin cable (RCA cable).

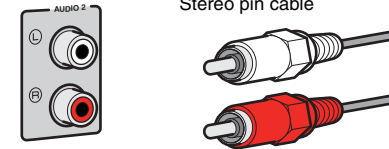

(Stereo mini jack)

Transmits analog stereo audio signals. Use a stereo mini-plug cable.

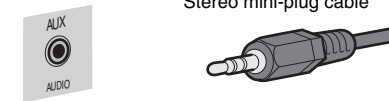

3 Connecting a TV

Connect a TV to the unit so that video input to the unit can be output to the TV. You can also enjoy playback of TV audio on the unit.

To maximize the performance of the unit, we recommend connecting a TV with an HDMI cable.

HDMI connection

Connect the TV to the unit with an HDMI cable and a digital optical cable.

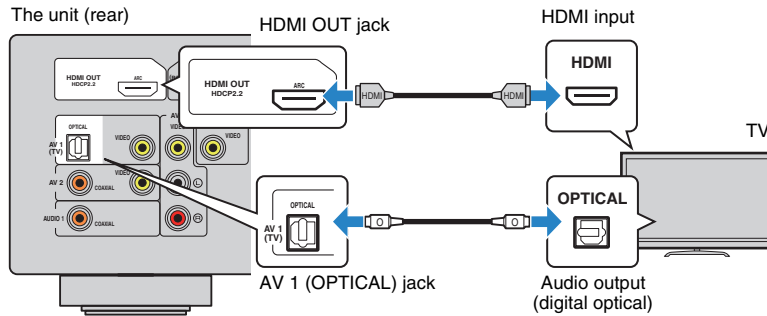

- You do not make a digital optical cable connection between the TV and the unit in the following cases:
 - If your TV supports Audio Return Channel (ARC)
 - If you will receive TV broadcasts only from the set-top box
- If you connect a TV that supports HDMI Control to the unit with an HDMI cable, you can control the unit's power and volume with the TV's remote control.

To use HDMI Control and ARC, you need to configure the HDMI settings on the unit. For details on the settings, see "Information on HDMI" (p.122).

About Audio Return Channel (ARC)

- ARC allows audio signals to travel both ways. If you connect a TV that supports ARC to the unit with a single HDMI cable, you can output video/audio to the TV or input TV audio to the unit.
- When using ARC, connect a TV with an HDMI cable that supports ARC.

Composite video connection

Connect the TV to the unit with a video pin cable and a digital optical cable.

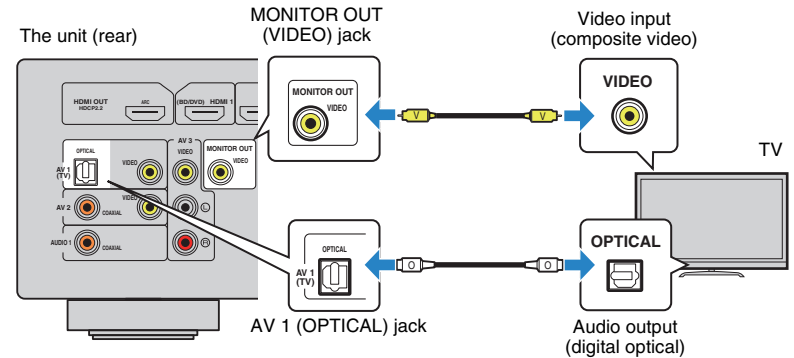

- If you connect your TV to the unit with a cable other than HDMI, video input to the unit via HDMI cannot be output to the TV.
- Operations with TV screen are available only when your TV is connected to the unit via HDMI.



- If you will receive TV broadcasts only from the set-top box, you do not need to make an audio cable connection between the TV and the unit.

4 Connecting playback devices

The unit is equipped with a variety of input jacks including HDMI input jacks to allow you to connect different types of playback devices. For information on how to connect a BLUETOOTH device, an iPod, or a USB storage device, see the following pages.

- Connecting a BLUETOOTH device (p.60)
- Connecting an iPod (p.61)
- Connecting a USB storage device (p.66)

Connecting video devices (such as BD/DVD players)

Connect video devices such as BD/DVD players, set-top boxes (STBs) and game consoles to the unit. Depending on the video/audio output jacks available on your video device, choose one of the following connections. We recommend using an HDMI connection if the video device has an HDMI output jack.



- If the combination of video/audio input jacks available on the unit does not match your video device, change its combination according to the output jacks of your device (p.21).

HDMI connection

Connect a video device to the unit with an HDMI cable.

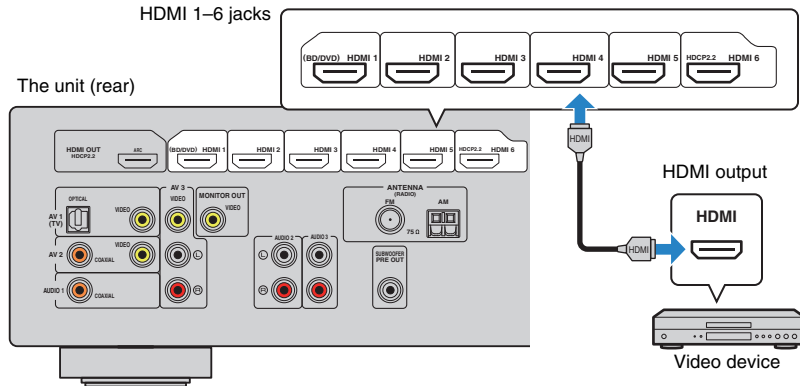

- If you connect a video device to the unit via HDMI, you need to connect your TV to the HDMI OUT jack of the unit (p.19).
- For the HDCP 2.2-compatible HDMI device, use the HDMI 6 jack to connect it.

Composite video connection

Connect a video device to the unit with a video pin cable and an audio cable (digital optical, digital coaxial or stereo pin cable). Choose a set of input jacks (on the unit) depending on the audio output jacks available on your video device.

Output jacks on video device		Input jacks on the unit
Video	Audio	
Composite video	Digital optical	AV 1 (VIDEO + OPTICAL)
	Digital coaxial	AV 2 (VIDEO + COAXIAL)
	Analog stereo	AV 3 (VIDEO + AUDIO)

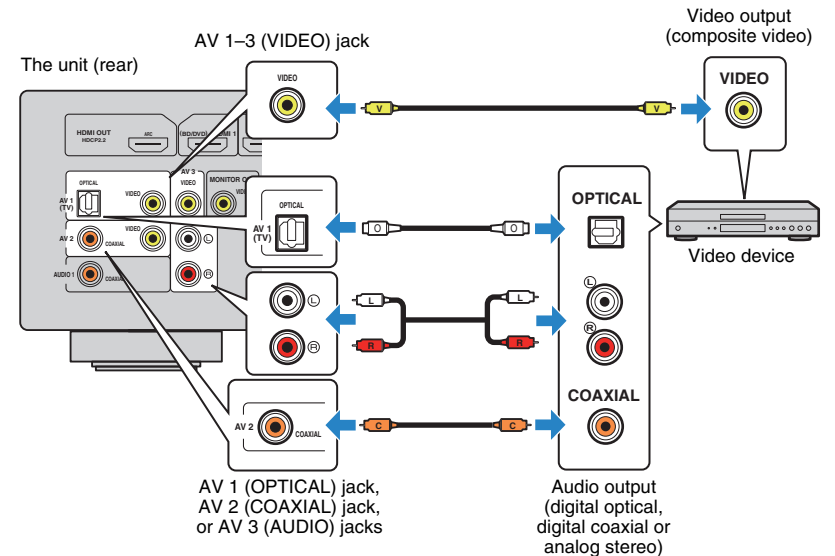

- If you connect a video device to the unit via composite video connection, you need to connect your TV to the MONITOR OUT (VIDEO) jack of the unit (p.20).

■ Changing the combination of video/audio input jacks

If the combination of video/audio input jacks available on the unit does not match your video device, change its combination according to the output jacks of your device. You can connect a video device that has the following video/audio output jacks.

Output jacks on video device		Input jacks on the unit	
Video	Audio	Video	Audio
HDMI	Digital optical	HDMI 1-6	AV 1 (OPTICAL)
	Digital coaxial	HDMI 1-6	AUDIO 1 (COAXIAL) AV 2 (COAXIAL)
	Analog stereo	HDMI 1-6	AV 3 (AUDIO) AUDIO 2-3 (AUDIO)

□ Necessary setting

For example, if you have connected a video device to HDMI 2 and AV 3 (AUDIO) jacks of the unit, change the combination setting as follows.

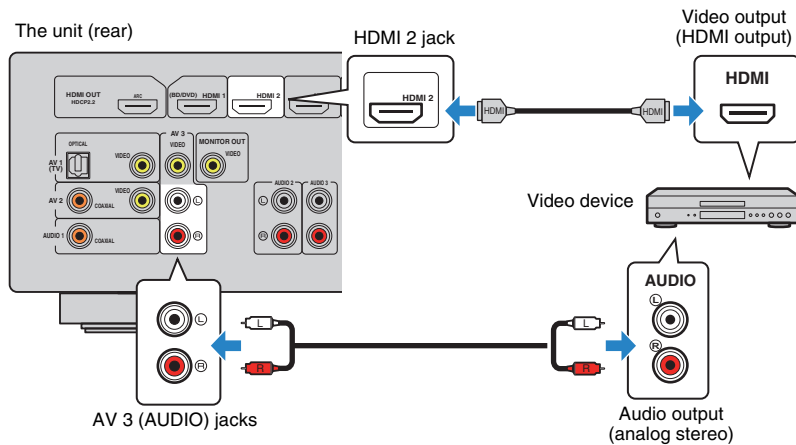

- 1 After connecting external devices (such as a TV and playback devices) and power cable of the unit, turn on the unit.
- 2 Press HDMI 2 to select “HDMI 2” (video input jack to be used) as the input source.

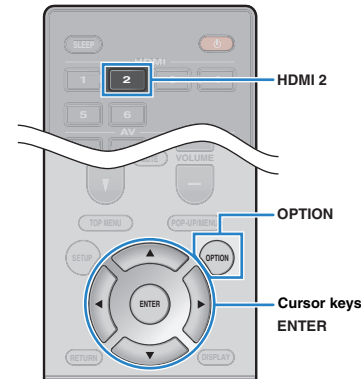

- 3 Press OPTION.
- 4 Use the cursor keys (Δ/∇) to select “Audio In” and press ENTER.



- 5 Use the cursor keys (</>) to select “AV 3” (audio input jack to be used).



- 6 Press OPTION.

This completes the necessary settings.

If you select “HDMI 2” as the input source by pressing HDMI 2, the video/audio played back on the video device will be output from the unit.

Connecting audio devices (such as CD players)

Connect audio devices such as CD players and MD players to the unit. Depending on the audio output jacks available on your audio device, choose one of the following connections.

Audio output jacks on audio device	Audio input jacks on the unit
Digital optical	AV 1 (OPTICAL)
Digital coaxial	AV 2 (COAXIAL) AUDIO 1 (COAXIAL)
Analog stereo	AV 3 (AUDIO) AUDIO 2-3 (AUDIO)

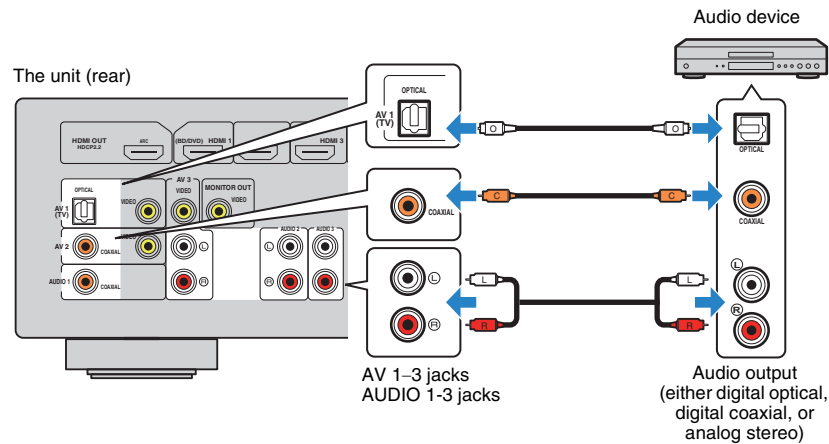

Connecting to the jack on the front panel

Use the AUX jack on the front panel to temporarily connect devices such as portable audio players to the unit.

Before making a connection, stop playback on the device and turn down the volume on the unit.

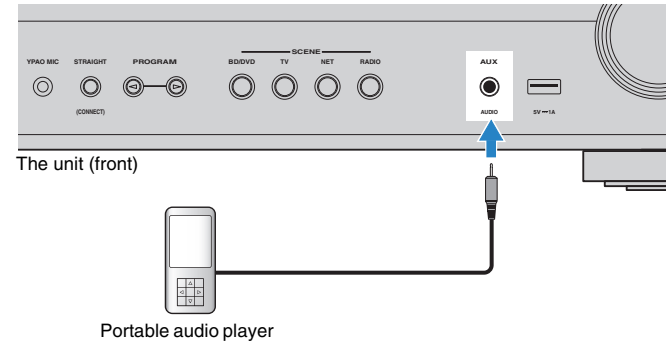

If you select "AUX" as the input source by pressing AUX, the audio played back on the device will be output from the unit.



- You need to prepare the audio cable that matches the output jacks on your device.



- For details on how to connect an USB storage device, see "Connecting a USB storage device" (p.66).

5 Connecting the radio antennas

FM/AM antennas (RX-S601)

Connect the supplied FM/AM antennas to the unit.
Fix the end of the FM antenna to a wall, and place the AM antenna on a flat surface.

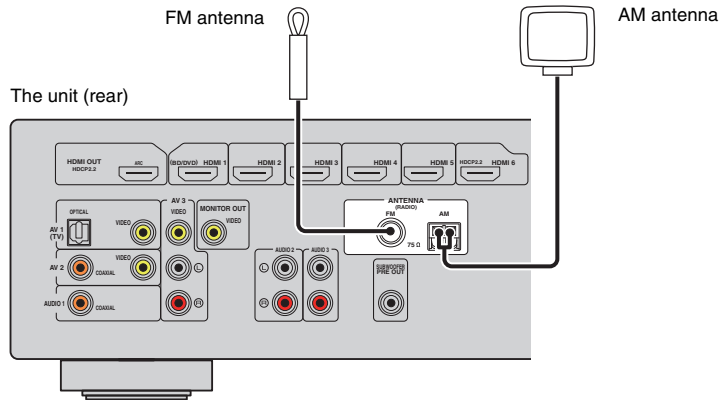

Assembling and connecting the AM antenna

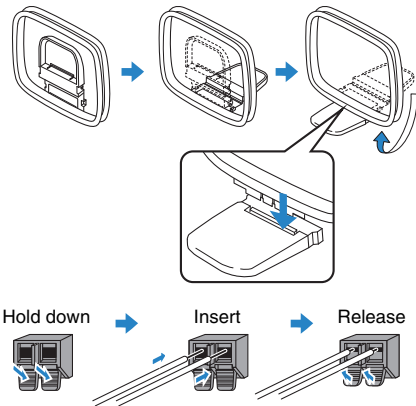

- Unwind only the length of cable needed from the AM antenna unit.
- The wires of the AM antenna have no polarity.

DAB/FM antenna (RX-S601D)

Connect the supplied DAB/FM antenna to the unit and fix the antenna ends to a wall.

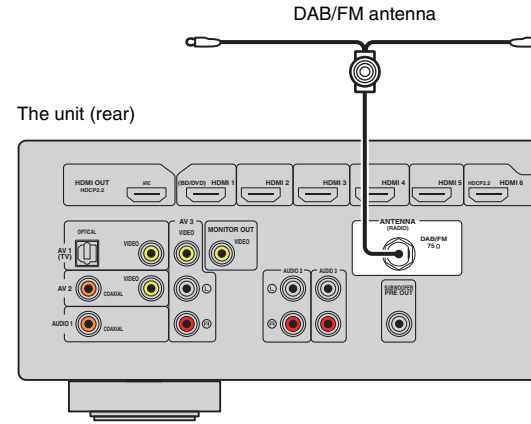

- The antenna should be stretched out horizontally.
- If you cannot obtain good reception on the radio, adjust the height, direction or placement of the DAB/FM antenna.

6 Preparing for connecting to a network

Connect the unit to a router (access point) with a network cable, or prepare the wireless antenna for establishing a wireless network connection.

You can enjoy Internet radio or music files stored on media servers, such as PCs and Network Attached Storage (NAS), on the unit.

Connecting a network cable

Connect the unit to your router with a commercially-available STP network cable (CAT-5 or higher straight cable).

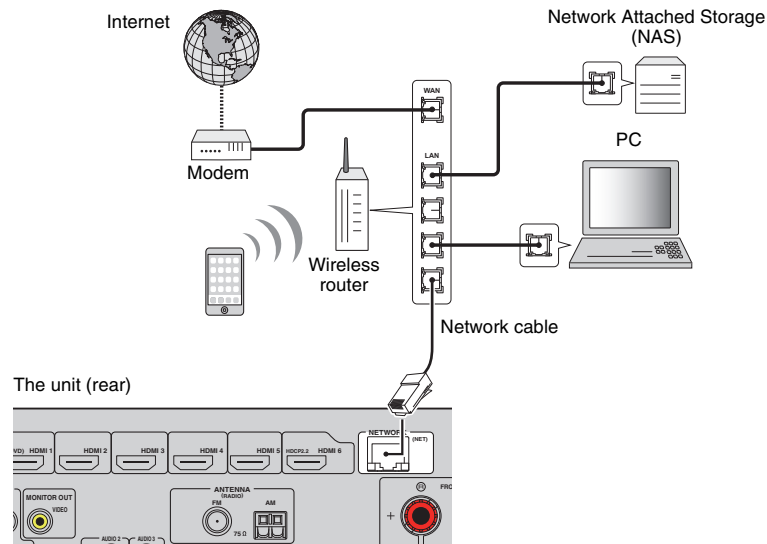

- If you are using a router that supports DHCP, you do not need to configure any network settings for the unit, as the network parameters (such as the IP address) will be assigned automatically to it. You only need to configure the network settings if your router does not support DHCP or if you want to configure the network parameters manually (p.99).
- You can check whether the network parameters (such as IP address) are properly assigned to the unit in "Information" (p.99) in the "Setup" menu.



- Some security software installed on your PC or the firewall settings of network devices (such as a router) may block the access of the unit to the network devices or the Internet. In these cases, configure the security software or firewall settings appropriately.
- Each server must be connected to the same subnet as the unit.
- To use the service via the Internet, broadband connection is strongly recommended.

Preparing a wireless antenna

If you connect the unit wirelessly, erect the wireless antenna.

For information on how to connect the unit to a wireless network, see "Connecting to a network wirelessly" (p.31).

Erect the wireless antenna.

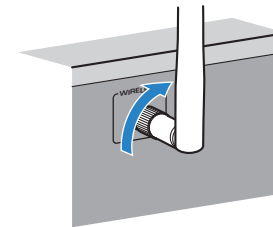

- Do not apply excessive force on the wireless antenna. Doing so may damage the antenna.

7 Connecting the power cable

Before connecting the power cable (General model only)

Set the switch position of VOLTAGE SELECTOR according to your local voltage. Voltages are AC 110–120/220–240 V, 50/60 Hz.



- Make sure you set VOLTAGE SELECTOR of the unit BEFORE plugging the power cable into an AC wall outlet. Improper setting of VOLTAGE SELECTOR may cause damage to the unit and create a potential fire hazard.

The unit (rear)

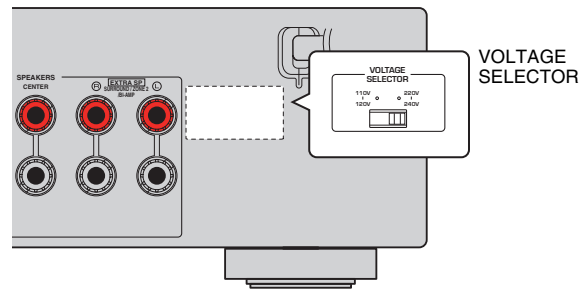

After all the connections are complete, plug in the power cable.

The unit (rear)

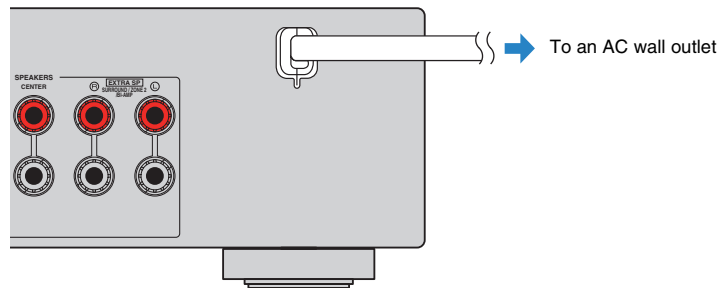

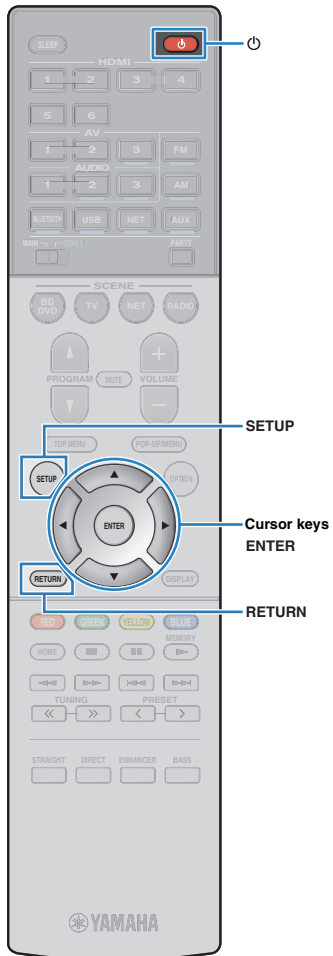

8 Selecting an on-screen menu language

Select the desired on-screen menu language.

1 Press ⏻ (receiver power) to turn on the unit.

2 Turn on the TV and switch the TV input to display video from the unit (HDMI OUT jack).



- Operations with TV screen are available only when your TV is connected to the unit via HDMI. If not, carry out operations while viewing the front display.
- If you turn on the unit for the first time, the message regarding the network setup appears. To continue the language setup, press RETURN.

3 Press SETUP.

4 Use the cursor keys to select “Language” and press ENTER.



5 Use the cursor keys to select the desired language.



6 To exit from the menu, press SETUP.



- The information on the front display is provided in English only.

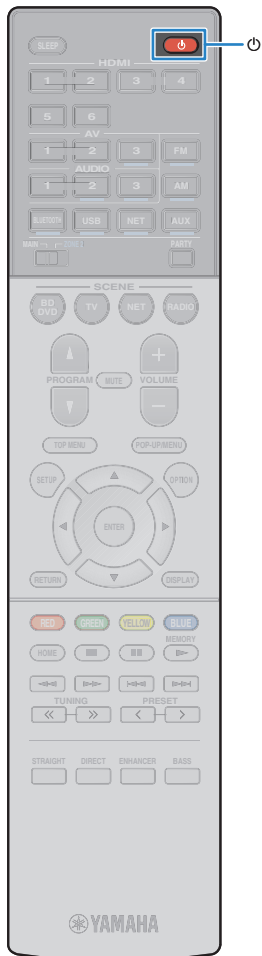

9 Optimizing the speaker settings automatically (YPAO)

The Yamaha Parametric room Acoustic Optimizer (YPAO) function detects speaker connections, measures the distances from them to your listening position(s), and then automatically optimizes the speaker settings, such as volume balance and acoustic parameters, to suit your room.



- Please note the following when using YPAO.
 - Use YPAO after connecting a TV and speakers to the unit.
 - During the measuring process, test tones are output at high volume. Ensure that the test tones do not frighten small children.
 - During the measuring process, you cannot adjust the volume.
 - During the measuring process, keep the room as quiet as possible.
 - Do not connect headphones.
 - Do not stand between the speakers and the YPAO microphone during the measurement process (about 3 minutes).

1 Press (receiver power) to turn on the unit.

2 Turn on the TV and switch the TV input to display video from the unit (HDMI OUT jack).



- Operations with TV screen are available only when your TV is connected to the unit via HDMI. If not, carry out operations while viewing the front display.

3 Turn on the subwoofer and set the volume to half. If the crossover frequency is adjustable, set it to maximum.

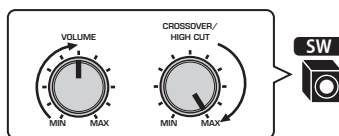

- When using bi-amp connection or Zone2 speakers, set "Power AMP Assign" (p.88) in the "Setup" menu to the appropriate setting before starting YPAO.
- When using the front 5.1-channel speaker (Virtual CINEMA FRONT) configuration (p.14), set "Virtual CINEMA FRONT" (p.89) in the "Setup" menu to "On" beforehand.

4 Place the YPAO microphone at your listening position and connect it to the YPAO MIC jack on the front panel.



- Place the YPAO microphone at your listening position (same height as your ears). We recommend the use of a tripod as a microphone stand. You can use the tripod screws to stabilize the microphone.

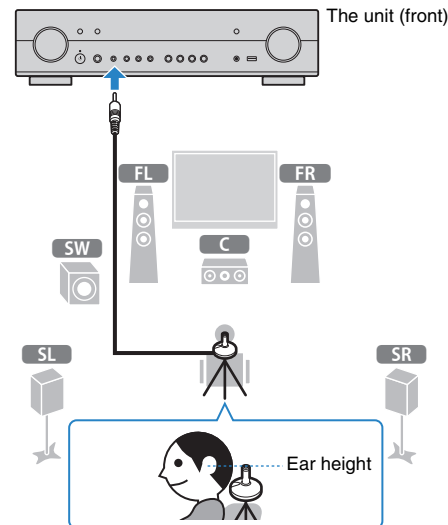

The following screen appears on the TV.

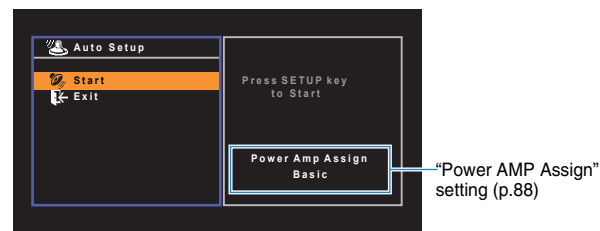

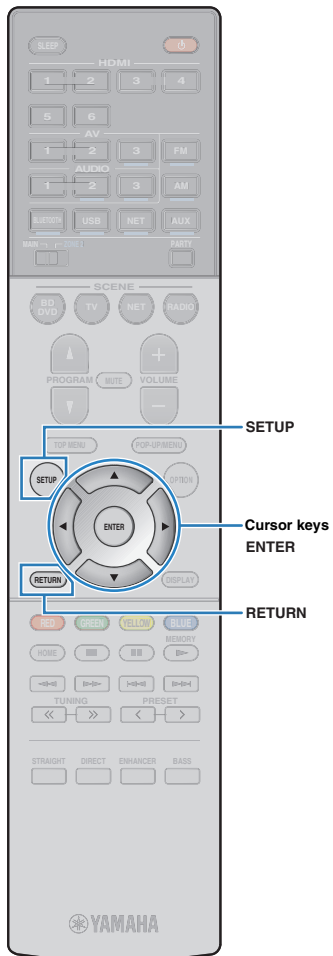

5 To start the measurement, use the cursor keys to select “Start” and press SETUP.

The measurement will start in 10 seconds. Press ENTER to start the measurement immediately.



- To stop the measurement temporarily, press RETURN and follow the procedure in “Error messages” (p.29).

The following screen appears on the TV when the measurement finishes.

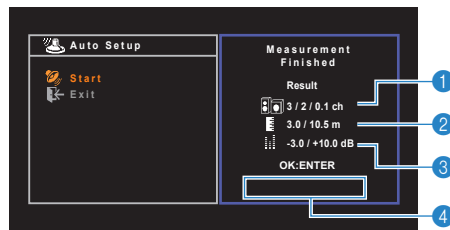

- 1 The number of speakers (front side/rear side/subwoofer)**
- 2 Speaker distance (nearest/farthest)**
- 3 Adjustment range of speaker output level**
- 4 Warning message (displayed only if a problem occurs)**



- If any error message (such as E-1) or warning message (such as W-1) appears, see “Error messages” (p.29) or “Warning messages” (p.30).



- A speaker with a problem is indicated by blinking of the speaker indicators in the front display.
- If multiple warnings are given (when operating with the front display), use the cursor keys (Δ/∇) to check the other warning messages.

6 Press ENTER after confirming the measurement result.

7 Use the cursor keys (\triangle/∇) to select “SAVE” and press ENTER.

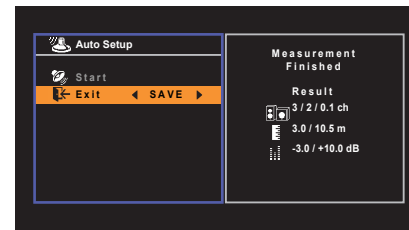

The adjusted speaker settings are applied.



- To finish the measurement without saving the result, select “CANCEL”.

8 Disconnect the YPAO microphone from the unit.

This completes optimization of the speaker settings.

Caution

- The YPAO microphone is sensitive to heat, so should not be placed anywhere where it could be exposed to direct sunlight or high temperatures (such as on top of AV equipment).

Error messages

If any error message is displayed during the measurement, resolve the problem and perform YPAO again.

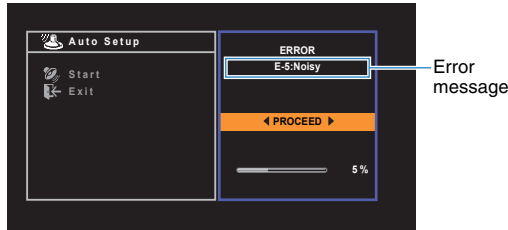

TV screen



Front display

Procedure to handle errors

- 1 Check the content of error message and press ENTER.
- 2 Use the cursor keys (</>) to select the desired operation.

To exit the YPAO measurement:

- ① Select "EXIT" and press ENTER.
- ② Use the cursor keys (△/▽) to select "Exit" and press ENTER.
- ③ Disconnect the YPAO microphone from the unit.

To retry the YPAO measurement from beginning:

Select "RETRY" and press ENTER.

To proceed with the current YPAO measurement (for E-5 and E-9 only):

Select "PROCEED" and press ENTER.

Error message	Cause	Remedy
E-1:No Front SP (E-1:NO FRNT SP)	Front speakers are not detected.	Exit YPAO, turn off the unit, and then check the speaker connections.
E-2:No Sur. SP (E-2:NO SUR SP)	One of the surround speakers cannot be detected.	
E-5:Noisy (E-5:NOISY)	The noise is too loud.	Keep the room quiet and retry YPAO. If you select "PROCEED", YPAO takes the measurement again and ignores any noise detected.
E-7:No MIC (E-7:NO MIC)	The YPAO microphone has been removed.	Connect the YPAO microphone to the YPAO MIC jack firmly and retry YPAO.
E-8:No Signal (E-8:NO SIGNAL)	The YPAO microphone cannot detect test tones.	Connect the YPAO microphone to the YPAO MIC jack firmly and retry YPAO. If this error occurs repeatedly, contact the nearest authorized Yamaha dealer or service center.
E-9:User Cancel (E-9:CANCEL)	The measurement has been canceled.	Retry or exit YPAO as necessary.
E-10:Internal Err. (E-10:INTERNAL)	An internal error has occurred.	Exit YPAO, and turn off and on the unit. If this error occurs repeatedly, contact the nearest authorized Yamaha dealer or service center.



- Texts in parentheses denote indicators on the front display.

Warning messages

If a warning message is displayed after the measurement, you can still save the measurement results by following on-screen instructions. However, we recommend you perform YPAO again in order to use the unit with the optimal speaker settings.

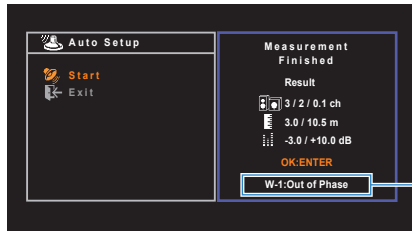

Warning message

TV screen

Problem speaker (blinks)



Front display

Warning message	Cause	Remedy
W-1: Out of Phase (W-1:PHASE)	A speaker cable may be connected with the reverse polarity (+/-).	<p>Check the cable connections (+/-) of the problem speaker.</p> <p>If the speaker is connected incorrectly: Turn off the unit, reconnect the speaker cable.</p> <p>If the speaker is connected correctly: Depending on the type of speakers or room environment, this message may appear even if the speakers are connected correctly. In this case, you can ignore the message.</p>
W-2: Over Distance (W-2:DISTANCE)	A speaker is placed more than 24 m (80 ft) from the listening position.	Exit YPAO, turn off the unit, and place the problem speaker within 24 m (80 ft) of the listening position.
W-3: Level Error (W-3:LEVEL)	There are significant volume differences between the speakers.	Check the usage environment and cable connections (+/-) of each speaker, and the volume of the subwoofer. If there is any problem, exit YPAO, turn off the unit, and then reconnect speaker cable or correct the speaker positions. We recommend using the same speakers or speakers with specifications that are as similar as possible.



- Texts in parentheses denote indicators on the front display.

Procedure to handle warnings

1 Check the content of warning message and press ENTER.

2 Use the cursor keys (</>) to select the desired operation.

To save the measurement results:

Select "SAVE" and press ENTER.

To discard the measurement result:

Select "CANCEL" and press ENTER.

3 Disconnect the YPAO microphone from the unit.

10 Connecting to a network wirelessly

Connect the unit to a wireless router (access point) or a mobile device by establishing a wireless connection.



- When you connect the unit to a router with a network cable, you need not do this procedure.

Selecting the connection method

Select a connection method according to your network environment.

■ Connecting with a wireless router (access point)

Connect the unit to a wireless router (access point).

You can enjoy Internet radio, AirPlay, or music files stored on media servers (PC/NAS) on the unit.

You can also use the application for smartphone / tablet “AV CONTROLLER” (p.7) to control the unit from mobiles devices or enjoy music files stored on mobiles devices on the unit.

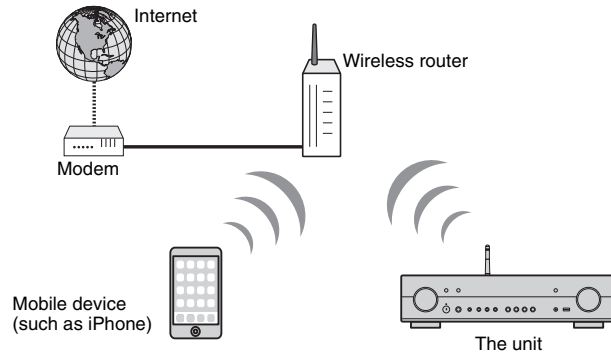

For details on connection, see “Connecting the unit to a wireless network” (p.32).



- You cannot use the wireless LAN connection simultaneously with the wired LAN connection (p.24) or Wireless Direct (p.39).
- If the unit and the wireless router (access point) are too far apart, the unit may not connect to a wireless router (access point). In such case, place them close to each other.

■ Connecting without a wireless router (access point)

Connect a mobile device to the unit directly.

You can use the application for smartphone / tablet “AV CONTROLLER” (p.7) to control the unit from mobiles devices or enjoy music files stored on mobiles devices on the unit.

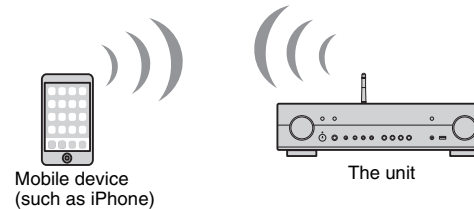

For details on connection, see “Connecting a mobile device to the unit directly (Wireless Direct)” (p.39).



- You cannot use Wireless Direct simultaneously with the wired LAN connection (p.24) or the wireless LAN connection (p.32).
- When Wireless Direct is enabled, the unit cannot connect to the Internet. Therefore, you cannot use any kind of Internet service such as Internet radio.
- Also the mobile device cannot connect to the Internet, so we recommend you disconnect the mobile device from the unit.

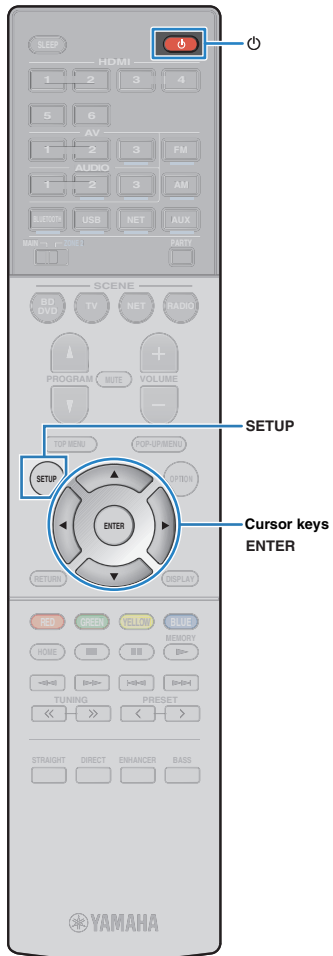

Connecting the unit to a wireless network

There are several methods to connect the unit to a wireless network.

Select a connection method according to your environment.

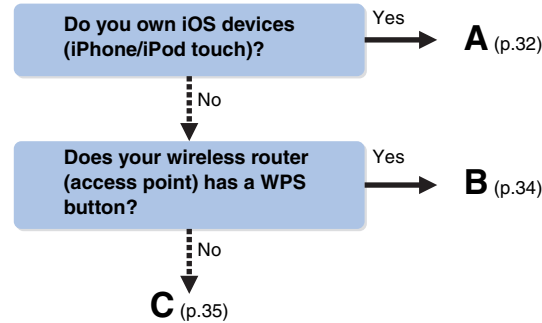

■ A: Sharing the iOS device setting

You can easily setup a wireless connection by applying the connection settings on iOS devices (iPhone/iPod touch).

Before proceeding, confirm that your iOS device is connected to a wireless router.

- 1 Press **⏻** (receiver power) to turn on the unit.
- 2 Turn on the TV and switch the TV input to display video from the unit (HDMI OUT jack).
 - ! Operations with TV screen are available only when your TV is connected to the unit via HDMI.
- 3 Press **SETUP**.
- 4 Use the cursor keys (**⬆**/**⬇**) to select “Network” and press **ENTER**.
- 5 Use the cursor keys (**⬆**/**⬇**) to select “Network Connection” and press **ENTER**.

- 6 Use the cursor keys (**⬅**/**➡**) to select “Wireless (Wi-Fi)” and press **ENTER**.

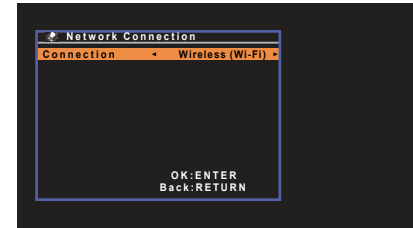

- 7 Use the cursor keys (**⬆**/**⬇**) to select “Share Wi-Fi Settings(iOS)” and press **ENTER**.

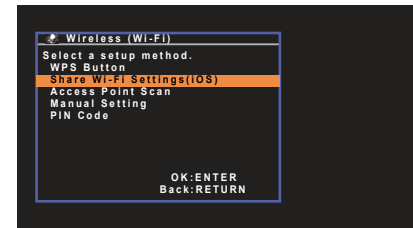

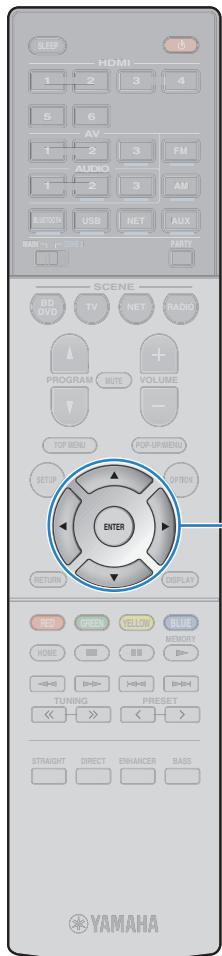

Cursor keys
ENTER

8 Use the cursor keys (Δ/∇) and ENTER to select the desired connection method.



The following connection methods are available.

Wireless (WAC)

You can apply the connection settings on the iOS device to the unit using a wireless connection. For details, see "Sharing the iOS device setting wirelessly". (You need iOS device with iOS 7 or later.)

USB Cable

You can apply the connection settings on the iOS device to the unit using a USB cable. For details, see "Sharing the iOS device setting using a USB cable". (You need iOS device with iOS 5 or later.)



- When you use wired network connection, Wireless (WAC) is not available.
- A wireless connection cannot be established using Wireless (WAC) if your wireless router (access point) uses WEP encryption. Try another connection method.

9 Press ENTER to proceed to the next screen.

Sharing the iOS device setting wirelessly

If you select "Wireless (WAC)" as the connection method, perform the network setting sharing operation on your iOS device. (The following procedure is a setup example for iOS 8.)

1 On the iOS device, select the unit as the AirPlay speaker in the Wi-Fi screen.

iOS (example of English version)

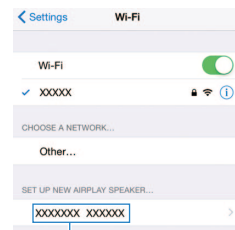

The name of the unit

2 Select the network (access point) of which you want to share the settings with the unit.

iOS (example of English version)

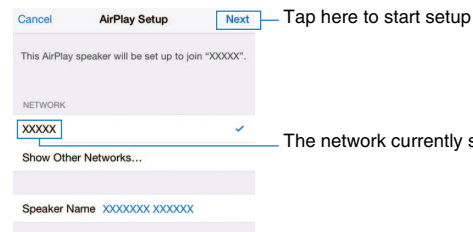

The network currently selected

When the sharing process finishes, the unit is automatically connected to the selected network (access point).

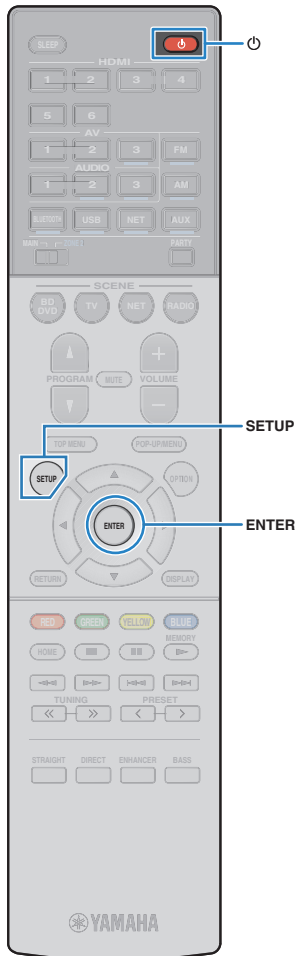

❑ **Sharing the iOS device setting using a USB cable**

If you select “USB Cable” as the connection method, follow the procedure below to share the iOS device setting with the unit.

- 1 Connect the iOS device to the USB jack, and disable the screen lock on the iOS device.**

The unit (front)

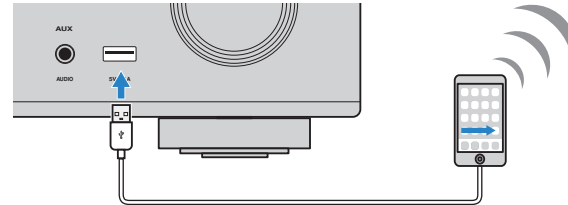

- 2 Press ENTER on the remote control.**
- 3 Tap “Allow” in the message appeared on the iOS device.**

When the connection process finishes, “Completed” appears on the TV screen.

- 4 To exit from the menu, press SETUP.**

■ **B: Using the WPS button configuration**

You can easily set up a wireless connection with one push of the WPS button.

- 1 Press  (receiver power) to turn on the unit.**
- 2 Hold down INFO (WPS) on the front panel for 3 seconds.**
“Press WPS button on Access Point” appears on the front display.
- 3 Push the WPS button on the wireless router (access point).**

When the connection process finishes, “Completed” appears on the front display.

If “Not connected” appears, repeat from step 1 or try another connection method.



- Depending on the model of the wireless router (access point), the unit may not connect to it. In this case, try connection with “Access Point Scan” or “Manual Setting” (p.35).



- You can use “WPS Button” (p.35) in the “Setup” menu to set up a wireless connection with the WPS button.

About WPS

WPS (Wi-Fi Protected Setup) is a standard established by the Wi-Fi Alliance, which allows easy establishment of a wireless home network.

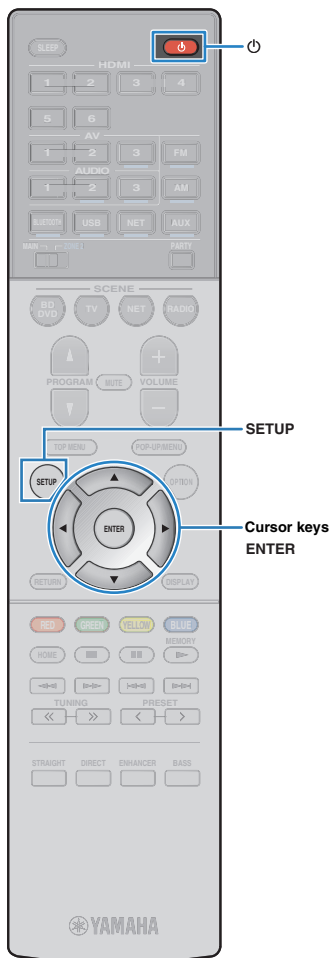

■ C: Using other connection methods

If your wireless router (access point) does not support WPS button configuration method, follow the procedure below to configure the wireless network settings.

1 Press **⏻** (receiver power) to turn on the unit.

2 Turn on the TV and switch the TV input to display video from the unit (HDMI OUT jack).



• Operations with TV screen are available only when your TV is connected to the unit via HDMI.

3 Press **SETUP**.

4 Use the cursor keys (Δ/∇) to select “Network” and press **ENTER**.

5 Use the cursor keys (Δ/∇) to select “Network Connection” and press **ENTER**.

6 Use the cursor keys ($\triangleleft/\triangleright$) to select “Wireless (Wi-Fi)” and press **ENTER**.

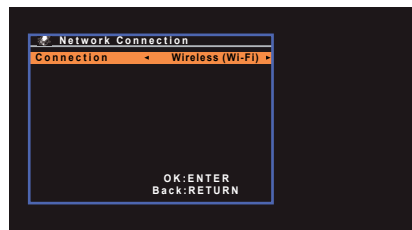

7 Use the cursor keys (Δ/∇) to select the desired connection method and press **ENTER**.

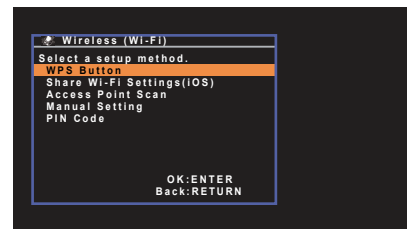

The following connection methods are available.

WPS Button	You can set up a wireless connection with the WPS button while viewing the TV screen. Follow the instructions displayed on the TV screen.
Share Wi-Fi Settings(iOS)	See “Sharing the iOS device setting” (p.32).
Access Point Scan	You can set up a wireless connection by searching for an access point. For details on settings, see “Searching for an access point” (p.36).
Manual Setting	You can setup a wireless connection by entering the required information (such as SSID) manually. For details on settings, see “Setting up the wireless connection manually” (p.37).
PIN Code	You can set up a wireless connection by entering the unit’s PIN code into the wireless router (access point). The method is available if the wireless router (access point) supports the WPS PIN code method. For details on settings, see “Using the WPS PIN code” (p.38).

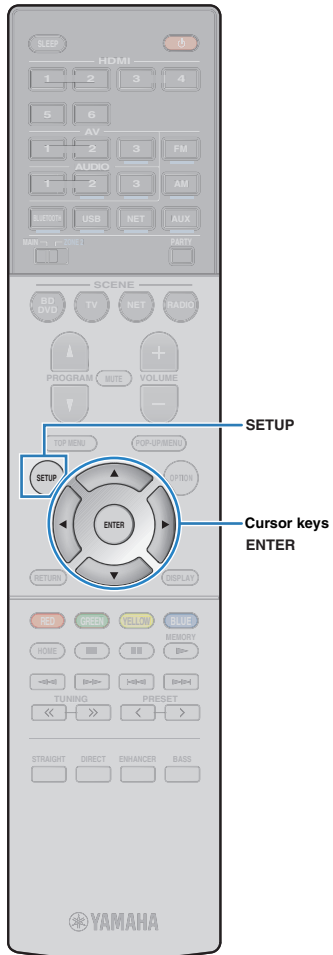

Searching for an access point

If you select “Access Point Scan” as the connection method, the unit starts searching for access points. After a while, the list of available access points appears on the TV screen.

1 Use the cursor keys (Δ/∇) to select the desired access point and press ENTER.

The wireless connection setting screen appears on the TV.

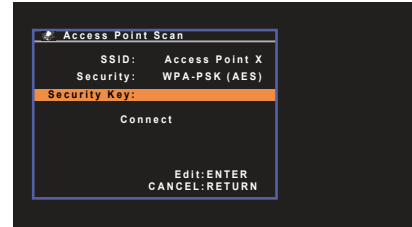

2 Press ENTER.

3 Use the cursor keys and ENTER to enter the security key.



Button functions

- [←]/[→]: Moves the cursor left and right.
- [Aa]: Switches the letter cases (upper/lower).
- [BKSP]: Deletes the character to the left of the selected one.
- [Space]: Enters a space.
- [DEL]: Deletes the selected character.

When finished entering the key, select “OK” to return to the previous screen.

4 Use the cursor keys (Δ/∇) to select “Connect” and press ENTER to start the connection process.

When the connection process finishes, “Completed” appears on the TV screen.

If “Not connected” appears, repeat from step 1 or try another connection method.

5 To exit from the menu, press SETUP.

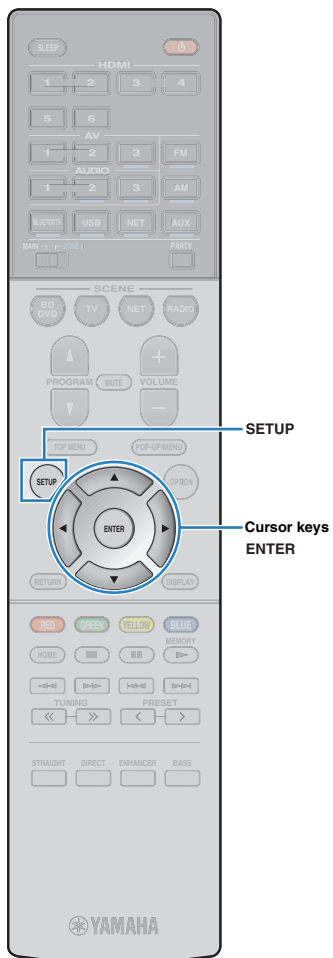

□ Setting up the wireless connection manually

If you select “Manual Setting” as the connection method, the wireless connection setting screen appears on the TV.

You need to setup the SSID (network name), encryption method and security key for your network.

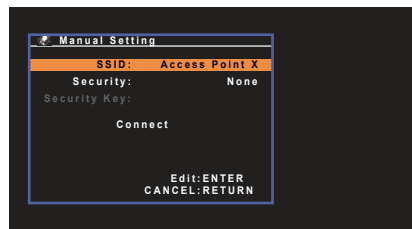

1 Use the cursor keys (Δ/∇) to select “SSID” and press ENTER.

2 Use the cursor keys and ENTER to enter the SSID of the access point.



When finished entering the key, select “OK” to return to the previous screen.

3 Use the cursor keys (Δ/∇) to select “Security” and the cursor keys (\leftarrow/\rightarrow) to select the encryption method.

Choices

None, WEP, WPA-PSK (AES), Mixed Mode



- If you select “None”, the connection may be insecure since the communication is not encrypted.

4 Use the cursor keys (Δ/∇) to select “Security Key” and press ENTER.



- If you select “None” in step 3, this item is not available.

5 Use the cursor keys and ENTER to enter the security key.

If you select “WEP” in step 3, enter either 5 or 13 character string, or 10 or 26 hexadecimal digits.

If you select the method other than “WEP” in step 3, enter either 8 to 63 character string, or 64 hexadecimal digits.



When finished entering the key, select “OK” to return to the previous screen.

6 Use the cursor keys (Δ/∇) to select “Connect” and press ENTER to start the connection process.

When the connection process finishes, “Completed” appears on the TV screen.

If “Not connected” appears, check that all the information is entered correctly, and repeat from step 1.

7 To exit from the menu, press SETUP.

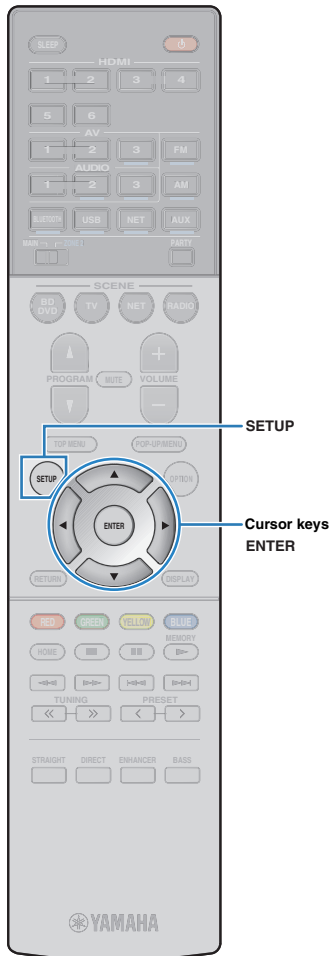

Using the WPS PIN code

If you select “PIN Code” as the connection method, the list of available access points appears on the TV screen.

1 Use the cursor keys (Δ/▽) to select the desired access point and press ENTER.

The PIN code of the unit appears on the TV screen.



2 Enter the unit’s PIN code into the wireless router (access point).

For details on settings, refer to the instruction manual of the wireless router (access point).

3 Press ENTER to start the connection process.

When the connection process finishes, “Completed” appears on the TV screen.

If “Not connected” appears, repeat from step 1 or try another connection method.

4 To exit from the menu, press SETUP.

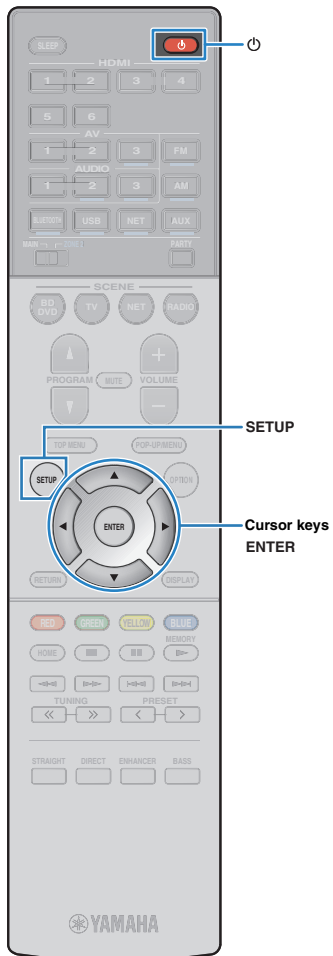

Connecting a mobile device to the unit directly (Wireless Direct)

Follow the procedure below to connect a mobile device to the unit directly.



- Wireless Direct connection may be insecure since the communication is not strongly encrypted. The unit may operate by playback operation on wireless devices connected to the unit without permission.

- 1 Press **⏻** (receiver power) to turn on the unit.
- 2 Turn on the TV and switch the TV input to display video from the unit (HDMI OUT jack).
- 3 Press **SETUP**.
- 4 Use the cursor keys (**△/▽**) to select “Network” and press **ENTER**.
- 5 Use the cursor keys (**△/▽**) to select “Network Connection” and press **ENTER**.
- 6 Use the cursor keys (**◀/▶**) to select “Wireless Direct” and press **ENTER**.

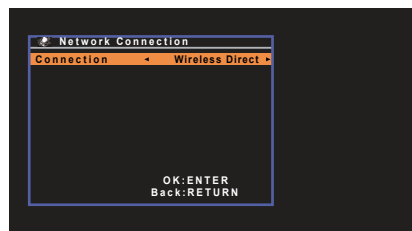

- 7 Use the cursor keys (**△/▽**) to select “Security” and the cursor keys (**◀/▶**) to select the encryption method.

Choices

None, WPA2-PSK (AES)



- If you select “None”, the connection may be insecure since the communication is not encrypted.

- 8 Use the cursor keys (**△/▽**) to select “Security Key” and press **ENTER**.



- If you select “None” in step 7, this item is not available.

- 9 Use the cursor keys and **ENTER** to enter the security key.

Enter either 8 to 63 character string, or 64 hexadecimal digits.

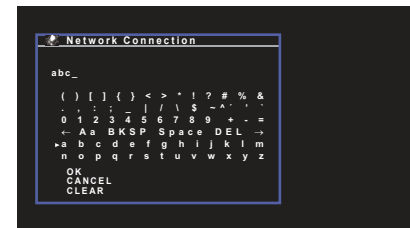

When finished entering the key, select “OK” to return to the previous screen.



- Before proceeding to the next step, record the following information. These information will be needed to configure the Wi-Fi setting of a mobile device.
 - SSID displayed on the TV screen
 - Security key you have just entered

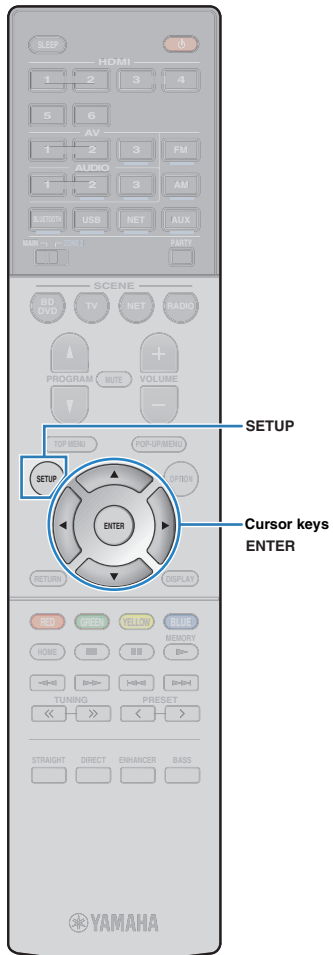

10 Use the cursor keys (Δ/∇) to select “Save” and press ENTER to save the setting.

This completes the settings and “Completed” appears on the TV screen.

Next, configure the Wi-Fi settings of a mobile device.

11 Configure the Wi-Fi settings of a mobile device.

For details on settings of your mobile device, refer to the instruction manual of the mobile device.

- ① Enable the Wi-Fi function on the mobile device.
- ② Select the SSID displayed in step 9 from the list of available access points.
- ③ When you are prompted for a password, enter the security key displayed in step 9.

12 To exit from the menu, press SETUP.

PLAYBACK

Basic playback procedure

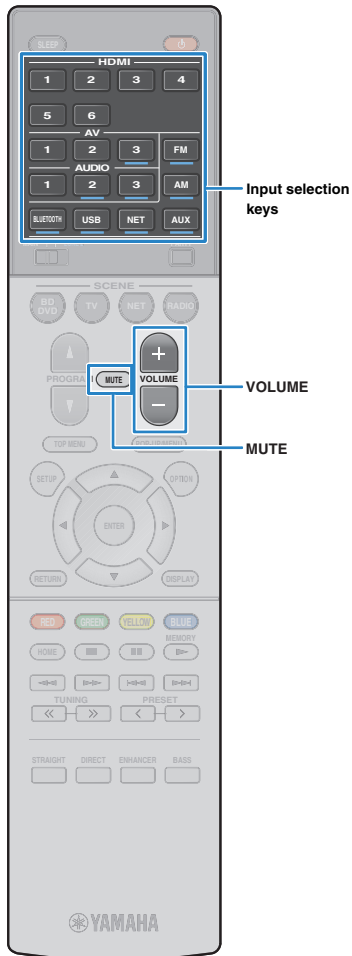

- 1 Turn on the external devices (such as a TV or BD/DVD player) connected to the unit.**
- 2 Use the input selection keys to select an input source.**
- 3 Start playback on the external device or select a radio station.**

Refer to the instruction manual for the external device.
For details on the following operations, see the corresponding pages.

 - Listening to FM/AM radio (RX-S601) (p.48)
 - Listening to DAB radio (RX-S601D) (p.52)
 - Listening to FM radio (RX-S601D) (p.56)
 - Playing back iPod music (p.61)
 - Playing back music via BLUETOOTH (p.60)
 - Playing back music stored on a USB storage device (p.66)
 - Playing back music stored on media servers (PCs/NAS) (p.69)
 - Listening to Internet radio (p.72)
 - Playing back music with AirPlay (p.64)
- 4 Press VOLUME to adjust the volume.**



- To mute the audio output, press MUTE. Press MUTE again to unmute.
- To adjust the treble/bass settings, use the "Option" menu (p.81).

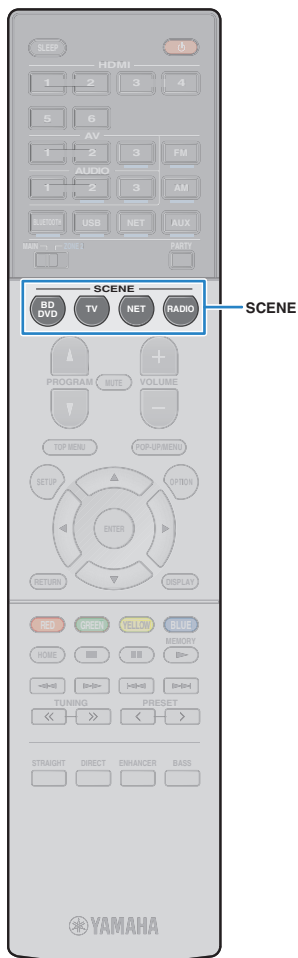

Selecting the input source and favorite settings with one touch (SCENE)

The SCENE function allows you to select the assigned input source, sound program, and Compressed Music Enhancer on/off with just one touch.

Selecting a registered scene

1 Press SCENE.

The input source and settings registered to the corresponding scene are selected. The unit turns on automatically when it is in standby mode.

By default, the following settings are registered for each scene.

SCENE	BD DVD	TV	NET	RADIO
Input	HDMI 1	AV 1	NET RADIO	TUNER
Sound program	Sci-Fi	STRAIGHT	5ch Stereo	5ch Stereo
Compressed Music Enhancer	Off	On	On	On
SCENE link playback	On	On	Off	Off



- The SCENE link playback function allows you to automatically turn on the TV or start playback of an external device connected to the unit via HDMI, in conjunction with a scene selection. To enable SCENE link playback, set "SCENE" (p.92) in the "Setup" menu to "On".

Configuring scene assignments

- Perform the following operations to prepare the settings you want to assign to a scene.
 - Select an input source (p.41)
 - Select a sound program (p.43)
 - Enable/disable Compressed Music Enhancer (p.47)
- Hold down the desired SCENE key until "SET Complete" appears on the front display.



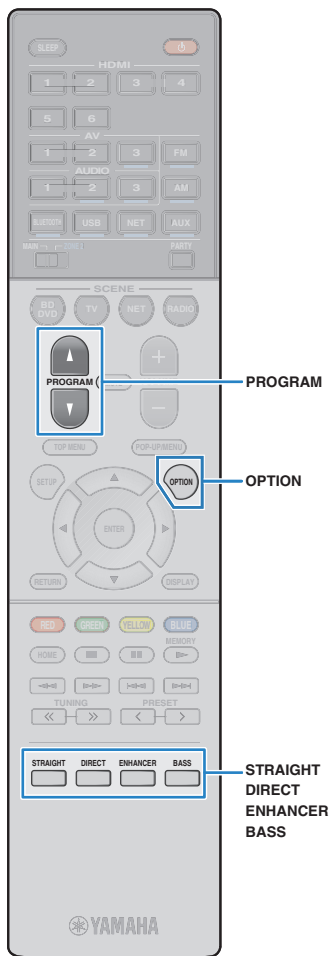

Selecting the sound mode

The unit is equipped with a variety of sound programs and surround decoders that allow you to enjoy playback sources with your favorite sound mode (such as sound field effect or stereo playback).

I want to enjoy viewing video sources such as movies, TV programs, or games.

- Select a sound program suitable for each video source by pressing PROGRAM repeatedly (p.44).

I want to enjoy listening to music sources or stereo playback.

- Select a sound program suitable for music or stereo playback by pressing PROGRAM repeatedly (p.45).

I want to enjoy multichannel playback from 2-channel sources.

- Select a surround decoder in the "Option" menu (p.80).

I want to enjoy unprocessed sounds in original channels.

- Switch to the straight decode mode by pressing STRAIGHT (p.46).

I want to enjoy pure high fidelity sounds.

- Enable the direct playback mode by pressing DIRECT (p.47).

This mode reduces the electrical noise from other circuitry to allow you to enjoy Hi-Fi sound quality.

I want to enjoy enhanced bass sounds.

- Enable Extra Bass by pressing BASS (p.47).

I want to enjoy listening to compressed music.

- Enable Compressed Music Enhancer by pressing ENHANCER (p.47).

This mode lets you enjoy compressed music stored on a BLUETOOTH device or USB storage device with additional depth and breadth (p.47).



- The sound mode can be applied separately to each input source.
- When you play back audio signals with a sampling rate of higher than 96 kHz, the straight decode mode (p.46) is automatically selected.
- You can check which speakers are currently outputting sound by looking at the speaker indicators on the unit's front panel (p.9).

Enjoying stereoscopic sound fields (CINEMA DSP 3D)



The unit is equipped with a variety of sound programs that utilize Yamaha's original DSP technology (CINEMA DSP 3D). It allows you to easily create sound fields like actual movie theaters or concert halls in your room and enjoy natural stereoscopic sound fields.

Sound program category

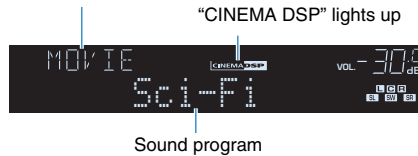

- You can adjust the sound field effect level in "DSP Level" (p.81) in the "Option" menu.
- To use the conventional CINEMA DSP, set "CINEMA DSP 3D Mode" (p.93) in the "Setup" menu to "Off".

■ Sound programs suitable for movies (MOVIE)

The following sound programs are optimized for viewing video sources, such as movies, TV programs, and games.

Standard	This program creates a sound field that emphasizes the surround feeling without disturbing the original acoustic positioning of multichannel audio, such as Dolby Digital and DTS. Its design is based on the concept of the ideal movie theater, in which the audience is surrounded by beautiful reverberations from the left, right, and rear.
Spectacle	This program delivers the scale and grandeur of spectacular movie productions. It delivers an expansive sound space to match the cinemascope wide-screen, and boasts a broad dynamic range, providing everything from small delicate sounds to powerful loud booms.
Sci-Fi	This program clearly reproduces the finely elaborated sound design of the latest Sci-Fi and SFX movies. You can enjoy a variety of cinematographically created virtual spaces reproduced with clear separation between dialogue, sound effects, and background music.
Adventure	This program is ideal for reproducing the sound design of action and adventure movies precisely. The sound field restrains reverberations, but puts emphasis on reproducing a sensation of expansiveness on both sides, powerful space expanded widely to the left and right. The restrained depth creates a clear and powerful space, while also maintaining the articulation of the sounds and the separation of the channels.

Drama	This program features stable reverberations that match a wide range of movie genres, from serious dramas to musicals and comedies. The reverberations are modest, but suitably stereophonic. The sound effects and background music are reproduced with a gentle echo that does not impinge on the articulation of the dialogue. You'll never get tired listening for long periods.
Mono Movie	This program reproduces monaural video sources, such as classic movies, in an atmosphere of a good old movie theater. The program creates a pleasant space with depth, by adding breadth and the appropriate reverberation to the original audio.
Sports	This program allows listeners to enjoy the rich vividness of sport broadcasts and light entertainment programs. In sports broadcasts, the commentators' voices are positioned clearly at the center, while the atmosphere inside the stadium is realistically conveyed by the peripheral delivery of the sounds of the fans in a suitable space.
Action Game	This program is suitable for action games, such as car racing and fighting games. The reality of, and emphasis on, various effects makes the player feel like they are right in the middle of the action, allowing for greater concentration. Use this program in combination with Compressed Music Enhancer for a more dynamic and strong sound field.
Roleplaying Game	This program is suitable for role-playing and adventure games. This program adds depth to the sound field for natural and realistic reproduction of background music, special effects, and dialogue from a wide variety of scenes. Use this program in combination with Compressed Music Enhancer for a clearer and more spatial sound field.

■ Sound programs suitable for music (MUSIC)

The following sound programs are optimized for listening to music sources.

Hall in Munich	This program simulates a Munich concert hall with approximately 2,500 seats that uses stylish wood for the interior finishing. Fine, beautiful reverberations spread richly, creating a calming atmosphere. The listener's virtual seat is at the center left of the arena.
Hall in Vienna	This program simulates a 1700-seat, middle-sized concert hall with a shoebox shape that is traditional in Vienna. Pillars and ornate carvings create extremely complex reverberations from all around the audience, producing a very full, rich sound.
Chamber	This program creates a relatively wide space with a high ceiling, like an audience hall in a palace. It offers pleasant reverberations that are suitable for courtly music and chamber music.
Cellar Club	This program simulates an intimate concert venue with a low ceiling and homey atmosphere. A realistic, live sound field delivers powerful sounds that make you feel as if you are sitting in the front row in front of a small stage.
The Roxy Theatre	This program creates the sound field of a 460-seat rock music concert venue in Los Angeles. The listener's virtual seat is at the center left of the hall.
The Bottom Line	This program creates the sound field at stage front in The Bottom Line, a famous New York jazz club once. The floor can seat 300 people to the left and right in a sound field offering real and vibrant sound.
Music Video	This program allows you to enjoy videos of pop, rock, and jazz concerts, as if you were there yourself. Immerse yourself in the hot concert atmosphere thanks to the vividness of the singers and solos on stage, a presence sound field that emphasizes the beat of rhythm instruments, and a surround sound field that reproduces the space of a big live hall.

■ Sound programs suitable for stereo playback (STEREO)

You can select stereo playback.

2ch Stereo	Use this program to mix down multichannel sources to 2 channels. When multichannel signals are input, they are down mixed to 2 channels and output from the front speakers (this program does not utilize CINEMA DSP).
5ch Stereo	Use this program to output sound from all speakers. When you play back multichannel sources, the unit mixes down the source to 2 channels, and then outputs the sound from all speakers. This program creates a larger sound field and is ideal for background music at parties.



- CINEMA DSP 3D (p.44) and Virtual CINEMA DSP (p.45) do not work when "2ch Stereo" or "5ch Stereo" is selected.

■ Enjoying sound field effects without surround speakers (Virtual CINEMA DSP)

If you select one of the sound programs (except 2ch Stereo and 5ch Stereo) when no surround speakers are connected, the unit automatically creates the surround sound field using the front-side speakers.

■ Enjoying surround sound with 5 speakers placed in front (Virtual CINEMA FRONT)

You can enjoy the surround sound even when the surround speakers are placed in front.

■ Enjoying surround sound with headphones (SILENT CINEMA)

SILENT™
CINEMA

You can enjoy surround or sound field effects, like a multichannel speaker system, with stereo headphones by connecting the headphones to the PHONES jack and selecting a sound program or a surround decoder.

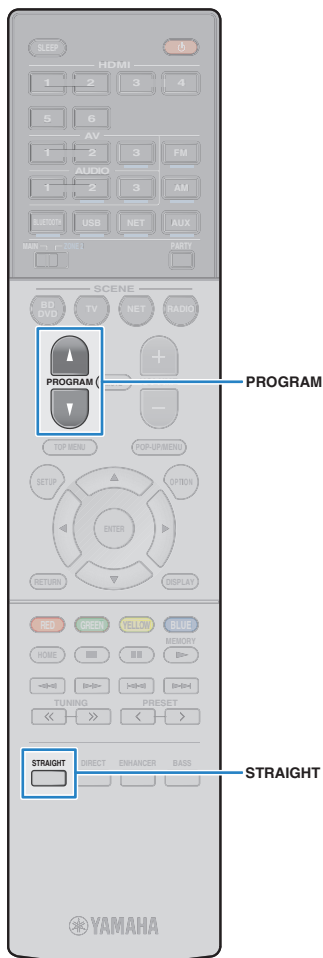

Enjoying unprocessed playback

You can play back input sources without any sound field effect processing.

■ Playing back in original channels (straight decode)

When the straight decode mode is enabled, the unit produces stereo sound from the front speakers for 2-channel sources such as CDs, and produces unprocessed multichannel sounds for multichannel sources.

1 Press STRAIGHT.

Each time you press the key, the straight decode mode is enabled or disabled.



■ Playing back 2-channel sources in multichannel (surround decoder)

The surround decoder enables unprocessed multichannel playback from 2-channel sources. When a multichannel source is input, it works the same way as the straight decode mode.

For details on each decoder see “Glossary” (p.118).

1 Press PROGRAM repeatedly to select a surround decoder.

The previously selected surround decoder is selected. You can change the surround decoder in “Sur.Decode” (p.80) in the “Option” menu.

“SUR. DECODE” appears



Dolby Pro Logic	Uses the Dolby Pro Logic decoder suitable for all sources.
Dolby PLII Movie	Use the Dolby Pro Logic II decoder suitable for movies.
Dolby PLII Music	Use the Dolby Pro Logic II decoder suitable for music.
Dolby PLII Game	Use the Dolby Pro Logic II decoder suitable for games.
Neo: 6 Cinema	Uses the DTS Neo: 6 decoder suitable for movies.
Neo: 6 Music	Uses the DTS Neo: 6 decoder suitable for music.



- You can adjust the surround decoder parameters in “DSP Parameter” (p.93) in the “Setup” menu.



Enjoying pure high fidelity sound (direct playback)

When the direct playback mode is enabled, the unit plays back the selected source with the least circuitry in order to reduce the electrical noise from other circuitry (such as the front display). It allows you to enjoy Hi-Fi sound quality.

1 Press DIRECT.

Each time you press the key, the direct playback mode is enabled or disabled.



- When the direct playback mode is enabled, the following functions are not available.
 - Selecting sound programs
 - Adjusting the tone control
 - Operating the on-screen and “Option” menus
 - Viewing information on the front display (when not in operation)

Enhancing the bass (Extra Bass)

Extra Bass allows you to enjoy enhanced bass sounds, regardless of the size of the front speakers and the presence or absence of the subwoofer.

1 Press BASS.

Each time you press the key, Extra Bass is enabled or disabled.



- You can also use “Extra Bass” (p.89) in the “Setup” menu to enable/disable Extra Bass.

Enjoying compressed music with enhanced sound (Compressed Music Enhancer)

compressed music ENHANCER

Compressed Music Enhancer adds depth and breadth to the sound, allowing you to enjoy a dynamic sound close to the original sound before it was compressed. This function can be used along with any other sound modes.

1 Press ENHANCER.

Each time you press the key, Compressed Music Enhancer is enabled or disabled.

“ENHANCER” lights up



- Compressed Music Enhancer does not work on the following audio sources.
 - Signals whose sampling rate is over 48 kHz
 - High-definition streaming audio



- You can also use “Enhancer” (p.81) in the “Option” menu to enable/disable Compressed Music Enhancer.

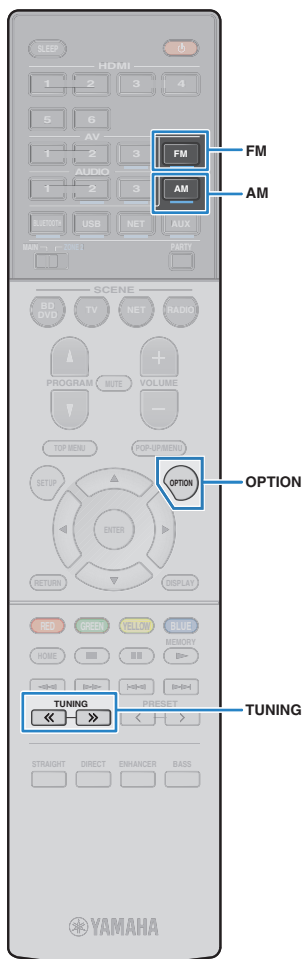

Listening to FM/AM radio (RX-S601)

You can tune into a radio station by specifying its frequency or selecting from registered radio stations.



- The radio frequencies differ depending on the country or region where the unit is being used. The explanation of this section uses a display with frequencies used in U.K. and Europe models.
- If you cannot obtain good reception on the radio, adjust the direction of the FM/AM antennas.

Setting the frequency steps

(Asia and General models only)

At the factory, the frequency step setting is set to 50 kHz for FM and 9 kHz for AM. Depending on your country or region, set the frequency steps to 100 kHz for FM and 10 kHz for AM.

- 1 Set the unit to standby mode.
- 2 When holding down **STRAIGHT** on the front panel, press **⏻** (power).

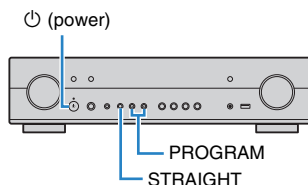

- 3 Press **PROGRAM** repeatedly to select “TU”.



- 4 Press **STRAIGHT** to select “FM100/AM10”.

- 5 Press **⏻** (power) to set the unit to standby mode and turn it on again.

Selecting a frequency for reception

- 1 Press **FM** or **AM** to select a band.

“TUNER” is selected as the input source and then the frequency currently selected is displayed.



- 2 Press **TUNING** repeatedly to set a frequency.

Hold down the key for about a second to search stations automatically.



“TUNED” lights up when a signal is received from a radio station.

“STEREO” also lights up when a stereo signal is received.



- You can switch between “Stereo” (stereo) and “Mono” (monaural) for FM radio reception from “FM Mode” (p.80) in the “Option” menu. When the signal reception for an FM radio station is unstable, switching to monaural may improve it.
- You can watch videos input from external devices while listening to radio by selecting the video input jack in “Video Out” (p.83) in the “Option” menu.

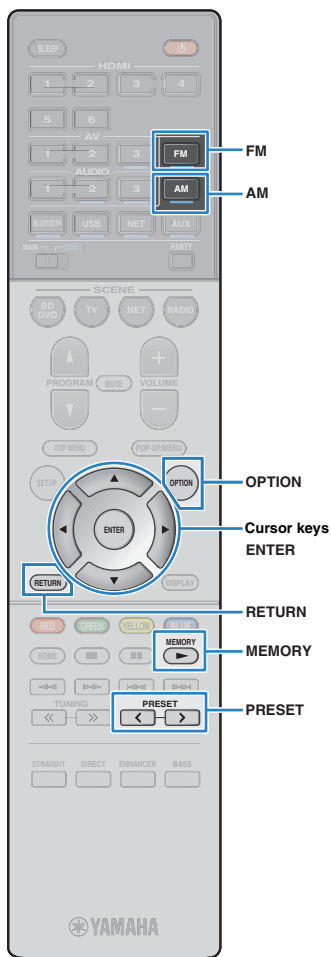

Registering favorite radio stations (presets)

You can register up to 40 radio stations as presets. Once you have registered stations, you can easily tune into them by selecting their preset numbers.

■ Registering radio stations automatically (Auto Preset)

Automatically register FM radio stations with strong signals (up to 40 stations).



- To register AM radio stations, follow “Registering a radio station manually”.
- (U.K. and Europe models only)
Only Radio Data System broadcasting stations are stored automatically by the Auto Preset function.

1 Press FM or AM to select “TUNER” as the input source.

2 Press OPTION.

3 Use the cursor keys to select “Auto Preset”.



4 To start the Auto Preset process, press ENTER.

The registration will start in 5 seconds. Press ENTER again to start the registration immediately.

“SEARCH” appears during Auto Preset



Preset number from which to start the registration



- To specify the preset number from which to start the registration, press PRESET or cursor keys (Δ/∇) to select a preset number within 5 seconds after step 4 (while “READY” is displayed) and then press ENTER (or just wait for 5 seconds).
- To cancel the Auto Preset process, press RETURN.

When the Auto Preset process finishes, “FINISH” appears and the “Option” menu closes automatically.



■ Registering a radio station manually

Select a radio station manually and register it to a preset number.

1 Follow “Selecting a frequency for reception” (p.48) to tune into the desired radio station.

2 Hold down MEMORY for more than 2 seconds.

The first time that you do register a station, the selected radio station will be registered to the preset number “01”. Thereafter, each radio station you select will be registered to the next empty (unused) preset number after the most recently registered number.



Preset number



- To select a preset number for registering, press MEMORY once after tuning into the desired radio station, press PRESET to select a preset number, and then press MEMORY again.



“Empty” (not in use) or the frequency currently registered

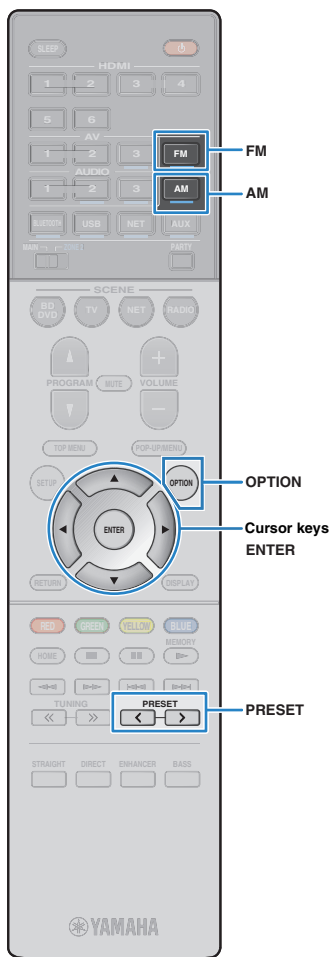

■ Selecting a preset station

Tune into a registered radio station by selecting its preset number.

- 1 Press FM or AM to select “TUNER” as the input source.
- 2 Press PRESET repeatedly to select the desired radio station.



- “No Presets” appears when no radio stations are registered.

■ Clearing preset stations

Clear radio stations registered to the preset numbers.

- 1 Press FM or AM to select “TUNER” as the input source.
- 2 Press OPTION.
- 3 Use the cursor keys to select “Clear Preset” and press ENTER.
- 4 Use the cursor keys (Δ/∇) to select a preset station to be cleared and press ENTER.



Preset station to be cleared

If the preset station is cleared, “Cleared” appears and then the next in-use preset number is displayed.



- 5 Repeat step 4 until all desired preset stations are cleared.
- 6 To exit from the menu, press OPTION.

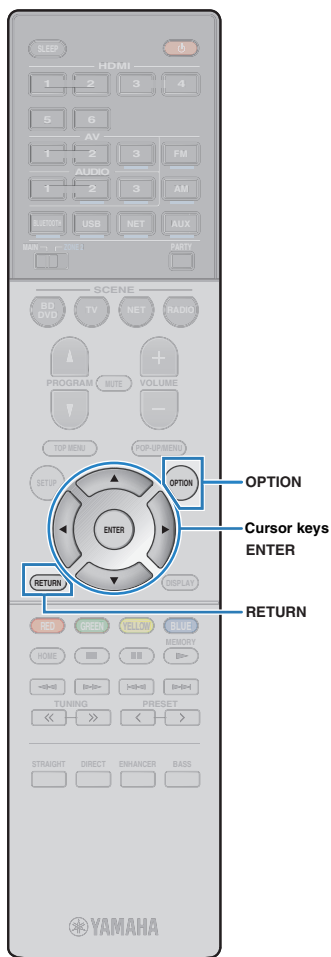

Radio Data System tuning

(U.K. and Europe models only)

Radio Data System is a data transmission system used by FM stations in many countries. The unit can receive various types of Radio Data System data, such as “Program Service”, “Program Type”, “Radio Text” and “Clock Time”, when it is tuned into a Radio Data System broadcasting station.

■ Displaying the Radio Data System information

1 Tune into the desired Radio Data System broadcasting station.



- We recommend using “Auto Preset” to tune into the Radio Data System broadcasting stations (p.49).

2 Press INFO (WPS) on the front panel.

Each time you press the key, the displayed item changes.



Item name

About 3 seconds later, the corresponding information for the displayed item appears.



Information

Program Service	Program service name
Program Type	Current program type
Radio Text	Information on the current program
Clock Time	Current time
DSP Program	Sound mode name
Audio Decoder	Decoder name
Frequency	Frequency



- “Program Service”, “Program Type”, “Radio Text”, and “Clock Time” are not displayed if the radio station does not provide the Radio Data System service.

■ Receiving traffic information automatically

When “TUNER” is selected as the input source, the unit automatically receives traffic information. To enable this function, follow the procedure below to set the traffic information station.

1 When “TUNER” is selected as the input source, press OPTION.

2 Use the cursor keys to select “Traffic Program” (TrafficProgram) and press ENTER.

The traffic information station search will start in 5 seconds. Press ENTER again to start the search immediately.



- To search upward/downward from the current frequency, press the cursor keys (Δ/∇) while “READY” is displayed.
- To cancel the search, press RETURN.
- Texts in parentheses denote indicators on the front display.

The following screen appears for about 3 seconds when the search finishes.



Traffic information station (frequency)



- “TP Not Found” appears for about 3 seconds when no traffic information stations are found.

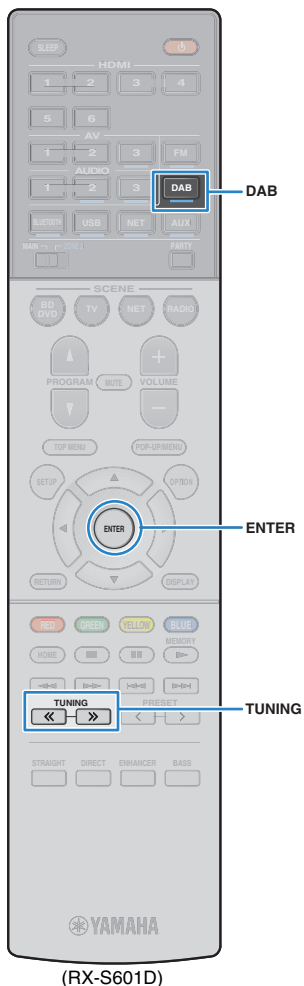

(RX-S601D)

Listening to DAB radio (RX-S601D)

DAB (Digital Audio Broadcasting) uses digital signals for clearer sound and more stable reception compared to analog signals. The unit can also receive DAB+ (an upgraded version of DAB) that allows for more stations using MPEG-4 audio codec (AAC+), which has a more efficient transmission method.



- The unit supports Band III (174 to 240 MHz) only.
- Be sure to check the DAB coverage in your area in that not all areas are currently being covered. For a list of nationwide DAB statuses and worldwide DAB frequencies, check WorldDMB online at <http://www.worlddab.org/>.



- For details on the antenna connection, see "Connecting the radio antennas" (p.23).

Preparing the DAB tuning

Before tuning into DAB radio stations, follow the procedure below to perform an initial scan.

1 Press DAB to select the DAB band.

The following message appears on the front panel if you have not performed an initial scan yet.



2 Press ENTER to start an initial scan.



When the initial scan finishes, the unit automatically tunes into the first DAB radio station as stored in station order.



- If no DAB radio stations are found by an initial scan, the message in Step 1 appears again. Press ENTER to start an initial scan again.
- You can check reception strength of each DAB channel label (p.55).
- To perform an initial scan again after some DAB radio stations are stored, select "Init Scan" (p.81) in the "Option" menu. If you perform an initial scan again, the DAB radio stations currently registered to the preset numbers will be cleared.

Selecting a DAB radio station for reception

You can select a DAB radio station from the stations stored by the initial scan.

1 Press DAB to select the DAB band.

2 Press TUNING repeatedly to select a DAB radio station.



- "Off Air" appears when the selected DAB radio station is currently not available.
- When the unit is receiving a secondary station, "2" appears next to "DAB".

Secondary station



- You can watch videos input from external devices while listening to radio by selecting the video input jack in "Video Out" (p.83) in the "Option" menu.



(RX-S601D)

Registering favorite DAB radio stations (presets)

You can register up to 40 DAB radio stations as presets. Once you have registered stations, you can easily tune into them by selecting their preset numbers.



- You can register up to 40 favorite radio stations each for DAB and FM bands.

■ Registering a DAB radio station as presets

Select a DAB radio station and register it to a preset number.

1 Follow “Selecting a DAB radio station for reception” (p.52) to tune into the desired DAB radio station.

2 Hold down MEMORY for more than 2 seconds.

The first time that you do register a station, the selected radio station will be registered to the preset number “01”. Thereafter, each radio station you select will be registered to the next empty (unused) preset number after the most recently registered number.



Preset number



- To select a preset number for registering, press MEMORY once after tuning into the desired DAB radio station, press PRESET to select a preset number, and then press MEMORY again.



“Empty” (not in use) or “Overwrite?” (in use)

■ Selecting a preset DAB radio station

Tune into a registered DAB radio station by selecting its preset number.

- 1 Press DAB to select the DAB band.**
- 2 Press PRESET repeatedly to select the desired DAB radio station.**



- “No Presets” appears when no DAB radio stations are registered.

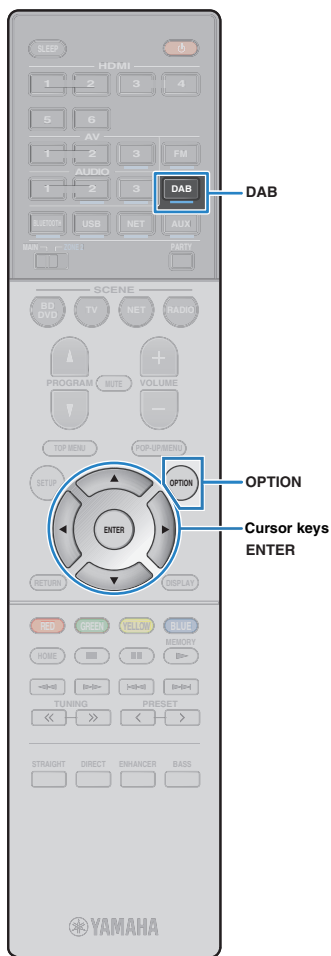

(RX-S601D)

■ Clearing preset DAB radio stations

Clear DAB radio stations registered to the preset numbers.

- 1 Press **DAB** to select the DAB band.
- 2 Press **OPTION**.
- 3 Use the cursor keys to select “Clear Preset” and press **ENTER**.



- 4 Use the cursor keys (Δ/∇) to select a preset station to be cleared and press **ENTER**.



Preset station to be cleared

If the preset station is cleared, “Cleared” appears and then the next in-use preset number is displayed.



- 5 Repeat step 4 until all desired preset stations are cleared.
- 6 To exit from the menu, press **OPTION**.

Displaying the DAB information

The unit can receive various types of DAB information when it is tuned into a DAB radio station.

- 1 Tune into the desired DAB radio station.
- 2 Press **INFO (WPS)** on the front panel.

Each time you press the key, the displayed item changes.



Item name

About 3 seconds later, the corresponding information for the displayed item appears.



Information

Service Label	Station name
DLS (Dynamic Label Segment)	Information on the current station
Ensemble Label	Ensemble name
Program Type	Station genre
Date And Time	Current date and time
Audio Mode	Audio mode (monaural/stereo) and bit rate
CH Label/Freq.	Channel label and frequency
Signal Quality	Signal reception quality (0 [none] to 100 [best])
DSP Program	Sound mode name
Audio Decoder	Decoder name



- Some information may not be available depending on the selected DAB radio station.

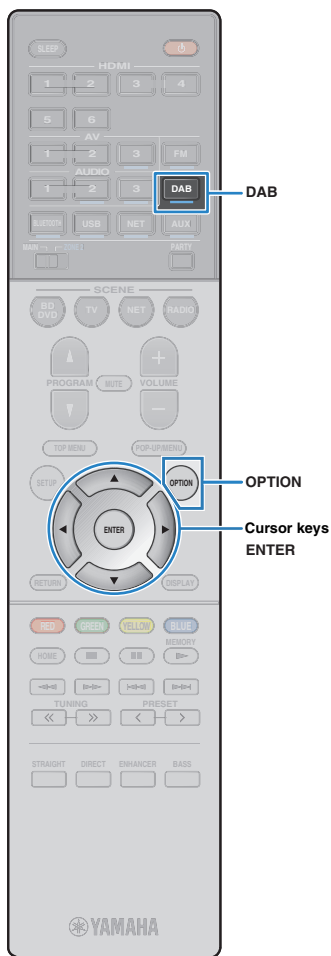

(RX-S601D)

Checking reception strength of each DAB channel label

You can check reception strength of each DAB channel label (0 [none] to 100 [best]).

- 1 Press DAB to select the DAB band.
- 2 Press OPTION.
- 3 Use the cursor keys to select “Tune Aid” and press ENTER.
- 4 Use the cursor keys (</>) to select the desired DAB channel label.



DAB channel label

Reception strength

- 5 To exit from the menu, press OPTION.

DAB frequency information

The unit supports Band III (174 to 240 MHz) only.

Frequency	Channel label	Frequency	Channel label
174.928 MHz	5A	208.064 MHz	9D
176.640 MHz	5B	209.936 MHz	10A
178.352 MHz	5C	211.648 MHz	10B
180.064 MHz	5D	213.360 MHz	10C
181.936 MHz	6A	215.072 MHz	10D
183.648 MHz	6B	216.928 MHz	11A
185.360 MHz	6C	218.640 MHz	11B
187.072 MHz	6D	220.352 MHz	11C
188.928 MHz	7A	222.064 MHz	11D
190.640 MHz	7B	223.936 MHz	12A
192.352 MHz	7C	225.648 MHz	12B
194.064 MHz	7D	227.360 MHz	12C
195.936 MHz	8A	229.072 MHz	12D
197.648 MHz	8B	230.784 MHz	13A
199.360 MHz	8C	232.496 MHz	13B
201.072 MHz	8D	234.208 MHz	13C
202.928 MHz	9A	235.776 MHz	13D
204.640 MHz	9B	237.488 MHz	13E
206.352 MHz	9C	239.200 MHz	13F



(RX-S601D)

Listening to FM radio (RX-S601D)

You can tune into an FM radio station by specifying its frequency or selecting from registered radio stations.

Selecting a frequency for reception

- 1 Press FM to select the FM band.



- 2 Press TUNING repeatedly to set a frequency.

TUNING: Increase/decrease the frequency. Hold down the key for about a second to search stations automatically.

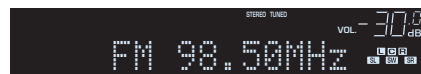

“TUNED” lights up when a signal is received from an FM radio station.

“STEREO” also lights up when a stereo signal is received.



- You can switch between “Stereo” (stereo) and “Mono” (monaural) for FM radio reception from “FM Mode” (p.80) in the “Option” menu. When the signal reception for an FM radio station is unstable, switching to monaural may improve it.
- You can watch videos input from external devices while listening to radio by selecting the video input jack in “Video Out” (p.83) in the “Option” menu.

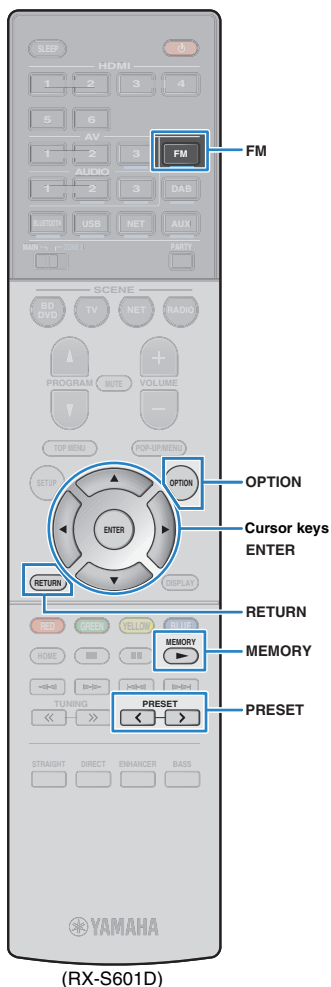

Registering favorite FM radio stations (presets)

You can register up to 40 FM radio stations as presets. Once you have registered stations, you can easily tune into them by selecting their preset numbers.



- You can register up to 40 favorite radio stations each for DAB and FM bands.

■ Registering FM radio stations automatically (Auto Preset)

Automatically register FM radio stations with strong signals (up to 40 stations).



- (U.K. and Europe models only)
Only Radio Data System broadcasting stations are stored automatically by the Auto Preset function.

- 1 Press **FM** to select the FM band.
- 2 Press **OPTION**.
- 3 Use the cursor keys to select **“Auto Preset”**.
- 4 To start the Auto Preset process, press **ENTER**.



The registration will start in 5 seconds. Press ENTER again to start the registration immediately.

“SEARCH” appears during Auto Preset



Preset number from which to start the registration



- To specify the preset number from which to start the registration, press PRESET or cursor keys (Δ/∇) to select a preset number within 5 seconds after step 4 (while “READY” is displayed) and then press ENTER (or just wait for 5 seconds).
- To cancel the Auto Preset process, press RETURN.

When the Auto Preset process finishes, “FINISH” appears and the “Option” menu closes automatically.



■ Registering an FM radio station manually

Select an FM radio station manually and register it to a preset number.

- 1 Follow **“Selecting a frequency for reception”** (p.48) to tune into the desired FM radio station.
 - 2 Hold down **MEMORY** for more than 2 seconds.
- The first time that you do register an FM radio station, the selected radio station will be registered to the preset number “01”. Thereafter, each radio station you select will be registered to the next empty (unused) preset number after the most recently registered number.



Preset number



- To select a preset number for registering, press MEMORY once after tuning into the desired radio station, press PRESET to select a preset number, and then press MEMORY again.



“Empty” (not in use) or the frequency currently registered

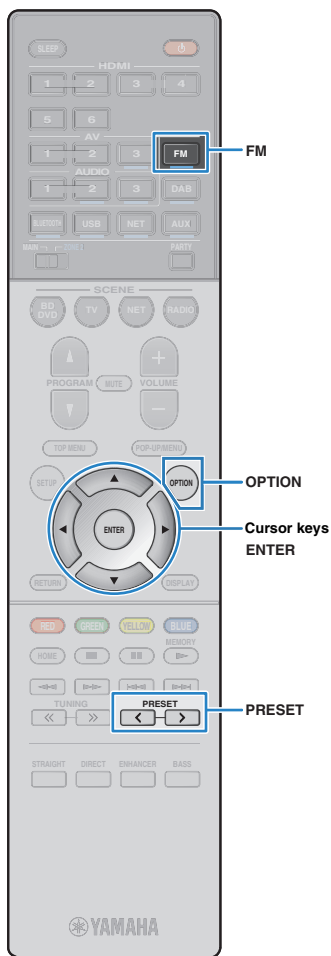

(RX-S601D)

■ Selecting a preset FM radio station

Tune into a registered FM radio station by selecting its preset number.

- 1 Press FM to select the FM band.
- 2 Press PRESET repeatedly to select the desired FM radio station.



- "No Presets" appears when no FM radio stations are registered.

■ Clearing preset FM radio stations

Clear FM radio stations registered to the preset numbers.

- 1 Press FM to select the FM band.
- 2 Press OPTION.
- 3 Use the cursor keys to select "Clear Preset" and press ENTER.



- 4 Use the cursor keys (Δ/∇) to select a preset station to be cleared and press ENTER.



Preset station to be cleared

If the preset station is cleared, "Cleared" appears and then the next in-use preset number is displayed.



- 5 Repeat step 4 until all desired preset stations are cleared.
- 6 To exit from the menu, press OPTION.

Radio Data System tuning

(U.K. and Europe models only)

Radio Data System is a data transmission system used by FM stations in many countries. The unit can receive various types of Radio Data System data, such as “Program Service”, “Program Type,” “Radio Text” and “Clock Time”, when it is tuned into a Radio Data System broadcasting station.

■ Displaying the Radio Data System information

1 Tune into the desired Radio Data System broadcasting station.



- We recommend using “Auto Preset” to tune into the Radio Data System broadcasting stations (p.57).

2 Press INFO (WPS) on the front panel.

Each time you press the key, the displayed item changes.



Item name

About 3 seconds later, the corresponding information for the displayed item appears.



Information

Program Service	Program service name
Program Type	Current program type
Radio Text	Information on the current program
Clock Time	Current time
DSP Program	Sound mode name
Audio Decoder	Decoder name
Frequency	Frequency



- “Program Service”, “Program Type”, “Radio Text”, and “Clock Time” are not displayed if the radio station does not provide the Radio Data System service.

Playing back music via BLUETOOTH

You can play back music files stored on a BLUETOOTH device (such as smartphones) on the unit.

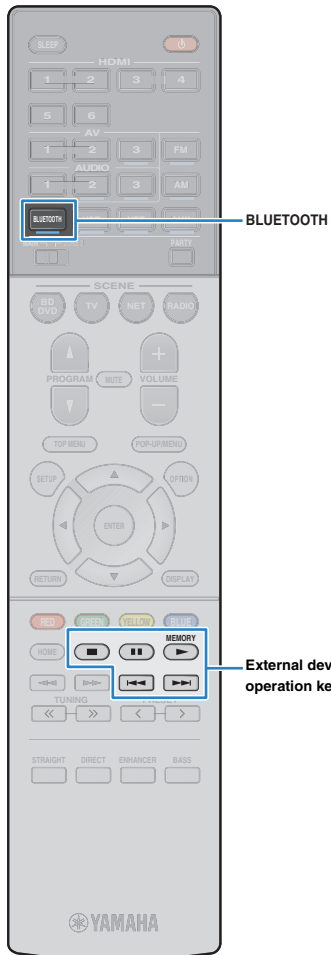

The unit



BLUETOOTH device
(such as smartphones)



- To use the BLUETOOTH function, set “Bluetooth” (p.101) in the “Setup” menu to “On”.



- For details on supported BLUETOOTH devices, see “Supported devices and file formats” (p.120).

Playback BLUETOOTH device music on the unit

Follow the procedure below to establish a BLUETOOTH connection between a BLUETOOTH device (such as smartphones) and the unit, and play back music stored the BLUETOOTH device on the unit.



- The unit does not support video playback via BLUETOOTH.

1 Press BLUETOOTH to select “Bluetooth” as the input source.

2 On the BLUETOOTH device, select the unit from the available device list.

A connection between the BLUETOOTH device and the unit will be made.

If the pass key is required, enter the number “0000”.

3 On the BLUETOOTH device, select a song and start playback.

The playback screen (artist name, album name and song title) is displayed on the TV.



- If the unit detects the BLUETOOTH device previously connected, the unit automatically connects to the BLUETOOTH device after Step 1. To establish another BLUETOOTH connection, first terminate the current BLUETOOTH connection.
- To terminate the BLUETOOTH connection, perform one of the following operations.
 - Perform the disconnect operation on the BLUETOOTH device.
 - Select an input source other than “Bluetooth” on the unit.
 - Select “Disconnect” in “Audio Receive” (p.87) in the “Setup” menu.
- You can use the external device operation keys (▶, ■, ■■, ◀◀, ▶▶) on the remote control to control playback.

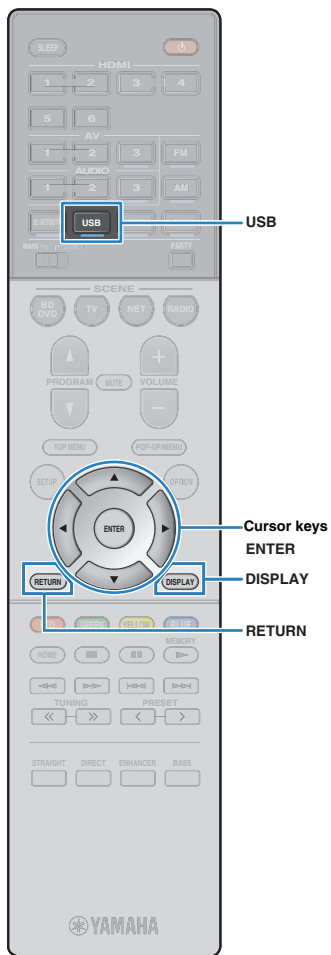

Playing back iPod music

You can play back iPod music on the unit using a USB cable supplied with the iPod.

You can also play back iPod music in other methods. For details, see the following pages.

- Playing back music with AirPlay (P.64)
- Playing back music stored on a BLUETOOTH device (P.60)
- AV CONTROLLER (P.7)



- You cannot play back iPod video on the unit.



- For details on playable iPod devices, see "Supported devices and file formats" (p.120).

Connecting an iPod

Connect your iPod to the unit with the USB cable supplied with the iPod.

- 1 Connect the USB cable to the iPod.
- 2 Connect the USB cable to the USB jack.

The unit (front)

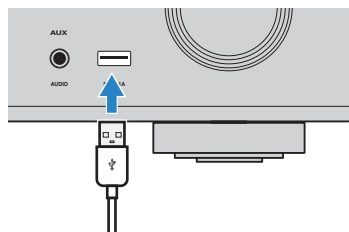

- The iPod charges while it is connected to the unit. If you set the unit to standby mode while the iPod is charging, the iPod continues to charge up to 4 hours. If "Network Standby" (p.100) in the "Setup" menu is set to "On", it continues to charge without limit.



- Disconnect the iPod from the USB jack when it is not in use.

Playback of iPod content

Follow the procedure below to operate the iPod contents and start playback.

You can control the iPod with the menu displayed on the TV screen.



- Operations with TV screen are available only when your TV is connected to the unit via HDMI. If not, carry out operations while viewing the front display, or directly operate the iPod itself in the simple play mode (p.63).
- "_" (underscore) will be displayed for characters not supported by the unit.

1 Press USB to select "USB" as the input source.

The browse screen (p.62) is displayed on the TV.



- If playback is ongoing on your iPod, the playback screen is displayed.

2 Use the cursor keys to select an item and press ENTER.

If a song is selected, playback starts and the playback screen (p.62) is displayed.



- To return to the previous screen, press RETURN.
- To switch the screen mode browse/playback/off, press DISPLAY.
- To operate the iPod manually to select content or control playback, switch to the simple play mode (p.63).

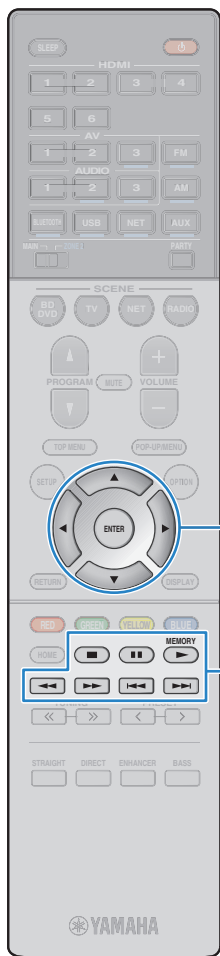

Cursor keys
ENTER

External device
operation keys

Browse screen



1 List name

2 Contents list

Displays the list of iPod content. Use the cursor keys to select an item and press ENTER to confirm the selection.

3 Item number/total

4 Status indicators

Display the current repeat/shuffle settings (p.63) and playback status (such as play/pause).

5 Operation menu

Press the cursor key (▷) and then use the cursor keys (△/▽) to select an item. Press ENTER to confirm the selection.

Icon	Function
	Moves 10 pages backward.
	Moves to the previous page of the list.
	Moves to the next page of the list.
	Moves 10 pages forward.
	Moves to the playback screen.



- A content selected by the cursor is displayed on the front display.

Playback screen



1 Status indicators

Display the current repeat/shuffle settings (p.63) and playback status (such as play/pause).

2 Playback information

Displays the artist name, album name, song title, and elapsed time/song length.

Use the following remote control keys to control playback.

External device operation keys	Function
	Resumes playback from pause.
	Stops playback.
	Stops playback temporarily.
	Skips forward/backward.
	Searches forward/backward (by holding down).



- A content name of a current playback is displayed on the front display. To switch the displayed item, press INFO (p.79).

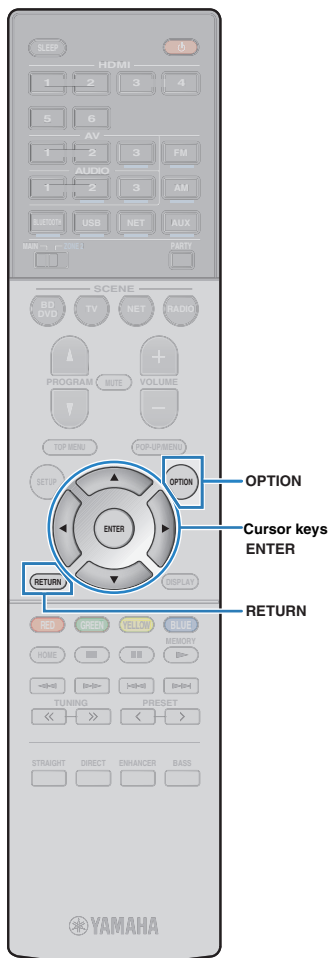

■ Operating the iPod itself (simple play)

- 1 Press **OPTION**.
- 2 Use the cursor keys to select “iPod Mode” and press **ENTER**.

The TV menu screen turns off and iPod operations are enabled.

To display the TV menu screen, select “iPod Mode” and press **ENTER** again.

- 3 Operate your iPod itself to start playback.

■ Repeat/shuffle settings

You can configure the repeat/shuffle settings of your iPod.



- During simple play, configure the repeat/shuffle settings directly on your iPod.

- 1 When “USB” is selected as the input source, press **OPTION**.
- 2 Use the cursor keys to select “Repeat” (Repeat) or “Shuffle” (Shuffle) and press **ENTER**.



- To return to the previous screen during menu operations, press **RETURN**.
- Texts in parentheses denote indicators on the front display.

- 3 Use the cursor keys (</>) to select a setting.

Item	Setting	Function
Repeat (Repeat)	Off (Off)	Turns off the repeat function.
	One (One)	Plays back the current song repeatedly. “⏮” appears in the TV screen.
	All (All)	Plays back all songs repeatedly. “⏮” appears in the TV screen.
Shuffle (Shuffle)	Off (Off)	Turns off the shuffle function.
	Songs (Songs)	Plays back songs in random order. “⚡” appears in the TV screen.
	Albums (Albums)	Plays back albums in random order. “⚡” appears in the TV screen.

- 4 To exit from the menu, press **OPTION**.

Playing back music with AirPlay

The AirPlay function allows you to play back iTunes or iPhone/iPad/iPod touch music on the unit via network.

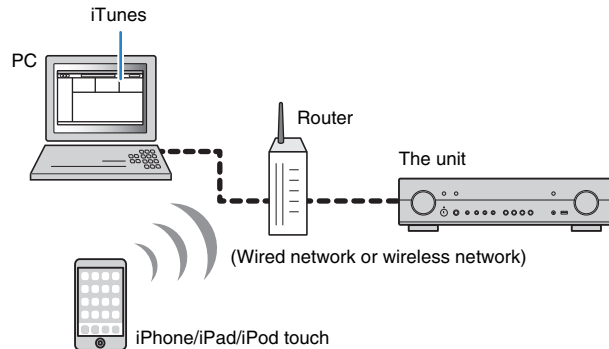

- To use this function, the unit and your PC or iPod must be connected to the same router (p.24). You can check whether the network parameters (such as the IP address) are properly assigned to the unit in "Information" (p.99) in the "Setup" menu.
- If the iPod does not recognize the unit, check your network environment (p.24).



- This section describes "iPod touch", "iPhone" and "iPad" as the "iPod". "iPod" refers to "iPod touch", "iPhone" and "iPad", unless otherwise specified.
- For details on supported iPod devices, see "Supported devices and file formats" (p.120).

Playback of iTunes/iPod music contents

Follow the procedure below to play back iTunes/iPod music contents on the unit.

1 Turn on the unit, and start iTunes on the PC or display the playback screen on the iPod.

If the iTunes/iPod recognizes the unit, the AirPlay icon () appears.

iTunes (example)



iPod iOS7/iOS8 (example)

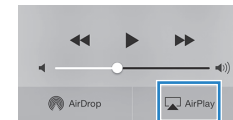

iPod iOS6 (example)

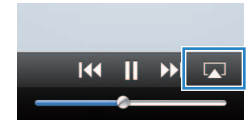

- If the icon does not appear, check whether the unit and PC/iPod are connected to the router properly.

2 On the iTunes/iPod, click (tap) the AirPlay icon and select the unit (network name of the unit) as the audio output device.

3 Select a song and start playback.

The unit automatically selects "AirPlay" as the input source and starts playback. The playback screen is displayed on the TV.



- The playback screen is available only when your TV is connected to the unit via HDMI.

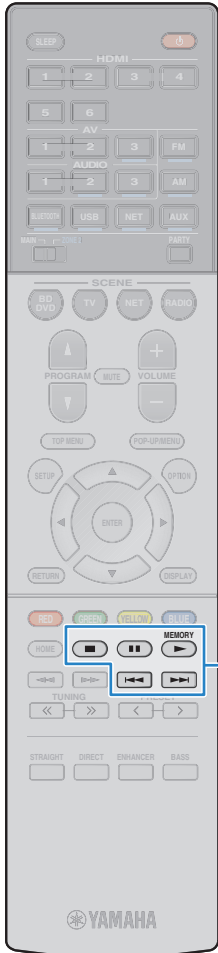

- You can turn on the unit automatically when starting playback on iTunes or iPod by setting "Network Standby" (p.100) in the "Setup" menu to "On".
- You can edit the network name (the unit's name on the network) displayed on iTunes/iPod in "Network Name" (p.100) in the "Setup" menu.
- You can adjust the unit's volume from the iTunes/iPod during playback. To disable volume controls from iTunes/iPod, set "Volume Interlock (Interlock)" (p.83) in the "Option" menu to "Off".

Caution

- When you use iTunes/iPod controls to adjust volume, the volume may be unexpectedly loud. This could result in damage to the unit or speakers. If the volume suddenly increases during playback, stop playback on the iTunes/iPod immediately.

■ Playback screen



1 Playback indicator

2 Playback information

Displays the artist name, album name, song title, and elapsed time/song length.

Use the following remote control keys to control playback.

External device operation keys	Function
	Resumes playback from pause.
	Stops playback.
	Stops playback temporarily.
	Skips forward/backward.

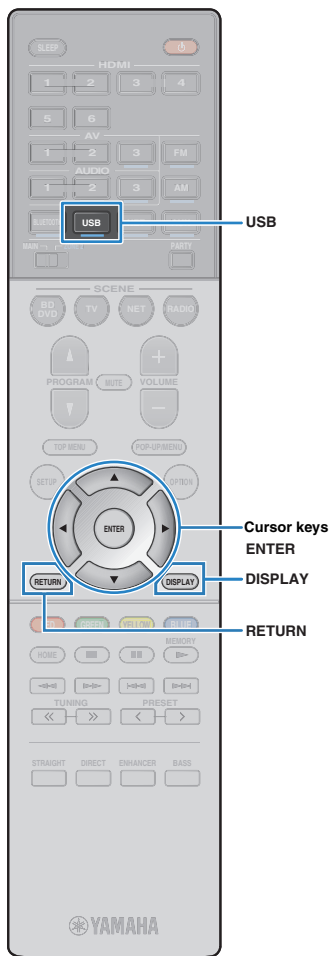

Playing back music stored on a USB storage device

You can play back music files stored on a USB storage device on the unit.



- For details on playable USB devices, see “Supported devices and file formats” (p.120).

Connecting a USB storage device

1 Connect the USB storage device to the USB jack.

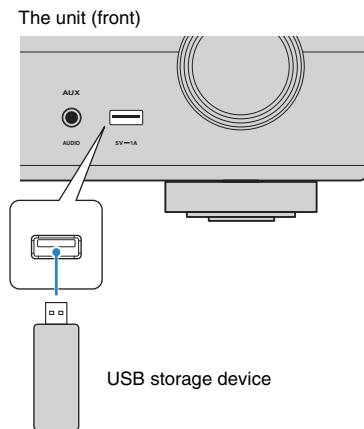

- If the USB storage device contains many files, it may take time to load them. In this case, “Loading...” appears in the front display.



- Stop playback of the USB storage device before disconnect it from the USB jack.
- Connect a USB storage device directly to the USB jack of the unit. Do not use extension cables.

Playback of USB storage device contents

Follow the procedure below to operate the USB storage device contents and start playback.

You can control the USB memory device with the menu displayed on the TV screen.



- Operations with TV screen are available only when your TV is connected to the unit via HDMI.
- “_” (underscore) will be displayed for characters not supported by the unit.

1 Press USB to select “USB” as the input source.

The browse screen (p.67) is displayed on the TV.



- If playback is ongoing on your USB storage device, the playback screen is displayed.

2 Use the cursor keys to select an item and press ENTER.

If a song is selected, playback starts and the playback screen (p.67) is displayed.



- To return to the previous screen, press RETURN.
- To switch the screen mode browse/playback/off, press DISPLAY.
- Files not supported by the unit cannot be selected.

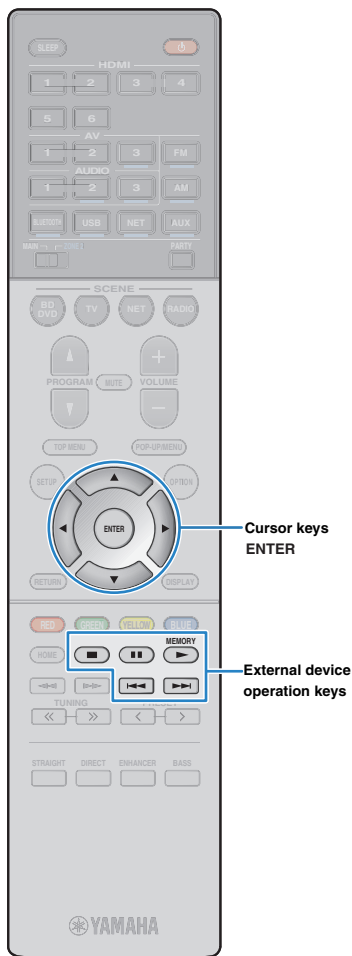

Browse screen



- 1 List name**
- 2 Contents list**
Displays the list of USB storage device contents. Use the cursor keys to select an item and press ENTER to confirm the selection.
- 3 Item number/total**
- 4 Status indicators**
Display the current repeat/shuffle settings (p.68) and playback status (such as play/pause).
- 5 Operation menu**
Press the cursor key (▷) and then use the cursor keys (△/▽) to select an item. Press ENTER to confirm the selection.

Icon	Function
	Moves 10 pages backward.
	Moves to the previous page of the list.
	Moves to the next page of the list.
	Moves 10 pages forward.
	Moves to the playback screen.



- A content selected by the cursor is displayed on the front display.

Playback screen



- 1 Status indicators**
Display the current repeat/shuffle settings (p.68) and playback status (such as play/pause).
 - 2 Playback information**
Displays the artist name, album name, song title, and elapsed time.
- Use the following remote control keys to control playback.

External device operation keys	Function
	Resumes playback from pause.
	Stops playback.
	Stops playback temporarily.
	Skips forward/backward.



- A content name of a current playback is displayed on the front display. To switch the displayed item, press INFO (p.79).

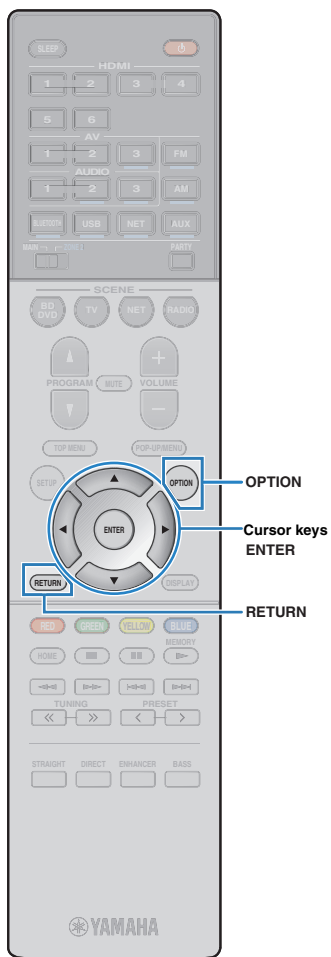

Repeat/shuffle settings



You can configure the repeat/shuffle settings for playback of USB storage device contents.

- 1 When “USB” is selected as the input source, press **OPTION**.
- 2 Use the cursor keys to select “Repeat” (Repeat) or “Shuffle” (Shuffle) and press **ENTER**.



- To return to the previous screen during menu operations, press RETURN.
- Texts in parentheses denote indicators on the front display.

- 3 Use the cursor keys (</>) to select a setting.

Item	Setting	Function
Repeat (Repeat)	Off (Off)	Turns off the repeat function.
	One (One)	Plays back the current song repeatedly. “  ” appears on the TV screen.
	All (All)	Plays back all songs in the current album (folder) repeatedly. “  ” appears on the TV screen.
Shuffle (Shuffle)	Off (Off)	Turns off the shuffle function.
	On (On)	Plays back songs in the current album (folder) in random order. “  ” appears on the TV screen.

- 4 To exit from the menu, press **OPTION**.

Playing back music stored on media servers (PCs/NAS)

You can play back music files stored on your PC or DLNA-compatible NAS on the unit.



- To use this function, the unit and your PC must be connected to the same router (p.24). You can check whether the network parameters (such as the IP address) are properly assigned to the unit in "Information" (p.99) in the "Setup" menu.
- The audio may be interrupted while using the wireless network connection. In this case, use the wired network connection.



- For details on playable file formats, see "Supported devices and file formats" (p.120).

Media sharing setup

To play back music files stored on your PC or DLNA-compatible NAS, first you need to configure the media sharing setting on each music server.

■ For a PC with Windows Media Player installed

□ For Windows Media Player 12

- 1 Start Windows Media Player 12 on your PC.
- 2 Select "Stream", then "Turn on media streaming".
- 3 Click "Turn on media streaming".
- 4 Select "Allowed" from the drop-down list next to the unit's model name.
- 5 Click "OK" to exit.

□ For Windows Media Player 11

- 1 Start Windows Media Player 11 on your PC.
- 2 Select "Library", then "Media Sharing".
- 3 Check the "Share my media to" box, select the unit's icon, and click "Allow".
- 4 Click "OK" to exit.



- For details on media sharing settings, refer to Windows Media Player help.

■ For a PC or a NAS with other DLNA server software installed

Refer to the instruction manual for the device or software and configure the media sharing settings.

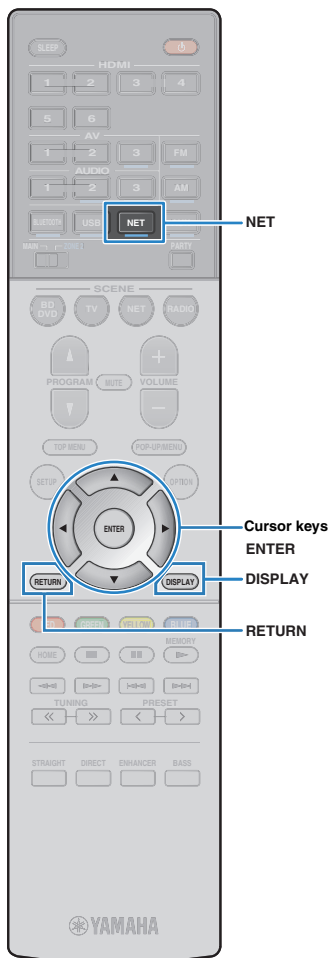

Playback of PC music contents

Follow the procedure below to operate the PC music contents and start playback.

You can control the PC/NAS with the menu displayed on the TV screen.



- Operations with TV screen are available only when your TV is connected to the unit via HDMI. If not, carry out operations while viewing the front display.
- “_” (underscore) will be displayed for characters not supported by the unit.

1 Press NET repeatedly to select “SERVER” as the input source.

The browse screen (p.70) is displayed on the TV.



- If playback of a music file selected from the unit is ongoing on your PC, the playback screen is displayed.

2 Use the cursor keys to select a music server and press ENTER.

3 Use the cursor keys to select an item and press ENTER.

If a song is selected, playback starts and the playback screen (p.71) is displayed.



- To return to the previous screen, press RETURN.
- To switch the screen mode browse/playback/off, press DISPLAY.
- Files not supported by the unit cannot be selected.

■ Browse screen



1 List name

2 Contents list

Displays the list of PC content. Use the cursor keys to select an item and press ENTER to confirm the selection.

3 Item number/total

4 Status indicators

Display the current repeat/shuffle settings (p.71) and playback status (such as play/pause).

5 Operation menu

Press the cursor key (▷) and then use the cursor keys (△/▽) to select an item. Press ENTER to confirm the selection.

Icon	Function
	Moves 10 pages backward.
	Moves to the previous page of the list.
	Moves to the next page of the list.
	Moves 10 pages forward.
	Moves to the playback screen.

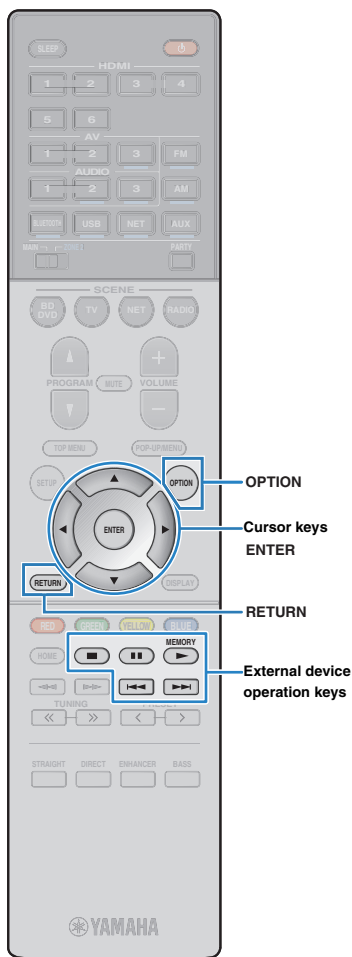

■ Playback screen



1 Status indicators

Display the current repeat/shuffle settings (p.71) and playback status (such as play/pause).

2 Playback information

Displays the artist name, album name, song title, and elapsed time.

Use the following remote control keys to control playback.

External device operation keys	Function
	Resumes playback from pause.
	Stops playback.
	Stops playback temporarily.
	Skips forward/backward.



- You can also use a DLNA-compatible Digital Media Controller (DMC) to control playback. For details, see "DMC Control" (p.100).

■ Repeat/shuffle settings

You can configure the repeat/shuffle settings for the playback of PC music content.

- When "SERVER" is selected as the input source, press **OPTION**.
- Use the cursor keys to select "Repeat" (Repeat) or "Shuffle" (Shuffle) and press **ENTER**.



- To return to the previous screen during menu operations, press **RETURN**.
- Text in parentheses denotes indicators on the front display.

3 Use the cursor keys (<|/>) to select a setting.

Item	Setting	Function
Repeat (Repeat)	Off (Off)	Turns off the repeat function.
	One (One)	Plays back the current song repeatedly. "⏮" appears on the TV screen.
	All (All)	Plays back all songs in the current album (folder) repeatedly. "⏮" appears on the TV screen.
Shuffle (Shuffle)	Off (Off)	Turns off the shuffle function.
	On (On)	Plays back songs in the current album (folder) in random order. "⏮" appears on the TV screen.

4 To exit from the menu, press **OPTION**.

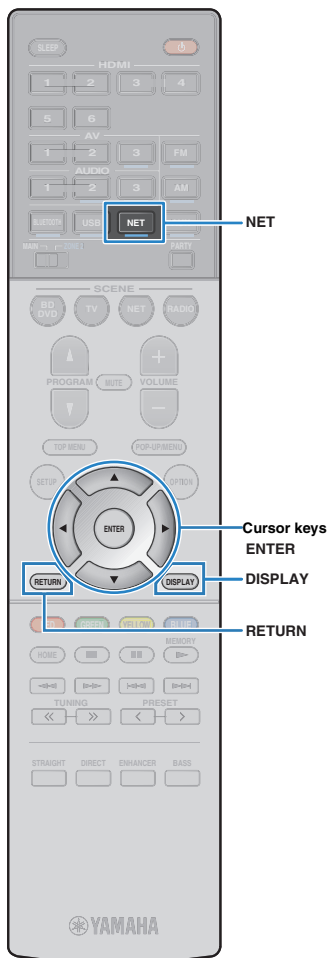

Listening to Internet radio

You can listen to Internet radio stations from all over the world.



- Operations with TV screen are available only when your TV is connected to the unit via HDMI. If not, carry out operations while viewing the front display.
- To use this function, the unit must be connected to the Internet (p.24). You can check whether the network parameters (such as the IP address) are properly assigned to the unit in "Information" (p.99) in the "Setup" menu.
- You may not be able to receive some Internet radio stations.
- The unit uses the vTuner Internet radio station database service.
- This service may be discontinued without notice.

Playback of Internet radio

Follow the procedure below to select an Internet radio station and start playback.

You can control the Internet radio with the menu displayed on the TV screen.

- 1 Press NET repeatedly to select "NET RADIO" as the input source.**

The browse screen (p.72) is displayed on the TV.

- 2 Use the cursor keys to select an item and press ENTER.**

If an Internet radio station is selected, playback starts and the playback screen (p.73) is displayed.



- To return to the previous screen, press RETURN.
- To switch the screen mode browse/playback/off, press DISPLAY.

Browse screen



- 1 List name**

- 2 Contents list**

Displays the list of Internet radio content. Use the cursor keys to select an item and press ENTER to confirm the selection.

- 3 Item number/total**

- 4 Playback indicator**

- 5 Operation menu**

Press the cursor key (▷) and then use the cursor keys (△/▽) to select an item. Press ENTER to confirm the selection.

Icon	Function
	Moves 10 pages backward.
	Moves to the previous page of the list.
	Moves to the next page of the list.
	Moves 10 pages forward.
	Moves to the playback screen.

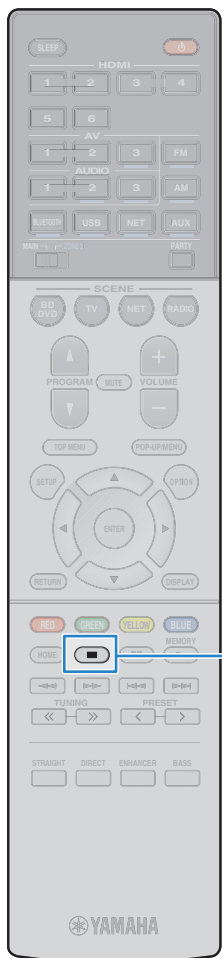

External device operation keys

■ Playback screen



1 Playback indicator

2 Playback information

Displays the station name, album name, song title, and elapsed time.



- Use the external device operation key (■) to stop playback.
- Some information may not be available depending on the station.

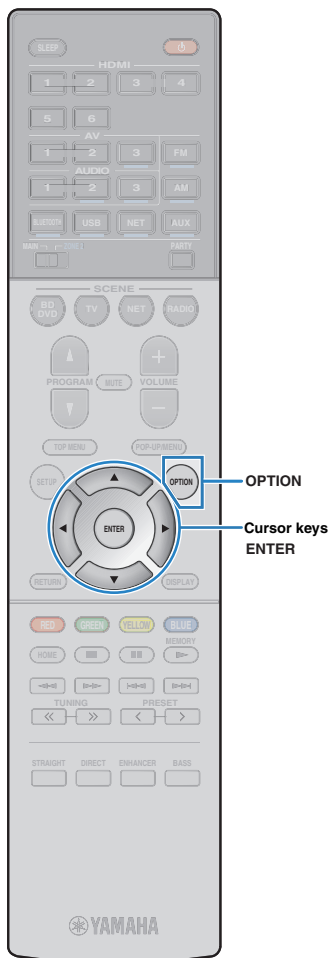

Registering favorite Internet radio stations (bookmarks)

You can register your favorite Internet radio stations to the “Bookmarks” folder.

■ Registering the station with the Option menu

Follow the procedure below to register your favorite station to the “Bookmarks” folder.

- 1 While listening to Internet radio, press **OPTION**.
- 2 Use the cursor keys to select “Bookmark On” and press **ENTER**.



- On the playback screen, the current station is added to the “Bookmarks” folder. On the browse screen, the station selected in the list is added to the “Bookmarks” folder.
- To remove stations from the “Bookmarks” folder, select the station in the folder and then “Bookmark Off”.

■ Registering the station on the vTuner website

You can also register your favorite Internet radio stations on the vTuner website.

- 1 **Select any of Internet radio stations on the unit.**
This operation is necessary to register the radio station for the first time.
- 2 **Check the vTuner ID of the unit.**

You can find the vTuner ID in “Information” (p.99) in the “Setup” menu.

- 3 **Access the vTuner website (<http://radio.vtuner.com/>) with the web browser on your PC and enter the vTuner ID.**

You can switch the language.

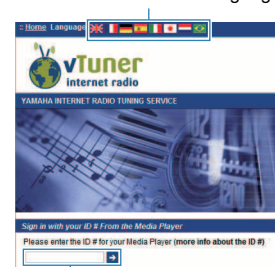

Enter the vTuner ID in this area.



- To use this feature, you need to create your personal account. Create your account using your e-mail address.

- 4 **Register your favorite radio stations.**
Click the “Add” icon (♥+) next to the station name.



- To remove the station from the “My_Favorites” folder, select “My_Favorites” in the Home screen, and then click the “Remove” icon (♥-) next to the station name.

Playing back music in multiple rooms (multi-zone)

The multi-zone function allows you to play back different input sources in the room where the unit is installed (main zone) and in another room (Zone2).

For example, while you are watching TV in the living room (main zone), another person can listen to radio in the study room (Zone2).

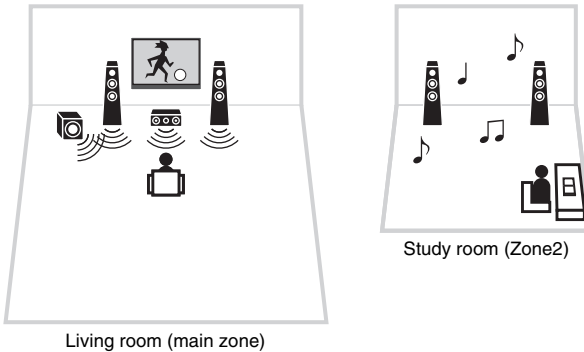

- Analog audio sources (including FM/AM or DAB/FM radio), Bluetooth, USB and network sources can be output to Zone2. To listen to the playback of an external device in Zone2, you need to connect the device to the AUDIO jacks (AV 3 or AUDIO 2–3 jacks) of the unit.
- The party mode (p.77) allows you to play back the same audio output in main zone as Zone2, whatever the input audio signal type.

Preparing Zone2

Connect the device that will be used in Zone2 to the unit.

Caution

- Remove the unit's power cable from the AC wall outlet before connecting speakers or an external amplifier.
- Ensure that the core wires of the speaker cable do not touch one another or come into contact with the unit's metal parts. Doing so may damage the unit or the speakers. If the speaker cables short circuit, "Check SP Wires" will appear on the front display when the unit is turned on.

Connect the speakers placed in Zone2 to the unit with speaker cables.

To utilize the EXTRA SP terminals for Zone2 speakers, set "Power Amp Assign" (p.88) in the "Setup" menu to "Zone2" after connecting the power cable to an AC wall outlet.

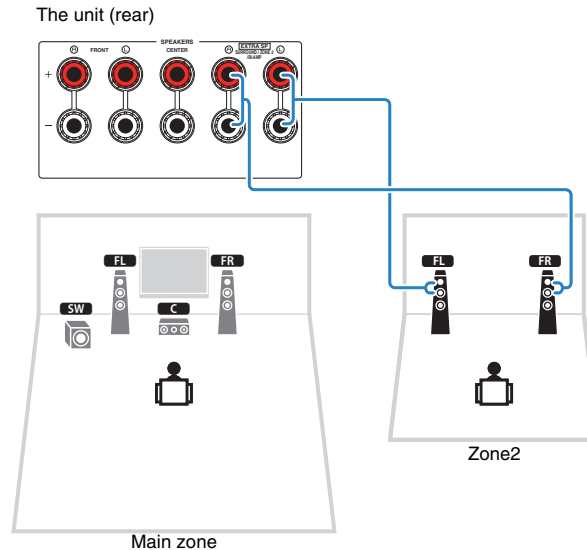

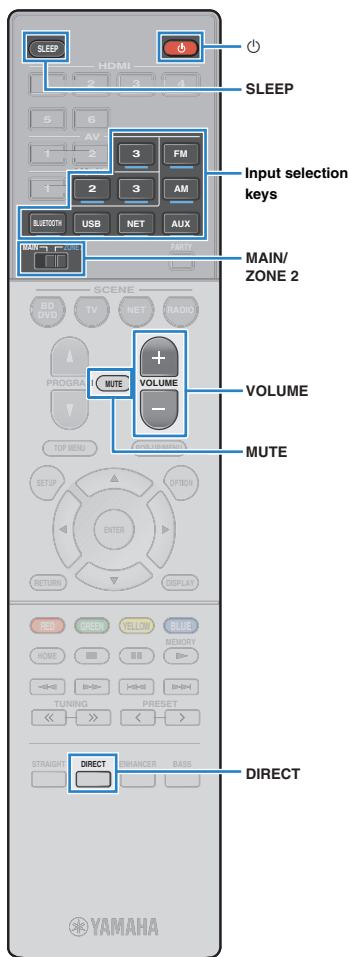

Controlling Zone2

1 Set MAIN/ZONE 2 to “ZONE 2”.

2 Press (receiver power).

Each time you press the key, Zone2 output is enabled or disabled.

When Zone2 output is enabled, “ZONE 2” lights up in the front display.



- You can enable/disable Zone2 output using the ZONE key on the front panel (p.8).

3 Use the following keys to select an input source.

AV 3: AV 3 (audio) jacks

AUDIO 2–3: AUDIO 2–3 jacks

AUX: AUX jack

FM: FM radio

AM: AM radio (RX-S601)

DAB: DAB radio (RX-S601D)

BLUETOOTH: *Bluetooth* connection (the unit as a *Bluetooth* receiver)

USB: USB jack

NET: Network sources (press repeatedly to select a desired network source)



- You cannot select Bluetooth, USB and network sources exclusively for each zone. For example, if you select “SERVER” for Zone2 when “USB” is selected for the main zone, the input source for the main zone also switches to “SERVER”.
- An input source for Zone2 can only be selected using the input selection keys on the remote control.



- It is useful to assign the frequently-used input to the SCENE key (p.77).

4 Start playback on the external device or select a radio station.

Refer to the instruction manual for the external device.

For details on the following operations, see the corresponding pages.

- Listening to FM/AM radio (RX-S601) (p.48)
- Listening to DAB/FM radio (RX-S601D) (p.52)
- Playing back music via *Bluetooth* (p.60)
- Playing back iPod music (p.61)
- Playing back music stored on a USB storage device (p.66)
- Playing back music stored on media servers (PCs/NAS) (p.69)
- Listening to Internet radio (p.72)
- Playing back iTunes/iPod music via a network (AirPlay) (p.64)



- The on-screen operations are not available for Zone2. Use the front display to control Zone2.
- AirPlay is available in Zone2 only when AirPlay playback is ongoing in the main zone.
- Zone2 output is disabled when DIRECT is pressed to enable direct playback mode. Press DIRECT to disable direct playback mode, and follow the procedure from step 2 to enable Zone2 output.



- To set the sleep timer (120 min, 90 min, 60 min, 30 min, off), press SLEEP repeatedly. The Zone2 output will be disabled after a specified period of time.
- To adjust the Zone2 volume, press VOLUME or MUTE.
- To play back DSD audio in Zone2, enable the party mode (p.77).

Caution

- To avoid unexpected noise, never play back DTS-CDs in Zone2.

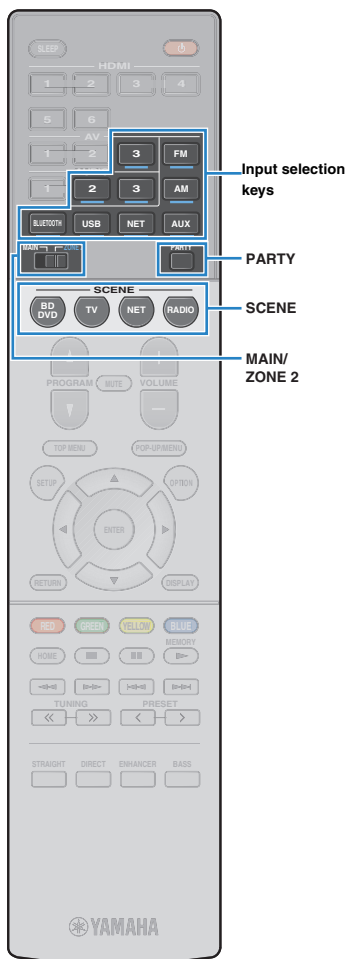

■ Selecting the input source with the SCENE function

You can use the SCENE function to select the input source for Zone2 playback.



- To use the SCENE function in Zone2, you must configure scene assignments separately from the main zone settings.
- You can register only the input source to the SCENE key. By default, the following settings are registered for each scene.
 - BD/DVD: AV 3
 - TV: AUDIO 2
 - NET: NET RADIO
 - RADIO: TUNER

1 Set MAIN/ZONE 2 to “ZONE 2”.

2 Press SCENE.

The input source registered to the corresponding scene is selected and Zone2 output is enabled.

□ Configuring scene assignments

1 Set MAIN/ZONE 2 to “ZONE 2”.

2 Select a Zone2 input source.

3 Hold down the desired SCENE key until “SET Complete” appears on the front display.

■ Enjoying the same source in multiple rooms (party mode)

The party mode allows you to play back in Zone2 the same music that is being played back in the main zone. During the party mode, stereo playback is automatically selected for all zones. Utilize this function when you want to use main zone music as background music for a house party.

1 Press PARTY.

Each time you press the key, the party mode is turned on or off.

When the party mode is turned on, “PARTY” lights up in the front display.



- The party mode is not available when the unit is in direct playback mode.



Useful functions

Registering favorite items (shortcut)

You can register up to 40 favorite USB and network contents as shortcuts and access them directly by selecting the shortcut numbers.



- You can also use the “Bookmark” feature to register Internet radio stations (p.74).
- BLUETOOTH and AirPlay are applied to the input source. You cannot register particular songs in the device individually.

Registering an item

Select a desired item and register it to a shortcut number.

1 Play back a song or a radio station to be registered.

2 Hold down MEMORY for 3 seconds.



Shortcut number (flashes)



- To change a shortcut number to which the item will be registered, use PRESET to select the shortcut number after step 2.



“Empty” (not in use) or item currently registered

3 To confirm the registration, press MEMORY.

Recalling a registered item

Recall a registered item by selecting the shortcut number.

1 Press BLUETOOTH, NET or USB.

2 Press PRESET repeatedly to select a desired item.



- “No Presets” appears when no items are registered.
- The registered item cannot be recalled in the following cases.
 - A USB storage device which contains the registered item is not connected to this unit.
 - A PC which contains the registered item is turned off or not connected to the network.
 - The registered network content is temporarily unavailable or out of service.
 - The registered item (file) has been deleted or moved to another location.
 - A BLUETOOTH connection cannot be established.
- When you register music files stored on a USB storage device or a PC, this unit memorizes the relative position of the music files in the folder. If you have added or deleted any music files to or from the folder, this unit may not recall the music file correctly. In such cases, register the items again.

Switching information on the front display

1 Press INFO (WPS) on the front panel.

Each time you press the key, the displayed item changes.



Item name

About 3 seconds later, the corresponding information for the displayed item appears.



Information



- Available items vary depending on the selected input source. The displayed item can also be applied separately to each input source group.

Input source group	Item
HDMI	
AV	Input (input source name), DSP Program (sound mode name), Audio Decoder (decoder name*)
AUX	
AUDIO	
BLUETOOTH	Song (song title), Artist (artist name), Album (album name), DSP Program (sound mode name), Audio Decoder (decoder name*)
USB	During simple playback of iPod:
SERVER	Input (input source name), DSP Program (sound mode name), Audio Decoder (decoder name)
AirPlay	
NET RADIO	Song (song title), Album (album name), Station (station name), DSP Program (sound mode name), Audio Decoder (decoder name*)
TUNER (FM/AM)	Frequency (frequency), DSP Program (sound mode name), Audio Decoder (decoder name*) (U.K. and Europe models only) Radio Data System data is also available when the unit is tuned into a Radio Data System broadcasting station (p.51, 59).
TUNER (DAB)	See "Displaying the DAB information" (p.54) for details.

* The name of the audio decoder currently activated is displayed. If no audio decoder is activated, "Decoder Off" appears.

Configuring playback settings for different playback sources (Option menu)

You can configure separate playback settings for different playback sources. This menu is available on the front panel (or on the TV screen), allowing you to easily configure settings during playback.

1 Press **OPTION**.



Front display

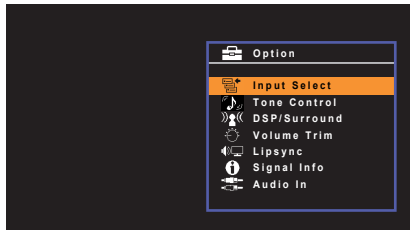

TV screen

2 Use the cursor keys to select an item and press **ENTER**.



- To return to the previous screen during menu operations, press RETURN.

3 Use the cursor keys (</>) to select a setting.

4 To exit from the menu, press **OPTION**.

Option menu items



- Available items vary depending on the selected input source.
- Text in parentheses denotes indicators on the front display.
- Default settings are underlined.
- Depending on the region of purchase, some menu items for audio streaming services are also available. For details, refer to each manual on the supplied CD-ROM.

Item	Function	Page	
Input Select (Input)	Switches the input source.	81	
Tone Control (Tone Control)	Adjusts the high-frequency range and low-frequency range of sounds.	81	
DSP/Surround (DSP/Surround)	Program (PRG)	Select the sound programs and stereo playback.	44
	Sur.Decode (SrDec)	Select which surround decoder is used when Sur.Decode is selected as the program.	46
	DSP Level (DSP Level)	Adjusts the sound field effect level.	81
	Adaptive DRC (A.DRC)	Sets whether the dynamic range (from maximum to minimum) is automatically adjusted when the volume is adjusted.	81
Volume Trim (Volume Trim)	Enhancer (Enhancer)	Enables/disables Compressed Music Enhancer.	81
	Input Trim (In.Trim)	Corrects volume differences between input sources.	82
	Subwoofer Trim (SW.Trim)	Fine-adjusts the subwoofer volume.	82
Lipsync (Lipsync)	Enables/disables the "Lipsync" setting in the "Setup" menu.	82	
Signal Info (Signal Info)	Displays information about the video/audio signal.	82	
Audio In (Audio)	Combines the video jack of the selected input source with an audio jack of others.	82	
Video Out (Video)	Selects a video to be output with radio sounds.	83	
FM Mode (FM Mode)	Switches between "Stereo" and "Mono" for FM radio reception.	48, 56	
Auto Preset (Auto Preset)	Automatically registers FM radio stations with strong signals as presets.	49, 57	
Clear Preset (Clear Preset)	Clear radio stations registered to preset numbers.	50, 58	
Traffic Program (TrafficProgram)	(U.K. and Europe models only) Automatically searches for a traffic information station.	51	
iPod Mode (iPod Mode)	Switches the iPod operation mode.	63	

Item	Function	Page
Repeat (Repeat)	Configures the repeat setting for the iPod (p.63), USB storage device (p.68), or media server (p.71).	—
Shuffle (Shuffle)	Configures the shuffle setting for the iPod (p.63), USB storage device (p.68), or media server (p.71).	—
Volume Interlock (Interlock)	Enables/disables volume controls from iTunes/iPod via AirPlay.	83
Bookmark On (Bookmark On) Bookmark Off (Bookmark Off)	Adds your favorite Internet radio station to the "Bookmarks" folder, or removes it from the "Bookmarks" folder.	74
Init Scan (Init Scan)	(RX-S601D only) Performs an initial scan for DAB radio reception.	52
Tune Aid (Tune Aid)	(RX-S601D only) Checks reception strength of each DAB channel.	55

■ Input Select (Input)

Switches the input source. Press ENTER to switch to the selected input source.

Choices

HDMI 1–6, AUDIO 1–3, AV 1–3, TUNER, USB, SERVER, NET RADIO, Airplay, (network sources), Bluetooth, AUX

■ Tone Control (Tone Control)

Adjusts the high-frequency range (Treble) and low-frequency range (Bass) of sounds.

Choices

Treble (Treble), Bass (Bass)

Setting range

-6.0 dB to Bypass (Bypass) to +6.0 dB (0.5 dB increments)



- If you set an extreme value, sounds may not match those from other channels.

■ DSP/Surround (DSP/Surround)

Configures the sound field program and surround settings.

□ DSP Level (DSP Level)

Adjusts the sound field effect level.

Setting range

-6 dB to 0 dB to +3 dB

□ Adaptive DRC (A.DRC)

Sets whether the dynamic range (from maximum to minimum) is automatically adjusted when the volume level is adjusted. When it is set to "On", it is useful for listening to playback at a low volume at night.

Settings

On (On)	Automatically adjusts the dynamic range.
Off (Off)	The dynamic range is not automatically adjusted.

If "On" is selected, the dynamic range becomes narrow at a low volume and wide at a high volume.

□ Enhancer (Enhancer)

Enables/disables Compressed Music Enhancer (p.47).



- This setting is applied separately to each input source.
- You can also use ENHANCER on the remote control to enable/disable Compressed Music Enhancer (p.47).

Settings

Off (Off)	Disables Compressed Music Enhancer.
On (On)	Enables Compressed Music Enhancer.

Default

TUNER, USB, SERVER, NET RADIO, AirPlay, (network sources), Bluetooth: On (On)
Others: Off (Off)

■ Volume Trim (Volume Trim)

Fine-adjusts volume difference between input sources or subwoofer volume.

□ Input Trim (In.Trim)

Corrects volume differences between input sources. If you are bothered by volume differences when switching between input sources, use this function to correct it.



- This setting is applied separately to each input source.

Setting range

-6.0 dB to 0.0 dB to +6.0 dB (0.5 dB increments)

□ Subwoofer Trim (SW.Trim)

Fine-adjusts the subwoofer volume.

Setting range

-6.0 dB to 0.0 dB to +6.0 dB (0.5 dB increments)

■ Lipsync (Lipsync)

Enables/disables the adjustment configured in “Lipsync” (p.94) in the “Setup” menu.



- This setting is applied separately to each input source.

Settings

Off (Off)	Disables the “Lipsync” adjustment.
On (On)	Enables the “Lipsync” adjustment.

Default

AirPlay: Off (Off)
Others: On (On)

■ Signal Info (Signal Info)

Displays information about the video/audio signal.

Choices

Format (FORMAT)	Audio format of the input signal
Channel (CHANNEL)	The number of source channels in the input signal (front/surround/LFE) For example, “3/2/0.1” means 3 front channels, 2 surround channels, and LFE.
Sampling (SAMPLING)	The number of samples per second of the input digital signal
Bitrate (BITRATE)	The amount of data per second of the input bitstream signal
Video In (VIDEO IN)	Type and resolution of the input digital signal
Video Out (VIDEO OUT)	Type and resolution of the output digital signal



- To switch the information on the front display, press the cursor keys (Δ/∇) repeatedly.

■ Audio In (Audio)

Combines the video jack of the selected input source (HDMI 1–6 or AV 1–3) with an audio jack of others. For example, use this function in the following cases.

- Connecting a playback device that supports HDMI video output, but not HDMI audio output
- Connecting a playback device that has component video jacks and analog stereo jacks (such as game consoles)

Input sources

HDMI 1–6, AUDIO 1–3, AV 1–3

■ Setup procedure

See “Changing the combination of video/audio input jacks” (p.21).

■ Video Out (Video)

Selects a video to be output with the selected audio source. For example, you can watching the video while listening to the radio.

Input sources

TUNER, USB, Bluetooth, AUX

Settings

Off (Off)	Does not output video.
HDMI 1-6, AV 1-3	Outputs video input through the corresponding video input jacks.

■ Volume Interlock (Interlock)

Enables/disables volume controls from iTunes/iPod via AirPlay.

Settings

Off (Off)	Disables volume controls from iTunes/iPod.
Limited (Ltd)	Enables volume controls from iTunes/iPod within the limited range (-80 dB to -20 dB and mute).
Full (Full)	Enables volume controls from iTunes/iPod in the full range (-80 dB to +16.5 dB and mute).

CONFIGURATIONS

Configuring various functions (Setup menu)

You can configure the unit's various function with the menu displayed on the TV screen.



- Operations with TV screen are available only when your TV is connected to the unit via HDMI. If not, carry out operations while viewing the front display.



- If new firmware is available, the envelope icon (✉) appears in the screen.

1 Press **SETUP**.

2 Use the cursor keys to select a menu and press **ENTER**.

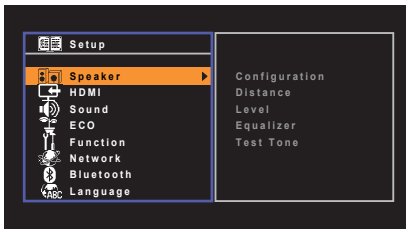

3 Use the cursor keys to select an item and press **ENTER**.

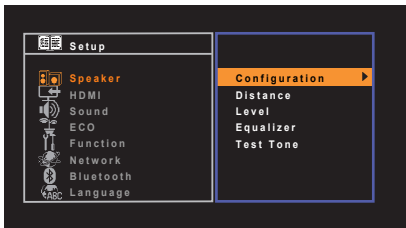

- To return to the previous screen during menu operations, press **RETURN**.

4 Use the cursor keys (</>) to select a setting and press **ENTER**.

5 To exit from the menu, press **SETUP**.

Setup menu items

Menu	Item	Function	Page	
Speaker	Configuration	Power Amp Assign	Selects a speaker system.	88
		Subwoofer	Selects whether or not a subwoofer is connected.	88
		Front	Selects the size of the front speakers.	88
		Center	Selects whether or not a center speaker is connected and its size.	88
		Surround	Selects whether or not surround speakers are connected and their size.	89
		Crossover	Sets the lower limit of the low-frequency component that can be output from speakers whose size is set to "Small".	89
		Subwoofer Phase	Sets the phase of the subwoofer.	89
		Extra Bass	Enables/disables Extra Bass.	89
	Virtual CINEMA FRONT	Selects whether to use the front 5-channel speaker (Virtual CINEMA FRONT) configuration.	89	
	Distance	Sets the distance between each speaker and listening position.	89	
	Level	Adjusts the volume of each speaker.	90	
Equalizer	Adjusts the tone with an equalizer.	90		
Test Tone	Enables/disables the test tone output.	90		
HDMI	Configuration	HDMI Control	Enables/disables HDMI Control.	91
		Audio Output	Selects a device to output audio.	91
		Standby Through	Selects whether to output videos/audio (input through HDMI jacks) to the TV when the unit is in standby mode.	91
		TV Audio Input	Selects an audio input jack of the unit to be used for TV audio input.	91
		Standby Sync	Selects whether to use HDMI control to link the standby behavior of the TV and the unit.	92
		ARC	Enables/disables ARC.	92
		SCENE	Enables/disables SCENE link playback.	92

Menu	Item	Function	Page	
Sound	DSP Parameter	CINEMA DSP 3D Mode	Enables/disables CINEMA DSP 3D.	93
		Panorama	Enables/disables the broadening effect of the front sound field.	93
		Center Width	Adjusts the broadening effect of the center sound field.	93
		Dimension	Adjusts the difference in level between the front and surround sound fields.	93
		Center Image	Adjusts the center orientation level (broadening effect) of the front sound field.	93
	Lipsync	Select	Selects the method to adjust the delay between video and audio output.	94
		Adjustment	Adjusts the delay between video and audio output manually.	94
	Volume	Scale	Switches the scale of the volume display.	94
		Dynamic Range	Selects the dynamic range adjustment method for bitstream audio (Dolby Digital and DTS signals) playback.	94
		Main Zone Max Volume	Sets the main zone maximum volume to prevent excessive loudness.	94
		Main Zone Initial Volume	Sets the main zone initial volume when the unit is turned on.	94
		Zone2 Max Volume	Sets the Zone2 maximum volume to prevent excessive loudness.	95
		Zone2 Initial Volume	Sets the Zone2 initial volume when the Zone2 output is enabled.	95
ECO	Auto Power Standby	Set the amount of time for the auto-standby function.	96	
	ECO Mode	Enables/disables the eco mode (power saving mode).	96	
Function	Input Rename	Changes the input source name displayed on the front display.	97	
	Input Skip	Set which input source is skipped when operating the INPUT knob on the front panel.	97	
	Dimmer	Adjusts the brightness of the front display.	97	
	Memory Guard	Prevents accidental changes to the settings.	97	
	Remote Color Key	Set the unit's functions for the RED/GREEN/YELLOW/BLUE key of the remote control.	98	
	Party Mode Set	Enables/disables switching to the party mode.	98	
	Network	Information	Displays the network information on the unit.	99
Network Connection		Selects the network connection method.	99	
IP Address		Configures the network parameters (such as IP address).	99	
MAC Address Filter		Sets the MAC address filter to limit access to the unit from other network devices.	100	
DMC Control		Selects whether to allow a DLNA-compatible Digital Media Controller (DMC) to control playback.	100	
Network Standby		Selects whether to enable/disable the function that turns on the unit from other network devices.	100	
Network Name		Edits the network name (the unit's name on the network) displayed on other network devices.	100	
Network Update		Updates the firmware via the network.	101	

Menu	Item	Function	Page
	Bluetooth	Enables/disables the BLUETOOTH functions.	101
Bluetooth	Audio Receive Disconnect	Terminates the BLUETOOTH connection between the BLUETOOTH device (such as smartphones) and the unit.	60
	Bluetooth Standby	Selects whether to enable/disable the function that turns on the unit from BLUETOOTH devices (BLUETOOTH standby).	101
Language		Select an on-screen menu language.	102

Speaker

Configures the speaker settings manually.



- Default settings are underlined.

Configuration

Configures the output characteristics of the speakers.



- When you configure the speaker size, select “Large” if the woofer diameter of your speaker is 16 cm (6-1/4”) or larger or “Small” if it is smaller than 16 cm (6-1/4”).

Power Amp Assign

Selects a speaker system.

In addition to the 5.1-channel speaker system, various speaker configurations are possible using the Zone2 speakers or bi-amp connection.

Settings

<u>Basic</u>	Select this option when you use a normal speaker system (not using Zone2 speakers or a bi-amp connection).
BI-AMP	Select this option when you connect front speakers that support bi-amp connections (p.17).
Zone2	Select this option when you use Zone2 speakers (p.75) in addition to the speaker system in the main zone.

Subwoofer

Selects whether or not a subwoofer is connected.

Settings

<u>Use</u>	Select this option when a subwoofer is connected. The subwoofer will produce LFE (low-frequency effect) channel audio and low-frequency components from other channels.
None	Select this option when no subwoofer is connected. The front speakers will produce LFE (low-frequency effect) channel audio and low-frequency components from other channels.

Front

Selects the size of the front speakers.

Settings

<u>Small</u>	Select this option for small speakers. The subwoofer will produce front channel low-frequency components (configurable in “Crossover”).
Large	Select this option for large speakers. The front speakers will produce all of the front channel frequency components.



- “Front” is automatically set to “Large” when “Subwoofer” is set to “None”.

Center

Selects whether or not a center speaker is connected and its size.

Settings

<u>Small</u>	Select this option for small speakers. The subwoofer or front speakers will produce center channel low-frequency components (configurable in “Crossover”).
Large	Select this option for large speakers. The center speaker will produce all of the center channel frequency components.
None	Select this option when no center speaker is connected. The front speakers will produce center channel audio.

Surround

Selects whether or not surround speakers are connected and their sizes.

Settings

Small	Select this option for small speakers. The subwoofer or front speakers will produce surround channel low-frequency components (configurable in "Crossover").
Large	Select this option for large speakers. The surround speakers will produce all of the surround channel frequency components.
None	Select this option when no surround speakers are connected. The front speakers will produce surround channel audio. Virtual CINEMA DSP works when you select a sound program.

Crossover

Sets the lower limit of the low-frequency components that can be output from a speaker whose size is set to "Small". A frequency sound lower than the specified value will be produced from the subwoofer or front speakers.

Settings

40 Hz, 60 Hz, 80 Hz, 90 Hz, 100 Hz, 110 Hz, 120 Hz, 160 Hz, 200 Hz



- If the volume and crossover frequency are adjustable on your subwoofer, set the volume to half and crossover frequency to maximum.

Subwoofer Phase

Sets the phase of the subwoofer. When the bass sound is lacking or unclear, switch the subwoofer phase.

Settings

Normal	Does not reverse the subwoofer phase.
Reverse	Reverses the subwoofer phase.

Extra Bass

Enables/disables Extra Bass. When Extra Bass is enabled, you can enjoy enhanced bass sounds, regardless of the size of the front speakers and the presence or absence of the subwoofer.

Settings

Off	Disables Extra Bass.
On	Enables Extra Bass.



- You can also use BASS on the remote control to enable/disable Extra Bass (p.47).

Virtual CINEMA FRONT

Selects whether to use the front 5-channel speaker (Virtual CINEMA FRONT) configuration.

Settings

Off	Disables the front 5-channel speaker configuration.
On	Enables the front 5-channel speaker configuration.



- Select "On" only when utilizing the Virtual CINEMA FRONT configuration (p.14).
- This setting is not available when "Surround" is set to "None".

Distance

Sets the distance between each speaker and listening position so that sounds from the speakers reach the listening position at the same time. First, select the unit of distance from "Meter" or "Feet".

Choices

Front L, Front R, Center, Surround L, Surround R, Subwoofer

Setting range

0.30 m to 24.00 m (1.0 ft to 80.0 ft), 0.05 m (0.2 ft) increments

Default

Front L, Front R, Subwoofer: 3.00 m (10.0 ft)

Center: 2.60 m (8.6 ft)

Others: 2.40 m (8.0 ft)

Level

Adjusts the volume of each speaker.

Choices

Front L, Front R, Center, Surround L, Surround R, Subwoofer

Setting range

-10.0 dB to +10.0 dB (0.5 dB increments)

Default

Front L, Front R, Subwoofer: 0.0 dB

Others: -1.0 dB

Equalizer

Adjusts the tone with an equalizer.

EQ Select

Selects the type of equalizer to be used.

Settings

PEQ	Applies the parametric equalizer values obtained by the YPAO measurement (p.27).
GEQ	Select this option when you want to adjust the equalizer manually. For details, see "Manual equalizer adjustment".
Off	Does not use the equalizer.



- "PEQ" is available only when the YPAO has been performed (p.27).

Manual equalizer adjustment

- 1 Set "EQ Select" to "GEQ".
- 2 Use the cursor keys (Δ/∇) to select "Channel" and the cursor keys (\leftarrow/\rightarrow) to select the desired speaker channel.

- 3 Use the cursor keys (Δ/∇) to select the desired band (frequency) and the cursor keys (\leftarrow/\rightarrow) to adjust the gain.

Setting range

-6.0 dB to +6.0 dB

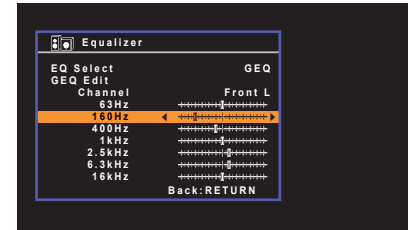

- 4 To exit from the menu, press SETUP.

Test Tone

Enables/disables the test tone output. Test tone output helps you to adjust the speaker balance or equalizer while confirming its effect.

Settings

Off	Does not output test tones.
On	Outputs test tones automatically when you adjust the speaker balance or equalizer.

HDMI

Configures the HDMI settings.



- Default settings are underlined.

■ Configuration

HDMI Control

Enables/disables HDMI Control (p.122).

Settings

<u>Off</u>	Disables HDMI Control.
On	Enables HDMI Control. Configure the settings in "TV Audio Input", "Standby Sync", "ARC", and "SCENE".



- To use HDMI control, you need to perform the HDMI Control link setup (p.122) after connecting HDMI Control-compatible devices.

Audio Output

Selects a device to output audio.



- This setting is available only when "HDMI Control" is set to "Off".

Amp

Enables/disables the audio output from the speakers connected to the unit.

Settings

Off	Disables the audio output from the speakers.
<u>On</u>	Enables the audio output from the speakers.

HDMI OUT (TV)

Enables/disables the audio output from a TV connected to the HDMI OUT jack.

Settings

<u>Off</u>	Disables the audio output from the TV.
On	Enables the audio output from the TV.

Standby Through

Select whether to output videos/audio (input through HDMI jacks) to the TV when the unit is in standby mode. If this function is set to "On" or "Auto", you can use the input selection keys (HDMI 1–6) to select an HDMI input even when the unit is in standby mode (the standby indicator on the unit blinks).

Settings

<u>Off</u>	(When "HDMI Control" is set to "Off") Does not output videos/audio to the TV.
Auto	Automatically selects whether to output videos/audio depending on the status of the connected device.
On	Outputs videos/audio to the TV. (The unit consumes more power than when "Off" is selected.)

TV Audio Input

Selects an audio input jack of the unit to be used for TV audio input when "HDMI Control" is set to "On". The unit's input source automatically switches to TV audio when the TV input is switched to its built-in tuner.

Settings

AUDIO 1–3, AV 1–3

Default

AV1



- When using ARC to input TV audio to the unit, you cannot use the input jacks selected here for connecting an external device because the input will be used for TV audio input.

Standby Sync

Select whether to use HDMI control to link the standby behavior of the TV and the unit when "HDMI Control" is set to "On".

Settings

Off	Does not set the unit to standby mode when the TV is turned off.
On	Sets the unit to standby mode when the TV is turned off.
Auto	Sets the unit to standby mode when the TV is turned off only when the unit is receiving TV audio or HDMI signals.

ARC

Enables/disables ARC (p.19) when "HDMI Control" is set to "On".

Settings

Off	Disables ARC.
On	Enables ARC.



- You do not need to change this setting normally. In case noises are produced from the speakers connected to the unit because TV audio signals input to the unit via ARC are not supported by the unit, set "ARC" to "Off" and use the TV's speakers.

SCENE

Enables/disable SCENE link playback when "HDMI Control" is set to "On". When SCENE link playback is enabled, HDMI Control-compatible devices connected to the unit via HDMI automatically works as follows, with a scene selection.

- TV: turning on and displaying video from the playback device
- Playback device: starting playback

Choices (SCENE keys)

BD/DVD, TV, NET, RADIO

Settings

Off	Disables SCENE link playback for the selected SCENE key.
On	Enables SCENE link playback for the selected SCENE key.

Default

BD/DVD, TV: On
NET, RADIO: Off



- SCENE link playback may not work properly due to the compatibility between devices. We recommend using TV and playback devices from the same manufacturer so that HDMI Control works more effectively.

Sound

Configures the audio output settings.



- Default settings are underlined.

DSP Parameter

Configures the surround decoder settings.

CINEMA DSP 3D Mode

Enables/disables CINEMA DSP 3D (p.44). If this function is set to "On", CINEMA DSP 3D functions with the selected sound programs (except 2ch Stereo and 5ch Stereo).

Settings

<u>Off</u>	Disables CINEMA DSP 3D.
<u>On</u>	Enables CINEMA DSP 3D.

Panorama

Enables/disables the broadening effect of the front sound field. When this function is enabled, you can wrap front left/right channel sounds around the field and generate a spacious sound field in combination with the surround sound field. This setting is effective when "DOLBII Music" is selected.

Settings

<u>Off</u>	Disables the broadening effect of the front sound field.
<u>On</u>	Enables the broadening effect of the front sound field.

Center Width

Adjusts the broadening effect of the center sound field. Higher to enhance the broadening effect, and lower to reduce it (closer to center). This setting is effective when "DOLBII Music" is selected.

Setting range

0 to 3 to 7

Dimension

Adjusts the difference in level between the front and surround sound fields. Higher to strengthen the front sound field and lower to strengthen the surround sound field. This setting is effective when "DOLBII Music" is selected.

Setting range

-3 to 0 to +3

Center Image

Adjusts the center orientation level (broadening effect) of the front sound field. Higher to strengthen the center orientation level (less broadening effect) and lower to weaken (more broadening effect). This setting is effective when "Neo:6 Music" is selected.

Setting range

0.0 to 0.3 to 1.0

Lipsync

Adjusts the delay between video and audio output.



- You can enable/disable the Lipsync function by input sources in "Lipsync" (p.82) in the "Option" menu.

Select

Selects the method to adjust the delay between video and audio output.

Setting range

Manual	Select this option when you want to adjust the delay between video and audio output manually. Adjust the audio output timing in "Adjustment".
Auto	Adjusts the delay between video and audio output automatically when a TV that supports an automatic lipsync function is connected to the unit via HDMI. If necessary, you can fine-adjust the audio output timing in "Adjustment".



- "Select" is automatically set to "Manual" depending on the TV connected to the unit.

Adjustment

Adjusts the delay between video and audio output manually when "Select" is set to "Manual". You can fine-adjust the audio output timing when "Select" is set to "Auto".

Setting range

0 ms to 500 ms (1 ms increments)

Volume

Configures the volume settings.

Scale

Switches the scale of the volume display.

Settings

dB	Displays the volume in the "dB" unit.
0-97	Displays the volume in the numeric value (0.5 to 97.0).

Dynamic Range

Selects the dynamic range adjustment method for bitstream audio (Dolby Digital and DTS signals) playback.

Settings

Maximum	Produces audio without adjusting the dynamic range.
Standard	Optimizes the dynamic range for regular home use.
Min/Auto	Sets the dynamic range for clear sound even at night or at low volumes. When playing back Dolby TrueHD signals, the dynamic range is automatically adjusted based on the input signal information.

Main Zone Max Volume

Sets the main zone maximum volume to prevent excessive loudness.

Setting range

-30.0 dB to +15.0 dB (5.0 dB increments), ±16.5 dB

Main Zone Initial Volume

Sets the main zone initial volume when the unit is turned on.

Settings

Off	Sets the level to the volume level of the unit when it last entered standby mode.
Mute	Sets the unit to mute the audio output.
-80.0 dB to +16.5 dB (0.5 dB increments)	Sets the level to the specified volume level.

Zone2 Max Volume

Sets the Zone2 maximum volume to prevent excessive loudness.

Setting range

-30.0 dB to +15.0 dB (5.0 dB increments), +16.5 dB



- This setting is available only when "Power Amp Assign" (p.88) is set to "Zone2".

Zone2 Initial Volume

Sets the Zone2 initial volume when the Zone2 output is enabled.

Settings

Off	Sets the level at the volume level of the unit when it last entered standby mode.
Mute	Sets the unit to mute the audio output.
-80.0 dB to +16.5 dB (0.5 dB increments)	Sets the level to the specified volume level.



- This setting is available only when "Power Amp Assign" (p.88) is set to "Zone2".

ECO

Configures the power supply settings.



- Default settings are underlined.

■ Auto Power Standby

Set the amount of time for the auto-standby function.

Settings

<u>Off</u>	Does not set the unit to standby mode automatically.
20 minutes	Sets the unit to standby mode when you have not operated the unit and the unit has not detected any input signal for the specified time.
2 hours, 4 hours, 8 hours, 12 hours	Sets the unit to standby mode when you have not operated the unit for the specified time.

Default

U.K., Europe and Russia models: 20 minutes

Other models: Off



- Just before the unit enters standby mode, “AutoPowerStdby” appears and then countdown starts in the front display.

■ ECO Mode

Enables/disables the eco (power saving) mode.

When the eco mode is enabled, you can reduce the unit's power consumption.

Settings

<u>Off</u>	Disables the eco mode.
On	Enables the eco mode.



- Be sure to press ENTER to restart the unit after selecting a setting. The new setting will take effect after the unit is restarted.
- When “ECO Mode” is set to “On”, the front panel display may become dark.
- If you want to play audio at high volume, set “ECO Mode” to “Off”.

Function

Configures the functions that make the unit easier to use.



- Default settings are underlined.

Input Rename

Changes the input source name displayed on the front display. You can also select a name from the presets or a name created by the Auto Rename function.

Input sources

HDMI 1–6, AUDIO 1–3, AV 1–3, USB, Bluetooth, AUX

Default

HDMI 1–6: Auto

Others: Manual (For USB, Bluetooth, AUX only "Manual" can be selected.)

Procedure

- 1 Use the cursor keys (Δ/∇) to select an input source to be renamed.
- 2 Use the cursor keys (\leftarrow/\rightarrow) to select "Manual" and press ENTER.



- To select a name from the presets, after selecting "Manual", use the cursor keys (\leftarrow/\rightarrow) to select a preset name.
- When selecting "Auto", the unit creates a name automatically according to the connected device. You can check a created name by pressing ENTER.
- During selecting "Auto", the created name is saved even after the device connection is terminated. To reset to the default setting, switch the setting to "Manual" at once and then set it again to "Auto".

- 3 Press ENTER.

The edit screen is displayed.



- 4 Use the cursor keys and ENTER key to edit the name, and then select "OK" to confirm the new name.
- 5 To change another input source name, repeat steps 1 to 4.

- 6 To exit from the menu, press SETUP.

Input Skip

Set which input source is skipped when operating the INPUT knob on the front panel. You can select the desired input source quickly by skipping unnecessary input sources.

Input sources

HDMI 1–6, AUDIO 1–3, AV 1–3, TUNER, USB, NET, Bluetooth, AUX

Settings

<u>Off</u>	Does not skip the selected input source.
On	Skips the selected input source.

Dimmer

Adjusts the brightness of the front display.

Setting range

-4 to 0 (higher to brighter)



- The front display may become dark when "ECO Mode" (p.96) is set to "On".

Memory Guard

Prevents accidental changes to the settings.

Settings

<u>Off</u>	Does not protect the settings.
On	Protects the settings until "Off" is selected.



- When "Memory Guard" is set to "On", the lock icon (🔒) is displayed on the menu screen.

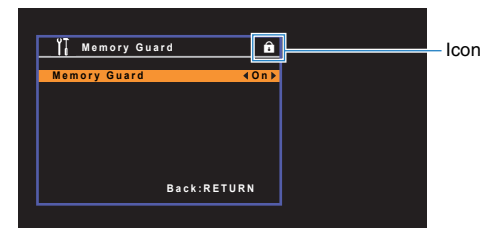

■ Remote Color Key

Set the unit's functions for the RED/GREEN/YELLOW/BLUE key of the remote control.

Settings

<u>Default</u>	Assigns the functions of playback devices connected to the unit with an HDMI cable.
Input	Assigns the unit's input sources to each key. The assigned input sources can be set separately. Input sources HDMI 1-6, AUDIO 1-3, AV 1-3, TUNER, USB, NET, Bluetooth, AUX Default RED: HDMI 2, GREEN: HDMI 6, YELLOW: AV 2, BLUE: AUX
Program	Sound modes are assigned to keys as follows. RED: MOVIE GREEN: MUSIC YELLOW: STEREO BLUE: SUR.DECODE For example, if you press the RED key repeatedly, you can select your favorite sound program from the sound programs (MOVIE) (p.44) suitable for the video source.

■ Party Mode Set

Enables/disables switching to the party mode (p.77).

Settings

Disable	Disables switching to the party mode.
<u>Enable</u>	Enables switching to the party mode. You can turn on/off the party mode by pressing PARTY on the remote control.

Network

Configures the network settings.



- Default settings are underlined.

Information

Displays the network information on the unit.

Status	The connection status of the NETWORK jack
Connection	Connection method
SSID	The access point to which the unit is connected
Security	The encryption method for your network
MAC Address (Ethernet)	MAC address
MAC Address (Wi-Fi)	
IP Address	IP address
Subnet Mask	Subnet mask
Default Gateway	The IP address of the default gateway
DNS Server (P)	The IP address of the primary DNS server
DNS Server (S)	The IP address of the secondary DNS server
vTuner ID	The ID of the Internet radio (vTuner)

Network Connection

Selects the network connection method.

Choices

Wired	Select this option when you want to connect the unit to a network with a commercially-available network cable.
Wireless (Wi-Fi)	Select this option when you want to connect the unit to a network via the wireless router (access point). For details on settings, see "Connecting the unit to a wireless network" (p.32).
Wireless Direct	Select this option when you want to connect a mobile device to the unit directly. For details on settings, see "Connecting a mobile device to the unit directly (Wireless Direct)" (p.39).

IP Address

Configures the network parameters (such as IP address).

DHCP

Select whether to use a DHCP server.

Settings

Off	Does not use a DHCP server. Configure the network parameters manually. For details, see "Manual network settings".
<u>On</u>	Uses a DHCP server to automatically obtain the unit's network parameters (such as IP address).

Manual network settings

- 1 Set "DHCP" to "Off".
- 2 Use the cursor keys (Δ/∇) to select a parameter type.

IP Address	Specifies an IP address.
Subnet Mask	Specifies a subnet mask.
Default Gateway	Specifies the IP address of the default gateway.
DNS Server (P)	Specifies the IP address of the primary DNS server.
DNS Server (S)	Specifies the IP address of the secondary DNS server.

- 3 Use the cursor keys (\langle/\rangle) to move the edit position and the cursor keys (Δ/∇) to select a value.
- 4 To exit from the menu, press SETUP.

■ MAC Address Filter

Sets the MAC address filter to limit access to the unit from other network devices.



- Operation of the AirPlay function (p.64) or the DMC is not limited by this setting.

Filter

Enables/disables the MAC address filter.

Settings

Off	Disables the MAC address filter.
On	Enables the MAC address filter. In "MAC Address 1–10", specify the MAC addresses of the network devices that will be permitted access to the unit.

MAC Address 1–10

Specifies the MAC addresses (up to 10) of the network devices that will be permitted access to the unit when "Filter" is set to "On".

■ Procedure

- 1 Use the cursor keys (Δ/∇) to select an MAC address number (1 to 10).
- 2 Use the cursor keys (\leftarrow/\rightarrow) to move the edit position and the cursor keys (Δ/∇) to select a value.
- 3 To exit from the menu, press **SETUP**.

■ DMC Control

Selects whether to allow DLNA-compatible Digital Media Controller (DMC) to control playback.

Settings

Disable	Does not allow DMCs to control playback.
Enable	Allows DMCs to control playback.



- A Digital Media Controller (DMC) is a device that can control other network devices through the network. When this function is enabled, you can control playback of the unit from DMCs (such as Windows Media Player 12) on the same network.

■ Network Standby

Selects whether the unit can be turned on from other network devices (network standby).

Settings

Off	Disables the network standby function.
On	Enables the network standby function. (The unit consumes more power than when "Off" is selected.)
Auto	Enables the network standby function. (If "Network Connection" is set to "Wired", the unit is set to the power saving mode when the network cable is disconnected.)

■ Network Name

Edits the network name (the unit's name on the network) displayed on other network devices.

■ Procedure

- 1 Press **ENTER** to enter the name edit screen.
- 2 Use the cursor keys and **ENTER** key to edit the name, and then select "**OK**" to confirm the new name.

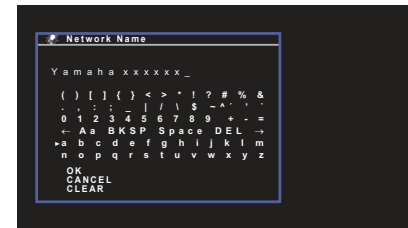

- 3 To exit from the menu, press **SETUP**.

■ Network Update

Updates the firmware via the network.

Perform Update

Starts the process to update the unit's firmware. For details, see "Updating the unit's firmware via the network" (p.106).

Firmware Version

Displays the version of the firmware installed on the unit.

System ID

Displays the system ID number.

Bluetooth

Configures the BLUETOOTH settings.

■ Bluetooth

Enables/disables the BLUETOOTH function (p.60).

Settings

Off	Disables the BLUETOOTH function.
<u>On</u>	Enables the BLUETOOTH function.

■ Bluetooth Standby

Selects whether to enable/disable the function that turns on the unit from BLUETOOTH devices (BLUETOOTH standby). If this function is set to "On", the unit automatically turns on when a connect operation is performed on the BLUETOOTH device.

Settings

Off	Disables the BLUETOOTH standby function.
<u>On</u>	Enables the BLUETOOTH standby function. (The unit consumes more power than when "Off" is selected.)



- This setting is not available when "Network Standby" (p.100) is set to "Off".

Language

Select an on-screen menu language.



- Default settings are underlined.

Settings

<u>English</u>	English
日本語	Japanese
Français	French
Deutsch	German
Español	Spanish
Русский	Russian
Italiano	Italian
中文	Chinese





- Japanese and Chinese characters used in content information (such as song titles) cannot be displayed.
- The information on the front display is provided in English only.

Configuring the system settings (ADVANCED SETUP menu)

Configure the system settings of the unit while viewing the front display.

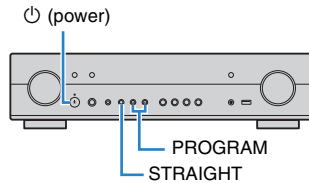
- 1 Set the unit to standby mode.
- 2 While holding down STRAIGHT on the front panel, press  (power).



- 3 Press PROGRAM to select an item.
- 4 Press STRAIGHT to select a setting.
- 5 Press  (power) to set the unit to standby mode and turn it on again.
The new settings take effect.

ADVANCED SETUP menu items



- Default settings are underlined.

Item	Function	Page
SP IMP.	Changes the speaker impedance setting.	103
REMOTE ID	Selects the unit's remote control ID.	104
TU	(Asia and General models only) Changes the FM/AM tuning frequency setting.	104
TV FORMAT	Switches the video signal type of HDMI output.	104
INIT	Restores the default settings.	104
UPDATE	Updates the firmware.	105
VERSION	Checks the version of firmware currently installed on the unit.	105

Changing the speaker impedance setting (SP IMP.)



Change the unit's speaker impedance settings depending on the impedance of the speakers connected.

Settings

<u>6 Ω MIN</u>	Select this option when you connect 6-ohm speakers to the unit.
8 Ω MIN	Select this option when you connect 8-ohm or higher speakers to the unit.

Selecting the remote control ID (REMOTE ID)

REMOTE ID * * ID1

Change the unit's remote control ID so that it matches the remote control's ID (default: ID1). When using multiple Yamaha AV receivers, you can set each remote control with a unique remote control ID for its corresponding receiver.

Settings

ID1, ID2

■ Changing the remote control ID of the remote control

- 1 To select ID1, while holding down the cursor key (◀), hold down SCENE (BD/DVD) for more than 3 seconds.
To select ID2, while holding down the cursor key (◀), hold down SCENE (TV) for more than 3 seconds.**

Changing the FM/AM tuning frequency setting (TU)

(Asia and General models only)

TU * * * FM50/AM9

Change the FM/AM tuning frequency setting of the unit depending on your country or region.

Settings

FM100/AM10	Select this when you want to adjust the FM frequency by 100-kHz steps and AM by 10-kHz steps.
FM50/AM9	Select this when you want to adjust the FM frequency by 50-kHz steps and AM by 9-kHz steps.

Switching the video signal type (TV FORMAT)

TV FORMAT * NTSC

Switch the video signal type of HDMI output so that it matches to the format of your TV. Since the unit automatically selects the video signal type so that it matches to the TV, it is unnecessary to change the setting normally. Change the setting only when images on the TV screen do not appear correctly.

Settings

NTSC, PAL

Default

U.S.A., Canada, Korea and General models: NTSC

Other models: PAL

Restoring the default settings (INIT)

INIT * * * * CANCEL

Restores the default settings for the unit.

Choices

ALL	Restores the default settings for the unit.
<u>CANCEL</u>	Does not perform an initialization.

Updating the firmware (UPDATE)

A black rectangular area representing an LCD display with the text "UPDATE" followed by four dots and "USB" in a white, pixelated font.

New firmware that provides additional features or product improvements will be released as needed. Updates can be downloaded from our website. If the unit is connected to the Internet, you can download the firmware via the network. For details, refer to the information supplied with updates.

■ Firmware update procedure

Do not perform this procedure unless firmware update is necessary. Also, make sure you read the information supplied with updates before updating the firmware.

- 1 Press **STRAIGHT** repeatedly to select “USB” or “NETWORK” and press **INFO (WPS)** to start firmware update.

Choices

USB	Update the firmware using a USB memory device.
NETWORK	Update the firmware via the network.

Checking the firmware version (VERSION)

A black rectangular area representing an LCD display with the text "VERSION" followed by a dot and "xx.xx" in a white, pixelated font.

Check the version of firmware currently installed on the unit.



- You can also check the firmware version in “Network Update” (p.101) in the “Setup” menu.
- It may take a while until the firmware version is displayed.

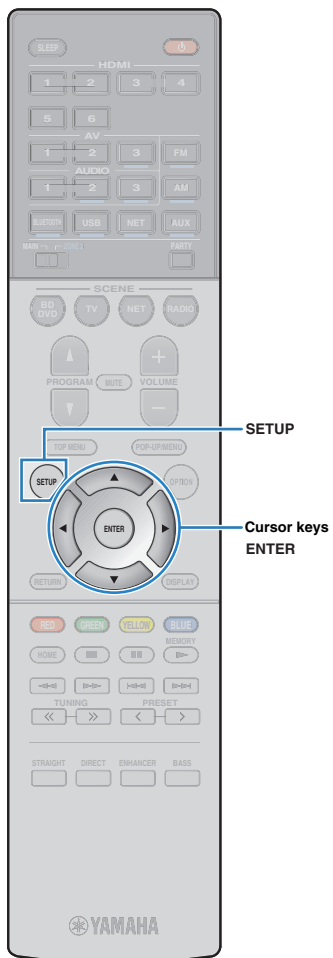

Updating the unit's firmware via the network

New firmware that provides additional features or product improvements will be released as needed. If the unit is connected to the Internet, you can download the firmware via the network and update it.

Note

- Do not operate the unit or disconnect the power cable or network cable during firmware update. Firmware update takes about 20 minutes or more (depending on your Internet connection speed).
- If the Internet connection speed is slow, or the unit is connected to the wireless network, network update may not be possible depending on the condition of the wireless connection. In this case, update the firmware using the USB memory device (p.105).
- To perform the following procedure, your TV must be connected to the unit via HDMI. If not, perform the update from the "ADVANCED SETUP" menu (p.105).
- For details on update, visit the Yamaha website.



- You can also update the firmware using the USB memory device from the "ADVANCED SETUP" menu (p.105).

A firmware update is available if the following message is displayed after SETUP is pressed.

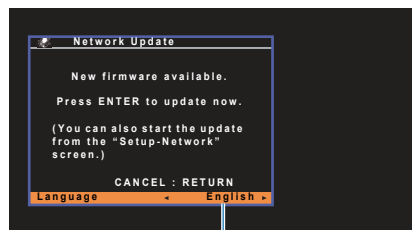

You can switch the language.

- 3 If "UPDATE SUCCESS PLEASE POWER OFF!" appears on the front display, press (power) on the front panel.

The firmware update is complete.

- 1 Read the on-screen description and press ENTER.

- 2 To start the firmware update, press ENTER.

The on-screen display turns off.

APPENDIX

Frequently asked questions

The new speaker system does not provide an ideal sound balance...

If you have changed speakers or have a new speaker system, use YPAO to optimize the speaker settings again (p.27). If you want to adjust the speaker settings manually, use "Speaker" in the "Setup" menu (p.88).

We want to set limitations on the volume control...

If a small child accidentally operates the controls on the main unit or remote control, the volume may suddenly increase. This may also cause injury or damage the unit or speakers. We recommend using "Main Zone Max Volume" and "Zone2 Max Volume" in the "Setup" menu to set the maximum volume level for the unit in advance (p.94).

I want to fix the volume when turning on the unit...

By default, the volume level when the unit last entered standby mode is automatically applied. If you want to fix the volume, use "Main Zone Initial Volume" and "Zone2 Initial Volume" in the "Setup" menu to set the volume to be applied when the receiver is turned on (p.94, 95).

The volume varies depending on the input sources...

You can correct volume differences between input sources by utilizing "Input Trim" in the "Option" menu (p.82).

HDMI Control does not work at all...

To use HDMI Control, you need to perform the HDMI Control link setup (p.122). After connecting HDMI Control-compatible devices (such as BD/DVD players) to the unit, enable HDMI Control on each device and perform the HDMI Control link setup. This setup is required every time you add a new HDMI Control-compatible device to your system. For information on how HDMI Control works between your TV and playback devices, refer to the instruction manuals for each device.

I want to change the input source name...

Input names displayed on the front panel can be changed using "Input Rename" in the setup menu. Change input names by entering names manually, or by selecting preset names (such as "Blu-ray" or "DVD") (p.97).

I want to prevent accidental changes to the settings...

You can protect the settings configured on the unit (such as speaker settings) by utilizing "Memory Guard" in the "Setup" menu (p.97).

The unit's remote control is simultaneously controlling another Yamaha product as well as the unit...

When using multiple Yamaha products, the remote control may work on another Yamaha product or another remote control may work on the unit. If this happens, register different remote control IDs for the devices that you want to control with each remote control (p.104).

I want to enjoy videos/audio played back on the video device even when the unit is in standby mode...

If you have connected a video device to the unit with HDMI, you can output videos/audio played back on the video device to the TV even when the unit is in standby mode. To use this function, set "Standby Through" (p.91) in the "Setup" menu to "On" or "Auto". You can also switch the input source using the remote control of the unit when this function is enabled.

The combination of video/audio input jacks does not match an external device...

Use "Audio In" in the "Option" menu to change the combination of video/audio input jacks so that it matches the output jack(s) of your external device (p.21).

Video and audio are not synchronized...

Use "Lipsync" in the "Setup" menu to adjust the delay between video and audio output (p.94).

I want to hear audio from the TV speakers...

Use "Audio Output" in the "Setup" menu to select the output destination of signals input into the unit (p.91). Your TV speakers may be selected as an output destination.

I want to change the on-screen menu language...

Use "Language" in the "Setup" menu to select a language from English, Japanese, French, German, Spanish, Russian, Italian and Chinese (p.26).

I want to update the firmware...

Use "UPDATE" in the "ADVANCED SETUP" menu to update the unit's firmware (p.105).

I want to customize the unit...

Various functions to customize the unit are available.

- SCENE settings (p.42)
- Sound/video settings and signal information for each source (p.80)
- Various function settings (p.85)
- System settings (p.103)

Troubleshooting

Refer to the table below when the unit does not function properly.

If the problem you are experiencing is not listed below or if the instructions below do not help, turn off the unit, disconnect the power cable, and contact the nearest authorized Yamaha dealer or service center.

First, check the following:

- ① **The power cables of the unit, TV and playback devices (such as BD/DVD players) are connected to AC wall outlets securely.**
- ② **The unit, subwoofer, TV and playback devices (such as BD/DVD players) are turned on.**
- ③ **The connectors of each cable are securely inserted in to jacks on each device.**

Power, system and remote control

Problem	Cause	Remedy
The power does not turn on.	The protection circuitry has been activated three times consecutively. If the unit is in this condition, the standby indicator on the unit blinks when you try to turn on the power.	As a safety precaution, capability to turn on the power is disabled. Contact your nearest Yamaha dealer or service center to request repair.
The power does not turn off.	The internal microcomputer has frozen, due to an external electric shock (such as lightning or excessive static electricity) or to a drop in the power supply voltage.	Hold down \odot (power) on the front panel for more than 15 seconds to initialize and reboot the unit. (If the problem persists, disconnect the power cable from the AC wall outlet and plug it again.)
The power turns off (standby mode) immediately.	The unit was turned on while a speaker cable was shorted.	Twist the bare wires of each speaker cable firmly and reconnect to the unit and speakers (p.16).
The unit enters standby mode automatically.	The sleep timer worked.	Turn on the unit and start playback again.
	The auto-standby function kicked in because the unit was not used for the specified time.	To disable the auto-standby function, set "Auto Power Standby" in the "Setup" menu to "Off" (p.96).
	The speaker impedance setting is incorrect.	Set the speaker impedance to match your speakers (p.103).
The unit is not reacting.	The protection circuitry has been activated because of a short circuit.	Twist the bare wires of each speaker cable firmly and reconnect to the unit and speakers (p.16).
	The internal microcomputer is frozen, due to an external electric shock (such as lightning or excessive static electricity) or to a drop in the power supply voltage.	Hold down \odot (power) on the front panel for more than 15 seconds to initialize and reboot the unit. (If the problem persists, disconnect the power cable from the AC wall outlet and plug it again.)

Problem	Cause	Remedy
The unit cannot be controlled using the remote control.	The unit is out of the operating range.	Use the remote control within the operating range (p.5).
	The batteries are weak.	Replace with new batteries.
	The unit's remote control sensor is exposed to direct sunlight or strong lighting.	Adjust the lighting angle, or reposition the unit.
	The remote control IDs of the unit and the remote control are not identical.	Change the remote control ID of the unit or the remote control (p.104).
	The remote control is set to the Zone2 operation mode.	Set the remote control to the Main zone operation mode (p.75).
An input source cannot be selected using the INPUT knob on the front panel.	The "Input Skip" function has been applied to that input source.	Set the "Input Skip" function in the setup menu (p.97) to "Off" for that input source, or select the input source using the input selection key on the remote control.
The RED/GREEN/YELLOW/BLUE keys of the remote control do not function.	The device which is connected to the unit via HDMI does not support the function of the RED/GREEN/YELLOW/BLUE keys.	Use a device which supports the function of the RED/GREEN/YELLOW/BLUE keys.
	The settings of the RED/GREEN/YELLOW/BLUE keys of the unit's remote control have been changed.	Set the "Remote Color Key" settings in the "Setup" menu to "Default" (p.98).

Audio

Problem	Cause	Remedy
No sound.	Another input source is selected.	Select an appropriate input source with the input selection keys.
	Signals that the unit cannot reproduce are being input.	Some digital audio formats cannot be played back on the unit. To check the audio format of the input signal, use "Signal Info" in the "Option" menu (p.82).
	The cable connecting the unit and playback device is defective.	If there is no problem with the connection, replace with another cable.
The volume cannot be increased.	The maximum volume is set.	Use "Main Zone Max Volume" or "Zone2 Max Volume" in the "Setup" menu to adjust the maximum volume (p.94).
	A device connected to the output jacks of the unit is not turned on. (This may happen due to the nature of AV receivers.)	Turn on all devices connected to the output jacks of the unit.
No sound is coming from a specific speaker.	The playback source does not contain a signal for the channel.	To check it, use "Signal Info" in the "Option" menu (p.82).
	The currently selected sound program/decoder does not use the speaker.	To check it, use "Test Tone" in the "Setup" menu (p.90).
	Audio output of the speaker is disabled.	Perform YPAO (p.27) or use "Configuration" in the "Setup" menu to change the speaker settings (p.88).
	The volume of the speaker is set too low.	Perform YPAO (p.27) or use "Level" in the "Setup" menu to adjust the speaker volume (p.90).
	The speaker cable connecting the unit and the speaker is defective.	If there is no problem with the connection, replace with another speaker cable.
	The speaker is malfunctioning.	To check it, replace with another speaker. If the problem persists, the unit may be malfunctioning.
No sound is coming from the subwoofer.	The playback source does not contain Low Frequency Effect (LFE) or low-frequency signals.	To check it, set "Extra Bass" in the "Setup" menu to "On", in order to output the front channel low-frequency components from the subwoofer (p.89).
	Subwoofer output is disabled.	Perform YPAO (p.27) or set "Subwoofer" in the "Setup" menu to "Use" (p.88).
	The volume of the subwoofer is too low.	Adjust the volume on the subwoofer.
	The subwoofer has been turned off by its auto-standby function.	Disable the auto-standby function of the subwoofer or adjust its sensitivity level.
No sound from the playback device (connected to the unit with HDMI).	The TV does not support HDCP (High-bandwidth Digital Content Protection).	Refer to the instruction manuals for the TV and check the TV's specifications.
	The unit is set not to output audio input through HDMI jacks from the SPEAKERS terminals.	In "Audio Output" in the "Setup" menu, set "Amp" to "On" (p.91).
	The number of devices connected to the HDMI OUT jack exceeds the limit.	Disconnect some of the HDMI devices.

Problem	Cause	Remedy
No sound from the TV (when HDMI Control is used).	The TV is set to output audio from the TV speakers.	Change the audio output setting on your TV so that the TV audio is output from the speakers connected to the unit.
	A TV that does not support ARC is connected to the unit only with an HDMI cable.	Use a digital optical cable to make an audio connection (p.19).
	(If the TV is connected to the unit with an audio cable) The TV audio input setting does not match the actual connection.	Use "TV Audio Input" in the "Setup" menu to select the correct audio input jack (p.91).
	(If you are trying to use ARC) ARC is disabled on the unit or TV.	Set "ARC" in the "Setup" menu to "On" (p.92). Also, enable ARC on the TV.
Only the front speakers work on multichannel audio.	The playback device is set to output 2-channel audio (such as PCM) only.	To check it, use "Signal Info" in the "Option" menu (p.82). If necessary, change the digital audio output setting on the playback device.
DSD audio cannot be heard.	DSD audio is selected as the input source for Zone2.	Enable party mode to play DSD audio in Zone2 (p.77).
Noise/hum is heard.	The unit is too close to another digital or radio frequency device.	Move the unit further away from the device.
	The cable connecting the unit and playback device is defective.	If there is no problem with the connection, replace with another cable.
The sound is distorted.	The volume of the unit is too high.	Turn down the volume. If "ECO Mode" in the "Setup" menu is set to "On", set it to "Off" (p.96).
	A device connected to the unit's output jacks is not turned on.	Turn on all devices connected to the unit's output jacks.

Video

Problem	Cause	Remedy
No video.	Another input source is selected on the unit.	Select an appropriate input source with the input selection keys.
	Another input source is selected on the TV.	Switch the TV input to display the video from the unit.
	The video signal output from the unit is not supported by the TV.	Check the video output setting of the playback device. For information about video signals supported by the TV, refer to the instruction manuals for the TV.
	The cable connecting the unit and TV (or playback device) is defective.	If there is no problem with the connection, replace with another cable.
No video from the playback device (connected to the unit with HDMI).	The input video signal (resolution) is not supported by the unit.	To check the information about the current video signal (resolution), use "Signal Info" in the "Option" menu (p.82). For information about video signals supported by the unit, see "HDMI signal compatibility" (p.124).
	The TV does not support HDCP (High-bandwidth Digital Content Protection).	Refer to the instruction manuals for the TV and check the TV's specifications.
	The number of devices connected to the HDMI OUT jack is over the limit.	Disconnect some of the HDMI devices.
No image (contents required the HDCP 2.2-compatible HDMI device) from the playback device connected to the unit with HDMI.	The TV (HDMI input jack) does not support HDCP 2.2, or the playback device is connected to other than the HDMI 6 jack. (The Warning message can be displayed on the TV screen.)	Connect the unit to the TV (HDMI input jack) that supports HDCP 2.2. Use the HDMI 6 jack to connect the playback device.
The menu of the unit is not displayed on the TV.	The TV is not connected to the unit via HDMI.	You can display the menu of the unit on the TV only when they are connected with an HDMI cable. If necessary, use an HDMI cable to connect them (p.19 to 20).
	Another input source is selected on the TV.	Switch the TV input to display the video from the unit (HDMI OUT jack).

FM/AM radio (AM radio feature is available only on RX-S601.)

Problem	Cause	Remedy
FM radio reception is weak or noisy.	There is multi-path interference.	Adjust the FM antenna height or orientation, or place it in a different location.
	Your area is too far from the FM station transmitter.	Set "FM Mode" in the "Option" menu to "Mono" to select monaural FM radio reception (p.48). Use an outdoor FM antenna.
AM radio reception is weak or noisy.	The noises may be caused by fluorescent lamps, motors, thermostats, or other electrical equipment.	It is difficult to completely eliminate noise. It may be reduced by using an outdoor AM antenna.
Radio stations cannot be selected automatically.	Your area is too far from the FM station transmitter.	Select the station manually (p.48). Use an outdoor antenna. We recommend using a sensitive multi-element antenna.
	The AM radio signal is weak.	Adjust the AM antenna orientation.
		Select the station manually (p.48). Use an outdoor AM antenna.
AM radio stations cannot be registered as presets.	Auto Preset has been used.	Auto Preset is for registering FM radio stations only. Register AM radio stations manually (p.49).

DAB radio (RX-S601D)

Problem	Cause	Remedy
No DAB radio reception.	An initial scan has not been performed.	Perform an initial scan to receive DAB radio (p.52).
No DAB radio reception even after performing an initial scan.	Reception strength of DAB radio is poor.	Check reception strength in "Tune Aid" in the "Option" menu (p.55), and adjust the antenna height or orientation, or place it in a different location.
	There is no DAB coverage in your area.	Check with your dealer or WorldDMB online at " http://www.worlddab.org " for a listing of the DAB coverage in your area.
DAB radio reception is weak or noisy.	There is multi-path interference.	Check reception strength in "Tune Aid" in the "Option" menu (p.55), and adjust the antenna height or orientation, or place it in a different location.
	Your area is too far from the DAB station transmitter.	Use an outdoor antenna. We recommend using a sensitive multi-element antenna.
DAB information is not available or is inaccurate.	The selected DAB radio station may be temporarily out of service or may not provide information.	Contact the DAB broadcaster.
No DAB radio sound.	The selected DAB radio station may be temporarily out of service.	Try the station later or select another station.

USB and network

Problem	Cause	Remedy
The unit does not detect the USB device.	The USB device is not connected to the USB jack securely.	Turn off the unit, reconnect your USB device, and turn the unit on again.
	The file system of the USB device is not FAT16 or FAT32.	Use a USB device with FAT16 or FAT32 format.
Folders and files in the USB device cannot be viewed.	The data in the USB device is protected by the encryption.	Use a USB device without an encryption function.
The network feature does not function.	The network parameters (IP address) have not been obtained properly.	Enable the DHCP server function on your router and set "DHCP" in the "Setup" menu to "On" on the unit (p.99). If you want to configure the network parameters manually, check that you are using an IP address which is not used by other network devices in your network (p.99).
	The media sharing setting is not correct.	Configure the sharing setting and select the unit as a device to which music contents are shared (p.69).
The unit does not detect the PC.	Some security software installed on your PC is blocking the access of the unit to your PC.	Check the settings of security software installed on your PC.
	The unit and PC are not in the same network.	Check the network connections and your router settings, and then connect the unit and the PC to the same network.
	The MAC address filter is enabled on the unit.	In "MAC Address Filter" in the "Setup" menu, disable the MAC address filter or specify the MAC address of your PC to allow it to access to the unit (p.100).
The files in the PC cannot be viewed or played back.	The files are not supported by the unit or the media server.	Use the file format supported by both the unit and the media server. For information about the file formats supported by the unit, see "Playing back music stored on media servers (PCs/NAS)" (p.69).
The Internet radio cannot be played.	The selected Internet radio station is currently not available.	There may be a network problem at the radio station, or the service may have been stopped. Try the station later or select another station.
	The selected Internet radio station is currently broadcasting silence.	Some Internet radio stations broadcast silence at certain of times of the day. Try the station later or select another station.
	Access to the network is restricted by the firewall settings of your network devices (such as the router).	Check the firewall settings of your network devices. The Internet radio can be played only when it passes through the port designated by each radio station. The port number varies depending on the radio station.
The application for smartphone/tablet "AV CONTROLLER" does not detect the unit.	The MAC address filter is enabled on the unit.	In "MAC Address Filter" in the "Setup" menu, disable the MAC address filter or specify the MAC address of your smartphone/tablet to allow it to access to the unit (p.100).
	The unit and smartphone/tablet are not in the same network.	Check the network connections and your router settings, and then connect the unit and smartphone/tablet to the same network.
Firmware update via the network is failed.	It may not be possible depending on the condition of the network.	Update the firmware via the network again or use a USB memory device (p.105).
The mobile device does not recognize the unit when using AirPlay or AV CONTROLLER.	The unit and the mobile device are connected to different SSID when using a multiple SSID router.	Connect them to the Primary SSID (at the top of the list).
The unit cannot connect to the Internet via a wireless router (access point).	The wireless router (access point) is turned off.	Turn on the wireless router.
	The unit and the wireless router (access point) are too far apart.	Place the unit and the wireless router (access point) closer to each other.
	There is an obstacle between the unit and the wireless router (access point).	Move the unit and the wireless router (access point) in a location where there are no obstacles between them.

Problem	Cause	Remedy
Wireless network is not found.	Microwave ovens or other wireless devices in your neighborhood might disturb the wireless communication.	Turn off these devices.
	Access to the network is restricted by the firewall settings of the wireless router (access point).	Check the firewall setting of the wireless router (access point).

Bluetooth

Problem	Cause	Remedy
A Bluetooth connection cannot be established.	The Bluetooth function of the unit is disabled.	Enable the Bluetooth function (p.101).
	Another Bluetooth device is already connected to the unit.	Terminate the current Bluetooth connection and then establish a new connection (p.60).
	The unit and the Bluetooth device are too far apart.	Move the Bluetooth device closer to the unit.
	There is a device (such as microwave oven and wireless LAN) that outputs signals in the 2.4 GHz frequency band nearby.	Move the unit away from those devices.
	The Bluetooth device does not support A2DP.	Use a Bluetooth device that supports A2DP.
	The connection information registered on the Bluetooth device is not working for some reason.	Delete the connection information on the Bluetooth device, and then establish a connection between the Bluetooth device and the unit again (p.60).
No sound is produced, or the sound is interrupted during playback.	The volume of the Bluetooth device is set too low.	Turn up the volume of the Bluetooth device.
	The Bluetooth device is not set to send audio signals to the unit.	Switch the audio output of the Bluetooth device to the unit.
	The Bluetooth connection has been terminated.	Establish a Bluetooth connection between the Bluetooth device and the unit again (p.60).
	The unit and the Bluetooth device are too far apart.	Move the Bluetooth device closer to the unit.
	There is a device (such as microwave oven and wireless LAN) that outputs signals in the 2.4 GHz frequency band nearby.	Move the unit away from those devices.

Error indications on the front display

Message	Cause	Remedy
Access denied	Access to the PC is denied.	Configure the sharing settings and select the unit as a device to which music contents are shared (p.69).
Access error	The unit cannot access the USB device.	Turn off the unit and reconnect your USB device. If the problem persists, try another USB device.
	The unit cannot access the iPod.	Turn off the iPod and turn it on again.
	The connected iPod is not supported by the unit.	Use an iPod supported by the unit (p.61).
	There is a problem with the signal path from the network to the unit.	Make sure your router and modem are turned on. Check the connection between the unit and your router (or hub) (p.24).
Check SP Wires	The speaker cables short circuit.	Twist the bare wires of the cables firmly and connect to the unit and speakers properly.
Internal Error	An internal error has occurred.	Contact the nearest authorized Yamaha dealer or service center.
No content	There are no playable files in the selected folder.	Select a folder that contains files supported by the unit.
No device	The unit cannot detect the USB device.	Turn off the unit and reconnect your USB device. If the problem persists, try another USB device.
	The unit cannot detect the iPod.	Turn off the iPod and then turn it on again.
Not connected	The network cable is not connected.	Connect the network cable properly.
	The wireless router (access point) is not found.	Make sure the wireless router (access point) is turned on.
Please wait	The unit is preparing for connecting to the network.	Wait until the message disappears. If the message stays more than 3 minutes, turn off the unit and turn it on again.
RemID Mismatch	The remote control IDs of the unit and the remote control are not identical.	Change the remote control ID of the unit or the remote control (p.104).
Unable to play	The unit cannot play back the songs stored on the iPod for some reason.	Check the song data. If it cannot be played on the iPod itself, the song data or storage area may be defective.
	The unit cannot play back the songs stored on the PC for some reason.	Check if the format of files you are trying to play is supported by the unit. For information about the formats supported by the unit, see "Playing back music stored on media servers (PCs/NAS)" (p.69). If the unit supports the file format, but still cannot play back any files, the network may be overloaded with heavy traffic.
USB Overloaded	An overcurrent is flowing through the USB device.	Turn off the unit and reconnect your USB device. If the problem persists, try another USB device.
Version error	Firmware update is failed.	Update the firmware again.

Audio information

■ Audio decoding format

Dolby Digital

Dolby Digital is a compressed digital audio format developed by Dolby Laboratories, Inc. that supports 5.1-channel audio. This technology is used for audio on most DVD disc.

Dolby Digital Plus

Dolby Digital Plus is a compressed digital audio format developed by Dolby Laboratories, Inc. that supports 7.1-channel audio. Dolby Digital Plus remains fully compatible with the existing multichannel audio systems that support Dolby Digital. This technology is used for audio on BD (Blu-ray Disc).

Dolby Pro Logic II

Dolby Pro Logic II enables 5-channel playback from 2-channel sources. There are three modes available: "Music mode" for music sources, "Movie mode" for movie sources, and "Game mode" for game sources.

Dolby TrueHD

Dolby TrueHD is an advanced lossless audio format developed by Dolby Laboratories, Inc. to offer a high-definition home theater experience with the quality of the studio master. Dolby TrueHD can carry up to eight channels of 96 kHz/24-bit audio (up to six channels of 192 kHz/24-bit audio) simultaneously. This technology is used for audio on BD (Blu-ray Disc).

DTS 96/24

DTS 96/24 is a compressed digital audio format that supports 5.1-channel and 96 kHz/24-bit audio. This format remains fully compatible with the existing multichannel audio systems that support DTS Digital Surround. This technology is used for music DVDs, etc.

DTS Digital Surround

DTS Digital Surround is a compressed digital audio format developed by DTS, Inc. that supports 5.1-channel audio. This technology is used for audio on most DVD discs.

DTS-ES

DTS-ES creates total 6.1-channel audio from 5.1-channel sources that are recorded with DTS-ES. This decoder adds a surround back sound to the original 5.1-channel sound. In the DTS-ES Matrix 6.1 format, a surround back sound is recorded in the surround channels, and in the DTS-ES Discrete 6.1 format, a discrete surround back channel is recorded.

DTS Express

DTS Express is a compressed digital audio format that supports 5.1-channel audio and allows a higher compression rate than the DTS Digital Surround format developed by DTS, Inc. This technology is developed for audio streaming services on the Internet and secondary audio on BD (Blu-ray Disc).

DTS-HD High Resolution Audio

DTS-HD High Resolution Audio is a compressed digital audio format developed by DTS, Inc. that supports 7.1-channel and 96 kHz/24-bit audio. DTS-HD High Resolution Audio remains fully compatible with the existing multichannel audio systems that support DTS Digital Surround. This technology is used for audio on BD (Blu-ray Disc).

DTS-HD Master Audio

DTS-HD Master Audio is an advanced lossless audio format developed to offer a high-definition home theater experience with the quality of the studio master by DTS, Inc. DTS-HD Master Audio can carry up to eight channels of 96 kHz/24-bit audio (up to six channels of 192 kHz/24-bit audio) simultaneously. This technology is used for audio on BD (Blu-ray Disc).

DTS Neo: 6

DTS Neo: 6 enables 6-channel playback from 2-channel sources. There are two modes available: "Music mode" for music sources and "Cinema mode" for movie sources. This technology provides discrete full-bandwidth matrix channels of surround sound.

DSD (Direct Stream Digital)

DSD (Direct Stream Digital) technology stores audio signals on digital storage media, such as SACD (Super Audio CDs). The signals are stored at a high-frequency sampling rate of 2.8224 MHz. The highest frequency response is equal to or higher than 100 kHz, with a dynamic range of 120 dB. This technology offers better audio quality than that used for CDs.

FLAC

FLAC is a file format for lossless audio data compression. FLAC is inferior to lossy compressed audio formats in compression rate but provides higher audio quality.

MP3

One of the compressed digital audio format used by MPEG. With psychoacoustic technologies, this compression method achieves a high compression rate. Reportedly, it is capable of compressing data quantity by about 1/10 maintaining a certain level of audio quality.

MPEG-4 AAC

An MPEG-4 audio standard. It is used for mobile telephones, portable audio players, and audio streaming services on Internet because it allows a high compression rate of data while maintaining better audio quality than MP3.

PCM (Pulse Code Modulation)

PCM is a signal format under which an analog audio signal is digitized, recorded, and transmitted. This technology is the basis of all other audio format. This technology is used as a lossless audio format called Linear PCM for audio on a variety of media, including CDs and BD (Blu-ray Disc).

Sampling frequency/Quantization bit

Sampling frequency and quantization bits indicate the quantity of information when an analog audio signal is digitized. These values are noted as in the following example: "48 kHz/24-bit".

- **Sampling frequency**
Sampling frequency (the number of times the signal is sampled per second) is called the sampling rate. When the sampling frequency is higher, the range of frequencies that can be played back are wider.
- **Quantization bit**
The number of quantization bits indicate the degree of accuracy when converting the sound level into a numeric value. When the number of quantized bits is higher, the expression of the sound level is more accurate.

WAV

Windows standard audio file format, which defines the method of recording the digital data obtained by converting audio signals. By default, the PCM method (no compression) is used, but you can also use other compression methods.

WMA (Windows Media Audio)

One of the compressed digital audio formats developed by Microsoft Corporation. With psychoacoustic technologies, this compression method achieves a high compression rate. Reportedly, it is capable of compressing data quantity by about 1/20 maintaining a certain level of audio quality.

Others

Bi-amplification connection (Bi-amp)

A bi-amplification connection uses two amplifiers for a speaker. When you use the bi-amplification connection, the unit drives the tweeter and woofer in a speaker with the discrete amplifiers. As a consequence, the tweeter and woofer provide clear audio signal without the interference.

LFE (Low Frequency Effects) 0.1 channel

This channel reproduces low-frequency bass signals and has a frequency range from 20 Hz to 120 Hz. This channel is added to the channels for all bands with Dolby Digital or DTS to enhance low frequency audio effects. This channel is labeled 0.1 because it is limited to only low frequency audio.

Lip sync

Video output sometimes lags behind audio output due to the complexity of signal processing caused by an increase in video signal capacity. Lip sync is a technique for automatically correcting the timing lag between audio and video output.

HDMI and video information

Component video signal

With the component video signal system, the video signal is separated into the Y signal for luminance and the Pb and Pr signals for chrominance. Color can be reproduced more faithfully with this system because each of these signals is independent.

Composite video signal

With the composite video signal system, color, brightness, and synchronization data signals are combined and transmitted with a single cable.

Deep Color

Deep Color is a technology that HDMI specification supports. Deep Color increases the number of available colors within the boundaries defined by the RGB or YCbCr color space. Conventional color systems process the color using 8 bits. Deep Color processes the color with 10, 12, or 16 bits. This technology allows HDTVs and other displays to increase from millions of colors to billions of colors and eliminate on-screen color banding for smooth tonal transitions and subtle gradations between colors.

HDMI

HDMI (High-Definition Multimedia Interface) is the world-wide standard interface for digital audio/video signal transmission. This interface transmits both digital audio and digital video signals using a single cable without any loss. HDMI complies with HDCP (High-bandwidth Digital Content Protection) and provides a secure audio/video interface. For further information on HDMI, visit the HDMI website at "<http://www.hdmi.org/>".

x.v.Color

"x.v.Color" is a technology that the HDMI specification supports. It is a more extensive color space than sRGB and allows the expression of colors that were not hitherto possible. While remaining compatible with the color gamut of sRGB standards, "x.v.Color" expands the color space, and thus can produce more vivid, natural images.

Network information

SSID

SSID (Service Set Identifier) is a name that identifies a particular wireless LAN access point.

Wi-Fi

Wi-Fi (Wireless Fidelity) is a technology that allows an electronic device to exchange data or connect to the Internet wirelessly using radio waves. Wi-Fi offers the advantage of eliminating the complexity of making connections with LAN cables by using wireless connection. Only products that complete Wi-Fi Alliance interoperability tests can carry the "Wi-Fi Certified" trademark.

WPS

WPS (Wi-Fi Protected Setup) is a standard established by the Wi-Fi Alliance, which allows easy establishment of a wireless home network.

Yamaha technologies

CINEMA DSP (Digital Sound Field Processor)

Since the Dolby Surround and DTS systems were originally designed for use in movie theaters, their effect is best experienced in a theater that has many speakers designed for acoustic effects. Since home conditions (such as room size, wall material, and number of speakers) can differ so widely, it is inevitable that there are differences in the sound that you hear. Based on a wealth of actually measured data, CINEMA DSP, Yamaha's original DSP technology provides the audiovisual experience of a movie theater in your own home.

CINEMA DSP 3D

The actually measured sound field data contain the information of the height of the sound images. CINEMA DSP 3D mode achieves the reproduction of the accurate height of the sound images so that it creates the accurate and intensive 3D sound fields in a listening room.

Compressed Music Enhancer

The Compressed Music Enhancer feature compensates for missing harmonics in compression music formats (such as MP3). As a result, this technology provides improved performance for the overall sound system.

SILENT CINEMA

Yamaha has developed a natural, realistic sound effect DSP algorithm for headphones. Parameters for headphones have been set for each sound program, so that accurate representations of all the sound programs can be enjoyed on headphones.

Virtual CINEMA DSP

Virtual CINEMA DSP allows the system to virtually reproduce the sound field of the surround speakers with front left and right speakers. Even if the surround speakers are not connected, the unit creates the realistic sound field in a listening room.

Virtual Presence Speaker (VPS)

Virtual Presence Speaker allows the system to virtually reproduce the height of the 3D sound field without front presence speakers. Even if the front presence speakers are not connected, the unit creates the 3D sound field in your room.

YPAO (Yamaha Parametric room Acoustic Optimizer)

The Yamaha Parametric room Acoustic Optimizer (YPAO) function detects speaker connections, measures the distances from them to your listening position(s), and then automatically optimizes the speaker settings, such as volume balance and acoustic parameters, to suit your room.

Supported devices and file formats

Supported devices

BLUETOOTH devices

- BLUETOOTH devices that support A2DP can be used.
- Yamaha does not assure the connections of all BLUETOOTH devices.

USB devices

- This unit supports USB mass storage class devices (e.g., flash memories or portable audio players) using FAT16 or FAT32 format.
- Do not connect devices other than USB mass storage class devices (such as USB chargers or USB hubs), PCs, card readers, an external HDD, etc.
- USB devices with encryption cannot be used.
- Some features may not be compatible, depending on the model or manufacturer of the USB storage device.

iPod

Made for.

iPhone 6 Plus, iPhone 6, iPhone 5s, iPhone 5c, iPhone 5, iPhone 4s, iPhone 4, iPhone 3GS, iPhone 3G
iPod touch (2nd, 3rd, 4th and 5th generation)
iPod nano (2nd, 3rd, 4th, 5th, 6th and 7th generation)
(as of July 2015)

- An iPod may not be detected by the unit or some features may not be compatible, depending on the model or software version of the iPod.

AirPlay

AirPlay works with iPhone, iPad, and iPod touch with iOS 4.3.3 or later, Mac with OS X Mountain Lion or later and Mac and PC with iTunes 10.2.2 or later.
(as of July 2015)

■ File formats

□ USB, PC/NAS

File	Sampling frequency (kHz)	quantization bit (bit)	Bitrate (kbps)	Number of channels	Support for gapless playback
WAV *	32/44.1/48/ 88.2/96/ 176.4/192	16/24	-	2	✓
MP3	32/44.1/48	-	8 to 320	2	-
WMA	32/44.1/48	-	8 to 320	2	-
MPEG-4 AAC	32/44.1/48	-	8 to 320	2	-
FLAC	32/44.1/48/ 88.2/96/ 176.4/192	16/24	-	2	✓
ALAC	32/44.1/48/ 88.2/96	16/24	-	2	✓
AIFF	32/44.1/48/ 88.2/96/ 176.4/192	16/24	-	2	✓
DSD	2.8 MHz/ 5.6 MHz	1	-	2	-

* Linear PCM format only

- To play back FLAC files stored on your PC/NAS, you need to install server software that supports sharing of FLAC files via DLNA on your PC or use a NAS that supports FLAC files.
- Digital Rights Management (DRM) contents cannot be played back.

Video signal flow

Video signals input from a video device to the unit are output to a TV as shown below.

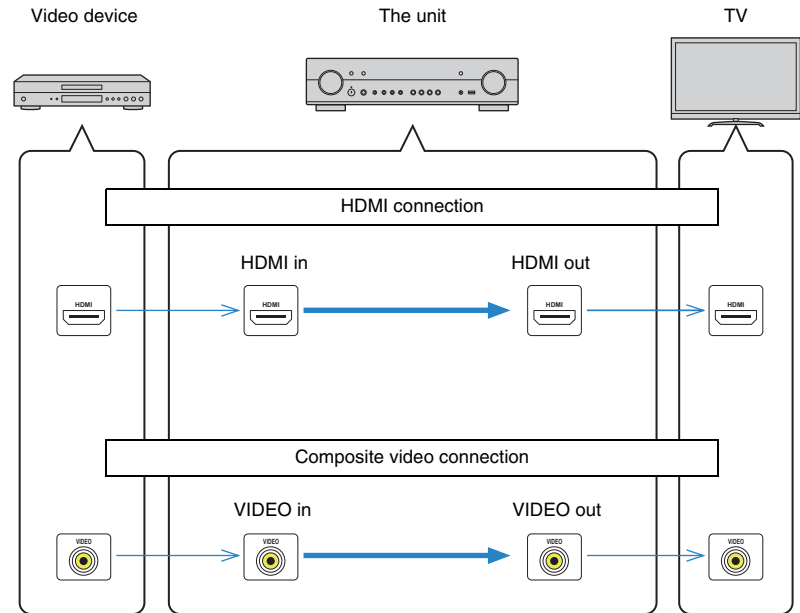

Information on HDMI

HDMI Control

HDMI Control allows you to operate external devices via HDMI. If you connect a TV that supports HDMI Control to the unit with an HDMI cable, you can control the unit (such as power and volume) with TV remote control operations. You can also control playback devices (such as HDMI Control-compatible BD/DVD players) connected to the unit with an HDMI cable.

Operations available from the TV's remote control

- Standby synchronization
- Volume control including mute
- Switching to input audio from the TV when the TV input is switched to its built-in tuner
- Switching to input video/audio from the selected playback device
- Switching between audio output devices (the unit or TV speaker)

(Example)

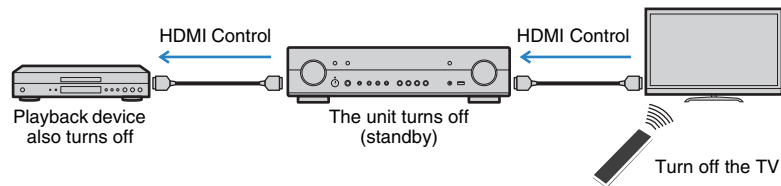

Operations available from the unit's remote control

- Starting playback on the playback device and turning on the TV with a scene selection (p.42)
- Switching the TV input to display the "Setup" menu (when SETUP is pressed)
- Controlling the playback device (playback and menu operations)

(Example)

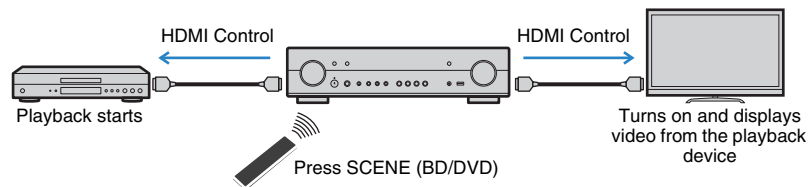

To use HDMI Control, you need to perform the following HDMI Control link setup after connecting the TV and playback devices.

For details on settings and operating your TV, refer to the instruction manual for the TV.



- This setup is required every time you add a new HDMI Control-compatible device to your system.

1 Turn on the unit, TV, and playback devices.

2 Configure the settings of the unit.

- ① Switch the TV input to display video from the unit.
- ② Press SETUP.

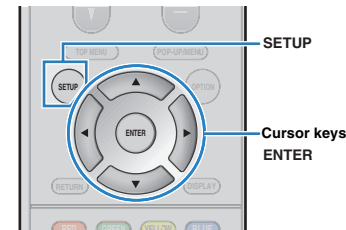

- ③ Use the cursor keys to select "HDMI" and press ENTER.

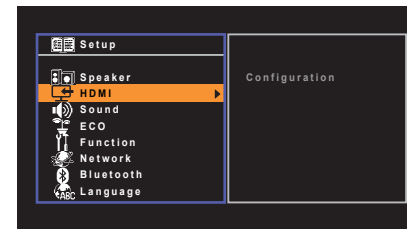

- ④ Press ENTER again.

- ⑤ Use the cursor keys (△/▽) to select “HDMI Control” and the cursor keys (◀/▶) to select “On” as shown below.

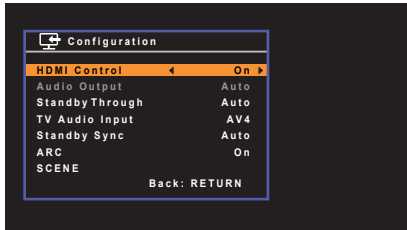

- ⑥ If you made a digital optical cable connection between the TV and the unit, use the cursor keys (△/▽) to select “TV Audio Input” and the cursor keys (◀/▶) to select “AV 1”.

- ⑦ Press SETUP.

3 Enable HDMI Control on the TV and playback devices (such as HDMI Control-compatible BD/DVD players).

4 Turn off the main power of the TV and then turn off the unit and playback devices.

5 Turn on the unit and playback devices and then turn on the TV.

6 Switch the TV input to display the video from the unit.

7 Check the followings.

On the unit: The input to which the playback device is connected is selected. If not, select the input source manually.

On the TV: The video from the playback device is displayed.

8 Check that the unit is properly synchronized with the TV by turning off the TV or adjusting the TV volume with the TV remote control.



- If HDMI Control does not work properly, try unplugging the TV in Step 2 and plugging in the TV again in Step 3. It may solve the problem. Also, HDMI Control may not work if the number of connected devices exceeds the limit. In this case, disable HDMI Control on the devices not in use.
- If the unit is not synchronized to the TV's power operations, check the priority of the audio output setting on the TV.
- If you reconnect the HDMI cable, perform the procedure 5-8 again.
- We recommend using TV and playback devices from the same manufacturer so that HDMI Control works more effectively.

Audio Return Channel (ARC)

ARC allows you to input TV audio to the unit with the HDMI cable which transmits video signal to the TV.

Check the following after the HDMI Control settings.

1 Select a TV program with the TV remote control.

2 Check that the input source of the unit will be automatically switched to “AV 1” and the TV audio will be played back on the unit.

If you cannot hear the TV audio, check the following:

- “ARC” (p.92) in the “Setup” menu is set to “On”.
- The HDMI cable is connected to the ARC-compatible HDMI jack (HDMI jack marked “ARC”) on the TV.

Some HDMI jack on the TV is not compatible with ARC. For details, refer to the instruction manual for the TV.



- If the audio is interrupted while using ARC, set “ARC” (p.92) in the “Setup” menu to “Off” and use a digital optical cable to input TV audio to the unit (p.19).
- When using ARC, connect a TV with an HDMI cable that supports ARC.



- “AV 1” is set as TV audio input at the factory. If you have connected any external device to the AV 4 jacks, use “TV Audio Input” (p.91) in the “Setup” menu to change the TV audio input assignment. To use the SCENE function (p.42), you also need to change the input assignment for SCENE (TV).

HDMI signal compatibility

Audio signals

Audio signal type	Audio signal format	Compatible media (example)
2ch Linear PCM	2ch, 32 to 192 kHz, 16/20/24 bit	CD, DVD-Video, DVD-Audio
Multichannel Linear PCM	8ch, 32 to 192 kHz, 16/20/24 bit	DVD-Audio, BD (Blu-ray disc), HD DVD
DSD	2 to 5.1ch, 2.8224 MHz, 1 bit	SACD
Bitstream	Dolby Digital, DTS	DVD-Video
Bitstream (High definition audio)	Dolby TrueHD, Dolby Digital Plus, DTS-HD Master Audio, DTS-HD High Resolution Audio, DTS Express	BD (Blu-ray disc), HD DVD

Video signals

The unit is compatible with the video signals of the following resolutions:

- VGA
- 720p/60 Hz, 50 Hz
- 480i/60 Hz
- 1080i/60 Hz, 50 Hz
- 576i/50 Hz
- 1080p/60 Hz, 50 Hz, 30 Hz, 25 Hz, 24 Hz
- 480p/60 Hz
- 4K/30 Hz, 25 Hz, 24 Hz
- 576p/50 Hz
- 4K/60Hz (YCbCr4:2:0), 50Hz (YCbCr4:2:0)



- When CPPM copy-protected DVD-Audio is played back, video/audio signals may not be output, depending on the type of the DVD player.
- The unit is not compatible with HDCP-incompatible HDMI or DVI devices. For details, refer to the instruction manual for each device.
- To decode audio bitstream signals on the unit, set the input source device appropriately so that the device outputs the bitstream audio signals directly (does not decode the bitstream signals on the playback device). For details, refer to the instruction manual for the playback device.

Trademarks



Manufactured under license from Dolby Laboratories. Dolby, Pro Logic and the double-D symbol are trademarks of Dolby Laboratories.



For DTS patents, see <http://patents.dts.com>. Manufactured under license from DTS Licensing Limited. DTS, DTS-HD, the Symbol, & DTS and the Symbol together are registered trademarks of DTS, Inc. © DTS, Inc. All Rights Reserved.



"Made for iPod" and "Made for iPhone" mean that an electronic accessory has been designed to connect specifically to iPod or iPhone, respectively, and has been certified by the developer to meet Apple performance standards. Apple is not responsible for the operation of this device or its compliance with safety and regulatory standards. Please note that the use of this accessory with iPod or iPhone may affect wireless performance. iTunes, AirPlay, iPad, iPhone, iPod, iPod classic, iPod nano, and iPod touch are trademarks of Apple Inc., registered in the U.S. and other countries. iPad, iPhone, and iPod touch are trademarks of Apple Inc., registered in the U.S. and other countries. App Store is a service mark of Apple Inc.



This receiver supports network connections.



HDMI, the HDMI Logo, and High-Definition Multimedia Interface are trademarks or registered trademarks of HDMI Licensing LLC in the United States and other countries.

x.v.Color™

"x.v.Color" is a trademark of Sony Corporation.



DLNA™ and DLNA CERTIFIED™ are trademarks or registered trademarks of Digital Living Network Alliance. All rights reserved. Unauthorized use is strictly prohibited.

Windows™

Windows is a registered trademark of Microsoft Corporation in the United States and other countries.

Internet Explorer, Windows Media Audio and Windows Media Player are either registered trademarks or trademarks of Microsoft Corporation in the United States and/or other countries.

Android™

Google Play™

Android and Google Play are trademarks of Google Inc.



The Wi-Fi CERTIFIED™ Logo is a certification mark of Wi-Fi Alliance®.

The Wi-Fi Protected Setup™ Identifier Mark is a certification mark of Wi-Fi Alliance®.



The Bluetooth® word mark and logos are registered trademarks owned by Bluetooth SIG, Inc. and any use of such marks by Yamaha Corporation is under license.

Bluetooth protocol stack (Blue SDK)

Copyright 1999-2014 OpenSynergy GmbH

All rights reserved. All unpublished rights reserved.



(For RX-S601D)

The unit supports DAB/DAB+ tuning.

SILENT™ CINEMA

"SILENT CINEMA" is a trademark of Yamaha Corporation.

Explanations regarding GPL

This product utilizes GPL/LGPL open-source software in some sections. You have the right to obtain, duplicate, modify, and redistribute this open-source code only. For information on GPL/LGPL open source software, how to obtain it, and the GPL/LGPL license, refer to the Yamaha Corporation website (<http://download.yamaha.com/sourcecodes/musiccast/>).

Specifications

Input jacks

- Analog Audio
Audio x 4
- Digital Audio (Supported frequencies: 32 kHz to 96 kHz)
Optical x 1
Coaxial x 2
- Video
Composite x 3
- HDMI Input
HDMI x 6
- Other jacks
 - USB x 1 (USB2.0)
 - NETWORK (Wired) x 1 (100Base-TX/10Base-T)
 - NETWORK (Wireless) x 1 (IEEE802.11b/g/n)

Output jacks

- Analog Audio
 - Speaker Out x 5 (FRONT L/R, CENTER, SURROUND L/R)
 - Subwoofer Out x 1
 - Headphone x 1
- Video
Composite x 1
- HDMI Output
HDMI OUT x 1

Other jacks

- YPAO MIC x 1

HDMI

- HDMI Features: Deep Color, "x.v.Color," Auto Lip Sync, ARC (Audio Return Channel), 3D, 4K Ultra HD
- Video Format (Repeater Mode)
 - VGA
 - 480i/60 Hz
 - 576i/50 Hz
 - 480p/60 Hz
 - 576p/50 Hz
 - 720p/60 Hz, 50 Hz
 - 1080i/60 Hz, 50 Hz
 - 1080p/60 Hz, 50 Hz, 30 Hz, 25 Hz, 24 Hz
 - 4K/30 Hz, 25 Hz, 24 Hz
- Audio Format
 - Dolby TrueHD
 - Dolby Digital Plus
 - Dolby Digital
 - DTS-HD Master Audio
 - DTS-HD High Resolution Audio
 - DTS Express
 - DTS
 - DSD 2-ch to 6-ch
 - PCM 2-ch to 8-ch (Max. 192 kHz/24-bit)
- Content Protection: HDCP compatible (HDMI 6 jack: HDCP 2.2 compatible)
- Link Function: CEC supported

TUNER

- Analog Tuner
[RX-S601 U.K. and Europe models]
FM/AM with Radio Data System x 1 (TUNER)
[RX-S601 other models]
FM/AM x 1 (TUNER)
[RX-S601D U.K. and Europe models]
DAB/FM with Radio Data System x 1 (TUNER)
[RX-S601D other models]
DAB/FM x 1 (TUNER)

USB

- Capable of iPod, Mass Storage Class USB Memory
- Current Supply Capacity: 1.0 A

BLUETOOTH

BLUETOOTH version Ver. 2.1+EDR
Supported profile A2DP, AVRCP
Supported codec SBC, AAC
Wireless output BLUETOOTH Class 2
Maximum communication distance
..... 10 m (33 ft) without interference

Network

- PC Client Function
- Compatible with DLNA ver. 1.5
- AirPlay supported
- Internet Radio
- Wi-Fi function
 - Capable of WPS by PIN Method and Push-Button-Method
 - Capable of sharing with iOS devices by wireless connection and USB connection
 - Capable of Direct Connection with Mobile Device
 - Available Security Method: WEP, WPA2-PSK (AES), Mixed Mode
 - Radio Frequency Band: 2.4GHz
 - Wireless Network Standard: IEEE 802.11 b/g/n

Compatible Decoding Formats

- Decoding Format
 - Dolby TrueHD, Dolby Digital Plus
 - Dolby Digital
 - DTS-HD Master Audio, DTS-HD High Resolution Audio, DTS Express
 - DTS, DTS 96/24, DTS-ES Matrix 6.1, DTS-ES Discrete 6.1
- Post Decoding Format
 - Dolby Pro Logic
 - Dolby Pro Logic II Music, Dolby Pro Logic II Movie, Dolby Pro Logic II Game
 - DTS Neo: 6 Music, DTS Neo: 6 Cinema

Audio Section

- Rated Output Power (2-channel driven)
(20 Hz to 20 kHz, 0.09% THD, 6 Ω)
Front L/R60 W+60 W
(20 Hz to 20 kHz, 0.09% THD, 8 Ω)
Front L/R55 W+55 W
(1 kHz, 0.9% THD, 6 Ω)
Front L/R80 W+80 W
Center 80 W
Surround L/R.....80 W+80 W
(1 kHz, 0.9% THD, 8 Ω)
Front L/R65 W+65 W
Center 65 W
Surround L/R.....65 W+65 W
- Rated Output Power (1-channel driven)
(1 kHz, 0.9% THD, 6 Ω)
Front L/R95 W/ch
Center 95 W/ch
Surround95 W/ch
(1 kHz, 0.9% THD, 8 Ω)
Front L/R 80 W/ch
Center 80 W/ch
Surround L/R..... 80 W/ch

- Maximum Effective Output Power (1-channel driven)
(1 kHz, 10% THD, 8 Ω)
Front L/R100 W/ch
Center100 W/ch
Surround L/R100 W/ch
(1 kHz, 10% THD, 6 Ω)
Front L/R125 W/ch
Center125 W/ch
Surround L/R125 W/ch
- Dynamic Power (IHF)
Front L/R (8/6/4/2 Ω).....90/110/140/160 W
- Input Sensitivity / Input Impedance
AV 3 etc. (1 kHz, 100 W/6 Ω)..... 200 mV/47 kΩ
- Maximum Input Signal
AV 3 etc. (1 kHz, 0.5% THD, Effect On)2.3 V
- Output Level / Output Impedance
SUBWOOFER 1 V/1.2 kΩ
- Headphone Jack Rated Output / Impedance
AV 3 etc. (1 kHz, 50 mV, 8 Ω) 100 mV/470 Ω
- Frequency Response
AV 3 etc. to Front (10 Hz to 100 kHz) +0/-3 dB
- Signal to Noise Ratio (IHF-A Network)
AV 3 etc. (DIRECT) (Input 1 kΩ Shorted, Speaker Out)
..... 108 dB or more
- Residual Noise (IHF-A Network)
Front L/R (Speaker Out) 150 μV or less
- Channel Separation
AV 3 etc. (Input 1 kΩ Shorted, 1 kHz/10 kHz)
..... 70 dB/50 dB or more
- Volume Control
Range MUTE, -80 dB to +16.5 dB
Step 0.5 dB
- Tone Control Characteristics
Bass Boost/Cut ±6 dB/0.5 dB Step at 50 Hz
Bass Turnover 350 Hz
Treble Boost/Cut ±6 dB/0.5 dB Step at 20 kHz
Treble Turnover3.5 kHz

- Filter Characteristics
($f_c=40/60/80/90/100/110/120/160/200$ Hz)
H.P.F. (Front, Center, Surround).....12 dB/oct.
L.P.F. (Subwoofer)24 dB/oct.

Video Section

- Video Signal Type
[U.S.A., Canada, Korea and General models] NTSC
[Other models] PAL
- Video Signal Level
Composite 1 Vp-p/75 Ω
- Video Maximum Input Level 1.5 Vp-p or more
- Video Signal to Noise Ratio 50 dB or more

FM Section

- Tuning Range
[U.S.A. and Canada models] 87.5 MHz to 107.9 MHz
[Asia and General models] 87.5/87.50 MHz to 108.0/108.00 MHz
[Other models] 87.50 MHz to 108.00 MHz
- 50 dB Quiet Sensitivity (IHF, 1 kHz, 100% MOD.)
Mono 3 μ V (20.8 dBf)
- Signal to Noise Ratio (IHF)
Mono 65 dB
Stereo 64 dB
- Harmonic Distortion (IHF, 1 kHz)
Mono 0.5%
Stereo 0.6%
- Antenna Input 75 Ω unbalanced

AM section (RX-S601)

- Tuning Range
[U.S.A. and Canada models] 530 kHz to 1710 kHz
[Asia and General models] 530/531 kHz to 1710/1611 kHz
[Other models] 531 kHz to 1611 kHz

DAB Section (RX-S601D)

- Tuning Range 174 MHz to 240 MHz (Band III)
- Support Audio Format
..... MPEG 1 Layer II/MPEG 4 HE AAC v2 (AAC+)
- Antenna 75 Ω unbalanced

General

- Power Supply
[U.S.A. and Canada models] AC 120 V, 60 Hz
[General model] AC 110 to 120/220 to 240 V, 50/60 Hz
[China model] AC 220 V, 50 Hz
[Korea model] AC 220 V, 60 Hz
[Australia model] AC 240 V, 50 Hz
[U.K. and Europe models] AC 230 V, 50 Hz
[Asia model] AC 220 to 240 V, 50/60 Hz
- Power Consumption
[China and Asia models] 170 W
[Other models] 190 W
- Standby Power Consumption
HDMI Control Off, Standby Through Off, Network Standby Off 0.1 W
HDMI Control On, Standby Through On (No Signals),
Network Standby Off 1.4 W
HDMI Control Off, Standby Through Off, Network Standby On,
Bluetooth Standby Off 1.7 W
Wired 1.7 W
Wireless (Wi-Fi) 1.9 W
Wireless Direct 1.9 W
HDMI Control Off, Standby Through Off, Network Standby On
(Wired), Bluetooth Standby On 1.7 W
HDMI Control On, Standby Through On (No Signals),
Network Standby On (Wireless Direct), Bluetooth Standby On 2.9 W
- Maximum Power Consumption
[Asia and General models] 400 W
- Dimensions (W x H x D)
..... 435 x 111 x 327 mm (17-1/8" x 4-3/8" x 12-7/8")
- Reference Dimensions (with wireless antenna upright)
..... 435 x 176 x 327 mm (17-1/8" x 6-7/8" x 12-7/8")
* Including legs and protrusions
- Weight 7.8 kg (17.2 lbs)

* Specifications are subject to change without notice.

Index

Symbols

Envelope icon (✉) 84

Lock icon (🔒) 97

Numerics

2.1-channel system 14

2ch Stereo 45

4K Ultra HD 18

5.1-channel system 14, 16

A

Adaptive DRC 81

ADVANCED SETUP 103

AirPlay 64

AM antenna connection 23

AM radio 48

ARC (Audio Return Channel) 92, 123

Audio Decoder (front display information) 79

Audio Mode (DAB) 54

Auto Power Standby 96

Auto Preset (FM radio) 49

AUX jack 8

B

Banana plug 16

Bi-amp 17, 88

Bluetooth 60

Bookmark 74

C

CINEMA DSP 44

Clear Preset (DAB radio, Option menu) 54

Clear Preset (FM radio, Option menu) 58

Compressed Music Enhancer 47

Crossover 27, 89

D

DAB (Digital Audio Broadcasting) 52

DAB information 54

DAB/FM antenna connection 23

Decoder Off (front display information) 79

Dimmer (Front Display) 97

DIRECT 47

DLNA 71

DLS (Dynamic Label Segment) (DAB) 54

DMC (Digital Media Controller) 100

DSP Program (front display information) 79

E

ECO 96

Ensemble Label (DAB) 54

Equalizer 90

Error indication (front display) 117

Extra Bass 47, 89

F

Firmware update 105, 106

FM antenna connection 23

FM radio 48

FM radio tuning 56

Frequency (FM radio) 56

Frequency step setting 48, 104

Front display information 79

H

HDCP 20, 113

HDMI signal compatibility 124

I

INFO key 8

Initial scan (DAB radio) 52

Input (front display information) 79

Input Trim 82

Internet radio 72

iPod content playback 61

iPod content playback (AirPlay) 64

L

Language 102

Lipsync 82, 94

M

MAC Address 99, 100

Manual station preset (FM radio) 57

Max Volume 94, 95

Memory Guard 97

Menu language selection 26

Multiple room playback 75

Multi-zone 75

Muting 41

N

NAS content playback 69

Network Connection 99

Network information 99

Network Name 100

Network Standby 100

O

Option menu 80

P

Party mode 77

PEQ 90

PHONES jack 8

Power Amp Assign 88

Preset station selection (DAB radio) 53

Preset station selection (FM radio) 58

Preset station selection (FM/AM radio) 50

Program Type (DAB) 54

R

Radio Data System tuning 51, 59

Registering favorite items (shortcut) 78

Remote control 11

Remote control sensor 8

Remote ID 104
Rename 100
Repeat 63, 68, 71

S

SCENE 42, 92
Setup menu 84
Shortcut 78
Shuffle 63, 68, 71
Signal information 82
Sleep timer 11
Sleep timer (Zone2) 76
Sound program 44
Speaker impedance 13, 15, 103
Standby indicator (front panel) 8
Standby Through 91
Station preset (DAB radio) 53
Station preset (FM radio) 57
Straight decode 46
Subwoofer Trim 82
Surround decoder 46

T

Test Tone 90
Tone Control 81

U

USB jack 8
USB storage device content playback 66

V

Video/audio input jack combination 21
Virtual CINEMA FRONT 14, 45, 89
Volume scale 94

W

Wireless (Wi-Fi) 32, 99
Wireless Direct 39, 99
WPS 32, 34

Y

YPAO
(Yamaha Parametric room Acoustic Optimizer) 27

YPAO MIC jack 8

Z

Zone2 speaker connection 17, 75



YAMAHA CORPORATION

© 2015 Yamaha Corporation YH024B0/EN