

**Introduction**  
 Thank you for your purchase of the Yamaha PORTABLE PA SYSTEM STAGEPAS 150M. The STAGEPAS 150M is a versatile, compact PA system consisting of a speaker and a mixer. In order to get the most out of your new STAGEPAS 150M and its sophisticated functions, we suggest you read through this manual thoroughly. Also keep it in a safe place for future reference.

- Features**
- **Two-way, 8-inch (20 cm) speaker system**  
 The built-in speaker delivers high-quality powerful sound from an exceptionally compact cabinet. The scratch-resistant speaker is rugged enough for outdoor use.
  - **Powered mixer**  
 The powered mixer is a convenient, high-performance all-in-one unit that includes EQ and reverb. With two monaural inputs and three stereo inputs, the STAGEPAS 150M can be connected to a wide range of instruments and devices.
  - **Convenient storage**  
 The STAGEPAS 150M can be used in even the most cramped quarters, inside or outside, since the mixer is built into the speaker cabinet.

**Package Contents**  
 Speaker (300S), mixer, power cord, speaker cable, Owner's Manual (this booklet)

**NOTE:** The mixer is installed in the speaker when the STAGEPAS 150M leaves the factory.

# Before turning on the mixer

## Remove the mixer

- 1 **Be sure that the mixer's power switch is turned off.**
- 2 **Use a screwdriver or coin to turn each screw on the mixer from LOCK to OPEN until it clicks.**
- 3 **Securely hold the mixer's handles to remove it from the speaker.**

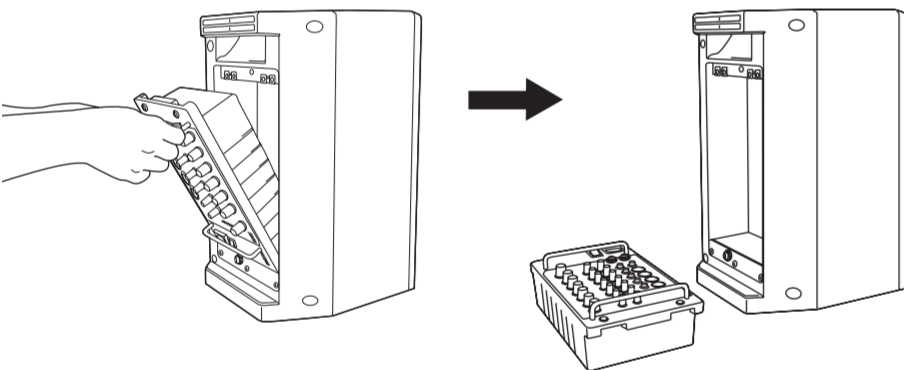
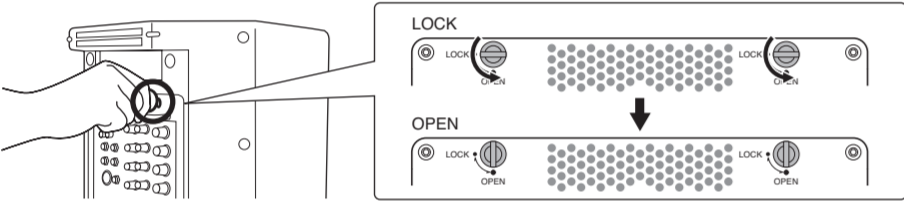

**Caution** Use only the mixer's handles when removing the mixer from the speaker and when carrying the mixer separate from the speaker.

**NOTE:** The mixer can also be used when installed in the speaker.

When you install the mixer into the speaker, make sure to match the indentations on the speaker cabinet to the corresponding parts on the mixer, and then turn each screw from OPEN to LOCK until it clicks.

## Turning the power on/off

- 1 **Be sure that the mixer's power switch is turned off.**
  - 2 **Connect the included power cord to the [AC IN] jack, and plug the power cord into a power outlet.**
- To avoid any loud, unexpected noise from the speakers, first turn on the power to those connected devices that are closest to the sound source.  
 Example: Sound source (CD player or instrument) → STAGEPAS 150M  
 When turning off the power to the system, reverse the order described above.
  - Before turning on the power, set the LEVEL controls and MASTER LEVEL control to their minimum setting (zero).

- 3 **Press the mixer's power switch to the ON position.**  
 The POWER indicator lights.  
**To turn the power off, press the power switch to the OFF position.**  
 The POWER indicator turns off.

# Troubleshooting

- Power does not turn on**
- Is the included power cord correctly connected to a power outlet?
- Power shuts down suddenly**
- Is the volume set at high for an extended period of time?  
 If the mixer is used at a volume beyond the permissible level, the protection circuit automatically turns the power off. Turn on the power again only after the mixer cools, since it cannot be turned on until the internal temperature goes down. Reduce the volume with the MASTER LEVEL control so that the LIMITER indicator flashes only briefly in response to the highest transient peaks.
  - Is the vent on the top panel of the mixer blocked?  
 Since inadequate ventilation can result in overheating the mixer, the protection circuit may come on automatically and the power may be turned off. Turn on the power again only after the mixer cools, since it cannot be turned on until the internal temperature goes down.

- No sound is heard**
- Are external instruments (including a microphone) or speakers correctly connected to the mixer?
  - Are the LEVEL controls of all relevant channels and/or the MASTER LEVEL control set to appropriate levels?
  - Is the SPEAKER jack connected to the included speaker (300S)?
  - Is the POWER indicator flashing? There may be a short in the speaker cable or the connection may be faulty. Check that the speaker cable is correctly connected to the mixer and reapply the power.
  - Is the CLICK switch (for headphones) set to OFF?
  - If sound is not still output, contact your Yamaha dealer.

- Sound is distorted or noise is produced**
- Are the LEVEL controls of all relevant channels and/or the MASTER LEVEL control set to appropriate levels?
  - Are the MIC/LINE switches of each channels set appropriately?
  - Are both XLR type and phone type jacks on channels 1–2 being used (connected) at the same time?  
 Please connect to only one of these jacks on each channel.
  - Is the input signal from the connected device set to an appropriate level?

- Sound is not loud enough**
- Are the LEVEL controls of all relevant channels and/or the MASTER LEVEL control set to appropriate levels?
  - Are the MIC/LINE switches of each channels set appropriately?
  - Are both XLR type and phone type jacks on channels 1–2 being used (connected) at the same time?  
 Please connect to only one of these jacks on each channel.
  - Is the input signal from the connected device set to an appropriate level?

- Reverb is not applied to the sound**
- Are the REVERB switches of each channels set to ON (■)?
  - Is the REVERB control set to an appropriate level?

- Getting a more powerful sound from the speakers**
- Is the SPEECH/MUSIC switch set to MUSIC (■)?
  - Are the Equalizer controls (HIGH/LOW) set to appropriate levels?

- Getting a clearer sound for announcements**
- Is the SPEECH/MUSIC switch set to SPEECH (■)?
  - Are the Equalizer controls (HIGH/LOW) set to appropriate levels?

- Outputting the signal to a main mixer**
- Connect a main mixer to the ST SUB OUT jack. The ST SUB OUT jack outputs the signal prior to routing through the MASTER LEVEL control. Adjust the level of output signal from the ST SUB OUT jack with the ST SUB OUT control. The ST SUB OUT control does not affect the MASTER LEVEL control. If only the L (left) ST SUB OUT jack is used, the mixer mixes the left and right signals and sends them to the jack.

## Block Diagram

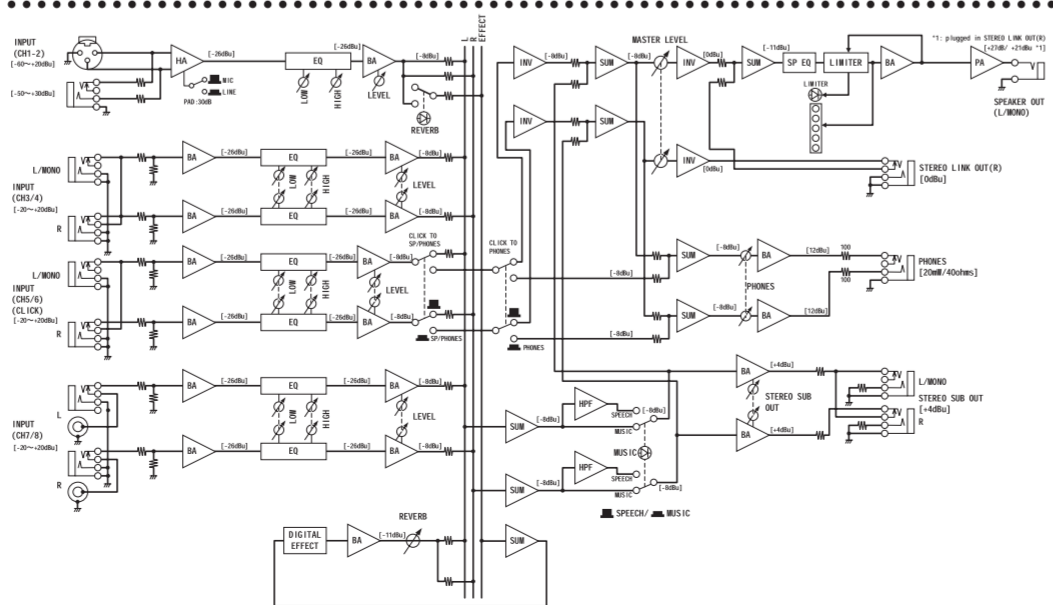

**CAUTION**  
 FROM THE RISK OF ELECTRIC SHOCK, DO NOT OPEN.  
 CAUTION: TO REDUCE THE RISK OF FIRE OR ELECTRIC SHOCK, DO NOT EXPOSE THIS APPARATUS TO RAIN OR MOISTURE.  
 THIS PRODUCT CONTAINS REPAIRABLE PARTS. REPAIR SERVICE SHOULD BE PERFORMED BY QUALIFIED SERVICE PERSONNEL.

The lightning flash with arrowhead symbol within an equilateral triangle is intended to alert the user to the presence of uninsulated "dangerous voltage" within the product's enclosure that may be of sufficient magnitude to constitute a risk of electric shock to persons.

The exclamation point within an equilateral triangle is intended to alert the user to the presence of important operating and maintenance (servicing) instructions in the literature accompanying the product.

# IMPORTANT SAFETY INSTRUCTIONS

- 1 Read these instructions.
- 2 Keep these instructions.
- 3 Heed all warnings.
- 4 Follow all instructions.
- 5 Do not use this apparatus near water.
- 6 Clean only with dry cloth.
- 7 Do not block any ventilation openings. Install in accordance with the manufacturer's instructions.
- 8 Do not install near any heat sources such as radiators, heat registers, stoves, or other apparatus (including amplifiers) that produce heat.
- 9 Do not defeat the safety purpose of the polarized or grounding-type plug. A polarized plug has two blades with one wider than the other. A grounding-type plug has two blades and a third grounding prong. The wide blade or the third prong are provided for your safety. If the provided plug does not fit into your outlet, consult an electrician for replacement of the obsolete outlet.
- 10 Protect the power cord from being walked on or pinched particularly at plugs, convenience receptacles, and the point where they exit from the apparatus.
- 11 Only use attachments/accessories specified by the manufacturer.
- 12 Use only with the cart, stand, tripod, bracket, or table specified by the manufacturer, or sold with the apparatus. When a cart is used, use caution when moving the cart/apparatus combination to avoid injury from tip-over.
- 13 Unplug this apparatus during lightning storms or when unused for long periods of time.
- 14 Refer all servicing to qualified service personnel. Servicing is required when the apparatus has been damaged in any way, such as power-supply cord or plug is damaged, liquid has been spilled or objects have fallen into the apparatus, the apparatus has been exposed to rain or moisture, does not operate normally, or has been dropped.

**WARNING**  
 TO REDUCE THE RISK OF FIRE OR ELECTRIC SHOCK, DO NOT EXPOSE THIS APPARATUS TO RAIN OR MOISTURE.

# PRECAUTIONS

**PLEASE READ CAREFULLY BEFORE PROCEEDING**  
 \* Please keep this manual in a safe place for future reference.

## WARNING

Always follow the basic precautions listed below to avoid the possibility of serious injury or even death from electrical shock, short-circuiting, damages, fire or other hazards. These precautions include, but are not limited to, the following:

- **Power supply/Power cord**
  - Only use the voltage specified as correct for the device. The required voltage is printed on the name plate of the device.
  - Use only the included power cord.
  - Do not place the power cord near heat sources such as heaters or radiators, and do not excessively bend or otherwise damage the cord, place heavy objects on it, or place it in a position where anyone could walk on, trip over, or roll anything over it.
- **Water warning**
  - Do not expose the device to rain, use it near water or in damp or wet conditions, or place containers on it containing liquids which might spill into any openings. If any liquid such as water seeps into the device, turn off the power immediately and unplug the power cord from the AC outlet. Then have the device inspected by qualified Yamaha service personnel.
  - Never insert or remove an electric plug with wet hands.
- **If you notice any abnormality**
  - If the power cord or plug becomes frayed or damaged, or if there is a sudden loss of sound during use of the device, or if any unusual smells or smoke should appear to be caused by it, immediately turn off the power switch, disconnect the electric plug from the outlet, and have the device inspected by qualified Yamaha service personnel.
  - If the device should be dropped or damaged, immediately turn off the power switch, disconnect the electric plug from the outlet, and have the device inspected by qualified Yamaha service personnel.
- **Do not open**
  - Do not open the device or attempt to disassemble the internal parts or modify them in any way. The device contains no user-serviceable parts. If it should appear to be malfunctioning, discontinue use immediately and have it inspected by qualified Yamaha service personnel.
- **Be sure to connect to an appropriate outlet with a protective grounding connection.** Improper grounding can result in electrical shock.

## CAUTION

Always follow the basic precautions listed below to avoid the possibility of physical injury to you or others, or damage to the device or other property. These precautions include, but are not limited to, the following:

- **Power supply/Power cord**
  - Remove the electric plug from the outlet when the device is not to be used for extended periods of time, or during electrical storms.
  - When removing the electric plug from the device or an outlet, always hold the plug itself and not the cord. Pulling by the cord can damage it.
- **Location**
  - Before moving the device, remove all connected cables.
  - When setting up the device, make sure that the AC outlet you are using is easily accessible. If some trouble or malfunction occurs, immediately turn off the power switch and disconnect the plug from the outlet. Even when the power switch is turned off, electricity is still flowing to the product at the minimum level. When you are not using the product for a long time, make sure to unplug the power cord from the wall AC outlet.
  - Do not use the device in a confined, poorly-ventilated location. Make sure that there is adequate space between the mixer and surrounding walls or other devices: at least 30 cm at the sides, 30 cm behind and 30 cm above. If the mixer is to be used installed into the speaker cabinet, make sure to allow adequate space between the speaker and the surrounding walls or other devices: at least 30 cm at the sides, 30 cm behind and 30 cm above. Inadequate ventilation can result in overheating, possibly causing damage to the device(s), or even fire.
  - Do not use the speaker's handles for suspended installation. Doing so can result in damage or injury.
  - Avoid setting all equalizer controls and faders to their maximum. Depending on the condition of the connected devices, doing so may cause feedback and may damage the speakers.
  - Do not expose the device to excessive dust or vibrations, or extreme cold or heat (such as in direct sunlight, near a heater, or in a car during the day) to prevent the possibility of panel discoloration or damage to the internal components.
  - Do not place the device in an unstable position where it might accidentally fall over.
  - Do not block the vents. This mixer has ventilation holes at the top to prevent the internal temperature from becoming too high. In particular, do not place the device on its side or upside down. Inadequate ventilation can result in overheating, possibly causing damage to the device(s), or even fire.
- **Handling caution**
  - When turning on the AC power in your audio system, always turn on the device LAST, to avoid speaker damage. When turning the power off, the device should be turned off FIRST for the same reason.
  - Do not insert your fingers or hands in any gaps or openings on the device (vents, ports, etc.).
  - Avoid inserting or dropping foreign objects (paper, plastic, metal, etc.) into any gaps or openings on the device (vents, ports, etc.) If this happens, turn off the power immediately and unplug the power cord from the AC outlet. Then have the device inspected by qualified Yamaha service personnel.
  - Do not use the device or headphones for a long period of time at a high or uncomfortable volume level, since this can cause permanent hearing loss. If you experience any hearing loss or ringing in the ears, consult a physician.
  - Do not operate the device if the sound is distorting. Prolonged use in this condition could cause overheating and result in fire.
  - Do not rest your weight on the device or place heavy objects on it, and avoid use excessive force on the buttons, switches or connectors.

## Interference From Cell Phones

Using a cell phone near the speaker system can induce noise. If this occurs, move the cell phone further away from the speaker system.

Air blowing out of the bass reflex ports is normal, and often occurs when the speaker is handling program material with heavy bass content.

Yamaha cannot be held responsible for damage caused by improper use or modifications to the device.

Always turn the power off when the device is not in use.

The performance of components with moving contacts, such as switches, volume controls, and connectors, deteriorates over time. Consult qualified Yamaha service personnel about replacing defective components.

- The illustrations as shown in this manual are for instructional purposes only, and may be different from the ones on your equipment.
- The company names and product names in this manual are the trademarks or registered trademarks of their respective companies.

**IMPORTANT**  
 Please record the serial number of this unit in the space below.  
 Model: \_\_\_\_\_  
 Serial No.: \_\_\_\_\_  
 The serial number is located on the bottom or rear of the unit. Retain this Owner's Manual in a safe place for future reference.

\* This applies only to products distributed by YAMAHA CORPORATION OF AMERICA. (See No.)

## Connections

- Before connecting the device to other devices, turn off the power for all devices. Before turning the power on or off for all devices, set all volume levels to minimum.
- For the SPEAKER jack, use only the included speaker (300S) and speaker cable. Use of other types of speakers and cables may result in damage to the device(s), or even fire.

## Dimensions

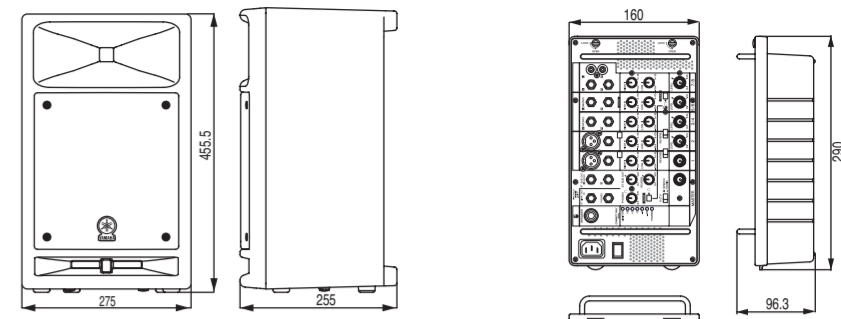

## Specifications

- General Specifications**
- Maximum Output Power  
 150 W (±10%) / 4Ω @ 10% THD at 1 kHz (SPEAKER)  
 ≥ 100 W / 4Ω @ 1% THD at 1 kHz (SPEAKER)
  - Maximum Output Level  
 112 dB (1 m)
  - Frequency Response (Nominal output level @ 1 kHz)  
 -3 dB, 0 dB, +1 dB @ 20 Hz-20 kHz (MUSIC/SPEECH+MUSIC) (ST SUB OUT)  
 -3 dB, 0 dB, +1 dB @ 20 Hz-20 kHz (MUSIC/SPEECH = SPEECH) (ST LINK OUT)  
 -3 dB, 0 dB, +1 dB @ 20 Hz-20 kHz, 1 W Output (MUSIC/SPEECH+MUSIC, without Speaker EQ) (SPEAKER)
  - Frequency Response (Nominal output level @ 1 kHz)  
 -3 dB, 0 dB, +1 dB @ 20 Hz-20 kHz (MUSIC/SPEECH+MUSIC) (ST SUB OUT)  
 -3 dB, 0 dB, +1 dB @ 20 Hz-20 kHz (MUSIC/SPEECH = SPEECH) (ST LINK OUT)  
 -3 dB, 0 dB, +1 dB @ 20 Hz-20 kHz, 1 W Output (MUSIC/SPEECH+MUSIC, without Speaker EQ) (SPEAKER)
  - Total Harmonic Distortion  
 ≤ 0.5% @ 20 Hz, 1 kHz, 20 kHz +14 dBu GAIN= nominal (ST SUB OUT, ST LINK OUT)
  - Hum & Noise (Equivalent Input Noise, Rs = 150Ω, MIC/LINE = MIC)  
 ≤ -112 dBu (CH1/2)
  - Crosstalk (1 kHz)  
 ≤ -70 dB between input channels
  - Power Consumption  
 20 W
  - Weight  
 9.6 kg (Speaker + Powered Mixer)
  - Stereo Input Channel Equalization  
 ±15 dB  
 HIGH 10 kHz shelving  
 LOW 100 Hz shelving
  - Speaker (300S)  
 Enclosure  
 2 way bass-reflex type, Polypropylene, Black
  - Crossover Frequency  
 4.0 kHz (LF: 12 dB/oct, HF: 12 dB/oct)
  - Frequency Range  
 55 Hz-20 kHz (-10 dB)
  - Speaker Unit  
 LF: 8" (20 cm) Cone  
 HF: 1" (25.4cm) Compression Driver

**FCC INFORMATION (U.S.A.)**

**1. IMPORTANT NOTICE: DO NOT MODIFY THIS UNIT!** This product, when installed as indicated in the instructions contained in this manual, meets FCC requirements. Modifications not expressly approved by Yamaha may void your authority, granted by the FCC, to use this product.

**2. IMPORTANT:** When connecting this product to accessories and/or other product use only high quality shielded cables. Cables supplied with this product MUST be used. Follow all installation instructions. Failure to follow instructions could void your FCC authorization to use this product in the USA.

**3. NOTE:** This product has been tested and found to comply with the requirements listed in FCC Regulations, Part 15 for Class "B" digital devices. Compliance with these requirements provides a reasonable level of assurance that your use of this product in a residential environment will not result in harmful interference with other electronic devices. This equipment generates radio frequencies and, if not installed and used according to the instructions found in the users manual, may cause interference harmful to the operation of other electronic devices. Compliance with FCC regulations does not guarantee that interference will not occur in all installations. If this product is found to be the source of interference, which can be determined by turning the unit "OFF" and "ON", please try to eliminate the problem by using one of the following measures. Relocate either this product or the device that is being affected by the interference. Utilize power outlets that are on different branch (circuit breaker or fuse) circuits or install AC line filters. In the case of radio or TV interference, relocate/reorient the antenna. If the antenna lead-in is 300 ohm ribbon lead, change the lead-in to co-axial type cable. If these corrective measures do not produce satisfactory results, please contact the local retailer authorized to distribute this type of product. If you can not locate the appropriate retailer, please contact Yamaha Corporation of America, Electronic Service Division, 6600 Orange Grove Ave., Buena Park, CA 90602.

The above statements apply ONLY to those products distributed by Yamaha Corporation of America or its subsidiaries.

**IMPORTANT NOTICE FOR THE UNITED KINGDOM**  
 Connecting the Plug and Cord

**WARNING:** THIS APPARATUS MUST BE EARTHED  
 IMPORTANT: The wires in the mains lead are coloured in accordance with the following code:  
 GREEN-AND-YELLOW : EARTH  
 BLUE : NEUTRAL  
 BROWN : LIVE

As the colours of the wires in the mains lead of this apparatus may not correspond with the coloured markings identifying the terminals in your plug proceed as follows:  
 The wire which is coloured GREEN-AND-YELLOW must be connected to the terminal in the plug which is marked by the letter E or by the safety earth symbol (⊕) or coloured GREEN-OR-GREEN-AND-YELLOW.  
 The wire which is coloured BLUE must be connected to the terminal which is marked with the letter N or coloured BLACK.  
 The wire which is coloured BROWN must be connected to the terminal which is marked with the letter L or coloured RED.

\* This applies only to products distributed by Yamaha/Yamaha Music Co., Ltd. (See No.)

NORTH AMERICA		POLAND		ASIA	
<b>CANADA</b> Yamaha Canada Music Ltd. 125 Milner Avenue, Scarborough, Ontario, M1S 3R1, Canada Tel: 416-298-1311		<b>Yamaha Music Central Europe GmbH</b> S.p. z o.o. <b>Central w Polsce</b> ul. 17 Syczyna 56, PL-02-146 Warszawa, Poland Tel: 022-888-07-87		<b>THE PEOPLE'S REPUBLIC OF CHINA</b> Yamaha Music & Electronics (China) Co., Ltd. 25/F, United Plaza, 1468 Nanjing Road (West), Jingan, Shanghai, China Tel: 021-6247-2211	
<b>U.S.A.</b> Yamaha Corporation of America 6600 Orange Grove Ave., Buena Park, Calif. 90620, U.S.A. Tel: 714-522-9011		<b>THE NETHERLANDS/                      BELGIUM/LUXEMBOURG</b> Yamaha Music Central Europe GmbH, Branch Benelux Clarendonhof 5-6, 4133 AB Vianen, The Netherlands Tel: 0347-358-040		<b>INDONESIA</b> PT. Yamaha Music Indonesia (Distributor) PT. Nusantara Gedung Yamaha Music Center, Jalan Jend. Gatot Subroto, Kav. 4, Jakarta 12930, Indonesia Tel: 61-525-2577	
<b>MEXICO</b> Yamaha de Mexico S.A. de C.V. Calle Javier Puga 600-1416, Col. Guadalupe del Moral C.P. 09300, Mexico, D.F., Mexico Tel: 55-5604-0600		<b>FRANCE</b> Yamaha Musique France BP 70-77312 Marnes-la-Vallée Cedex 2, France Tel: 64-64-6000		<b>KOREA</b> Yamaha Music Korea Ltd. 8F, 9F, Donggung Bldg. 158-9 Sansung-Dong, Kangnam-Gu, Seoul, Korea Tel: 02-04-02022	
<b>BRAZIL</b> Yamaha Musical do Brasil Ltda. Rua Joaquim Floriano, 913 - 4 andar, Itam Bibi, CEP 04534- 013 São Paulo, SP, BRAZIL Tel: 011-3704-1271		<b>ITALY</b> Yamaha Music Italia S.p.A. Combo Division Viale Italia 88, 20120 Linate (Milano), Italy Tel: 02-962-771		<b>Malaysia</b> Yamaha Music Malaysia, Sdn., Bhd. Lot 8, Jalan Perbandaran, 47301 Kelana Jaya, Petaling Jaya, Selangor, Malaysia Tel: 3-7630900	
<b>ARGENTINA</b> Yamaha Music Latin America, S.A. Sucursal de Argentina Viamonte 1145 Pasco 8 1033, Buenos Aires, Argentina Tel: 1-4371-7021		<b>SPAIN/PORTUGAL</b> Yamaha Música Bérica, S.A. Ctra. de la Corona km. 17, 200, 28230 Las Rozas (Madrid), Spain Tel: 91-639-8888		<b>SINGAPORE</b> Yamaha Music Asia Pte., Ltd. #03-11, A-2 Building 140 Paya Lebar Road, Singapore 409015 Tel: 747-4374	
<b>PANAMA AND OTHER LATIN AMERICAN COUNTRIES/                      CARIBBEAN COUNTRIES</b> Yamaha Music Latin America, S.A. Torre Banco General, Piso 7, Urbanización Marbella, Calle 47 y Aquilino de la Guardia, Ciudad de Panamá, Panamá Tel: +507-269-5311		<b>SWEDEN</b> Yamaha Scandinavia AB J. A. Wettergrens Gata 1, Box 30053 S-402 43 Göteborg, Sweden Tel: 031-81-34 100		<b>TAIWAN</b> Yamaha KHS Music Co., Ltd. 3F, #6, Sec.2, Nan-Jing E. Rd., Taipei, Taiwan 104, R.O.C. Tel: 02-2511-8688	
<b>GERMANY</b> Yamaha Music Central Europe GmbH Siemensstraße 22-34, 25462 Rellingen, Germany Tel: 04101-3030		<b>NETHERLANDS</b> Yamaha Music Central Europe GmbH Clarendonhof 5-6, 4133 AB Vianen, The Netherlands Tel: 0347-358-040		<b>THAILAND</b> Siam Music Yamaha Co., Ltd. 89/11 Siam Motors Building, 15-16 floor Rama 1 road, Wangmai, Pathumwan Bangkok 10330, Thailand Tel: 02-215-9520	
<b>GERMANY</b> Yamaha Music Central Europe GmbH Siemensstraße 22-34, 25462 Rellingen, Germany Tel: 04101-3030		<b>NORWAY</b> Norsk Hifi av Yamaha Scandinavia AB Greni Næringspark 1 N-1345 Skjellerå, Norway Tel: 67 16 77 70		<b>OTHER ASIAN COUNTRIES</b> Yamaha Corporation, Asia-Pacific Music Marketing Group Nakazawa-cho 10-1, Naka-ku, Hamamatsu, Japan 430-8650 Tel: +81-53-460-2313	
<b>GERMANY</b> Yamaha Music Central Europe GmbH Siemensstraße 22-34, 25462 Rellingen, Germany Tel: 04101-3030		<b>RUSSIA</b> Yamaha Music (Russia) Office 4015, entrance 2, 2115 Kuznetzkiy Most street, Moscow, 107996, Russia Tel: 495 628 6660		<b>OTHER EUROPEAN COUNTRIES</b> Yamaha Music Central Europe GmbH Siemensstraße 22-34, 25462 Rellingen, Germany Tel: +49-4101-3030	
<b>GERMANY</b> Yamaha Music Central Europe GmbH Siemensstraße 22-34, 25462 Rellingen, Germany Tel: 04101-3030		<b>AFRICA</b> Yamaha Corporation, Asia-Pacific Music Marketing Group Nakazawa-cho 10-1, Naka-ku, Hamamatsu, Japan 430-8650 Tel: +81-53-460-2313		<b>COUNTRIES AND TRUST TERRITORIES IN PACIFIC OCEAN</b> Yamaha Corporation, Asia-Pacific Music Marketing Group Nakazawa-cho 10-1, Naka-ku, Hamamatsu, Japan 430-8650 Tel: +81-53-460-2313	
<b>GERMANY</b> Yamaha Music Central Europe GmbH Siemensstraße 22-34, 25462 Rellingen, Germany Tel: 04101-3030		<b>MIDDLE EAST</b> Yamaha Corporation, Asia-Pacific Music Marketing Group Nakazawa-cho 10-1, Naka-ku, Hamamatsu, Japan 430-8650 Tel: +81-53-460-2313		<b>HEAD OFFICE</b> Yamaha Corporation, Asia-Pacific & Digital Musical Instrument Division Nakazawa-cho 10-1, Naka-ku, Hamamatsu, Japan 430-8650 Tel: +81-53-460-2441	

# Quick Guide

## Getting sound out of the system

Using the included speaker, set up the system and try it out.

**1 Connect the included speaker and your instruments to the mixer.**  
Connect the included speaker (300S) to the SPEAKER jack. Connect the sources (microphone, other instruments) to the input jacks. For details, see "Connection Example."

**Caution** Before connecting any devices, make sure to turn off the power for all devices (including microphones). Also, before turning the power on or off, set the volume levels on all devices to minimum.

**NOTE:** For best results when connecting an electric guitar or bass guitar to the mixer, use a direct box, preamp (guitar amp), or amp simulator.

**2 Set the mixer's LEVEL controls and MASTER LEVEL control to the minimum (zero).**

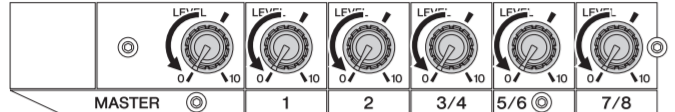

**3 Depending on the device used, set the MIC/LINE switch to MIC (M) or LINE (L) as appropriate.**

For low-level signals (such as that of microphones), set the switch to the MIC (M) position. For high-level signals (such as keyboard instruments and audio equipment), set the switch to the LINE (L) position.

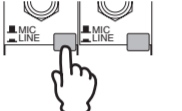

**4 Turning the power on**

First, turn on the power to any connected devices, then turn the STAGEPAS 150M power on. If you've connected powered speakers to the mixer, turn on the power of the mixer first, then the powered speakers.

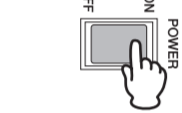

**Caution** To avoid any loud, unexpected noise from the speakers, first turn on the power to those connected devices that are closest to the sound source.

**Example:** Sound source (CD player or instrument) → STAGEPAS 150M → (Power amplifier)  
When turning off the power to the system, reverse the order described above.

**5 Set the MASTER LEVEL control to the optimum position (indicated by the arrow).**

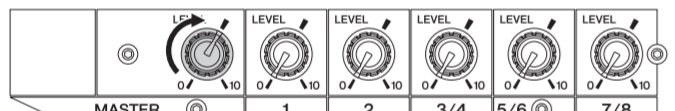

**6 While playing your instrument or singing into the microphone, adjust the LEVEL control of the corresponding channel.**

Adjust the LEVEL Control of the corresponding channel so that the "0" LED lights up momentarily.



**7 Use the MASTER LEVEL control to adjust the overall volume.**

**Caution** If the LIMITER indicator flashes continuously, the internal power amplifier section is being excessively overloaded and may malfunction.



## Applying reverb or echo to the sound

Reverb recreates the warm ambience of an actual performance space, such as a concert hall or a night club.

**1 For each channel you want to apply reverb, set the corresponding REVERB switch to ON (O).**

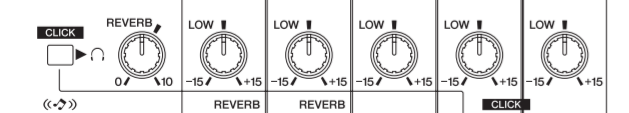

**2 Use the REVERB control to adjust the overall reverb.**

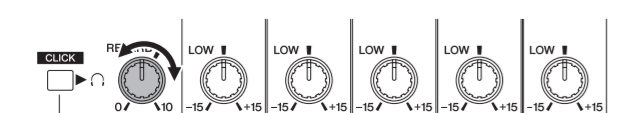

## Connection Example 1

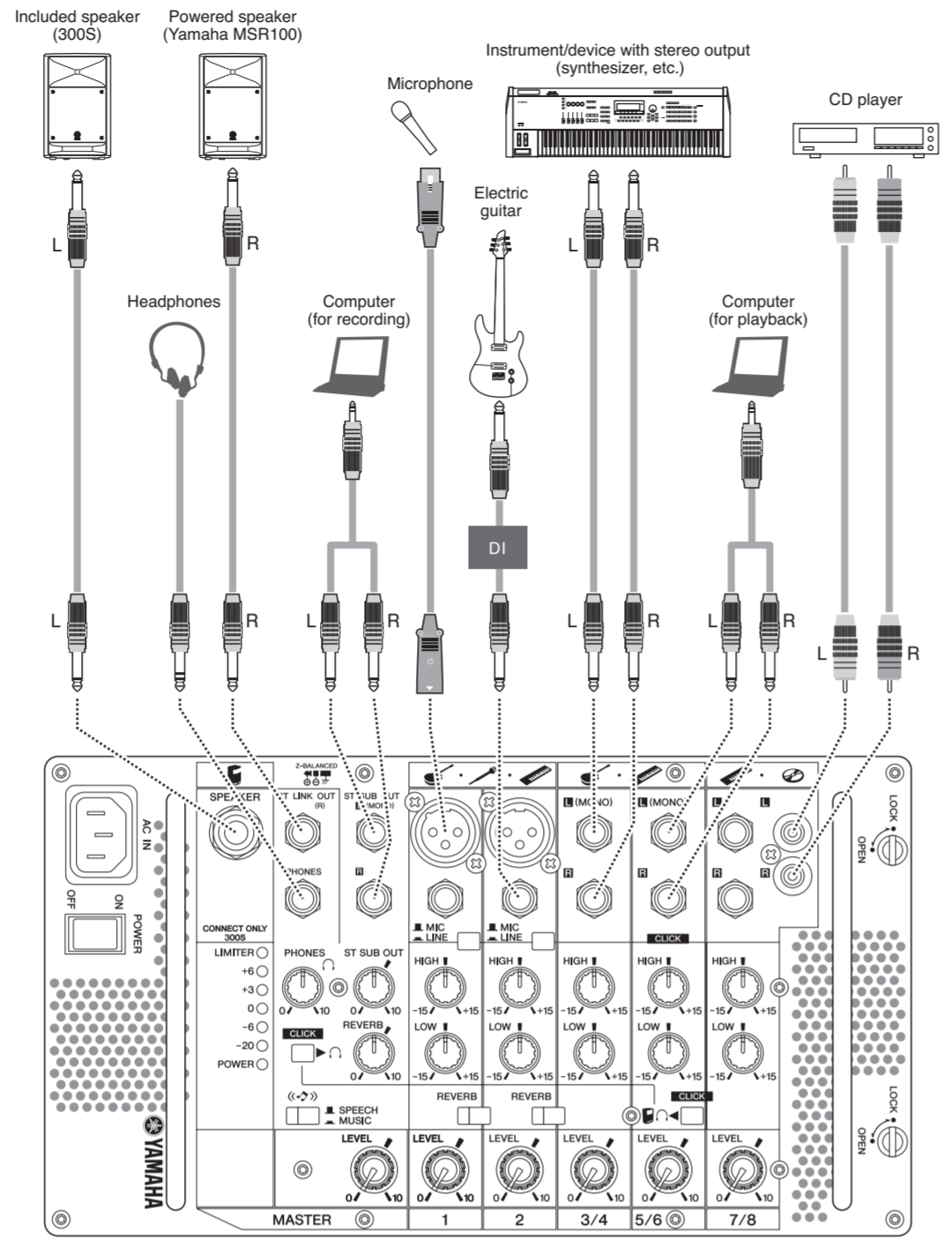

## Connection Example 2

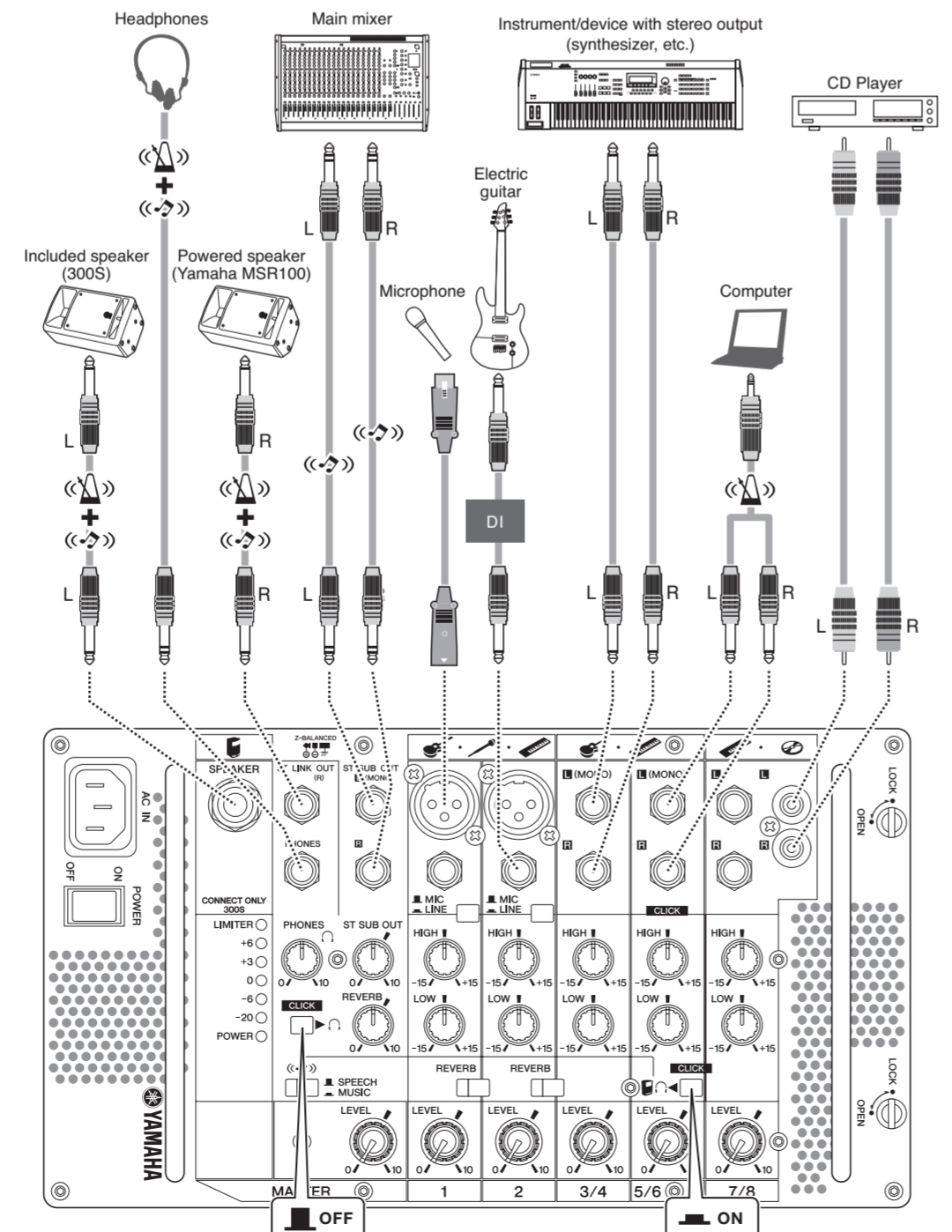

## Controls and Functions

**1 AC IN jack**  
Connect the included power cord here.

**Caution** Be sure to use the included power cord. Use of other cords may result in malfunction, heat generation, or fire.

**2 POWER switch**  
For turning the power to the mixer on and off.

**20 LEVEL meter**  
The LEVEL meter shows the level of the output signal from the SPEAKER jack.

**Caution** If the LIMITER flashes continuously, the internal power amplifier section is being excessively overloaded and may malfunction. Reduce the output level with the MASTER LEVEL control so that the indicator flashes only briefly on the highest transient peaks.

**21 POWER indicator**  
This lights when the POWER switch is ON. When the indicator flashes, the protection circuit is operating. Check that the speaker cable is correctly connected to the mixer and reapply the power.

**3 SPEAKER jack (for included speaker 300S only)**

This outputs the mixed monoaural L+R signal channels from 1 to 7/8 and the level is adjusted with the MASTER LEVEL control. Connect only the included speaker (300S).

**4 ST LINK OUT R jack**

This outputs signals from R (even) channels only. When inserting a plug to this jack, only signals from the L (odd) channels are supplied to the SPEAKER jack. The output level is adjusted with the MASTER LEVEL control. Used with the SPEAKER jack, this lets you output the signals in stereo from the speakers.

**5 PHONES jack**

This outputs the mixed signal channels from 1 to 7/8, and the level is adjusted with the PHONES control. Connect a set of headphones here.

**6 ST SUB OUT L (MONO) / R jacks**

These output the mixed signal channels from 1 to 7/8, and the level is adjusted with the ST SUB OUT control. You can use these jacks, for example, to connect a main mixer. These impedance balanced jacks allow a longer cable to be connected with the use of a balanced cable.

**7 ST SUB OUT control**

Determines the signal level output from the ST SUB OUT jacks.

**NOTE:** The MASTER LEVEL control does not affect the signal via the ST SUB OUT control.

**8 PHONES control**

Determines the signal level output from the PHONES jack.

**NOTE:** The MASTER LEVEL control does not affect the signal via the PHONES control.

**9 Channel input jacks (CH 1, 2)**

For connecting a guitar, microphone, keyboard or other instrument/device. Set the MIC/LINE switch to MIC or LINE for channels 1, 2, depending on the level of the input signal.

XLR-type connectors are wired as follows (IEC60268 standard): pin 1: ground, pin 2: hot (+), and pin 3: cold (-).

**NOTE:** On any given channel, you may use either XLR or phone jack, but not both. Please connect to only one of these jacks on each channel.

**10 Stereo channel input jacks (CH 3/4, 5/6, 7/8)**

Input the left and right channels of a stereo signal into the respective odd and even channels of the mixer. These inputs are intended mainly for use with instruments and equipment having stereo outputs, such as a synthesizer or CD player.

**NOTE:** The channel 7/8 input provides two sets of jacks—both phone jacks and RCA-pin jacks. Either one of these jacks may be used, but not both at the same time. Please connect to only one of these jacks on each channel.

**11 MIC/LINE switch**

Set this switch to MIC or LINE for channels 1, 2, depending on the level of the input signal. For low-level signals (such as that of microphones), set the switch to the MIC (M) position. For high-level signals (such as keyboard instruments and audio equipment), set the switch to the LINE (L) position.

**Caution** To avoid damage to speakers, be sure to turn off amplifiers (or powered speakers) before setting this switch to MIC or LINE. We also recommend that you turn the MASTER LEVEL control to the minimum setting before operating the switch, to avoid excessively loud noises that could cause hearing loss or device damage.

**12 Equalizer**

**HIGH:** Determines the level of the high frequency band for each channel. Rotating the knob clockwise boosts the high frequencies and produces a clearer, crisper sound. If you start getting feedback (a high-pitched squealing sound) or you want to make the sound softer and less harsh, turn the knob counterclockwise slightly.

**LOW:** Determines the level of the low frequency band for each channel. Rotating the knob clockwise boosts the low frequencies and produces a deeper, warmer sound. If you start getting feedback or you want to make the sound less boomy, turn the knob counterclockwise slightly.

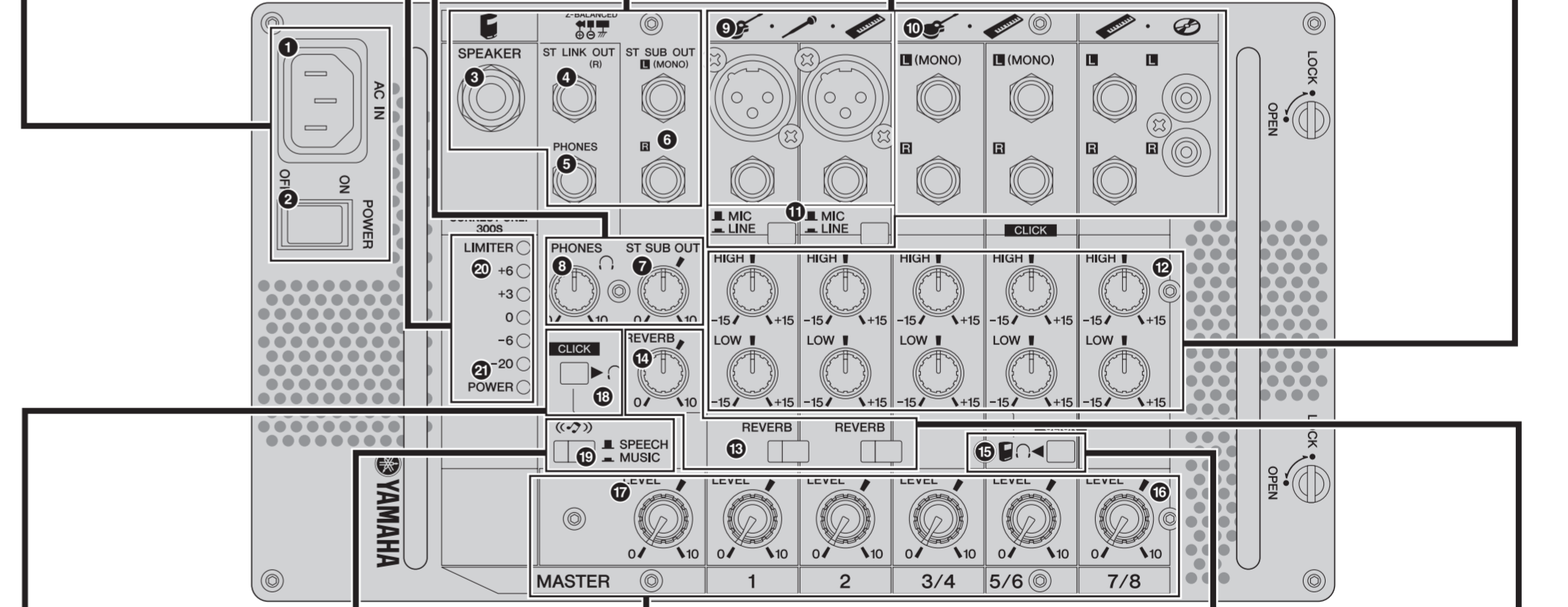

**18 CLICK switch (for headphones)**

Set this switch to ON to assign the click/metronome sounds to only the PHONES jack when the CLICK switch at the channel 5/6 is ON.

**19 SPEECH/MUSIC switch**

Set this switch to SPEECH (S) to optimize the mixer settings and sound quality for speech purposes and announcements. Set this to MUSIC (M) to optimize the mixer for musical performance. The switch lights up in yellow when it is set to MUSIC (M).

**16 LEVEL control**

Use these controls to adjust the volume balance among the various channels.

**Caution** To reduce noise, set any LEVEL controls on unused channels to the minimum.

**17 MASTER LEVEL Control**

Determines the volume of the signal output from the SPEAKER jack. This allows you to adjust the overall volume without changing the relative volume balance among the various channels (made with the LEVEL controls) or the tone settings (made with the Equalizer).

**15 CLICK switch (for headphones/speaker)**

Set this switch to ON to assign the click (metronome) sounds that sent to the channel 5/6 to the PHONES jack, SPEAKER jack, and ST LINK OUT R jack, but not to the ST SUB OUT jacks. Setting this switch to ON lets the player monitor the click (metronome) sounds of a sequencer or a synthesizer.

**13 REVERB switch**

Set this switch to ON to recreate the rich ambience of various performance environments, such as a concert hall or a night club. The switch lights up in green when REVERB is ON (O).

**14 REVERB control**

Determines the overall level of the reverb or echo that is applied to the output signal. For best results, this level should not be set very high, to avoid possible feedback and to prevent the sound from becoming "muddy" with too much reverb.