



# **AFC Image Editor User Guide**

# Table of Contents

1.	Abstract .....	4
1.1.	Scope of this Guide.....	4
1.2.	GUI Window Overview .....	5
1.3.	System Block Diagram.....	6
2.	System Requirements and Installation.....	7
2.1.	System Requirements.....	7
2.2.	Installing AFC Image Editor .....	8
2.3.	Uninstalling AFC Image Editor .....	8
3.	System Setup .....	9
3.1.	Setup and Connection.....	9
3.2.	Starting/Closing AFC Image Editor.....	9
3.3.	Overall Control.....	12
3.4.	Speaker Settings.....	13
3.5.	Zone and Rendering Area Conversion Setting .....	17
3.6.	I/O Patch.....	19
3.7.	Other Input/Output settings .....	22
4.	Control and Set Object .....	24
4.1.	Pairing .....	24
4.2.	Setting up Objects.....	24
4.3.	Other Settings.....	26
5.	Scene .....	28
5.1.	Registering a Scene.....	29
5.2.	Updating a Scene .....	29
5.3.	Recalling a Scene .....	30
5.4.	Deleting a Scene.....	30
6.	3D Rev. ....	30
6.1.	Selecting and Adjusting the Reverb Pattern.....	31

6.2.	Configuring the Basic Characteristics of 3D Reverb .....	32
6.3.	Space .....	33
6.4.	Equalizer.....	33
6.5.	Preset .....	34
7.	Binaural .....	34
7.1.	Listener Position (Listener) .....	34
7.2.	Source Select .....	35
7.3.	External Object Input .....	35
7.4.	Surround Input Level (Surround In).....	36
7.5.	3D Reverb Level (Reverb) .....	36
8.	Saving and Loading a Project File .....	37
	Appendix .....	38
	Zone and Rendering Area Conversion.....	38
	Rendering Area Conversion .....	38

**Revision History**

Nov., 2021: Released the first edition

# 1. Abstract

## 1.1. Scope of this Guide

This guide explains how to use AFC Image Editor. AFC Image Editor is software for setting up and controlling an AFC Image system. With its sophisticated graphical interface, AFC Image Editor allows laying out and zoning speakers that output rendered signals, routing audio in the system, etc.

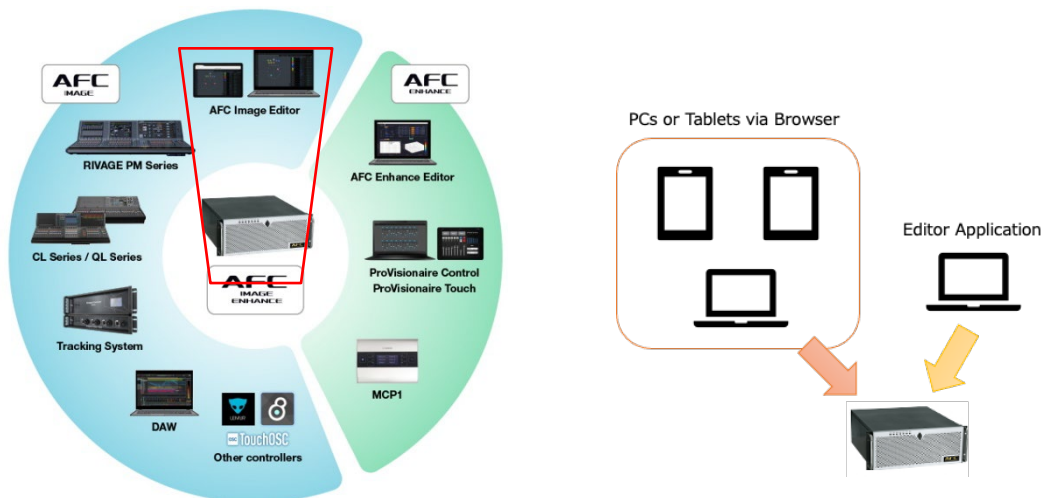

### Comparison between AFC Image Editor and browsers

	Available to use	Setting & Control	File Transportation
AFC Image Editor	1	Yes	Yes
Browsers	8	Yes	No

### NOTE

- A browser can also fully control AFC Image except for file transportation (loading /saving project files, importing/exporting speaker lists), and up to 8 browsers can access the system at the same time. To reduce network traffic, after a project file is loaded by the Editor Application, it is recommended using a browser for controlling and disconnecting the Editor Application.
- To control AFC Image by a browser, the address is "[Kontron processor's IP address]:8080".

E.g.: 192.168.1.11:8080

## 1.2. GUI Window Overview

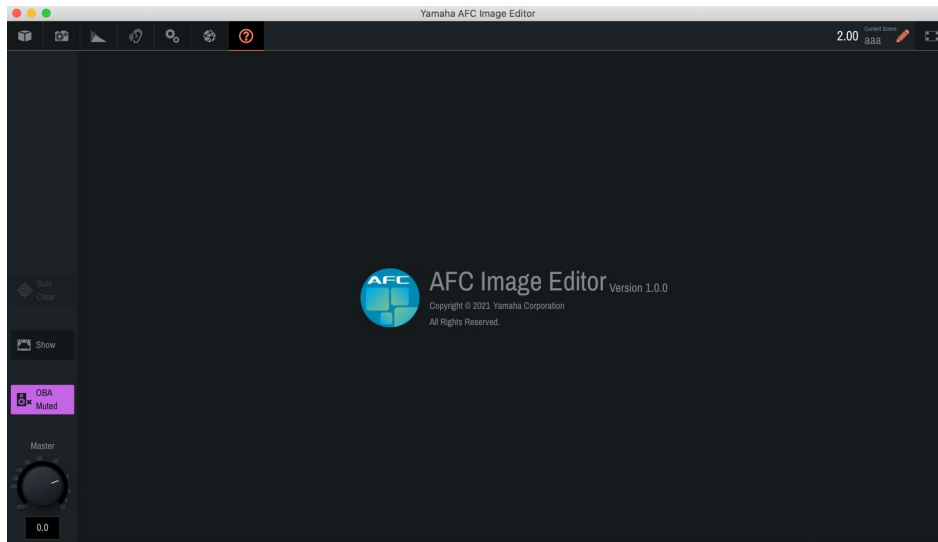

### Object Set & Control Tab

- Set & control objects



### Scene Management Tab



### 3D Reverb Setting Tab



### Binaural Processing Setting Tab



### System Setup Tab

- Speakers, Zones, and Rendering Area Conversion settings
- System synchronization, IP settings, project file load/save, and URL information for connecting by a web browser.



### I/O Setup Tab

- AUX input, Rec/AUX/Binaural Out, settings
- Input & Output Patch settings

### 1.3. System Block Diagram

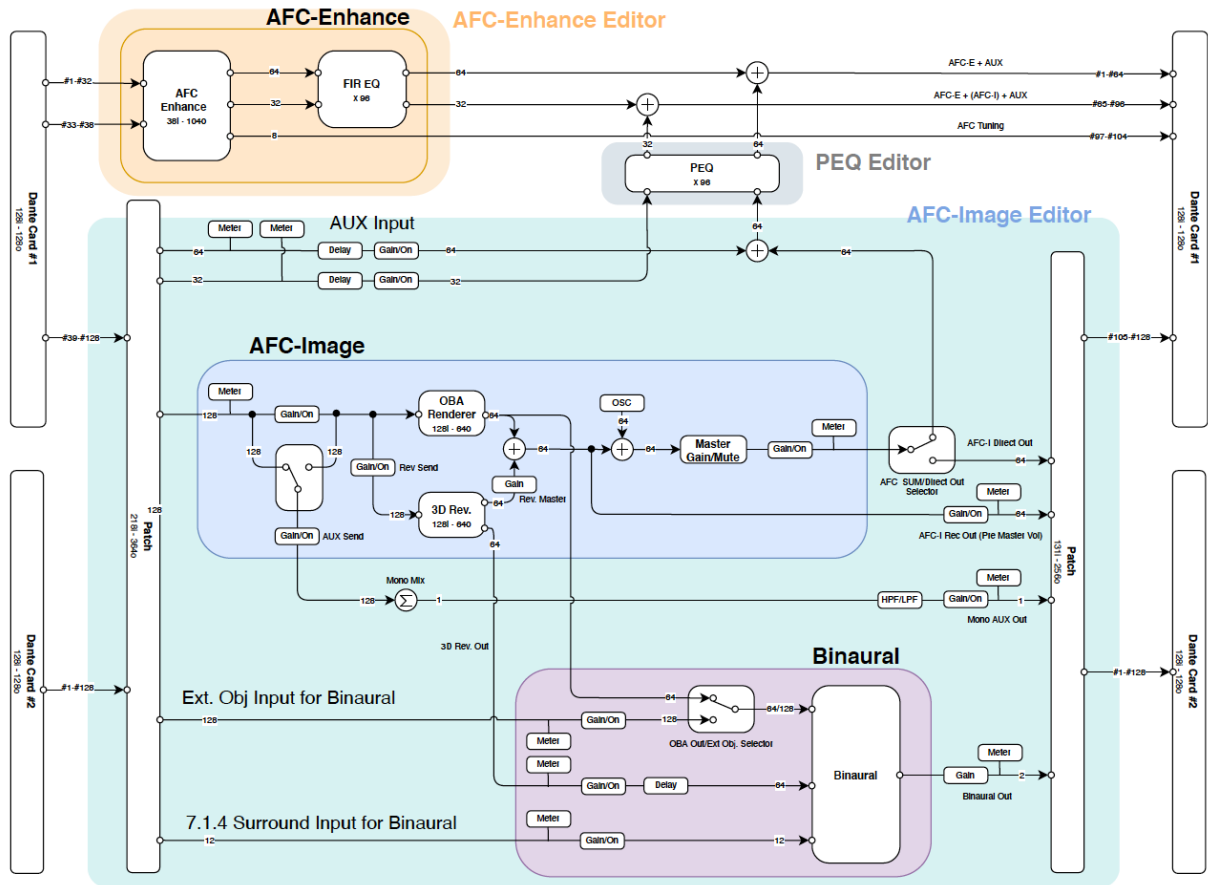

#### 1.3.1. AFC Image

- **OBA Renderer**  
Generates suitable speaker outputs to create images at the defined position for each object.
- **3D Rev.**  
Creates high-quality reverb which is close to actual venue reverberation behavior.
- **Outputs**  
Integrates OBA outputs and 3D Rev. outputs, and sends them to Master Out and Rec Out. Both outputs have their own output gain.  
Master Outputs can be routed to be mixed with AFC Enhance output, OR to out directly independent from the AFC Enhance output.

### 1.3.2. Binaural

- Binaural  
Generates L/R Binaural signals and gives a feeling of 3D sound to the AFC Image by a headphone. OBA outputs or external Obj. inputs are selectable for processing.
- 7.1.4 Surround Input  
For Binaural processing, 7.1.4 surround sources are available to be mixed.

### 1.3.3. AUX Input

- External sources can flow onto AFC Image Editor and output to the Enhance Output line for integrating with another system that shares the speakers.

### 1.3.4. AUX output

- All object inputs can be mono mixed for monitoring etc.

## 2. System Requirements and Installation

### 2.1. System Requirements

OS	Windows 10	macOS 10.15 (Catalina), 11 (Big Sur)
CPU	Intel 64-bit processors running at 2 GHz or faster (for Windows and macOS), AMD CPUs (for Windows).	
Memory	4GB or more	
HDD	500MB or more	
Display	1280 x 1024 pixels, 32,000 colors or higher	
Other	Pointing device such as a mouse Ethernet connection (1000BASE-T/100BASE-TX)	

## 2.2. Installing AFC Image Editor

### 2.2.1. Windows

Extract the downloaded file to a location on the hard drive.

To change the location where the files are stored, move them together with the Yamaha AFC Image Editor-win32-x64 folder.

### 2.2.2. MacOS

Open the downloaded disk image and copy the Yamaha AFC Image Editor.app file to your Application folder.

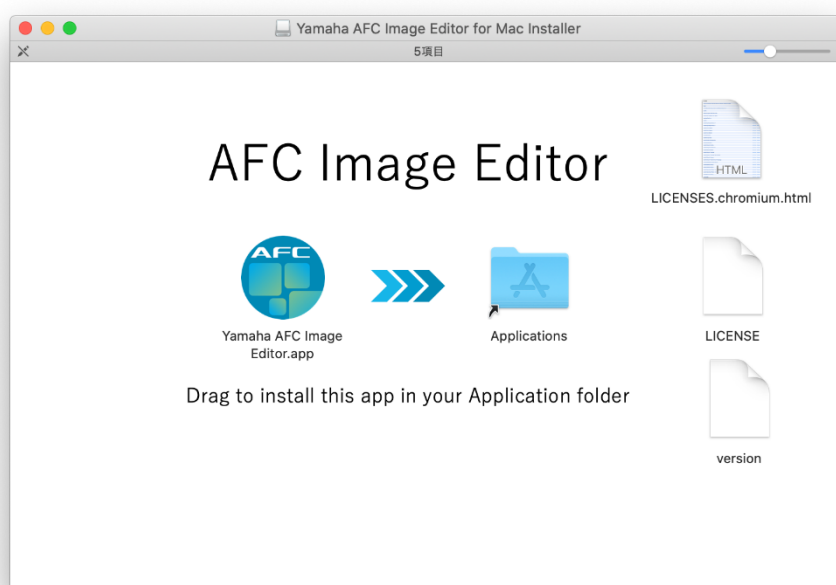

## 2.3. Uninstalling AFC Image Editor

### 2.3.1. Windows

Delete all the downloaded files and the Yamaha AFC Image Editor-win32-x64 folder.

### 2.3.2. MacOS

Delete the Yamaha AFC Image Editor.app file.



## 3. System Setup



### 3.1. Setup and Connection

1. Set an IP address of the PC to which AFC Image Editor is installed to the one different from Kontron 2-A0FK-0001 (Kontron Processor) but in the same subnet.  
E.g.: 192.168.1.20
2. Connect the Network ports for both the PC and Kontron Processor to the same network.



### 3.2. Starting/Closing AFC Image Editor

#### 3.2.1. Starting AFC Image Editor in Online Mode (Connecting with Kontron Processor)

1. Launch the AFC Image Editor application.
2. Input the following information.
  - Local IP:  
Select the IP address of your Editor PC that is in the same subnet as the Kontron processor from the drop-down list.
  - Remote IP:  
Enter the IP address of the Kontron Processor.
  - Sync Direction:
    -  Editor PC data will be overwritten by the current data of the Kontron processor.
    -  Kontron Processor data will be overwritten by the current data of Editor

PC.

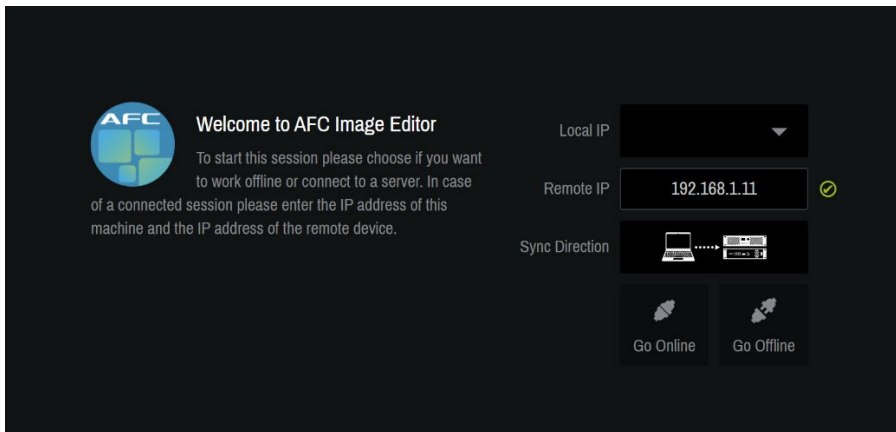

3. **Make sure that the Kontron Processor is running normally, then click “Go Online” to connect with the Kontron Processor.**

If the following message appears and the connection does not complete, check if the system can be accessed via a browser.

- If a browser can access it, check the network connection status of the Editor PC.
- If a browser cannot access it, restart the Editor PC after reconfirming the IP and network settings and connection status.

✘ Error: 127.0.0.2 does not seem to be running an AFC editor.

#### NOTE

- It will take about three minutes after the Kontron Processor is turned on for AFC Image Editor to be able to connect to the Kontron Processor.

### 3.2.2. Starting AFC Image Editor in Offline Mode (Not connecting with Kontron Processor)

1. **Launch the AFC Image Editor application.**

**2. Click the “Go Offline” button to open the Editor.**

The Local and Remote IP settings are not necessary when using the Editor offline.

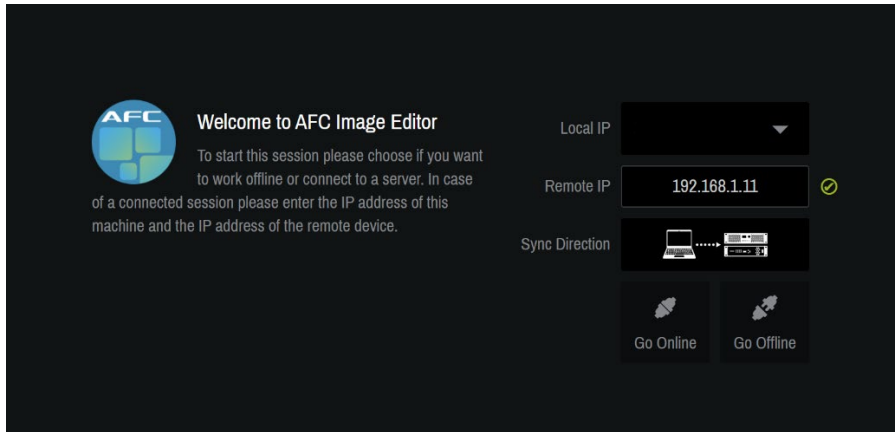

**3.2.3. Closing AFC Image Editor**

Use CTRL + w for Windows, or Command + w or Command + q for Mac OS to close AFC Image Editor.

### 3.3. Overall Control

#### 3.3.1. Show Mode

Turning on the Show button will enter the Show mode, which is generally used during a show. In the Show mode, the solo function becomes unavailable to prevent an unintended accident.

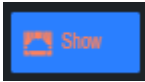

#### 3.3.2. Master Gain/Mute

The Master gain and mute can be set using the Master control and OBA Mute button at the left side of the window. The shape of the Master volume control changes between a fader and knob depending on the window size.

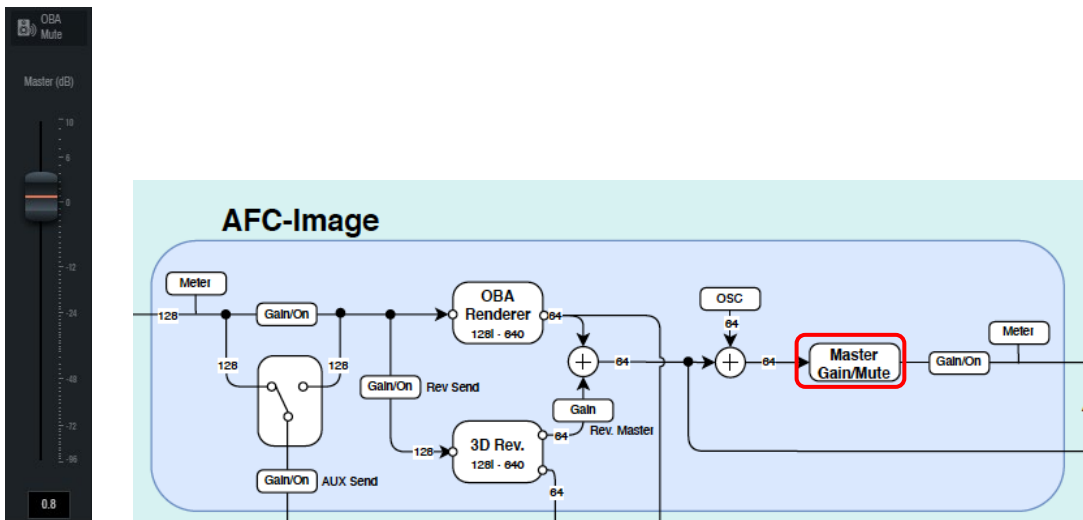

### 3.4. Speaker Settings

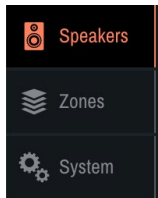
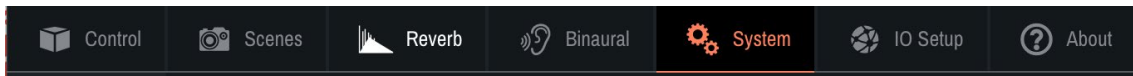

#### X-Y View

#	Name	X	Y	Z	Gain (dB)	Level (dB)	On	Mute
1	UpStageLL	-10.00	20.00	7.00	0.00		On	
2	UpStage CL	-5.00	20.00	7.00	0.00		On	
3	UpStage C	0.00	20.00	7.00	0.00		On	
4	UpStage CR	5.00	20.00	7.00	0.00		On	
5	UpStage R	10.00	20.00	7.00	0.00		On	
6	MidStage L	-12.00	12.00	7.00	0.00		On	
7	MidStage C	0.00	12.00	18.00	0.00		On	
8	MidStage R	12.00	12.00	7.00	0.00		On	
9	DownStage L	-10.00	4.00	7.00	0.00		On	
10	DownStage C	0.00	4.00	18.00	0.00		On	
11	DownStage R	10.00	4.00	7.00	0.00		On	
12	Proce L	-12.00	0.00	7.00	0.00		On	
13	Proce CL	-6.00	0.00	14.00	0.00		On	
14	Proce C	0.00	0.00	14.00	0.00		On	
15	Proce CR	6.00	0.00	14.00	0.00		On	
16	Proce R	12.00	0.00	7.00	0.00		On	
17	Wall L1	-17.00	-5.00	3.00	0.00		On	
18	Wall L2	-17.00	-10.00	3.00	0.00		On	
19	Wall L3	-17.00	-15.00	3.00	0.00		On	
20	Wall L4	-17.00	-20.00	3.00	0.00		On	

## X-Z View

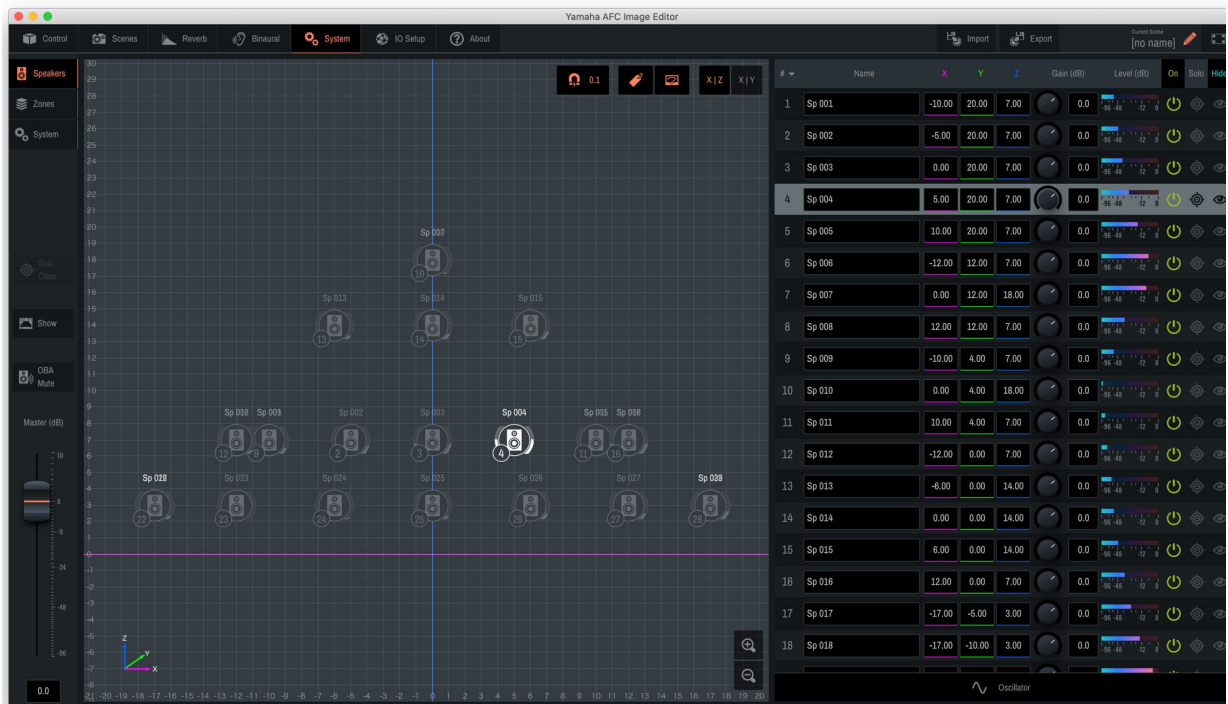



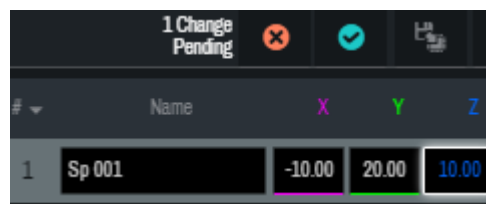

To lay out speakers, drag & drop the speaker icons on the map, or enter the position in the list at the right. When the speakers are positioned the way you want, click the check icon shown at the top of the window to confirm the changes. To cancel the changes, click the “x” icon.



### NOTE

- If there are no speakers shown on the map, click the Hide icons of the speakers to turn it off.

## [Map]

-  : Specifies how the speakers move, whether to move them smoothly or snap them to the specified interval. And the interval can be changed between Off (free layout), 0.1, 0.2, 0.5, and 1.0 m.
-  : Shows/hides the speaker's name on each icon.
-  : Shows/hides the level meter on each icon.
-  : Switches the map view mode between XY (plan) and XZ (section).

## [Speaker List Table]

- Coordinate (X, Y, and Z): Shows/sets the position of each speaker [m].
- Gain (dB): Adjusts speaker level. It does not influence Rec out, AFC Enhance output, or AUX input line.
- Solo: (In the Online mode) “Solo” can be used to check the sound of each speaker individually. “Solo” settings for multiple speakers can be cleared by clicking the “Solo Clear” icon on the left side of the map.
- Hide: Shows/hides a speaker on the map.

## NOTE

- The Solo function becomes unavailable when in the Show mode.

### 3.4.1. Importing & Exporting Speaker Data

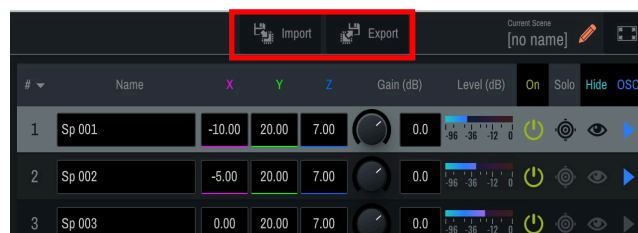

Import: Imports speaker position data in an .nys file to the Editor.

Export: Exports and stores the current speaker position information to the PC as an .nys file.

## NOTE

- An .nys file can be exported by the NEXO NS-1 software.

### 3.4.2. Oscillator

It can be used to check the line from the speakers and set on/off of each speaker output.





## 3.5. Zone and Rendering Area Conversion Setting

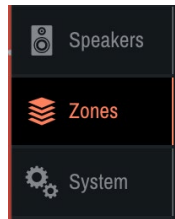

“Zone” is to group speakers to control objects. An object must belong to one Zone and up to 32 zones can be defined.

If the objects are controlled by DAW or Console panner which is defined in a square or cubic panning area, that panning area will be converted according to the area specified by the zone so the objects will be panned within the area. “Rendering Area Conversion” can define this conversion.

### NOTE

- See Appendix on page 38 for details on “Zone” and “Rendering Area Conversion”.

### 3.5.1. Zone

On the right table, select the speakers to be grouped in a zone. By clicking the “gear” icon at the right end, the Selected Zone Details window opens. You can also select speakers to be grouped in the zone.

### Zone List Window

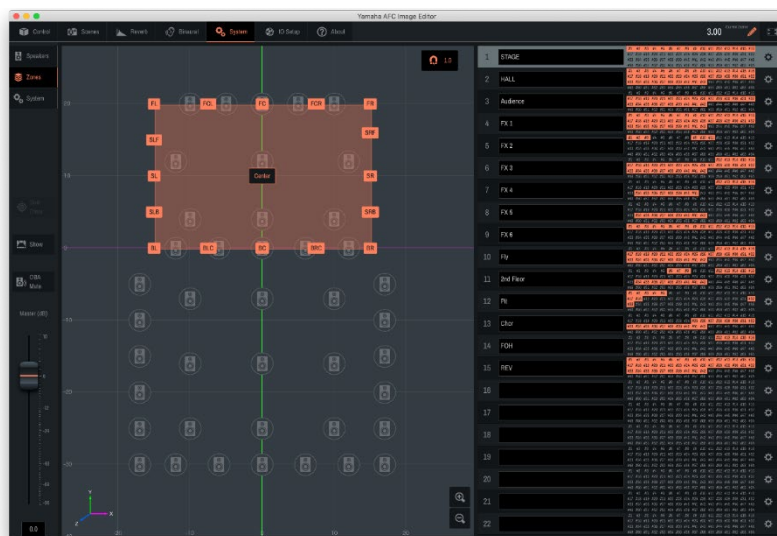

## Selected Zone Details Window

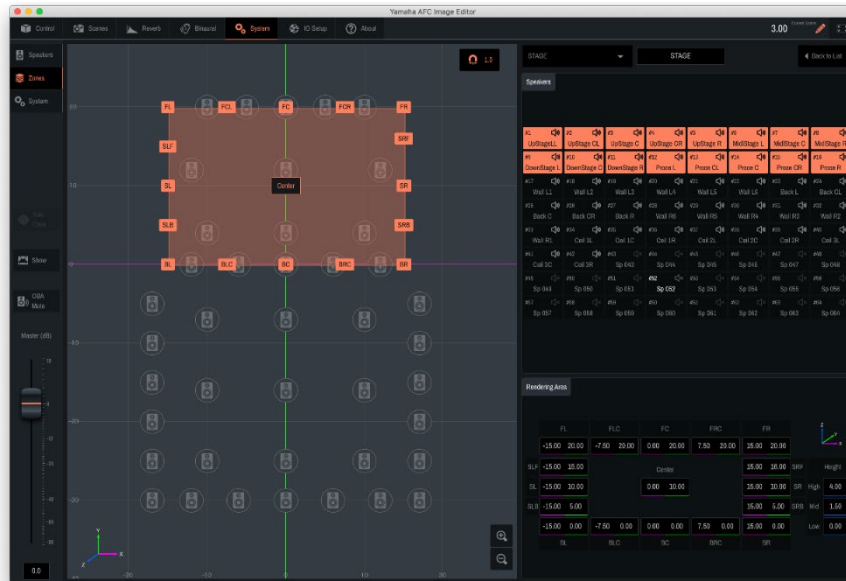

### 3.5.2. Rendering Area Conversion

In the Selected Zone Details window, you can define the rendering area conversion. This conversion is defined by an orange hexadecagon with its center. Drag & drop each vertex on the left map or enter each vertex position on the right bottom area to specify the rendering area. Not only for XY plan shape but also 3 layers including height can be defined for conversion of cubic panning area.

## 3.6. I/O Patch

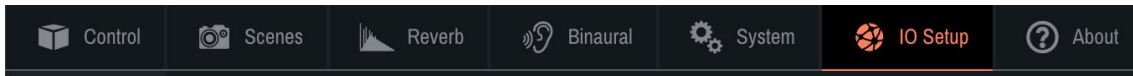

### 3.6.1. Input Patch

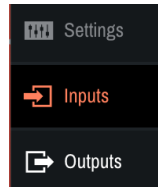

#### NOTE

- Ch1 – ch38 of Dante Input Card #1. are reserved for AFC Enhance inputs.

In this window, Dante inputs can be patched to the following processing inputs.

- Object inputs (1 - 128)
- AUX Inputs (1 - 96)
- 7.4.1 Surround Inputs for Binaural Processing (1 - 12)

These CHs follow the ITU and Nuendo definition.

CH1	Left	CH7	Side Left
CH2	Right	CH8	Side Right
CH3	Center	CH9	Top Front Left
CH4	LFE	CH10	Top Front Right
CH5	Left Surround	CH11	Top Back Left
CH6	Right Surround	CH12	Top Back Right

- Ext. Object Inputs for Binaural Processing (1 - 128)

For easy patching or de-patching, by dragging the area and double-clicking either icon, input channels in the selected area can be automatically patched at the diagonal cross points or de-patched.

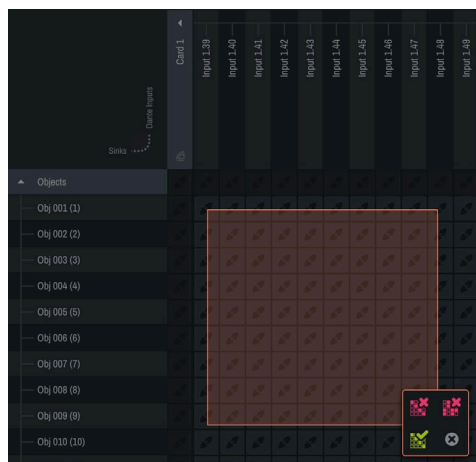
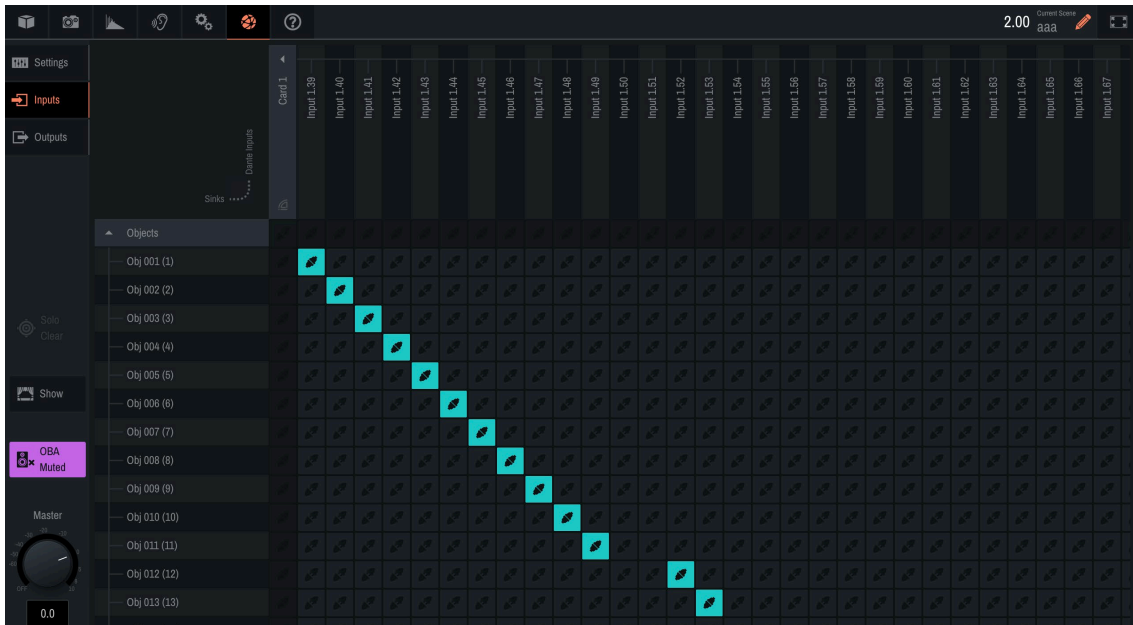

### 3.6.2. Output Patch

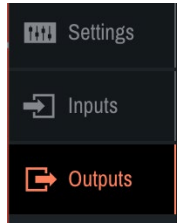

#### NOTE

- Ch1 – ch104 of Dante Output Card #1. are reserved for AFC main outputs as follows.
  - ch1 – ch96: AFC Main out CH1 – CH96
  - ch97 – ch104: AFC Enhance tuning outputs.

In this area, Dante outputs can be patched to the following processing outputs.

- AFC Image Direct outputs (1 - 64)
- AFC Image Rec outputs (1 - 64)
- AUX output (1)
- Binaural outputs (2)

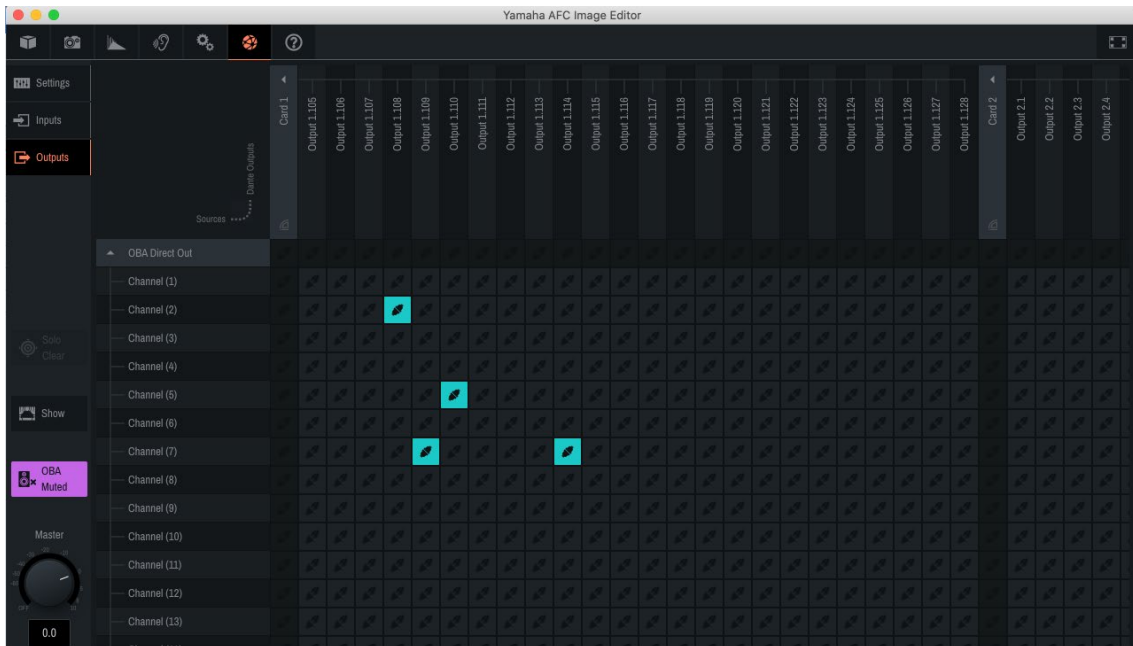

## 3.7. Other Input/Output settings

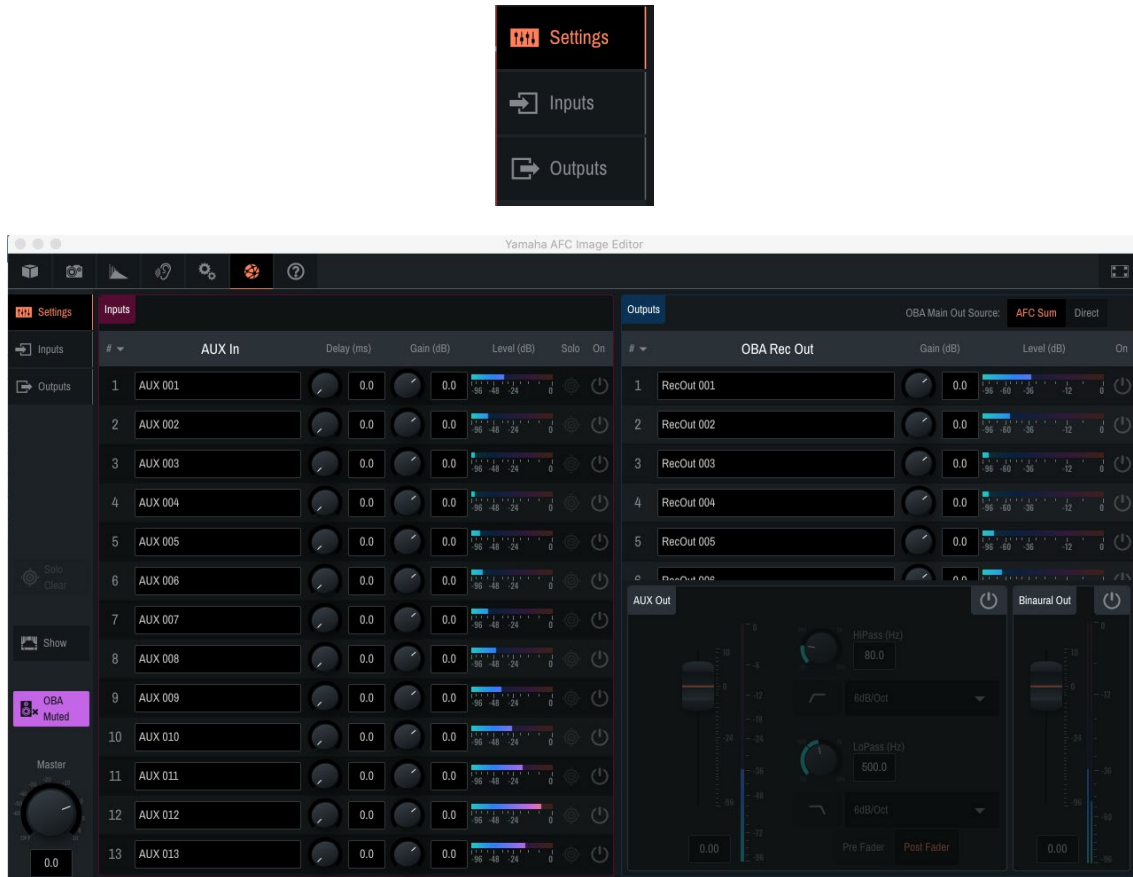

### 3.7.1. AUX Inputs

Delay, Gain, and On/Off for each AUX Input CH settings can be made. The “Solo” function is also available for tuning and checking the system.

### 3.7.2. AFC Image OBA Master Output routing (OBA Main Out Source)

- **AFC Sum:**  
OBA Master Output will be mixed with the AFC Enhance Outputs and AUX Inputs, and fed to the AFC Main Out.
- **Direct:**  
OBA Master Output will be directly fed to the output patch without mixing the AFC Enhance Output and an AUX Input. This is used for an outboard EQ or AFC Image outputs only.

### **3.7.3. AFC Image OBA Rec Out**

Rec Out is also an AFC Image OBA Output but independent from the Master and each speaker Gain.

### **3.7.4. AUX Out**

Mixed mono signals of the selected objects can be picked up by using AUX out for monitoring etc. "Pre" or "Post" can be set to the object gain for mixing, but all channels are linked. HPF and LPF are also available for AUX out.

### **3.7.5. Binaural Out**

Controls the Binaural Output gain.

## 4. Control and Set Object

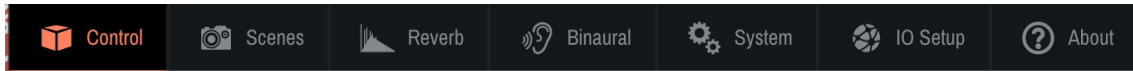

### 4.1. Pairing



By clicking the Pairing icon, parameters of Gain, Solo, Hide, Position, Size, AUX Send, Rev Send, Recall Safe, and Setting can be linked between two objects with adjacent ID numbers.

Click the “Join” button to link the two adjacent objects. To unlink the objects, click the “Release Pairing” button.

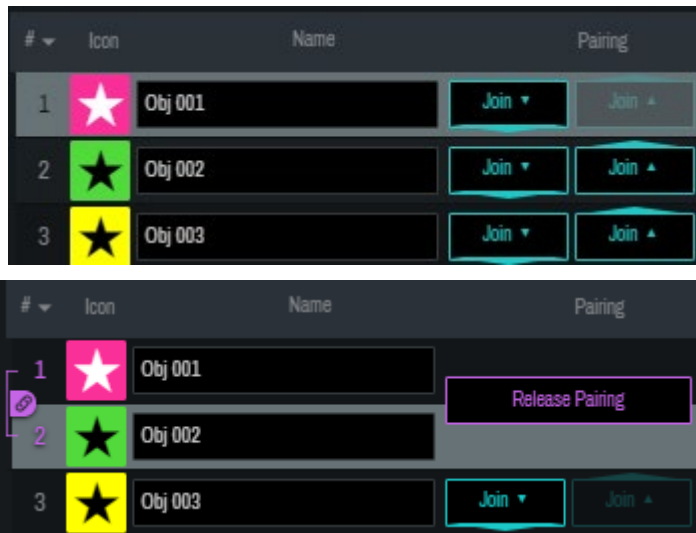

### 4.2. Setting up Objects

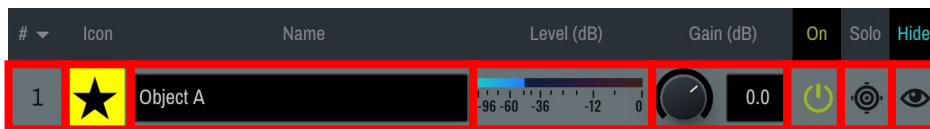

- # (ID Number):  
ID number of each object. Objects can be sorted by ID number.



- **Icon:**  
An icon and color can be set to each object.

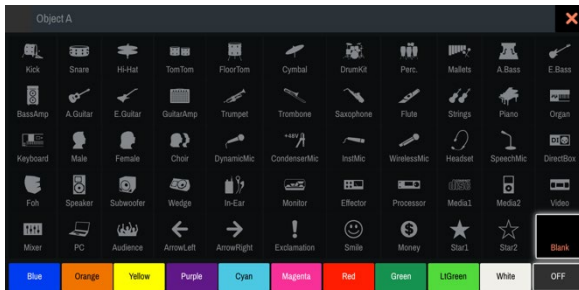

- **Name:**  
Shows/Edits the name of each object. Objects can be sorted by name.
- **Level (dB):**  
Shows the input level of each object
- **Gain:**  
Shows and adjusts the gain level of each object (target of scene recall).
- **On:**  
Sets on/off to each object. All the objects can be turned on/off by clicking [On] at the top (target of scene recall).
- **Solo:**  
Sets on/off of Solo in place to each object. The solo in place setting of all the objects can be turned on/off by clicking "Solo" at the top. Please note that the solo function is not available when in the Show mode.

### 4.3. Other Settings

The following parameters can be shown by clicking the parameter name and select the one that you want to edit. Or clicking the arrows also switches the parameters.



- **Position:**  
Shows/edits the position of each object by a coordinate of X, Y, and Z (target of scene recall). X, Y, and Z can be somewhere between -500(m) and 500(m).



- **Type:**  
Shows/edits the type of each object. The type can be selected from Manual, Static, and External.
  - **Manual:** The object can be positioned and moved by inputting the coordinate or dragging the object on the Map View.
  - **Static:** The object can be positioned by inputting the coordinate (X, Y, and Z). (The position of a static object cannot be changed. Currently, it can be moved by external control.)
  - **External:** The object can be positioned and moved by inputting the coordinate or by external control.
- **Size:**  
Shows the object's size by its width and height (target of scene recall). It can be set between 0 to 100.

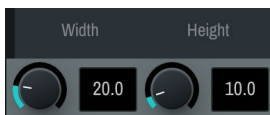

- **AUX Send:**  
Sets on/off and the level of the AUX send (target of scene recall). AUX of all objects can be switched between Pre Gain and Post Gain simultaneously on the "Settings" of the IO Setup tab.



- **Rev Send:**

Sets on/off of the 3D reverb send and the level (Post Gain) (Target of scene recall).

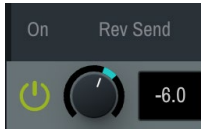

- **Recall Safe:**

Specifies if the following parameters of each object are not recalled by recalling a Scene.

- **On:** On/off setting of the Recall Safe function. If this option is off, recalling a Scene will update all the settings of the object even if other Recall Safe parameters are set on.
- **XYZ:** Coordinate information of the object
- **Size:** Width and Height of the object
- **AUX:** On/off status and the level of the AUX send
- **Rev:** On/off status and the level of the 3D Reverb send

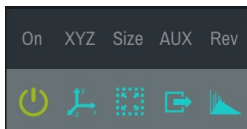

- **Setting:**

Other settings of the object, etc.

- **X-Y Mode:** Sets on/off of the X-Y Mode. When on, the Z coordinate of the object is disabled, and rendering is executed regardless of each speaker's Z coordinate.
- **Zone:** Sets a zone where the object belongs (See “Zone and Rendering Area Conversion Setting” on page 17). It defines speakers that output each object as well as the pan moving range defined in a square or cube shape by DAW or consoles.

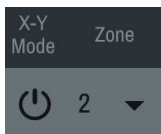

## 5. Scene

The current object settings can be stored as a scene, and it can later be recalled. The following information is stored:

- On/off and gain settings of the objects
- Objects' positions, sizes, icons, colors, names, and types
- On/off and level settings of AUX sends
- On/off and level settings of Rev. Sends

### NOTE

- Parameters of each object can be set individually to be excluded from a scene recall by setting the Recall Safe on the Obj. Control screen.
- Scenes do not include the following information: presets of zone settings, 3D Rev., and pairing.
- Please note that the current pairing settings will remain even if a new scene is recalled.

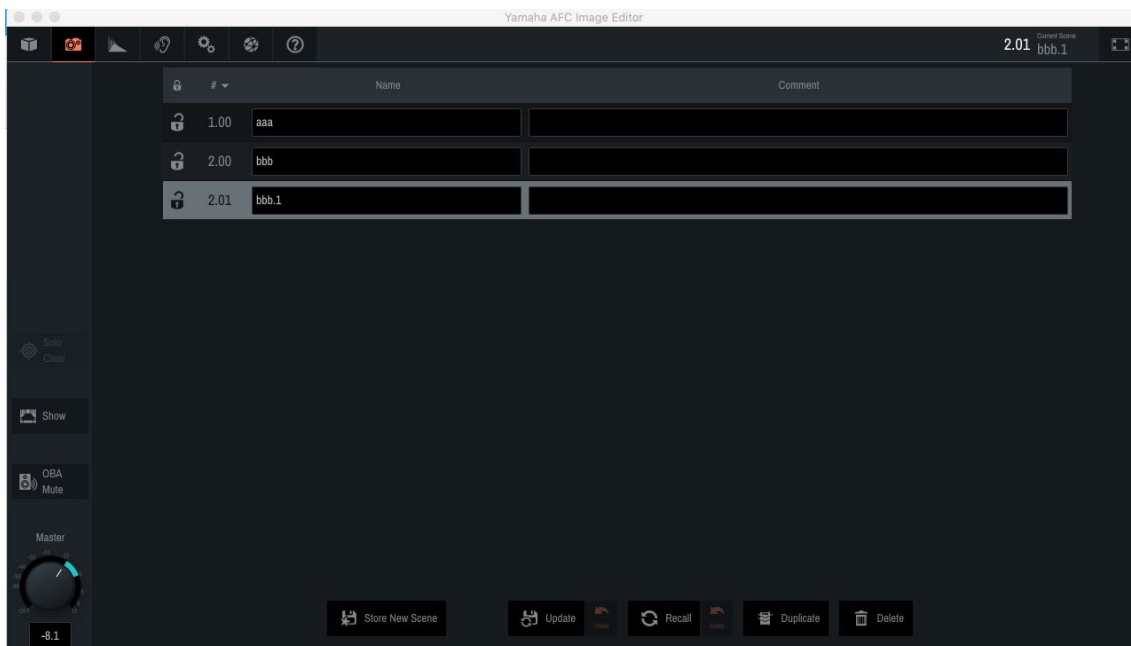

The currently recalled scene number appears in the top right corner.

The following image indicates that Scene 1.00 is recalled, and no changes are made.

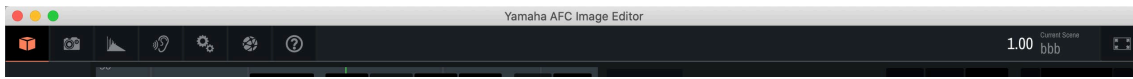

The following image indicates that Scene 2.01 is recalled and some settings such as positions are edited.

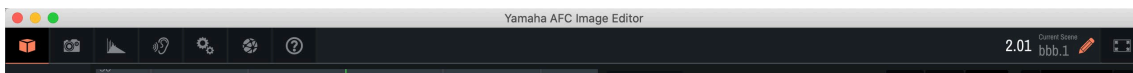

## 5.1. Registering a Scene

By clicking the "Store New Scene" button, the following popup window opens. Input a Scene name, comment, scene number (1 to 1000), and version number (sub number of the scene number) (0 to 99). After all the information is input, click "Store New Scene". This will create a Scene with the current settings. By combining a scene number and version number, a Scene from 1.00 to 1000.99 can be stored. A scene name and comment can be edited on the Scene list.

### NOTE

- Half-width alphanumeric characters can be input to the Scene name and comment.



## 5.2. Updating a Scene

To overwrite the changes onto the currently recalled scene, press the "Update" button. This will change the button to orange for confirmation, then press the "Update" again to overwrite the changes. To cancel the overwrite, press the orange "Undo" button that becomes active after the overwrite is completed.

### 5.3. Recalling a Scene

To recall a Scene, select a Scene to be recalled on the Scene list and press the "Recall" button. To cancel the Scene recall, press the orange "Undo" button that becomes active after the scene is recalled.

### 5.4. Deleting a Scene

To delete a Scene, select a Scene to be deleted on the Scene list and press the "Delete" button. This will change the button to orange for confirmation, then press the button again to delete the Scene. If the currently recalled Scene is deleted, "no name" appears at the top right corner instead of the Scene number. However, the current settings are kept as they are.

## 6. 3D Rev.

3D Reverb provides high-quality 3-dimensional reflection and reverberation optimal to each object position.

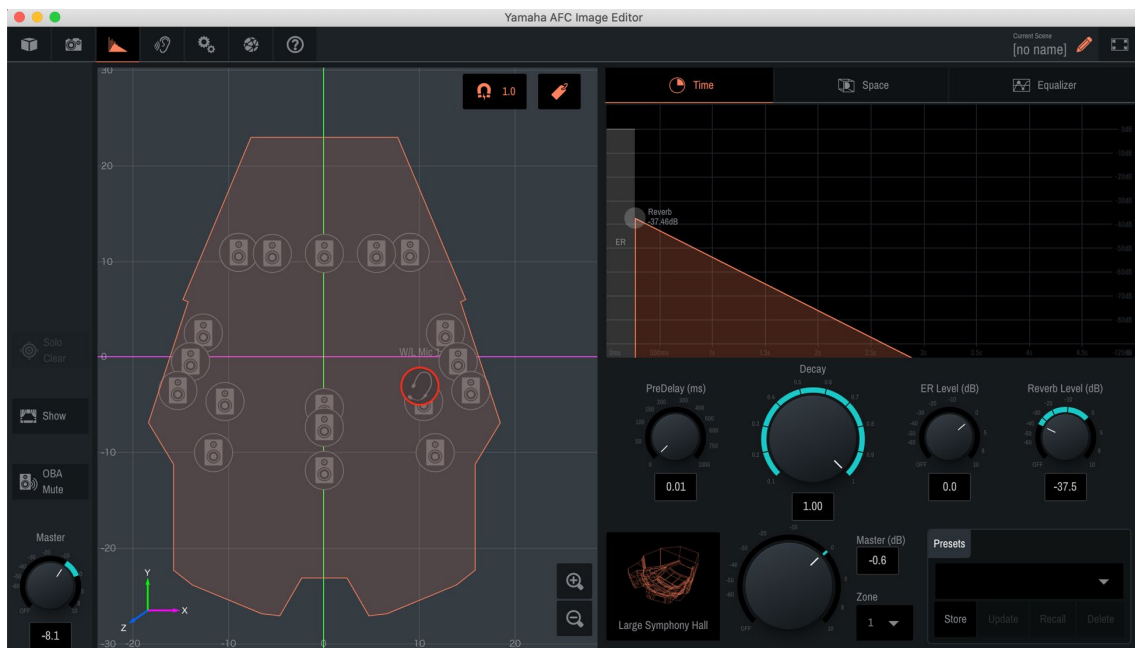

Use the Master Gain knob at the bottom to adjust the overall output level of the 3D Reverb. And with the Zone option next to the Master Gain knob, select a zone to determine which zone the 3D Reverb is output.

## 6.1. Selecting and Adjusting the Reverb Pattern

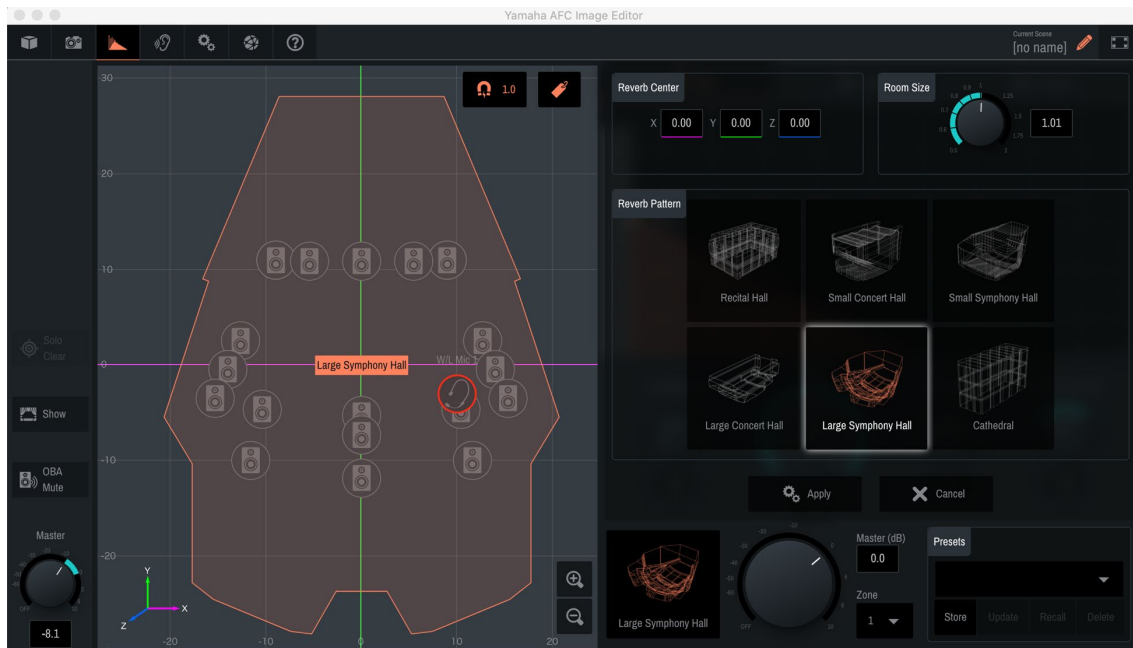

Click the room icon next to the Master Gain knob to open the window for selecting and adjusting the reverb pattern. It provides 6 reverb patterns from Recital Hall to Cathedral. The room size and center can be adjusted according to the speaker positions as follows.

- The room size: Use the Room Size knob at the top right.
- The Center of the room: Input the coordinate in the Reverb Center field or drag the orange label of the reverb pattern on the map.

When the reverb pattern, size, and position are the way you want, press the Apply button to apply the settings.

## 6.2. Configuring the Basic Characteristics of 3D Reverb

In the Time window, the basic settings for the 3D Reverb can be made.

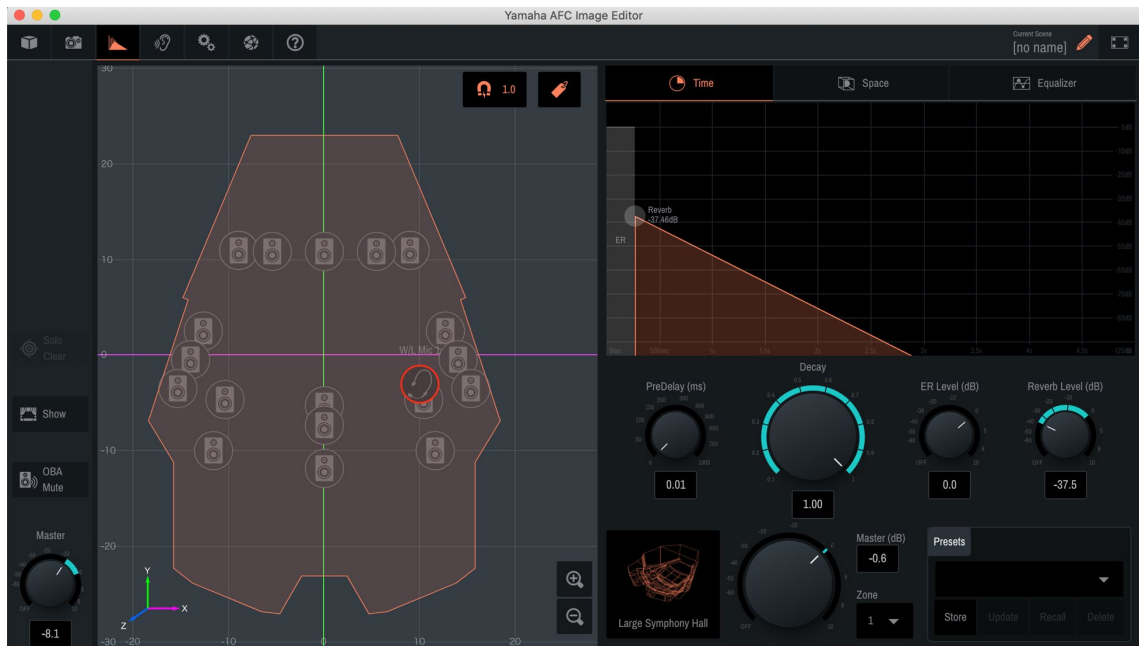

- **Pre Delay:**  
Adjusts the delay time when the 3D Reverb including early reflection becomes effective.
- **Decay:**  
Adjusts the time decay characteristics of the Reverb component.
- **ER Level:**  
Adjusts the level of the early reflection component.
- **Reverb Level:**  
Adjusts the level of the reverb component.

### NOTE

- Pre Delay, ER Level, and Reverb Level can also be adjusted by dragging the graph.



## 6.3. Space

In the Space window, the spatial image of the 3D Reverb can be adjusted.

The head images help you to intuitively grasp the spatial variation of the parameters around the human head facing the Y-axis direction.

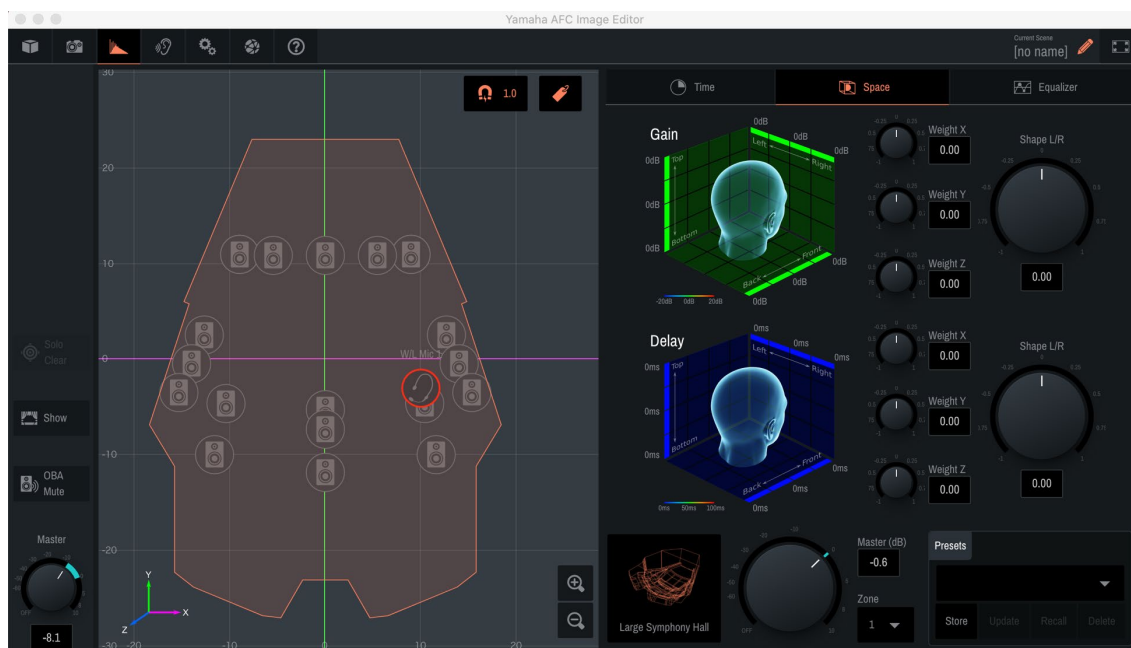

### 6.3.1. Gain

Gain bias can be applied in the X, Y, and Z-axis directions by adjusting the X, Y, and Z Weights. And Gain distribution in the X-axis direction can be shifted from the center to both sides using the Shape L/R knob.

### 6.3.2. Delay

Delay bias can be applied in the X, Y, and Z-axis directions by adjusting the X, Y, and Z Weights. And Delay distribution in the X-axis direction can be shifted from the center to both sides using the Shape L/R knob.

## 6.4. Equalizer

In the Equalizer window, the frequency response of the 3D Reverb can be adjusted by using the High Pass filter and 4 band PEQ.

## 6.5. Preset

Up to 64 3D Reverb settings can be stored as the presets. All the settings made in the Time, Space, and Equalizer windows as well as the Master Gain and Zone settings are stored.

## 7. Binaural

To quickly monitor the outputs of the AFC Image or use AFC Image-based stereophonic contents for streaming and other purposes, AFC Image provides the headphone output function that gives a sense of three-dimensionality and directionality. (The sense of three-dimensionality and directionality may vary among individuals.)

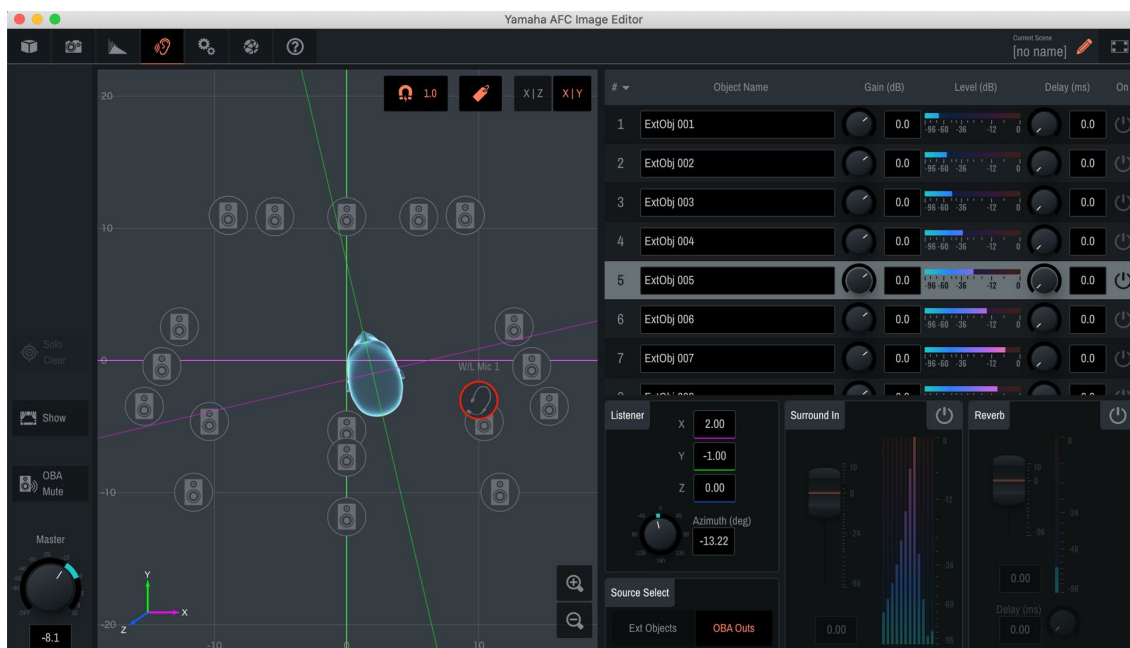

### 7.1. Listener Position (Listener)

The listening point and the orientation of the head for binaural processing can be determined. The image heard at the position and orientation will be output from the headphones.

## 7.2. Source Select

The binaural processing method can be selected from the two options.

- OBA Outs

The OBA outputs of the AFC Image will be binaurally processed. Since the speaker output after being panned by AFC Image are made binaural, the outputs will be monitored at the listening point based on the actual speaker positions.

- External Objects

Object inputs at each object position set on the Object Control window instead of speaker outputs will be binaurally processed. This can be used for another mix for streaming where different EQ, COMP, and Gain are set to each object rather than the FOH outputs of AFC image. In this case, Ext. Obj.'s position corresponds to the position set by the corresponding Obj. number. (Obj. #1 position is used for Ext. Obj. #1.)

## 7.3. External Object Input

Adjusts the gain and delay of each Ext. Obj. when Ext. Object is selected in the Source Select option.

## 7.4. Surround Input Level (Surround In)

Especially for streaming, 7.1.4 surround format can be input to add a stereophonic ambiance or other effects, which may distribute more immersive sound. This setting can adjust the level. Each 7.1.4 channel will be laid out according to ITU placement with the center that is the listening point set in Chapter 6.1. But please note that it is always fixed to the X and Y axis and not link to the head's orientation.

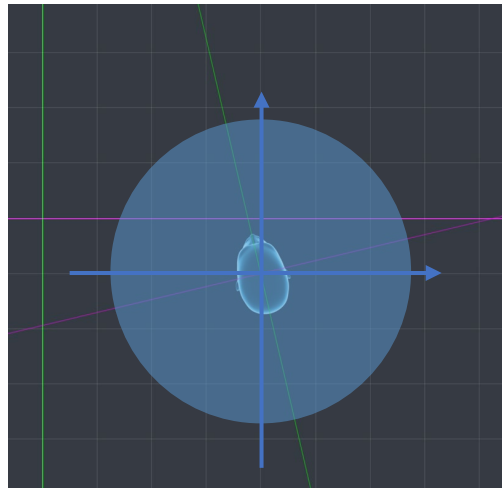

## 7.5. 3D Reverb Level (Reverb)

An additional 3D Reverb level can be set to the sources separately from the AFC Image regardless of whether the sources are external objects or OBA outs.

## 8. Saving and Loading a Project File

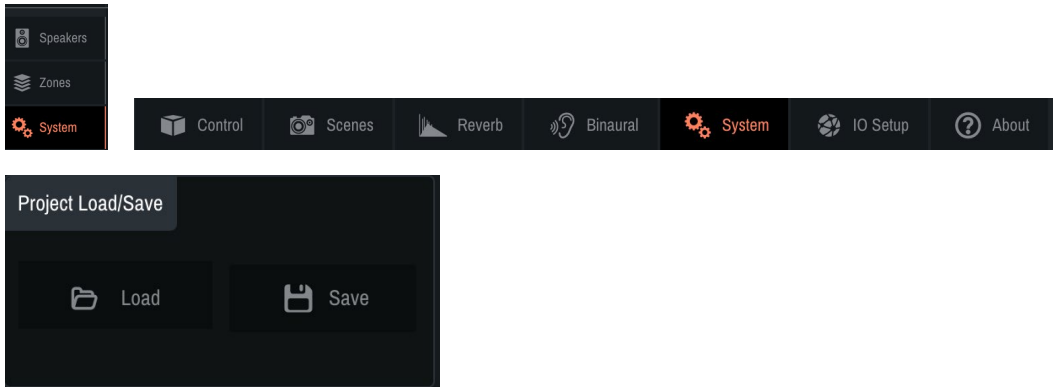

- Save: Saves the created project on the PC.
- Load: Loads a project file saved on the PC to AFC Image Editor.

### Note:

- Please do not perform any operation for about 30 seconds after a project is loaded to let the loading process complete.
- Since the current project remains as it is even after AFC Image Editor is closed, you do not need to save and load the project file to suspend and resume work in the same project.
- If the PC is online with the Kontron processor, the current project is stored in the Kontron processor. So if you want to work on a different PC, you can continue working with the same project by setting the PC and Kontron processor online with the sync direction to "Kontron Processor -> PC" and you do not need to load the project on the new PC.

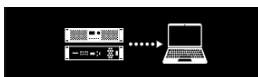

- Make sure not to delete the extension ".afcprj" when inputting the file name.

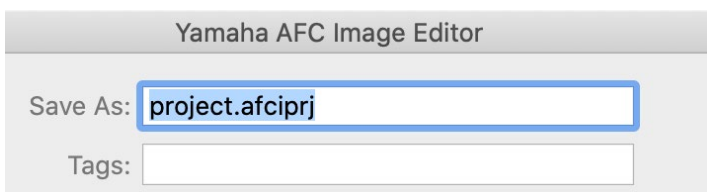

# Appendix

## Zone and Rendering Area Conversion

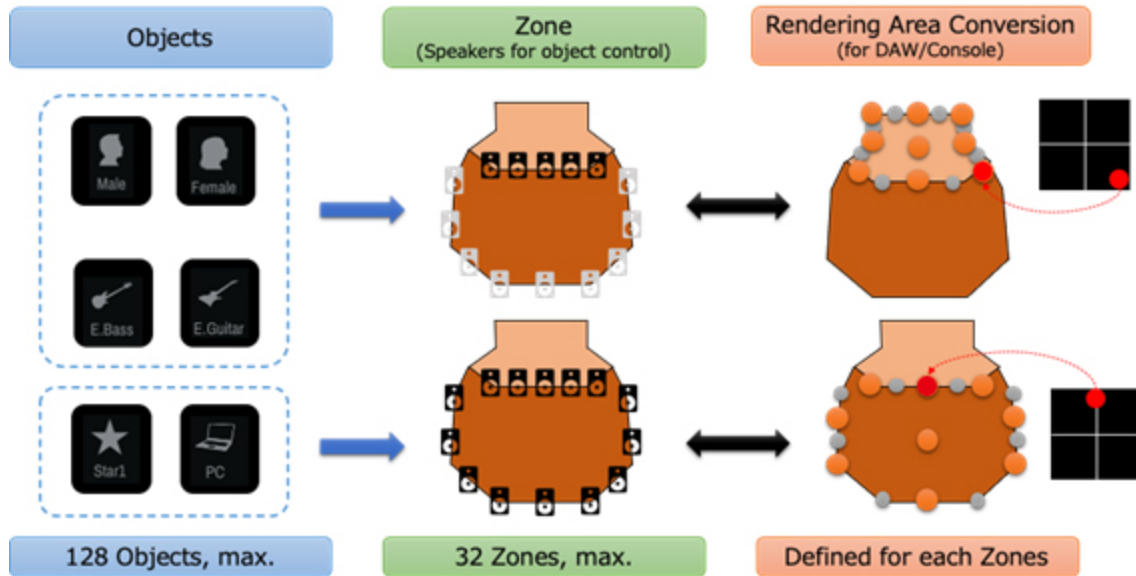

The above image shows the relationship among objects, zones, and rendering area conversion. A zone is a group of speakers for controlling the objects. For example, the above image shows that the objects with Male, Female, E.Bass, E.Guitar icons are controlled by the 5 speakers on the stage while the objects with Star1 and PC icons are controlled by the speakers around the auditorium. And if the objects are controlled by the DAW or a console, rendering area conversion determines how the defined square or cubic panning area is assigned to the rendering of AFC Image.

Up to 32 zones can be defined and each object is assigned to one of the zones. And the rendering area conversion is set to each zone.

## Rendering Area Conversion

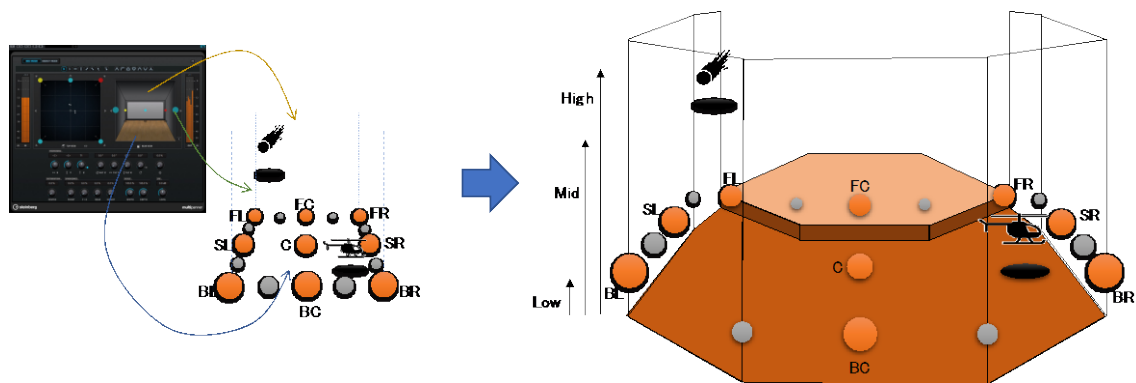

3D panning with DAW corresponds to the space controlled by AFC Image by setting the heights of Low, Mid, and High to the bottom, middle, and top of the DAW panning space respectively.

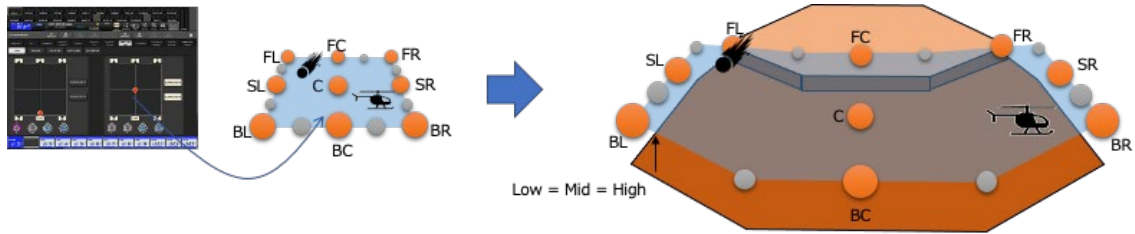

For 2D panning set by a console, etc., it can correspond to horizontal panning at the same height by setting the same value to Low, Mid, and High.

