



# EMX5000-20

POWERED MIXER

# EMX5000-12

POWERED MIXER

## Owner's Manual

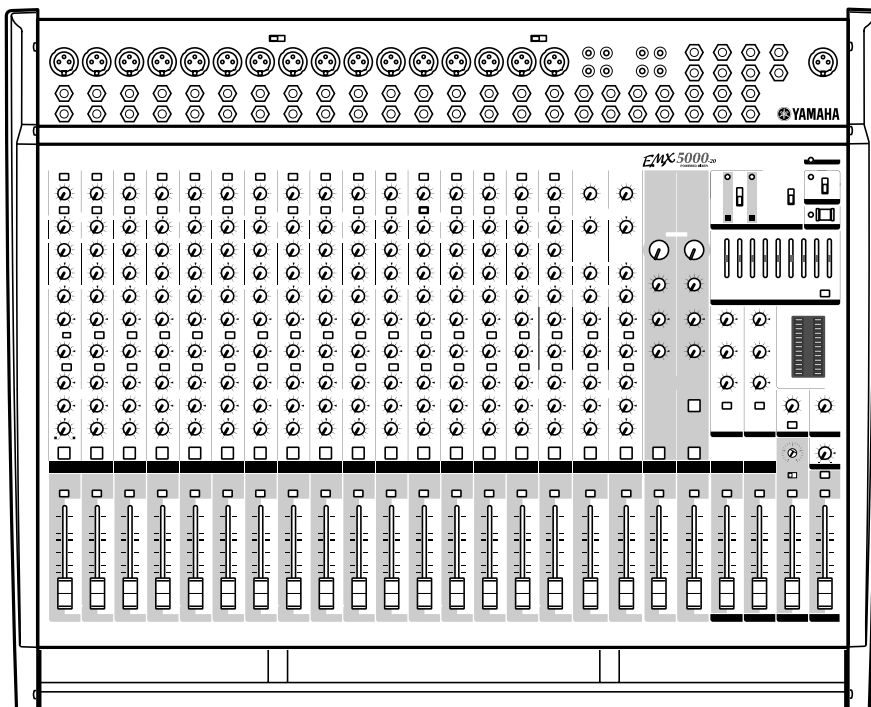

Keep This Manual For Future Reference.



# The Owner's Manual Revisions



Thank you for purchasing the Yamaha EMX5000-20/EMX5000-12 Powered Mixer. Parts of the EMX5000-20, EMX5000-12 owner's manual have been revised. Please refer to the following revisions rather than the corresponding sections of the original owner's manual.

**P.14**

**POWER amp section**

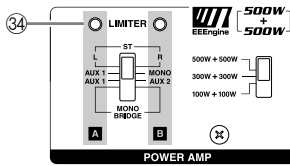

**34 LIMITER indicator**

If the output level of signals received at the SPEAKERS jacks (output of the internal power amplifier) reaches maximum, the indicator will light.

**Caution:** If the LIMITER indicator flashes continuously, the internal power amplifier section is being excessively overloaded and may malfunction. Reduce the output level at the ST OUT fader (21) below the level that the indicator flashes only briefly on the highest transient peaks.

**P.15**

**Other indicators and controls**

**40 Level Meter**

This LED display shows the level of signals received at the ST OUT jack (input/output panel 10).

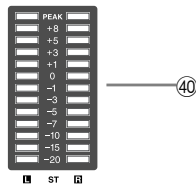

**Note:** The SPEAKERS 1 & 2 jacks (rear panel 3) output the signals received at the ST OUT jack via the internal power amplifier. Check the output signal level via the LIMITER indicator (34). The LIMITER indicator will light before the Level Meter "8" or "PEAK" LED light.

**P.18**

**Rear panel**

**3 SPEAKERS (speaker output) jacks**

These jacks are used to connect speakers. Jacks 1 are Speakon-type connectors. Use only Neutrik NL4FC plugs for connecting Speakon connectors.

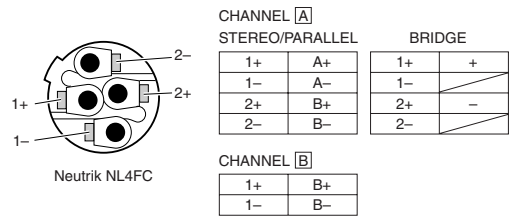

Jacks 2 are 1/4" phone jacks. The setting of the control panel power amp select switch (35) will determine the signal that is output to these jacks, and the number and appropriate impedance of the speakers that can be connected.

**P.33**

**Block/Level Diagram**

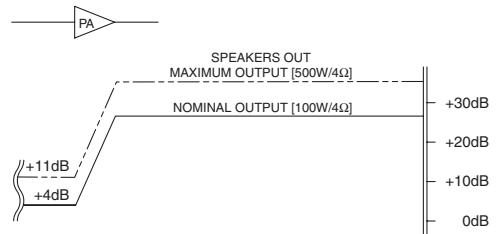

Power Amplifier output section level diagram (bottom right)

These plots show the nominal output and maximum output levels of signals received at the SPEAKERS jacks. If the output level is +4dB (Level Meter "0"), the internal power amplifier will deliver 100W into a 4Ω load. If the output level is +11dB (LIMITER indicator lights), the internal amplifier will deliver a maximum of 500W into 4Ω.

# Block/Level Diagram

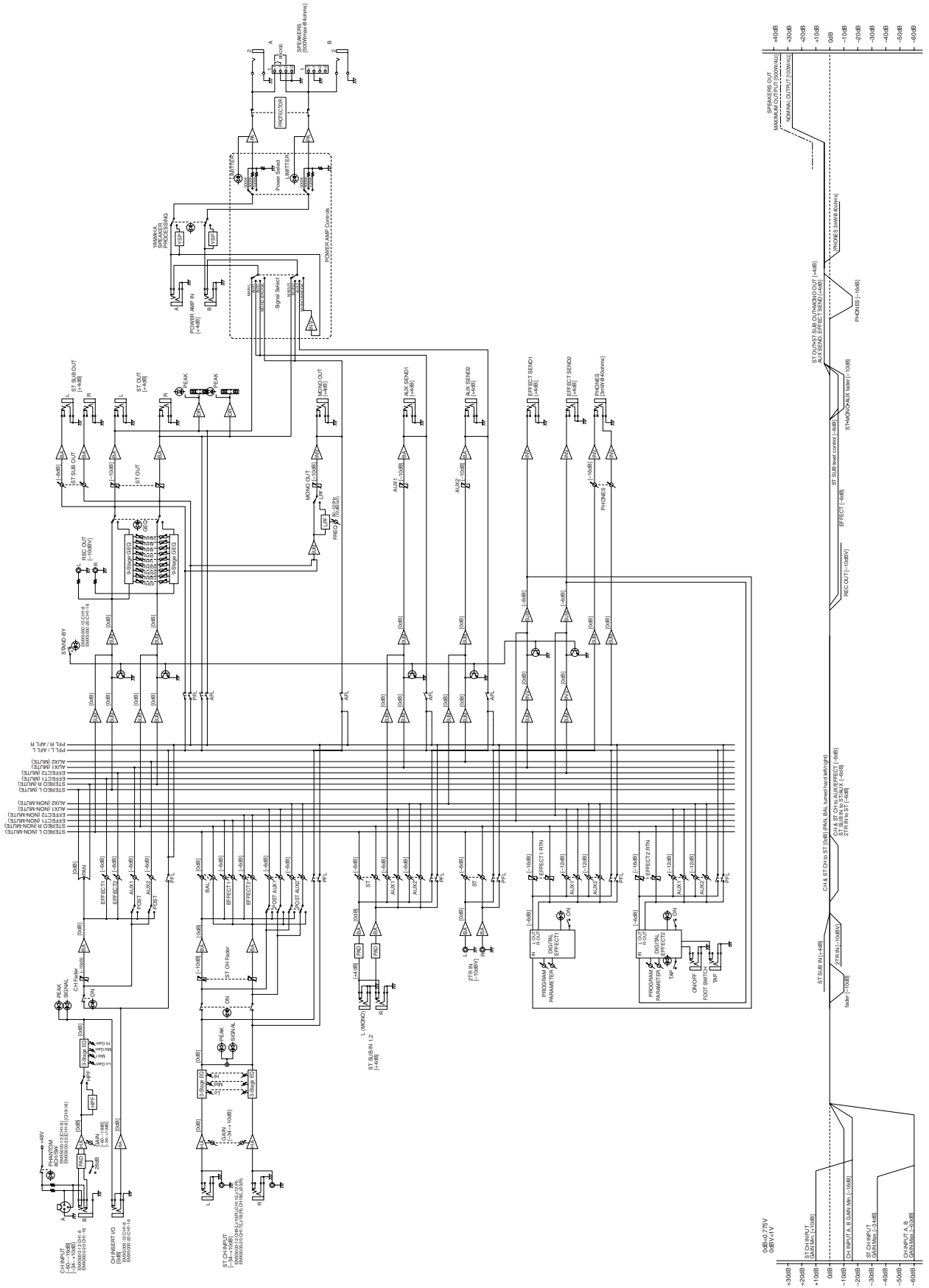

## FCC INFORMATION (U.S.A.)

1. **IMPORTANT NOTICE: DO NOT MODIFY THIS UNIT!** This product, when installed as indicated in the instructions contained in this manual, meets FCC requirements. Modifications not expressly approved by Yamaha may void your authority, granted by the FCC, to use the product.
2. **IMPORTANT:** When connecting this product to accessories and/or another product use only high quality shielded cables. Cable/s supplied with this product **MUST** be used. Follow all installation instructions. Failure to follow instructions could void your FCC authorization to use this product in the USA.
3. **NOTE:** This product has been tested and found to comply with the requirements listed in FCC Regulations, Part 15 for Class "B" digital devices. Compliance with these requirements provides a reasonable level of assurance that your use of this product in a residential environment will not result in harmful interference with other electronic devices. This equipment generates/uses radio frequencies and, if not installed and used according to the instructions found in the users manual, may cause interference harmful to the operation of other electronic devices. Compliance with FCC regulations does not guarantee that interference will not occur in all installations. If this product is found to be the source of interference, which can be determined by turning the unit "OFF" and "ON", please try to eliminate the problem by using one of the following measures: Relocate either this product or the device that is being affected by the interference. Utilize power outlets that are on different branch (circuit breaker or fuse) circuits or install AC line filter/s. In the case of radio or TV interference, relocate/reorient the antenna. If the antenna lead-in is 300 ohm ribbon lead, change the lead-in to coaxial type cable. If these corrective measures do not produce satisfactory results, please contact the local retailer authorized to distribute this type of product. If you can not locate the appropriate retailer, please contact Yamaha Corporation of America, Electronic Service Division, 6600 Orangethorpe Ave, Buena Park, CA 90620

The above statements apply **ONLY** to those products distributed by Yamaha Corporation of America or its subsidiaries.

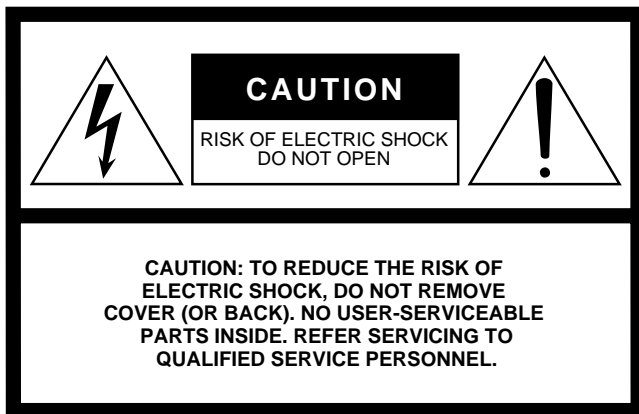

The above warning is located on the rear of the unit.

## • Explanation of Graphical Symbols

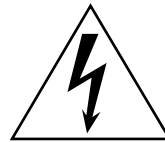

The lightning flash with arrowhead symbol within an equilateral triangle is intended to alert the user to the presence of uninsulated "dangerous voltage" within the product's enclosure that may be of sufficient magnitude to constitute a risk of electric shock to persons.



The exclamation point within an equilateral triangle is intended to alert the user to the presence of important operating and maintenance (servicing) instructions in the literature accompanying the product.

WARNING: THIS APPARATUS MUST BE EARTHED

### IMPORTANT

THE WIRES IN THIS MAINS LEAD ARE COLOURED IN ACCORDANCE WITH THE FOLLOWING CODE:

GREEN-AND-YELLOW : EARTH  
 BLUE : NEUTRAL  
 BROWN : LIVE

As the colours of the wires in the mains lead of this apparatus may not correspond with the coloured markings identifying the terminals in your plug, proceed as follows:

The wire which is coloured GREEN and YELLOW must be connected to the terminal in the plug which is marked by the letter E or by the safety earth symbol  $\perp$  or coloured GREEN and YELLOW.

The wire which is coloured BLUE must be connected to the terminal which is marked with the letter N or coloured BLACK.

The wire which is coloured BROWN must be connected to the terminal which is marked with the letter L or coloured RED.

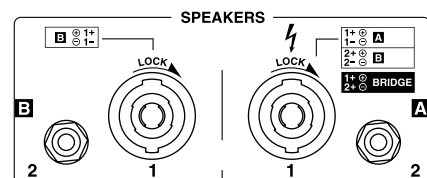

### European Specifications Only

This ⚡ mark indicates a dangerous electrically live terminal. When connecting an external wire to this terminal, it is necessary either to have "a person who have received appropriate guidance on handling" make the connection or to use leads or a cord that have been manufactured in such a way that the connection can be made simply and without problem.

\* This applies only to products distributed by YAMAHA KEMBLE MUSIC (U.K.) LTD.

# Precautions

## WARNING

### Installation

- Connect this unit's power cord only to an AC outlet of the type stated in this Owner's Manual or as marked on the unit. Failure to do so is a fire and electrical shock hazard.
- Do not allow water to enter this unit or allow the unit to become wet. Fire or electrical shock may result.
- Do not place a container with liquid or small metal objects on top of this unit. Liquid or metal objects inside this unit are a fire and electrical shock hazard.
- Do not place heavy objects, including this unit, on top of the power cord. A damaged power cord is a fire and electrical shock hazard. In particular, be careful not to place heavy objects on a power cord covered by a carpet.
- Use only the included power cord for this unit. Using other types may be a fire and electrical shock hazard.
- The power to this device is not completely shut off even when the power switch is turned off. Locate the device close to the AC outlet so you can easily reach the power plug.

### Operation

- Do not scratch, bend, twist, pull, or heat the power cord. A damaged power cord is a fire and electrical shock hazard.
- Do not remove the unit's cover. You could receive an electrical shock. If you think internal inspection, maintenance, or repair is necessary, contact your dealer.
- Do not modify the unit. Doing so is a fire and electrical shock hazard.
- If lightning begins to occur, turn off the power switch of the unit as soon as possible, and unplug the power cable plug from the electrical outlet.
- If there is a possibility of lightning, do not touch the power cable plug if it is still connected. Doing so may be an electrical shock hazard.

### In case an abnormality occurs during operation

- If the power cord is damaged (i.e., cut or a bare wire is exposed), ask your dealer for a replacement. Using the unit with a damaged power cord is a fire and electrical shock hazard.
- Should this unit be dropped or the cabinet be damaged, turn the power switch off, remove the power plug from the AC outlet, and contact your dealer. If you continue using the unit without heeding this instruction, fire or electrical shock may result.
- If you notice any abnormality, such as smoke, odor, or noise, or if a foreign object or liquid gets inside the unit, turn it off immediately. Remove the power cord from the AC outlet. Consult your dealer for repair. Using the unit in this condition is a fire and electrical shock hazard.

## CAUTION

### Installation

- Keep this unit away from the following locations:
  - Locations exposed to oil splashes or steam, such as near cooking stoves, humidifiers, etc.
  - Unstable surfaces, such as a wobbly table or slope.
  - Locations exposed to excessive heat, such as inside a car with all the windows closed, or places that receive direct sunlight.
  - Locations subject to excessive humidity or dust accumulation.
- Hold the power cord plug when disconnecting it from an AC outlet. Never pull the cord. A damaged power cord is a potential fire and electrical shock hazard.
- Do not touch the power plug with wet hands. Doing so is a potential electrical shock hazard.
- This unit has ventilation holes at the rear to prevent the internal temperature rising too high. Do not block them. Blocked ventilation holes are a fire hazard.
- To relocate the unit, turn the power switch off, remove the power plug from the AC outlet, and remove all connecting cables. Damaged cables may cause fire or electrical shock.

### Operation

- Turn off all musical instruments, audio equipment, and speakers when connecting to this unit. Use the correct connecting cables and connect as specified.
- Always lower the volume control to minimum before turning on the power to this unit. A sudden blast of sound may damage your hearing.
- Use only speaker cables when connecting speakers to amplifier outputs. Using other types of cables is a fire hazard.
- If you know you will not use this unit for a long period of time, such as when going on vacation, remove the power plug from the AC outlet. Leaving it connected is a potential fire hazard.

### Maintenance

- Clean the contacts of the phone plug before connecting it to the SPEAKERS jack of this unit. Dirty contacts may generate heat.
- To prevent electrical shock when cleaning the unit, remove the power plug from the AC outlet.

**PRECAUTIONS FOR OPERATION****– FOR CORRECT OPERATION –****Connector pin assignments**

- XLR-type connectors are wired as follows: pin 1: ground, pin 2: hot (+), and pin 3: cold (–).
- Insert TRS phone jacks are wired as follows: sleeve: ground, tip: send, and ring: return.

**Replacing abrasive parts**

- The performance of components with moving contacts, such as switches, rotary controls, faders, and connectors, deteriorates over time. The rate of deterioration depends on the operating environment and is unavoidable. Consult your dealer about replacing defective components.

**Influence on cell phone usage**

- Using a cell phone (mobile telephone) near this unit may induce noise. If noise occurs, use the telephone away from the unit.

**Volume level setting**

- Do not set all equalizer controls and faders to maximum. Doing so may cause oscillation depending on the condition of the connected unit and speakers, and may damage the speakers.

**Interference with other electronic devices**

- The digital circuits of this unit may induce a slight noise into nearby radios and TVs. If noise occurs, relocate the affected equipment.

## Introduction

Thank you for purchasing the Yamaha EMX5000-20/EMX5000-12 Powered Mixer. In order to take full advantage of the EMX5000-20/EMX5000-12 and enjoy long, trouble-free performance, please read this owner's manual carefully, and keep it in a safe place for future reference.

## Features

- The EMX5000-20/EMX5000-12 provides versatile inputs, such as two stereo input channels and two stereo sub inputs, as well as 16 (EMX5000-20), 8 (EMX5000-12) monaural input channels compatible with mic/line signals. The mixer also has ample power, with a maximum output of 500 W+500 W (1000 W with bridge connection), and is suitable for a wide range of applications from installed systems to small-scale PA systems.
- A two-channel power amp is built-in. The signals output to speakers can be selected as stereo (ST L-R), AUX+monaural (AUX 1- MONO), two AUX (AUX1-AUX2) or monaural (bridge connection).
- In addition to the speaker output jacks, two stereo output channels for line-level signals, two AUX output channels, two effect outputs, and one monaural output are provided. You can easily expand the system by adding a power amplifier or powered speakers.
- The EMX5000-20/EMX5000-12 also has a PHONES jack, which is very useful for checking the sound. You can monitor only a specific channel or bus signal through the headphones.
- Each amp contains a limiter circuit to prevent distortion due to excessive input levels.
- A maximum output select switch lets you switch the maximum output of the amp between three levels. This lets you adjust the maximum output of the internal power amp as appropriate for the size of the room or the input capacity of the speakers.
- Two multi-effect units are built-in, each providing sixteen types of effect equivalent in quality to the acclaimed Yamaha SPX series of multi-effect units. The effects can be used to add reverb or ambience to vocals or instruments. The sixteen types (provided by each of the two effect units) include TAP DELAY, which lets you easily adjust the delay time.
- The EMX5000-20/EMX5000-12 has implemented “EEEngine”, Yamaha’s epochal amp drive technology to create an unrivaled high-efficiency drive. The EEEngine’s energy-saver/low-heat-generation design has reduced power consumption to 50% or less, and reduced heat generation to 35% or less (in field applications, compared to Yamaha’s previous models), and has led to a reduction in energy cost and to less-restrictive installation requirements related to heat generation.

## Contents

Introduction .....	5
Features .....	5
EMX5000-20/EMX5000-12 Quick Guide .....	6
Front and rear panel.....	10
Control panel .....	10
Input/output panel.....	16
Rear panel .....	18
Installation/Connections .....	19
Installation .....	19
Connection .....	19
Connecting input/output equipment.....	21
Basic operation .....	22
Connecting microphones and instruments .....	22
Using the digital effect .....	22
Example setups.....	24
As a conference/entertainment hall sound system.....	24
As a band PA.....	26
Using a subwoofer .....	28
Troubleshooting .....	29
Specifications .....	30
General specifications .....	30
Input specifications .....	31
Output specifications .....	31
Dimensions .....	32
Installing an optional rack mount kit .....	32
Block/Level Diagram.....	33

# EMX5000-20/ EMX5000-12 Quick Guide

The following steps (1–5) explain the basic connection and operation of the EMX5000-20/EMX5000-12.

Also, please read “Front and Rear Panel” and “Basic Operation” following this Quick Guide section to learn more about using the EMX5000-20/EMX5000-12.

## STEP 1 Connection

### Connecting speakers

Using speaker cables, connect each speaker to the SPEAKERS A jack and to the B jack in the SPEAKERS jack section on the rear panel of the EMX5000-20/EMX5000-12.

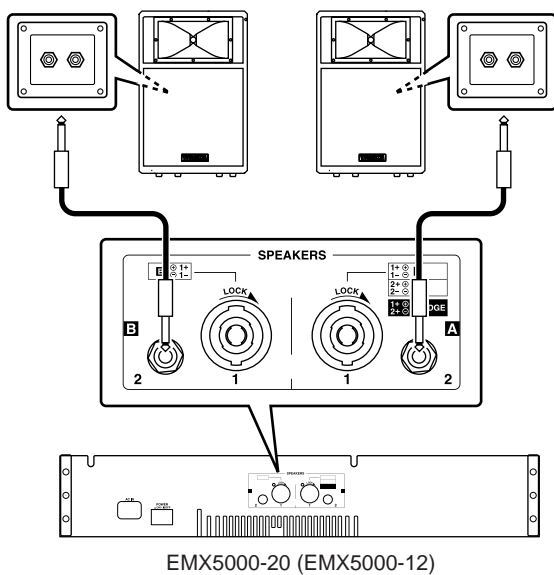

- In the example shown by the above diagram, two main speakers are connected (one each to left and right) in stereo. For other connection examples, refer to pages 20–21.
- You may connect to either of the two jacks on the speakers.
- Be sure to use a cable designed for speaker connection.
- Speakers with a Speakon connector can also be connected using a Speakon cable. In this case, use the SPEAKERS 1 jacks to output the signal from the EMX5000-20/EMX5000-12.
- When connecting a Speakon connector to the EMX5000-20/EMX5000-12, be sure to turn the plug to the right to lock the connection after inserting the plug.

Never connect the speakers in the manner shown below. Otherwise, the EMX5000-20/EMX5000-12's built-in power amplifier will be damaged.

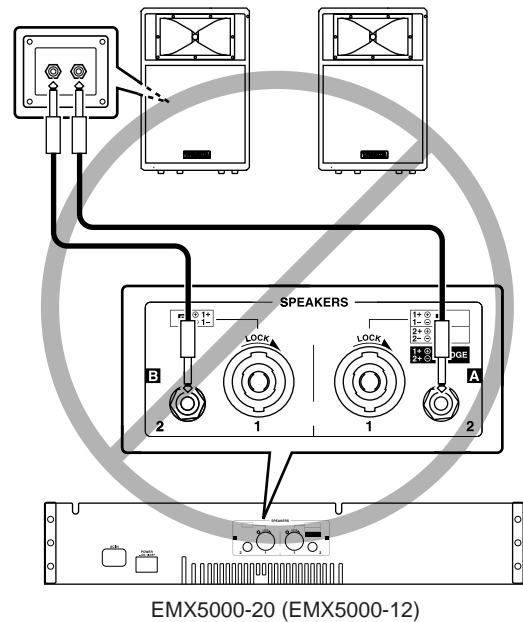

### Setting the power amplifier mode

Set the power amp select switch (located on the right corner on the panel) to ST L-R.

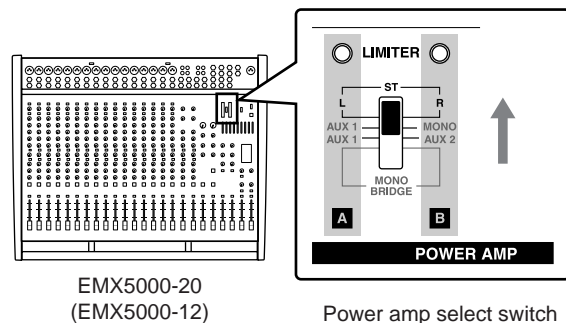

- This quick guide explains how to connect one main speaker each to left and right for stereo operation. If the power amp select switch is set to the ST L-R position as shown here, the stereo R signal will be output from the SPEAKERS A jacks, and the stereo L signal from the SPEAKERS B jacks. Refer to pages 14, 19, 20 for other connections and power amp select switch settings.



### Connecting a microphone

Make sure that the power is turned off to the EMX5000-20/EMX5000-12.

Connect mics to channels 1–16 (EMX5000-20) or 1–8 (EMX5000-12), using the INPUT A jacks if the mic has an XLR plug, or the INPUT B jacks if the mic has a phone plug.

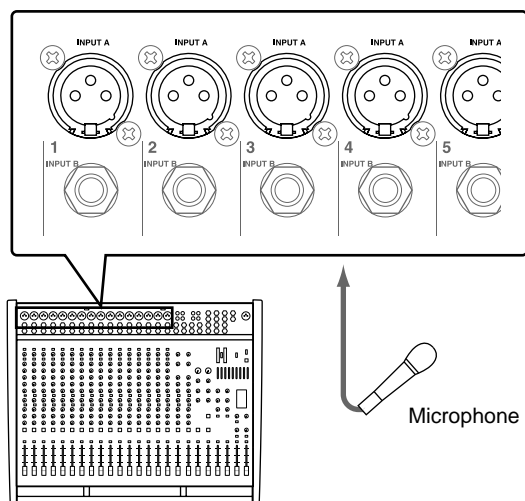

EMX5000-20 (EMX5000-12)

### Using a condenser microphone

Turn on the PHANTOM switch (located in the upper center corner on the panel).

- The PHANTOM switch supplies phantom power to all channel inputs at once (EMX5000-20: 1–8 and 9–16, EMX5000-12: 1–8), so mics other than condenser mics must be connected to the INPUT B jacks.

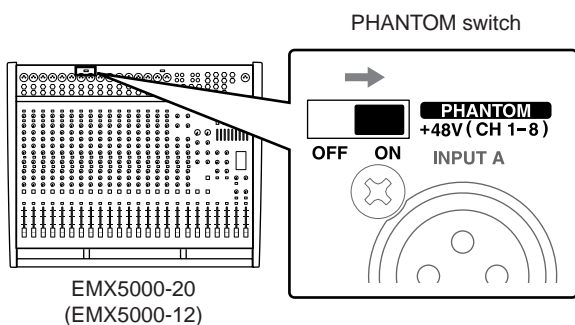

- Do not connect or disconnect a condenser microphone while the power to the unit is on and the PHANTOM switch has been turned on.

### Connecting a CD player, MD player, and/or cassette deck

Connect a CD player or MD player to the 2TR IN jacks. Refer to the operation manual of the corresponding device for more information on the input and output of the device.

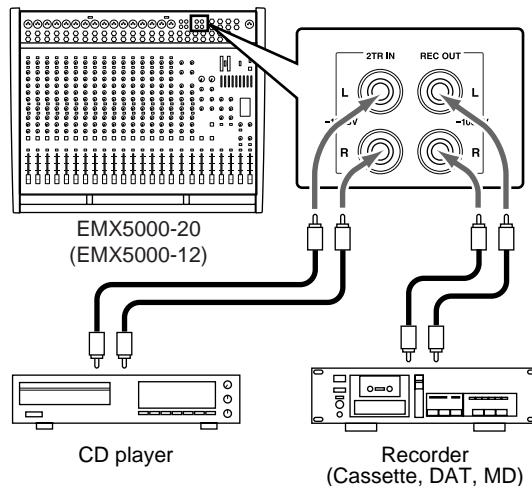

- To connect a second player, use the LINE jack.
- Connect a recorder to the REC OUT jacks.

### Connecting an electric acoustic guitar or electric bass

Connect electric/acoustic guitars or electric basses via an effect processor or direct box to the INPUT B jack.

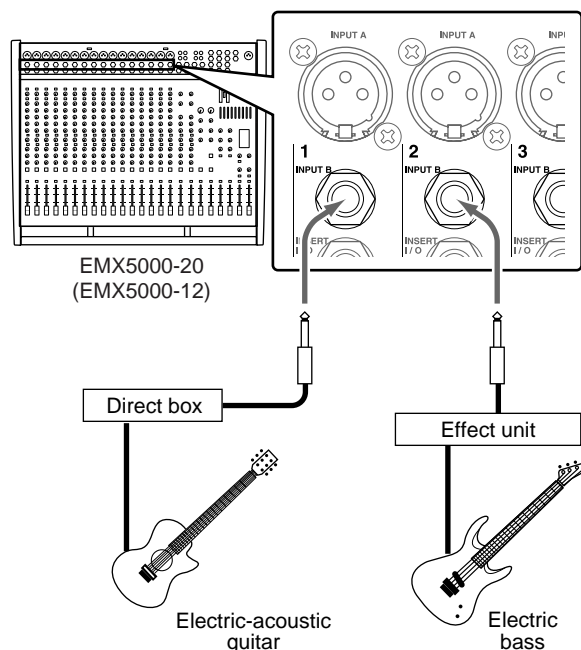

- You cannot use the INPUT A jack and the INPUT B jack for the same channel at the same time. If a microphone has already been connected to the INPUT B jack of a channel, you cannot connect the effect unit to the INPUT A jack of the channel.

### Connecting an electronic musical instrument

To the EMX5000-20/EMX5000-12's LINE or ST SUB IN jacks, you can connect an electronic musical instrument such as a synthesizer, drum machine, signal processor connected to an electric guitar, etc. Refer to the diagram below to make a stereo connection from the output jacks (such as L/MONO and R) of an electronic musical instrument to the LINE or ST SUB IN jacks in stereo.

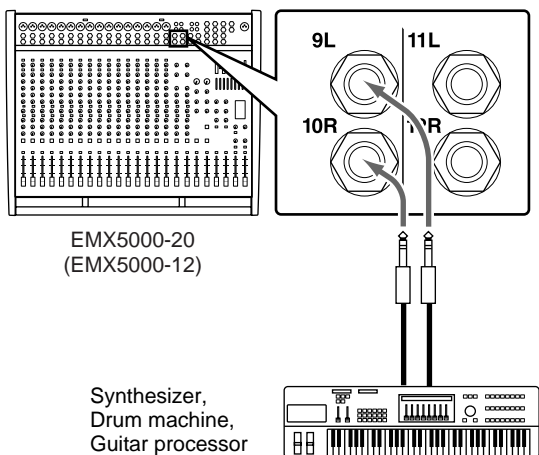

### STEP 2 Power on

- 1 Turn on the power to all external devices connected to the EMX5000-20/EMX5000-12.
- 2 Make sure that the ST OUT fader of the EMX5000-20/EMX5000-12 is lowered, and then press the POWER switch of the EMX5000-20/EMX5000-12 to turn it on.

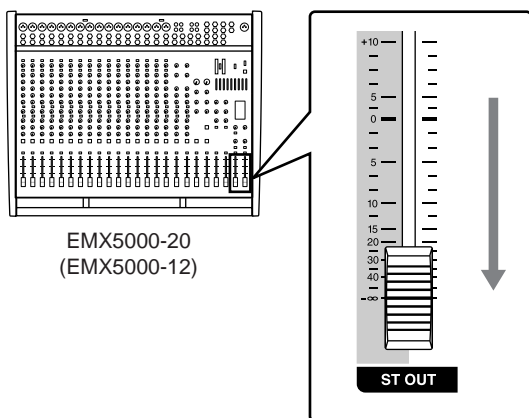

- Be sure to follow the power up sequence specified above to prevent the speakers from being damaged.
- To correct the low range, turn on the YAMAHA SPEAKER PROCESSING switch in the upper right corner of the panel.

### STEP 3 Sound output

Set the ST OUT fader and the input channel faders to the “ $-\infty$ ” position, and while playing the instrument (or singing into the mic) connected to the channel you want to check, raise the GAIN control of the channel so that the PEAK indicator of that channel lights occasionally.

- Do not press the 26dB PAD switch if sound is input from the microphone. Otherwise, press the 26dB PAD switch on.

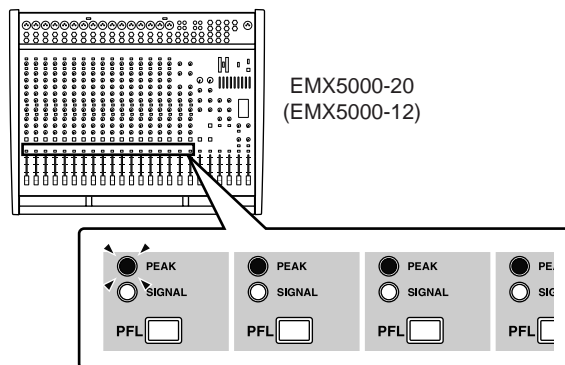

Set the ST OUT fader to the “0” position, and raise the faders of the input channels to adjust the volume.

- Please be aware that if the PEAK indicator of the ST level meter is continuously lit for an extended time, the internal amp or the connected speakers may be damaged.

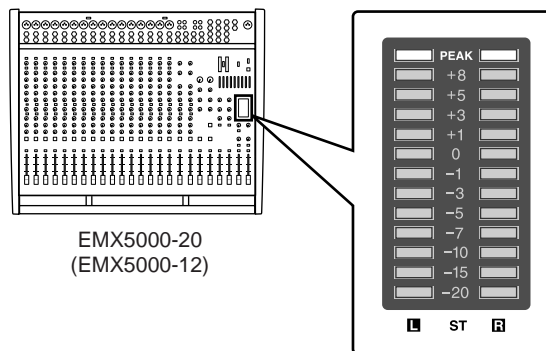

Use the ST OUT fader to adjust the volume of the speakers.

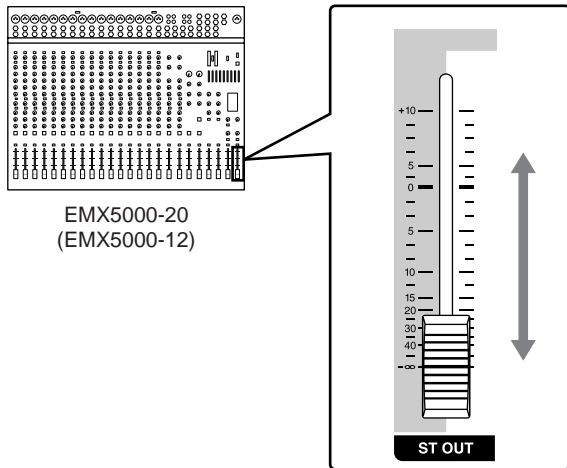

3 Set the EFFECT RTN fader to the “0” position.

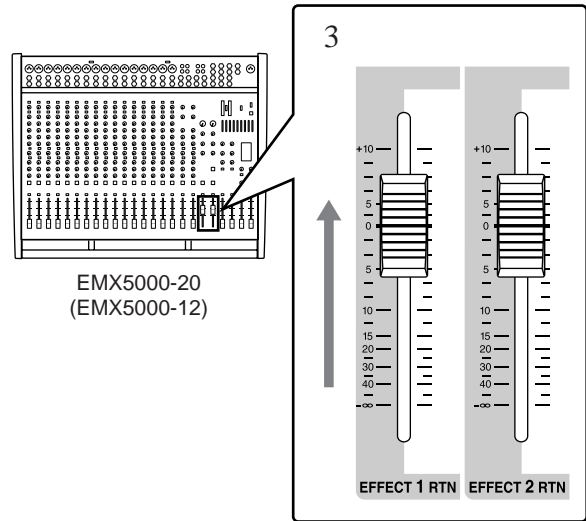

#### STEP 4 Applying built-in effects

- 1 Use the PROGRAM selector to select the type of effect that you want to apply.
- 2 Turn on the ON switch in the EFFECT section. The ON switch indicator lights up.

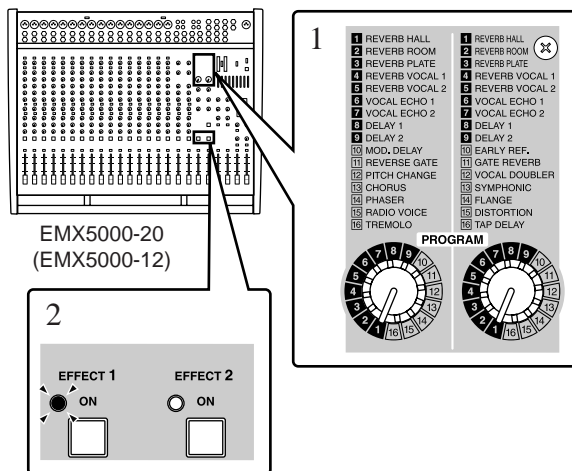

4 If you want to use effect channel 1, adjust the effect depth by turning the EFF1 control of the channel to which you want to apply the effect.

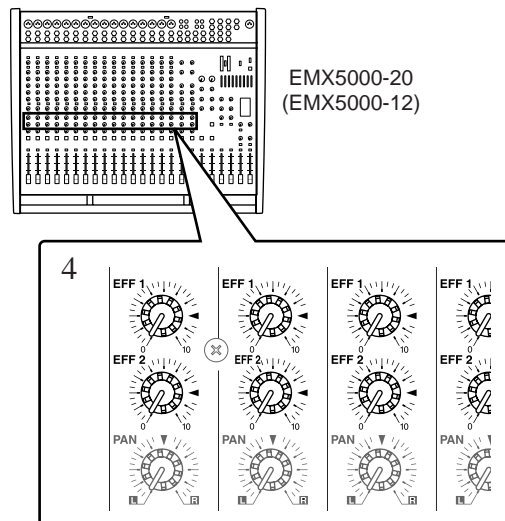

#### STEP 5 Power off

- 1 Press the POWER switch of the EMX5000-20/EMX5000-12 to turn off the power to the unit.
- 2 Turn off the power to all connected devices.

- Be sure to follow the power off sequence specified above to prevent the speakers from being damaged.
- In preparation for the next time you will use the EMX5000-20/EMX5000-12, we recommend that you set the faders of the EMX5000-20/EMX5000-12 to the “-∞” position.

# Front and rear panel

## Control panel

### ■ Channel control section

In this section, you can adjust equalization (frequency response), volume level, effect and AUX output levels for the input signal of each channel.

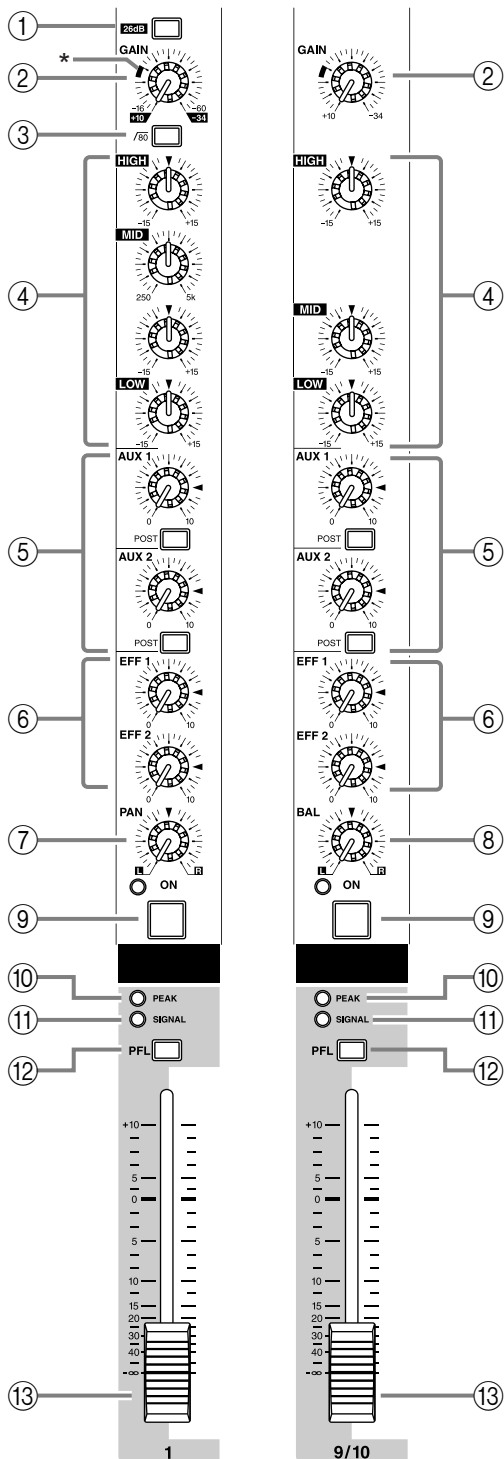

#### ① 26 dB pad switch

This switch attenuates the input signal by 26 dB. Attenuation is on when the switch is pressed inward.

#### ② GAIN control

Use this knob to adjust the sensitivity according to the input signal level, so that the input level is appropriate.

For the best balance of S/N ratio and dynamic range, adjust this knob so that the peak indicator ⑩ lights occasionally.

\* When the knob is at the “” position, the input sensitivity will be +4 dB.

#### ③ $\sqrt{80}$ (High pass filter) switch

This is an on/off switch for the high-pass filter. The high-pass filter is on when the switch is pressed inward, and the frequency region below 80 Hz will be attenuated at 18 dB/octave.

#### ④ Equalizer controls (HIGH, MID, LOW)

This is a 3-band equalizer that adjusts the high frequency range, mid frequency range, and low frequency range of each channel.

When the HIGH and LOW knobs are in the “” position, the high and low ranges will have a flat response. Turning a knob toward the right will boost the corresponding frequency range, and turning it toward the left will cut it.

For the mid range, use the upper MID knob to specify the center frequency of the range, and use the lower knob to set the amount of boost or cut that will occur. The frequency response is flat when the lower knob is set to the “” position. Turning the lower knob toward the right will boost the corresponding frequency range, and turning the knob toward the left will cut it.

The base frequency (or center frequency), range of boost or cut, and equalizer type of each band are as follows:

HIGH:	10kHz, $\pm 15$ dB,	shelving type
MID:	250Hz–5kHz, $\pm 15$ dB,	peaking type
LOW:	100Hz, $\pm 15$ dB,	shelving type

### ⑤ AUX1, AUX2 controls / POST switches

These knobs adjust the level at which the input signal will be sent to the AUX1 and 2 buses. Nominal level is when the knob is set to the “◀” position. The position from which the signal is sent can be set by the POST switch to either pre-fader (before the channel fader ⑬) or post-fader (after the channel fader ⑬). When the switch is pressed inward, post-fader is selected.

The signal will be output from the AUX1 and 2 buses to the AUX SEND 1 and 2 jacks of the input/output section, and can be sent to external monitor amps or powered speakers.

### ⑥ EFF 1, 2 controls (EFFECT)

For each channel, these control the amount of signal that is sent to the EFFECT 1, 2 buses.

The signal of the EFFECT 1, 2 buses is sent to the EFFECT SEND 1, 2 jack (input/output panel ⑨). It is also sent to the built-in effect when the ON switch ⑳ in the digital effect section is turned on.

*Note:* The amount of signal that is sent to the EFFECT 1, 2 bus from each channel will be affected not only by the setting of the EFFECT 1, 2 control, but also by the setting of the channel fader ⑬ (post-fader send).

### ⑦ PAN (panpot) control (EMX5000-20: Channels 1–16, EMX5000-12: Channels 1–8)

The PAN knobs set the stereo position of the signal that is sent to the STEREO bus. The signal is located in the center when the knob is positioned at “▼,” at right at R, and at left at L.

### ⑧ BAL (balance) control (EMX5000-20: Channels 17/18–19/20, EMX5000-12: Channels 9/10–11/12)

The BAL knobs set the balance between the left and right channels, and assign the signals received at inputs 17/18–19/20, 9/10–11/12 to the STEREO bus.

### ⑨ ON switch, indicator

This is an on/off switch for the input signal of each channel. The indicator will light if this switch is turned on.

### ⑩ PEAK indicator

The indicator will light 3 dB before clipping, warning that clipping level is near.

### ⑪ SIGNAL indicator

This indicator will light if a signal is being input to the corresponding channel.

### ⑫ PFL (pre-fader listen) switch

Channels for which this switch is on will send a signal from a post-EQ pre-fader location to the PHONES jack (input/output panel ⑭). Use this when you wish to use the headphones to monitor only a specific channel.

*Note:* If this switch is turned on, you can monitor a channel even if the channel fader is lowered, or if the ON switch is off. This will not affect the signals that are sent to the STEREO bus, AUX 1 and 2 buses, and EFFECT bus.

### ⑬ Channel fader

This controls the output level of the input channel signal.

### ⑭ PHANTOM indicator

This will light when the PHANTOM switch (input/output panel ③) is on.

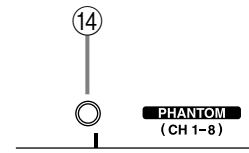

## ■ Stereo sub input section

In this section, you can adjust the input level of external equipment connected to the ST SUB IN 1, 2 jacks on the input/output panel.

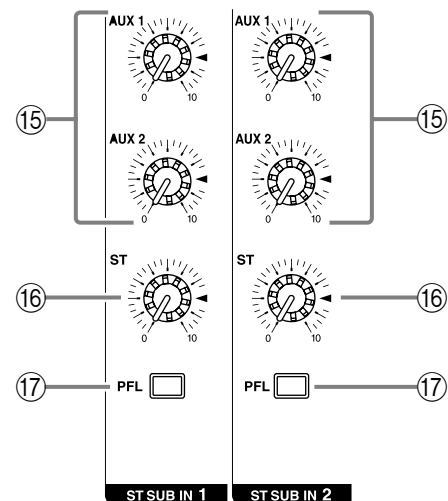

### ⑮ AUX 1, 2 controls

This knob adjusts the amount of the signal sent from the ST SUB IN 1 and 2 jacks (input/output panel ⑦) to the AUX 1, 2 buses.

### ⑯ ST (stereo) control

The ST knob adjusts the amount of stereo signal sent from the ST SUB IN 1 and 2 jacks to the STEREO bus.

**17 PFL (pre-fader listen) switch**

When this switch is turned on, the signal at the point before the ST control knob (16) is sent to the PHONES jack (input/output panel 14).

*Note:* The ST control setting does not affect the level of the signal sent to the PFL/AFL buses (pre-fader send).

**Master control section**

In this section, you can adjust the final level of the outputs.

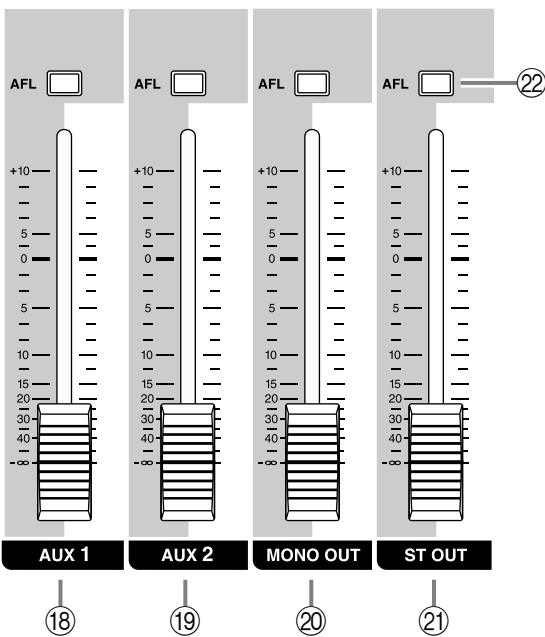

**18 AUX 1 fader**

The AUX 1 fader adjusts the final level of the signal sent from the AUX 1 bus to the AUX SEND 1 jack (input/output panel 8). If the Power amp select switch (35) is set to AUX 1-MONO, using this fader enables you to adjust the level of the signal sent from the SPEAKERS A 1/2 jacks to the speakers.

**19 AUX 2 fader**

The AUX 2 fader adjusts the final level of the signal output from the AUX 2 bus to the AUX SEND 2 jack (input/output panel 8). If the Power amp select switch (35) is set to AUX 1-AUX 2, using this fader enables you to adjust the level of the signal sent from the SPEAKERS B 1/2 jacks to the speakers.

**20 MONO OUT fader**

The MONO OUT fader adjusts the final level of the monaural signal output from the STEREO bus to the MONO OUT jack (input/output panel 13).

If the Power amp select switch (35) is set to AUX 1-MONO, this fader also adjusts the level of the signal sent from the SPEAKERS B 1/2 jacks to the speakers.

If the Power amp select switch (35) is set to MONO BRIDGE, this fader adjusts the level of the signal sent from the SPEAKERS A 1 jacks to the speaker.

**21 ST OUT fader**

The ST OUT fader adjusts the final level of the signal sent from the STEREO bus to the ST OUT jacks (input/output panel 10). If the Power amp select switch (35) is set to ST L-R, this fader also adjusts the level of the signal sent to the SPEAKERS jacks (rear panel 3).

*Note:* The setting of this fader does not affect the signal output from the STEREO bus to the ST SUB OUT jacks.

**22 AFL (after fader listen) switch**

When this switch is on, the output signal that passes through the corresponding fader is sent to the PHONES jack (input/output panel 14). Use these switches when you wish to monitor a particular output signal through the headphones.

**2TR IN section**

In this section, you can adjust the input level of a cassette deck or a CD player that is connected to the 2TR IN jacks (input/output panel 5).

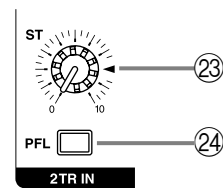

**23 ST (stereo) control**

This knob adjusts the level of the signal sent from the 2TR IN jacks to the STEREO bus.

**24 PFL (pre-fader listen) switch**

When this switch is on, the signal input from the 2TR IN jacks is routed at the point before the ST control (23) to the PHONES jack (input/output panel 14).

## ■ Digital effect section

This section enables you to turn the built-in two-channel digital effects on/off and select the effect type.

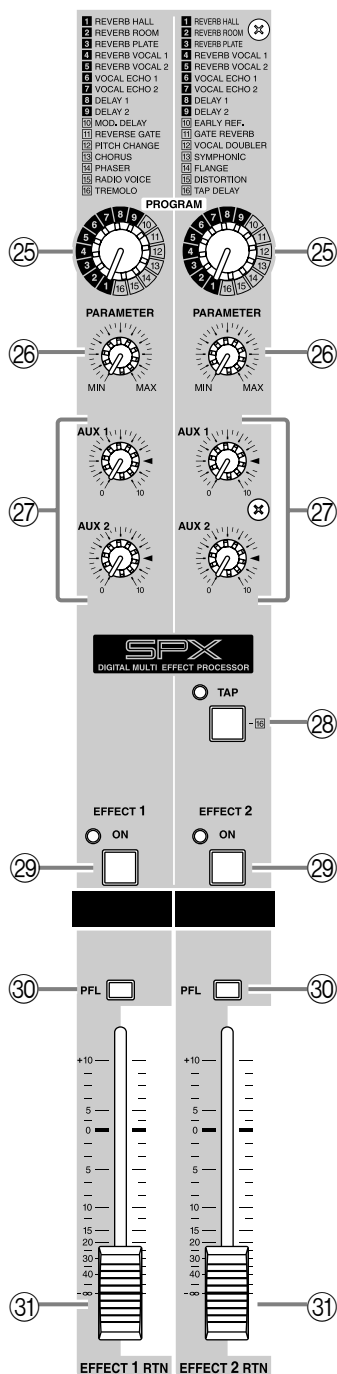

### ②5 PROGRAM selector

This knob selects the effect type for the internal digital effect.

### ②6 PARAMETER control

This knob adjusts the time parameter of the internal digital effect.

### ②7 AUX 1/2 control

This knob adjusts the level of the return signal that is sent from the built-in digital effect to the AUX 1/2 buses.

### ②8 TAP switch, indicator

Only if the PROGRAM selector has selected 16 TAP DELAY as the internal effect type, you can press this switch to set the desired delay time.

Press the TAP switch several times, and the interval between the last two presses will be set as the delay time. The specified time will be remembered even if the power is turned off.

The LED beside the switch will blink in synchronization with the delay time only when the effect type is TAP DELAY.

### ②9 EFFECT 1/2 ON switch

This switch turns the internal digital effect on/off.

### ③0 PFL (Pre-fader listen) switch

When this switch is on, the signal from before the EFFECT 1/2 RTN faders 31 will be sent to the PHONES jack (input/output panel 14).

### ③1 EFFECT 1/2 RTN fader

This fader adjusts the level of the return signal that is sent from the built-in digital effect to the STEREO bus.

## ■ Graphic equalizer section

This section enables you to adjust the tone of the STEREO bus signal.

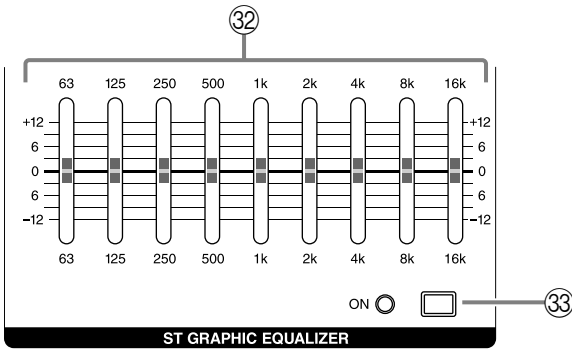

### 32 Graphic equalizer

This is a 9-band graphic equalizer that allows you to adjust the frequency response of the STEREO bus signal, providing a maximum of  $\pm 12$  dB of cut/boost for each frequency band.

This graphic equalizer affects both the STEREO bus signal that is output to the speakers and the line level signal that is output from the ST OUT jacks (input/output panel 10), and MONO OUT jack (input/output panel 13).

### 33 ON switch

This switch turns the graphic equalizer on/off.

## ■ Power amp section

This section allows you to select the signals that will be sent to the built-in two-channel power amplifier.

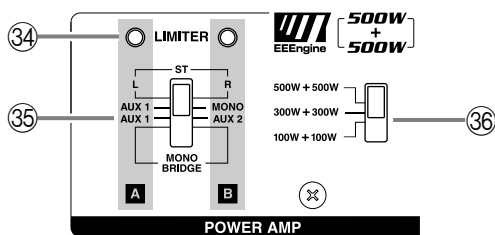

### 34 LIMITER indicator

This indicator lights up when the level of the signal output from the power amp section reaches the maximum and the limiter is activated. Adjust the ST OUT 21 and appropriate fader so that the indicator lights up for only a short while when the signal reaches the maximum level.

*Note:* The indicator lights up or flashes for a longer duration if the power amp section is significantly overloaded, which could result in malfunction. Avoid such a situation.

### 35 Power amp select switch

Select one of the following three settings to specify the signals to be routed to the corresponding jacks according to the speaker connection at the SPEAKERS jacks 3 on the rear panel.

- **ST L-R**

The STEREO bus signals are output from the SPEAKERS A 1/2 jacks and the SPEAKERS B 1/2 jacks. The final level of these signals is adjusted by the master ST OUT fader.

- **AUX 1-MONO**

The AUX 1 bus signals are output from the SPEAKERS A 1/2 jacks, and a monaural signal that is a mix of the STEREO bus signals is output from the SPEAKERS B 1/2 jacks. The final level of these signals is adjusted by the master AUX 1 fader and the MONO OUT fader.

- **AUX 1-AUX 2**

The AUX 1, 2 buses signals are output from the SPEAKERS A 1/2 jacks and the SPEAKERS B 1/2 jacks.

- **MONO BRIDGE**

The monaural signal that is a mix of the STEREO bus is output from the SPEAKERS A 1 jack. The final level of this signal is adjusted by the master MONO OUT fader.

Set the switch to this position when you connect only one speaker to play a loud sound.

### 36 Maximum output select switch

This switch lets you change the maximum output level of the two internal power amps between three levels.

Set this as appropriate for the size of the room or the input capacity of the speakers.

- **500W + 500W**

The two internal amps will produce a maximum of  $500W + 500W/4\Omega$ .

- **300W + 300W**

The two internal amps will produce a maximum of  $300W + 300W/4\Omega$ .

- **100W + 100W**

The two internal amps will produce a maximum of  $100W + 100W/4\Omega$ .



## ■ POWER indicator

### ③7 POWER indicator

This indicator will light up when the power of the EMX5000-20/EMX5000-12 is turned on.



## ■ YAMAHA SPEAKER PROCESSING

### ③8 ON/OFF switch

This switch enables you to compensate the low range of the speakers. The low range balance when this switch is on varies depending on the speakers.

First, check the low range balance by auditioning the resultant sound, then set this switch to on or off.

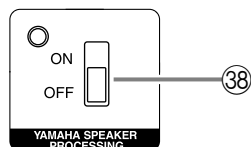

## ■ STAND-BY

### ③9 ON/OFF switch

This switch mutes (silences) the input signals from channels 1–16 (EMX5000-20) or channels 1–8 (EMX5000-12). The indicator will blink when this switch is on.

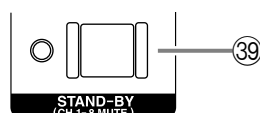

## ■ Other indicators and controls

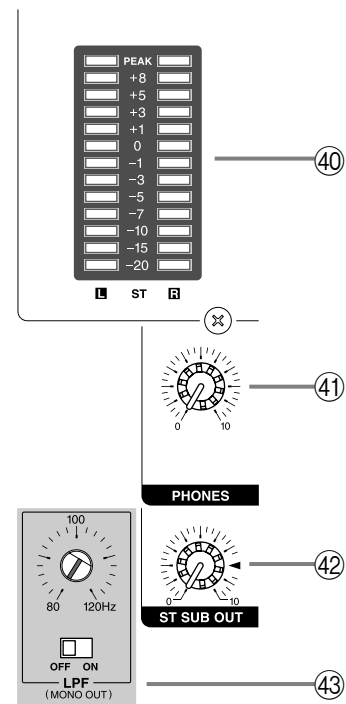

### ④0 Peak level indicator

This indicator allows you to monitor the level of the signal output from the ST OUT jacks. The “0” indicator lights up when the output level reaches +4 dB.

### ④1 PHONES control

This knob adjusts the level of the signal monitored via the PHONES jack (input/output panel ⑭).

### ④2 ST SUB OUT control

This knob adjusts the final level of the signal sent from the STEREO bus to the ST SUB OUT jacks (input/output panel ⑪).

*Note:* The setting of this control does not affect signals that are sent from the STEREO bus to the ST SUB OUT jacks and the SPEAKERS jacks.

### ④3 LPF control, ON/OFF switch

This switch applies a low-pass filter to the signal that is output from the PFL/AFL bus to the MONO OUT jack. The frequency is indicated by the position of the slit in the control trimmer that is set into the panel above the switch. To adjust the frequency, use a slotted screwdriver to turn the control to the desired position. This will output the region below the frequency (80–120 Hz) you specify by the control knob.

Use this when you are using a sub-woofer.

# Input/output panel

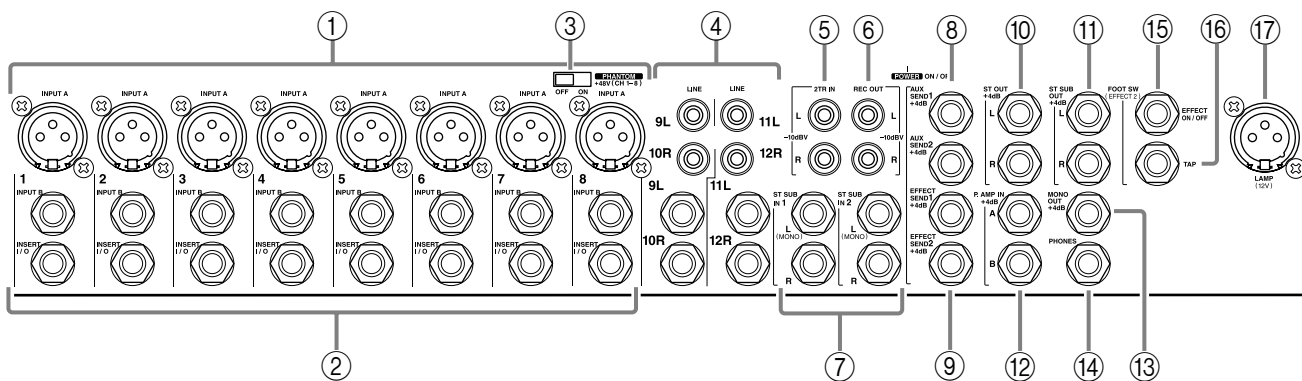

## ① Channel input jacks (INPUT A, INPUT B) EMX5000-20: 1–16, EMX5000-12: 1–8

By using the GAIN control (control panel ②) you can connect any of the jacks to a wide range of sources, from mics to line-level devices (including synthesizers and rhythm machines). The INPUT A jacks can provide +48V phantom power, allowing you to use condenser microphones.

The nominal input level is from -16 dB to -60 dB when the 26 dB pad switch (control panel ①) is off, or from +10 dB to -34 dB when it is on.

Both INPUT A and B are balanced.

They are compatible with microphones of output impedance 50–600Ω or line level devices of 600Ω.

Pin connections for the jacks are as follows:

INPUT A jacks (XLR type)	INPUT B jacks (TRS phone jacks) *
Pin 1: ground	Sleeve: ground
Pin 2: hot (+)	Tip: hot (+)
Pin 3: cold (-)	RInG: cold (-)

\* You can also connect a normal unbalanced phone plug.

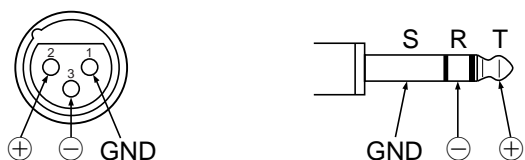

*Note:* It is not possible to simultaneously use both the INPUT A and B inputs of a given channel. For each channel, use only one of the inputs as appropriate for the input source. Phantom power is switched on/off simultaneously for channels 1–8 and 9–16 (EMX5000-20), 1–8 (EMX5000-12). For this reason, devices (in particular, unbalanced devices) other than condenser microphones must be connected to the INPUT B input jacks of channels or channel 17/18–19/20 (EMX5000-20), 9/10–11/12 (EMX5000-12) input jacks if the PHANTOM +48V switch (control panel ③) is on.

## ② INSERT I/O (insert) jacks

These are TRS phone jacks that enable you to insert an external effect processor, such as a compressor/limiter, between the equalizer and fader of input channels. These connections require a special “Y” cable, such as shown in the following diagram. The nominal input/output levels are 0 dB.

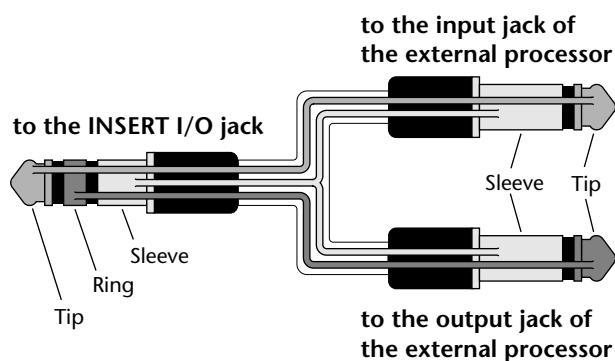

### ③ PHANTOM switch

This is an on/off switch for the phantom power supplied to the INPUT A jacks of channels 1–8 and 9–16 (on the EMX5000-20) or channels 1–8 (on the EMX5000-12). When this switch is on, the indicator in the upper part of the control panel will light.

### ④ LINE (stereo) input jacks EMX5000-20: 17/18–19/20, EMX5000-12: 9/10–11/12

These are the input jacks for channels 17/18–19/20, 9/10–11/12 and are used to connect to the stereo output jacks of electronic instruments, cassette decks, or CD players.

You can connect either phone plugs or RCA phono plugs, as appropriate for the type of jack on the device you are connecting. The nominal input level is from –34 dB to +10 dB.

### ⑤ 2TR IN jacks

These are phono jacks that allow the signal from an external device, such as a cassette deck and CD player, to be added to the STEREO bus. The nominal input level is –10 dBV.

### ⑥ REC OUT jacks

These phono jacks are used to connect to the inputs of a recording device, such as a cassette deck, to record the signal from the STEREO bus. The nominal output level is –10 dBV.

*Note:* The setting of the graphic equalizer or ST OUT fader on the control panel does not affect the signals output from these jacks. Adjust the recording level on the recording device.

### ⑦ ST SUB IN 1 (stereo sub 1) jacks ST SUB IN 2 (stereo sub 2) jacks

These phone jacks are used to connect stereo outputs of a sub mixer or external effect processor. The signal input here can be routed to the AUX 1 bus, AUX 2 bus, and STEREO bus. The nominal input level is +4 dB.

*Note:* Use only the L jack to connect a monaural output device.

### ⑧ AUX SEND 1 jack, AUX SEND 2 jack

These phone jacks output the line-level signals of the AUX 1/2 buses. Connect stage-monitoring amplifiers or powered speakers here. Use the AUX 1 fader (control panel ⑱) and the AUX 2 fader (control panel ⑲) respectively to adjust the final level of the signals output from these jacks. The nominal output level is +4 dB.

### ⑨ EFFECT SEND 1 jack, EFFECT SEND 2 jack

The input of an external effect unit such as a delay or echo can be connected to this jack.

The signal adjusted by the EFF 1, 2 control of each channel will be sent to the EFFECT 1, 2 bus, and output from this jack.

The nominal output level is +4 dB.

### ⑩ ST OUT jacks

These phone jacks output the line level signal of the STEREO bus. The final output level from these jacks is adjusted by the ST OUT fader (control panel ⑳). The nominal output level is +4 dB.

### ⑪ ST SUB OUT jacks

These phone jacks output the line-level signals of the STEREO bus. Connect an external mixer or additional PA system to these jacks.

Use the ST SUB OUT control (control panel ㉑) to adjust the final output level at the ST SUB OUT jacks.

The nominal output level is +4 dB.

### ⑫ P.AMP IN A, B (power amp input) jacks

These phone jacks are used to input line-level stereo signals to the two-channel built-in power amplifier. Connect an external mixer output here. The nominal input level is +4 dB.

*Note:* If you insert a plug into this jack, the corresponding channel of the power amplifier will be isolated, and no signals will be sent from the mixer section.

### ⑬ MONO OUT jack

This phone jack mixes the STEREO bus signals and output a monaural signal. Connect an additional PA system here. Use the MONO OUT fader (control panel ㉒) to adjust the final level of the signal output from this jack. The nominal output level is +4 dB.

### ⑭ PHONES jack

This is a stereo phone type output jack, and is used to monitor the channels selected by the PFL switches on the front panel and the buses selected by the AFL switches.

The nominal output is 3mW when headphones are connected.

### ⑮ FOOT SW EFFECT 2 ON/OFF jack

A separately sold Yamaha FC5 foot switch can be connected to this jack so you can use your foot to switch the built-in digital EFFECT 2 on/off.

⑩ **FOOT SW (EFFECT 2) TAP jack**

When ⑩ TAP DELAY is selected as the internal effect type for the EFFECT 2 RTN channel, you can connect a separately sold FC5 foot switch to this jack, and press the foot switch to set the delay time to the corresponding interval. When you press the foot switch several times, the delay time will be set to the interval between the last two presses.

⑪ **LAMP jack**

This is an XLR (3-pin female) output jack that supplies power to a lamp.

## Rear panel

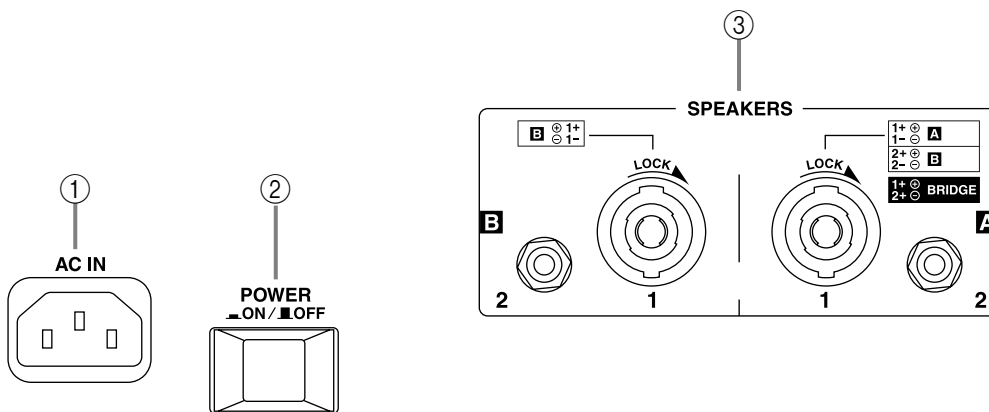

① **AC inlet**

Connect the socket end of the included AC cable to this inlet. Connect the plug end of the cable to an AC outlet of the voltage printed below the inlet.

② **POWER switch**

This switch turns on/off the power to the EMX5000-20/EMX5000-12.

*Note:* Before you turn the power of the EMX5000-20/EMX5000-12 on or off, the faders and controls in the master section of the control panel must be lowered to the minimum position.

③ **SPEAKERS (speaker output) jacks**

These jacks are used to connect speakers.

Jacks 1 are Speakon-type connectors. Jacks 2 are 1/4" phone jacks. The setting of the control panel power amp select switch ⑮ will determine the signal that is output to these jacks, and the number and appropriate impedance of the speakers that can be connected.

# Installation/Connections

## Installation

The EMX5000-20/EMX5000-12 uses a forced cooling system with air intake on the right side and exhaust on the rear. When placing the unit, make sure that the cooling ports are not obstructed.

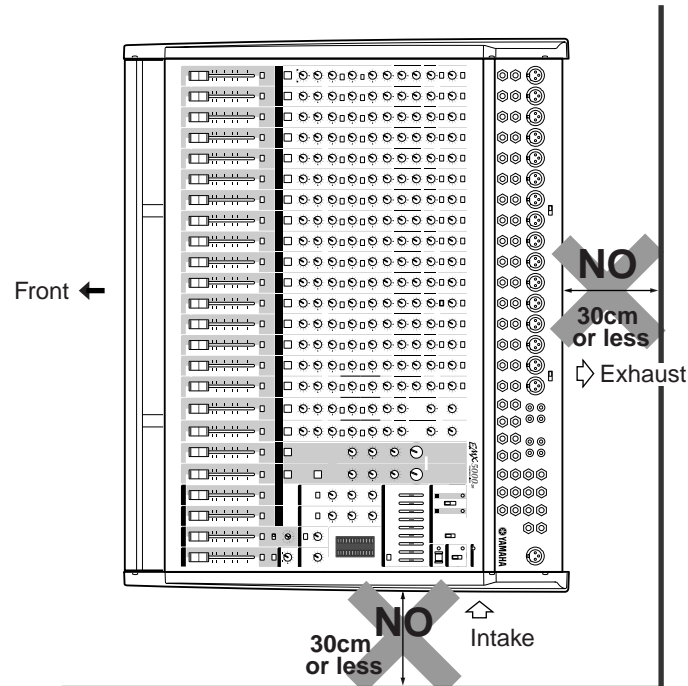

## Connection

When connecting various devices, make sure the cables and plugs have the correct rating. Be sure to use cables designed for the purpose when you connect speakers to speaker jacks.

### ■ Connecting main speakers

There are three ways in which speakers can be connected to the EMX5000-20/EMX5000-12.

The speaker impedance requirement varies depending on how you connect the speakers. Refer to the diagrams below to make sure the speaker impedance will not be lower than the specified value.

#### ■ When the power amp select switch is set to ST L-R, AUX 1-MONO or AUX 1-AUX 2:

Select either one or two speakers each to jacks A and jacks B. Make connections to either jacks 1 or 2, depending on the type of speaker cable you are using.

When the power amp select switch is in the ST L-R position, the signals of the stereo L and R bus will be output from the speakers connected to jacks A and B respectively.

When this switch is in the AUX 1-MONO position, the signals of the AUX 1 bus and the STEREO bus will be combined and output as a monaural signal from the speakers connected to these jacks.

When this switch is in the AUX 1-AUX 2 position, the signals of the AUX 1 bus and AUX 2 bus will be output from the speakers connected to these respective jacks.

#### • Two channel connections

Use speakers with an impedance in the range of 4–8 ohms if you are connecting only one speaker to each set of outputs. A maximum output of 500W + 500W will be obtained when 4-ohm speakers are used.

• **Two channel parallel connections**

If you connect two speakers in parallel to the SPEAKERS A and SPEAKERS B jacks, use speakers with an impedance in the range of 8–16 ohms. A maximum output of 500W + 500W will be obtained when 8-ohm speakers are used.

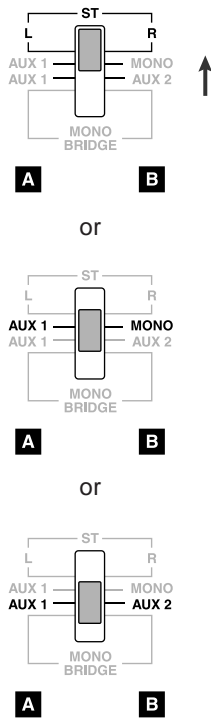

**Two-channel connection**

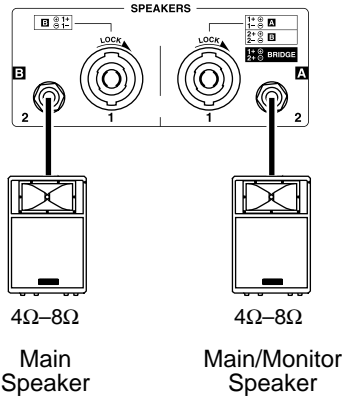

\* Use either the 1 (Speaker) jacks or 2 (phone) jacks of **A** and **B**.

**Two-channel parallel connection**

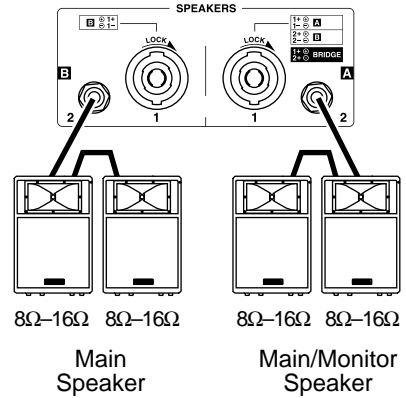

\* Use either the 1 (Speaker) jacks or 2 (phone) jacks of **A** and **B**.

■ **When the power amp select switch is set to MONO BRIDGE:**

• **Bridge connection**

Connect only one 8–16 ohm speaker to the A1 jack. The speaker will output the combined monaural signal of the STEREO bus. A maximum output of 1000 W will be obtained when an 8-ohm speaker is used.

If you are inputting a signal from the P.AMP IN jack, input it to P.AMP IN jack A.

**Caution:**  
When using a bridge connection, do not connect a speaker to the B or A 2 jack.

**Bridge connection**

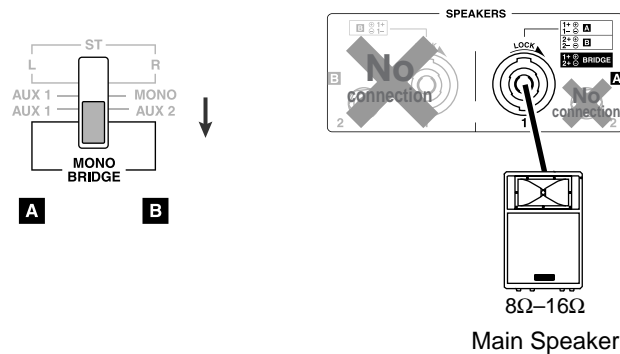

\* Use the 1+(+) and 2+(-) pins of the **A** 1 jack.

# Connecting input/output equipment

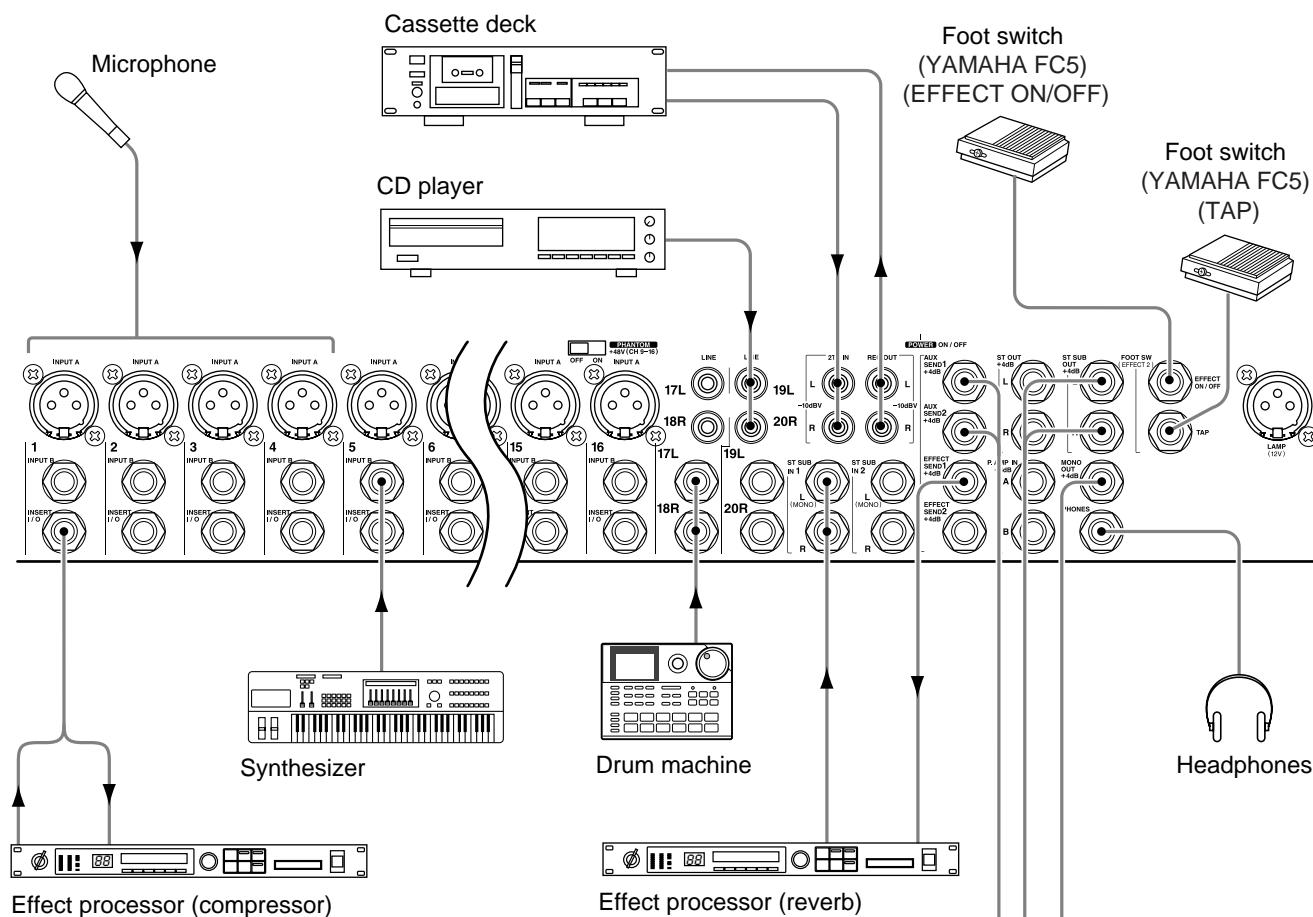

Normally, connect speakers to the jacks on the rear panel.  
If more speaker outputs are needed, use the ST SUB OUT jacks and the MONO OUT jack.

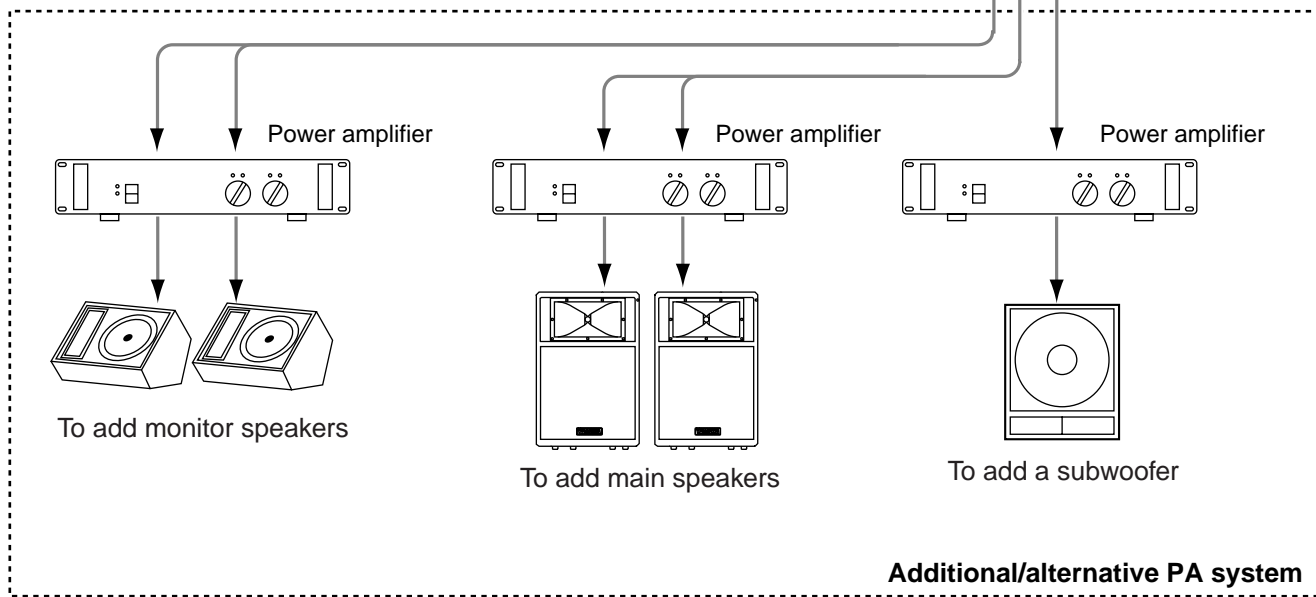

# Basic operation

## Connecting microphones and instruments

① Before connecting mics or instruments, make sure that the power of all equipment (where applicable) is turned off. Also make sure that each channel fader and the faders in the master section are turned down. Check to see if the Power amp select switch on the control panel is set to ST L-R.

② Connect cables to your mics and instrument, and insert the other end of the cables firmly into the appropriate INPUT A/B jacks (EMX5000-20: channels 1–16, EMX5000-12: channels 1–8) or the 17L/18R, 19L/20R (EMX5000-20), 9L/10R, 11L/12R (EMX5000-12) jacks.

*Note:* You cannot use channel 1–16 (EMX5000-20), 1–8 (EMX5000-12) INPUT A and B jacks at the same time.

③ Turn on the power to the peripheral devices, then turn on the power to the EMX5000-20/EMX5000-12.

*Note:* When turning the power off, reverse this sequence.

④ While speaking into the mic (or while playing the instrument), adjust the channel GAIN control so that the channel PEAK indicator lights occasionally at the maximum volume.

⑤ Raise the ST OUT fader in the master section to the “10” position, and while speaking into the mic (or while playing the instrument), adjust the channel fader so that the 0 LED of the peak level indicator lights occasionally. Use the LEVEL control to adjust the maximum level of the speakers.

⑥ If you wish to adjust the tone of each channel, rotate the equalizer controls as desired.

⑦ Use the graphic equalizer and the ST fader in the master section to adjust the overall volume and tone.

*Note:* The volume level is affected by the settings of the channel equalizers and the graphic equalizer. When you set the equalizers, check the peak level indicator and adjust the ST fader if necessary.

## Using the digital effect

The EMX5000-20/EMX5000-12 has a built-in digital effect, allowing reverberation or ambiance to be added to vocals or instrumental sounds.

① Connect a mic or instrument to the desired channels, and adjust the volume and tone.

② Press the ON switch of the digital effect section.

③ Use the PROGRAM selector to select the type of effect you wish to apply.

④ Raise the EFF 1 (or EFF 2) control of the channels to which you wish to apply the digital effect.

⑤ Use the EFFECT 1 (or EFFECT 2) RTN fader of the digital effect section to adjust the level of the effect sound.

*Note:* You can send the effect sound to the AUX 1/2 bus by raising the AUX 1/2 control in the digital effect section. If the effect sound is distorted even though the ST control and the AUX 1/2 controls in the digital effect section are turned all the way down, lower the EFF 1 (or EFF 2) controls of the digital effect section.

⑥ Adjust the PARAMETER control of the digital effect section to the desired level.

*Note:* The setting of the AUX 1/2 fader in the master section does not affect the internal effect.



## Digital effect program list

### Common to EFFECT 1 and 2

No.	Program	Description	Controllable parameter	
			Parameter	Variable range
<b>1</b>	REVERB HALL	Reverberation simulating a spacious expanse such as a concert hall.	Reverb time	0.3–10.0s
<b>2</b>	REVERB ROOM	Reverberation simulating the acoustics of a small room.	Reverb time	0.3–3.2s
<b>3</b>	REVERB PLATE	Simulation of a plate reverb device. Produces a hard-sounding reverberation.	Reverb time	0.3–10.0s
<b>4</b> <b>5</b>	REVERB VOCAL 1 REVERB VOCAL 2	Ideal reverb for vocals.	Reverb time	0.3–10.0s
<b>6</b> <b>7</b>	VOCAL ECHO 1 VOCAL ECHO 2	Ideal echo for vocals.	Delay time	0–800ms
<b>8</b> <b>9</b>	DELAY 1 DELAY 2	Delay effect that delays the signal.	Delay time	0–800ms

### EFFECT 1

<b>10</b>	MOD. DELAY	Monaural delay with modulation	Delay time	0–800ms
<b>11</b>	REVERB GATE	An effect that simulates reversed early reflections.	Room size	0.1–10.0
<b>12</b>	PITCH CHANGE	An effect that changes the pitch of the input signal.	Pitch	–12+12
<b>13</b>	CHORUS	Modulates the delay time of the signal to add depth to the sound.	Depth	0–100%
<b>14</b>	PHASER	An effect that changes the phase of the sound to create modulation.	Modulation frequency	0.05–4.00Hz
<b>15</b>	RADIO VOICE	An effect that produces a lo-fi sound like that of an AM radio.	Drive	0–100
<b>16</b>	TREMOLO	An effect that adds modulation to the sound.	Modulation frequency	0.05–10.00Hz

### EFFECT 2

<b>10</b>	EARLY REF.	An effect produced by modifying the early reflections. It lets you add depth to the sound, or create echo-like effects.	Room size	0.1–10.0
<b>11</b>	GATE REVERB	An effect produced by cutting the reverberation.	Room size	0.1–5.0
<b>12</b>	VOCAL DOUBLER	Produces an effect as though two people were singing.	Pitch fine	0–50
<b>13</b>	SYMPHONIC	Gives a richly layered depth to the sound.	Depth	0–100%
<b>14</b>	FLANGE	Adds a sense of pitch to the tone. Effective on sounds that contain numerous overtones.	Modulation frequency	0.05–4.00Hz
<b>15</b>	DISTORTION	The well-known effect used to distort the sound.	Drive	0–100
<b>16</b>	TAP DELAY	This effect sets the delay time to the interval at which you actually press the switch. The amount of feedback can be adjusted by the PARAMETER control. The LED will blink in synchronization with the delay time.	Feedback gain	0–99%
			Delay time	100ms (600bpm)–2690ms (22.3bpm)*

\* The LED can not blink any faster than an interval of 256 ms (234.3 bpm).

# Example setups

This section provides some ways in which the EMX5000-20/EMX5000-12 can be used, and explains connections and operation.

## As a conference/entertainment hall sound system

Here is an example of using the EMX5000-20/EMX5000-12 as a conference or entertainment hall sound system.

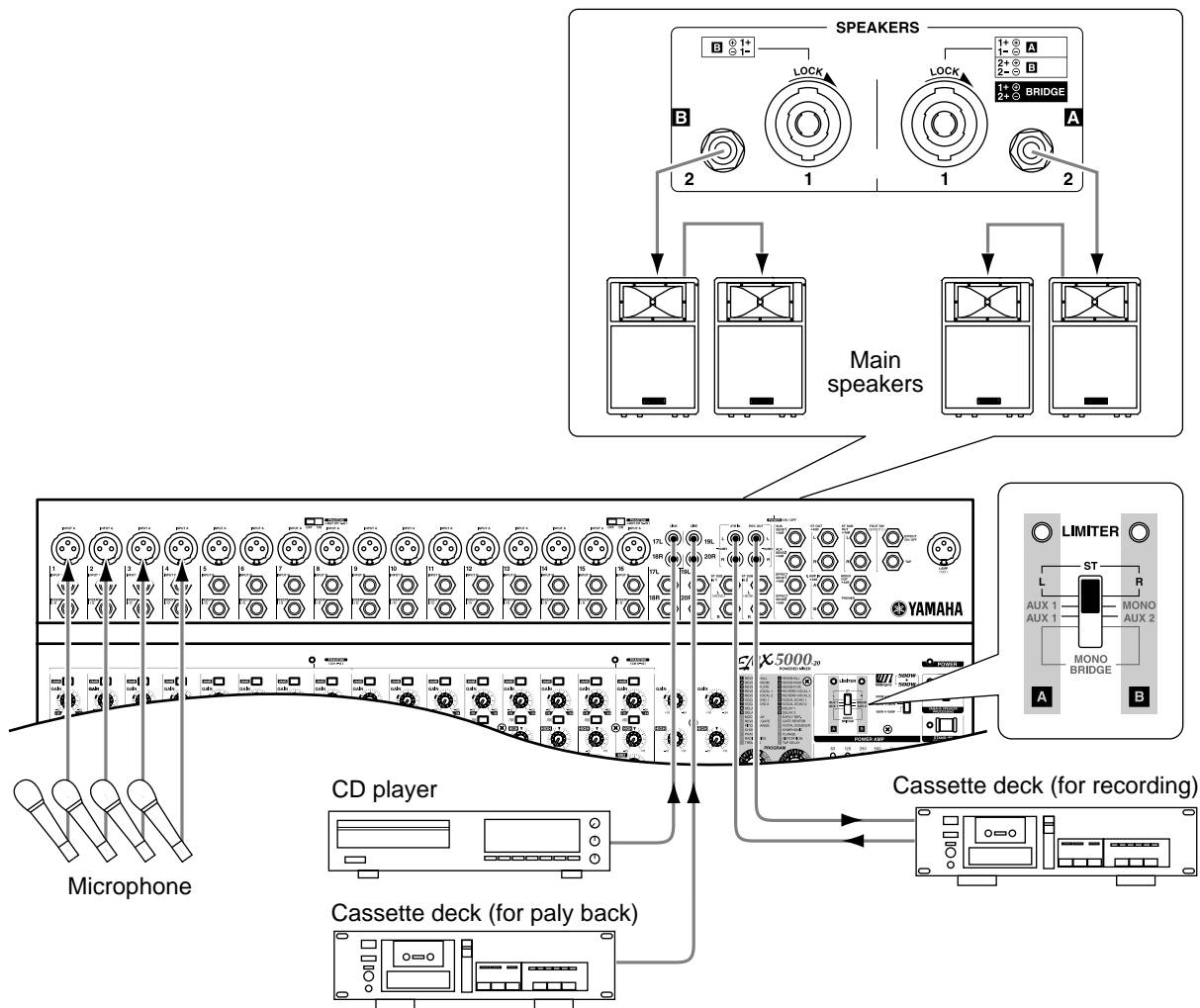

## ■ Connections

- Connect mics to channel inputs 1–8.
- A CD player/cassette deck can also be connected to the input jacks of channels 17/18 and 19/20 (EMX5000-20), 9/10 and 11/12 (EMX5000-12).
- To record a meeting or a party, connect the REC OUT jacks of the EMX5000-20/EMX5000-12 to the input jack of a recording cassette deck, and to monitor the recording on the EMX5000-20/EMX5000-12, connect the 2TR IN jacks of the EMX5000-20/EMX5000-12 to the output of the recording cassette deck.
- Connect the main speakers to the SPEAKERS A and B jacks, and set the Power amp select switch to ST L-R.

## ■ Playing back a CD player

- ① Turn on the power to the peripheral devices, then to the EMX5000-20/EMX5000-12.
- ② Start playback on the CD player. Use the GAIN control of channel 17/18 (EMX5000-20), 9/10 (EMX5000-12) so that the PEAK indicator below the GAIN control will light occasionally. Then, raise the ST OUT fader to the “0” position, and adjust the channel 17/18 (EMX5000-20), 9/10 (EMX5000-12) fader so that the 0 LED of the peak indicator will light occasionally.
- ③ As appropriate for the size of the room, use the maximum output select switch to adjust the volume (maximum output).

## As a band PA

Here is an example of using the EMX5000-20/EMX5000-12 as a small PA for a band. In this example, the monitor speakers are being sent a mix that is independent of the MAIN speaker mix. An external effect such as delay or reverb is also being used.

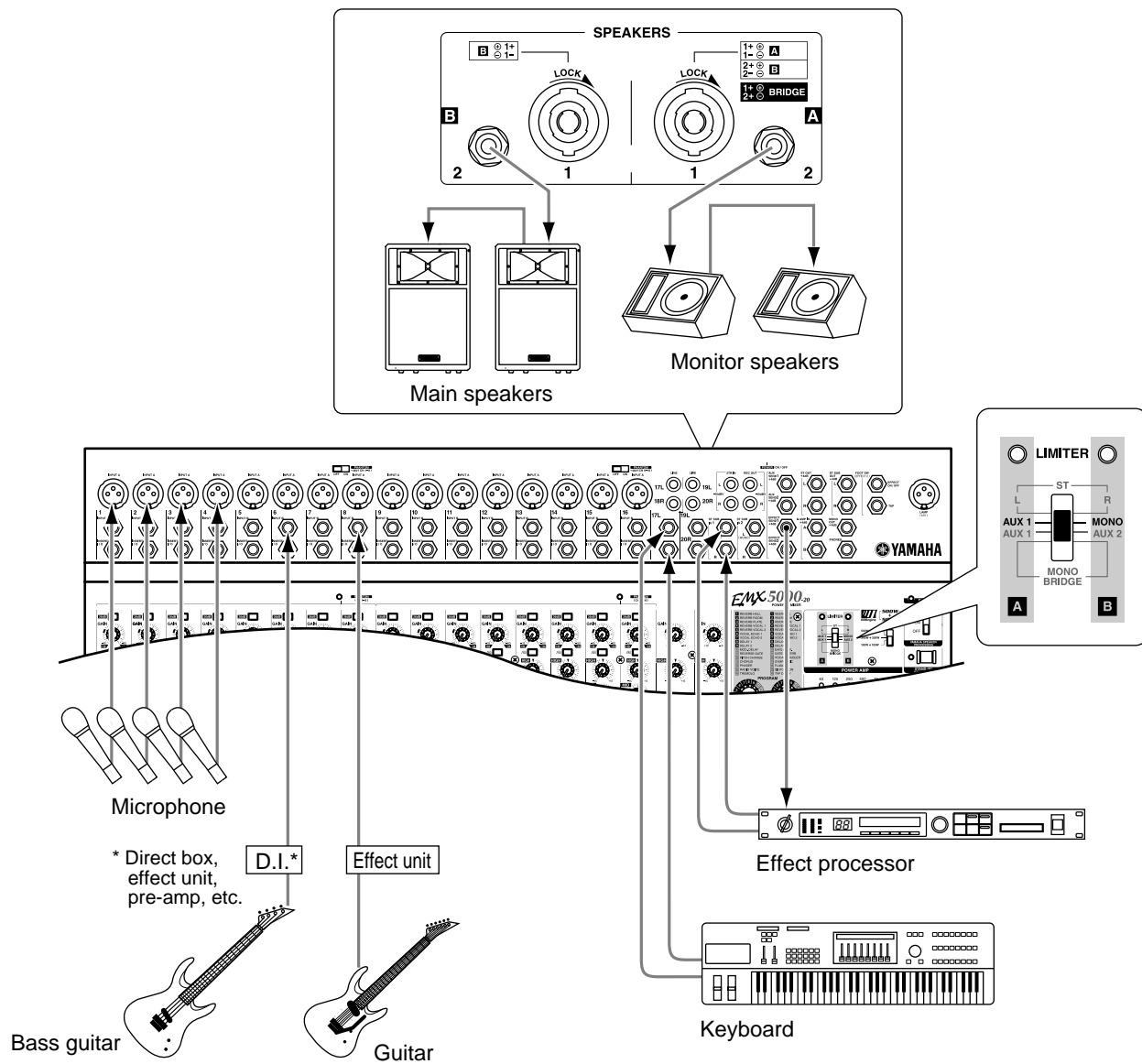

## ■ Connections

- Connect mics or instruments, such as keyboards, to channel input jacks 1–20 (EMX5000-20), 1–12 (EMX5000-12).
- Connect the main speakers to the SPEAKERSB 1/2 jacks, and connect the monitor speakers to the SPEAKERS A 1/2 jacks. Set the Power amp select switch to “AUX 1-MONO.”
- If you use an external effect such as delay or reverb, connect the EMX5000-20/EMX5000-12’s EFFECT SEND jack to the input jack of the external effect, and connect the output jack of the external effect to the EMX5000-20/EMX5000-12’s ST SUB IN 1.

*Note:* If you are using an external effect, we recommend that you turn down all the EFFECT controls of the digital effect section. You can connect the output of an external effect to channels 17/18 and 19/20 (EMX5000-20), 9/10 and 11/12 (EMX5000-12) to apply the equalizer to the effect return signal. However in this case, make sure that the EFF 1 (or EFF 2) controls are turned all the way down for the channels into which the effect sound is being input. If the EFF 1 (or EFF 2) controls are raised, feedback will occur, and your speakers may be damaged.

## ■ Sending an independent mix to the monitor speakers

- ① Set the AUX 1 fader to the “0” position.
- ② Raise the AUX 1 controls for the channels that you wish to hear from the monitor speakers. Turn the AUX 1 POST switch off, in the unpressed (pre-fader) position.

*Note:* The AUX controls are not affected by the level settings of each channel. This allows you to create a mix that is independent of the main speakers.

- ③ Use the AUX 1 OUT fader of the master section to adjust the overall volume.

## ■ Using an external effect processor

You may sometimes want to use an external effect processor.

Follow the steps below.

- ① **Raise the EFF 1 (or EFF 2) controls for the channels to which you want the external effect to be applied.**
- ② **Adjust the level of the signal output to the external effects processor so that the sound will not be distorted at the input of the external effects processor.**
- ③ **Use the control of the ST SUB IN channel to which the processed signal is input from the external effects processor to adjust the level of the effect sound.**

## Using a subwoofer

Here is an example of using a subwoofer in the speaker system.

If you are using a sub-woofer, press the LPF ON/OFF switch (located in the lower right of the EMX5000-20/EMX5000-12) to send the low-range signal to the sub-woofer. The frequency range below the frequency specified by the control knob (80–120 Hz) will be output to the sub-woofer.

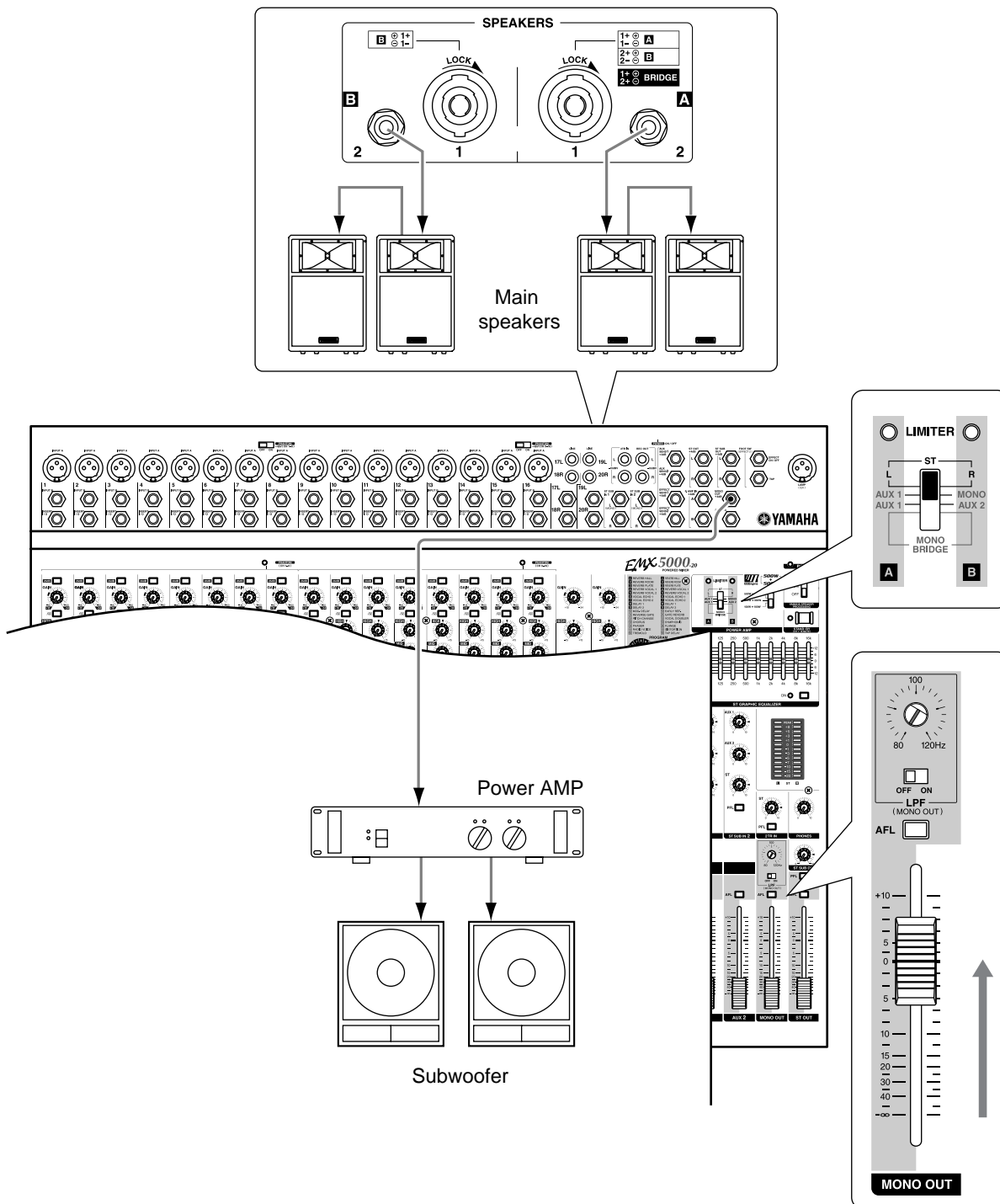

# Troubleshooting

The following table describes the possible malfunctions of this device, and the appropriate actions to be taken in each case.

Problem		Cause	Action
Sound is no longer output from the speakers.	The POWER indicator is dark.	The load on this device was too great, and the protection circuit for the power unit has operated. Possible reasons for the excessive load are an excessive input to the device, or inappropriate ventilation.	Please wait. When the device cools off, normal operation will resume automatically. However, please check the following two points to prevent the problem from recurring. If the input to this device is greater than the nominal level, lower the input to the nominal level. If the device is not ventilated sufficiently, refer to the cautions given at the beginning of this manual and take appropriate measures to insure adequate ventilation.
	The POWER indicator is lit.	The load on the amplifier of this device was too great, and the protection circuit for the amplifier has operated. Possible reasons for the excessive load are an excessive level setting in the channel control section or main section, insufficient ventilation, or insufficient load impedance of the connected speakers.	Please wait. When the device cools off, normal operation will resume automatically. However, please check the following three points to prevent the problem from recurring. If the level setting is excessive, lower it to the nominal level. You can refer to the peak level indicators of the main section when doing so. If the device is not ventilated sufficiently, refer to the cautions given at the beginning of this manual and take appropriate measures to insure adequate ventilation. If the load impedance (including a short) is too low, refer to the chapter on connections (page 19–20) and change the connections so that the impedance is correct.
	Other	Connections between devices have come loose.	
Other			The device may have malfunctioned. Please contact your dealer.

## Powered Mixer Q&A

<b>Q:</b> The built-in effect is not effective.	<b>A:</b> The ON switch in the DIGITAL EFFECT section may not be turned on. Or, you have adjusted the EFFECT control in the Channel section or the EFFECT RTN fader in the DIGITAL EFFECT section.
<b>Q:</b> The monitoring sound from the speakers is not powerful enough relative to the level of the input sound.	<b>A:</b> The equalizer LOW control for each channel may be set to negative values.
<b>Q:</b> The signal is sent from the EFFECT SEND jack to the connected effect processor. Then the effect sound is returned to the ST SUB IN jack. However, no signal is input to the mixer.	<b>A:</b> The ST or AUX control in the STEREO SUB INPUT section may not be rotated to right.
<b>Q:</b> An external powered speaker is connected to the AUX SEND jack. However, the signal is not sent to the speaker even when the AUX fader in the MASTER CONTROL section is raised.	<b>A:</b> The AUX controls for input channels may not have been adjusted.
<b>Q:</b> Can the INPUT A jack and the INPUT B jack be used at the same time?	<b>A:</b> You cannot use the INPUT A jack and the INPUT B jack for the same channel at the same time.
<b>Q:</b> Can a single speaker be connected to the mixer?	<b>A:</b> Yes. Use a speaker with an impedance of 4-8 ohms.

# Specifications

## ■ General specifications

Maximum output power	SPEAKERS: 500 W+500 W/4Ω @0.5% THD at 1 kHz 325 W+325 W/8Ω @0.5% THD at 1 kHz BRIDGE: 1000 W/8Ω @0.5% THD at 1 kHz	
Frequency response	20 Hz–20 kHz +1 dB, –3 dB @1 W output into 8Ω (SPEAKERS OUT)	
	20 Hz–20 kHz +1 dB, –3 dB @+4 dB output into 600Ω (ST OUT, ST SUB OUT, MONO OUT, AUX SEND, EFFECT SEND)	
Total harmonic distortion	Less than 0.5% @20 Hz–20 kHz, 250 W output into 4Ω (SPEAKERS OUT) Less than 0.3% @20 Hz–20 kHz, +14 dB output into 600Ω (ST OUT, ST SUB OUT, MONO OUT, AUX SEND, EFFECT SEND)	
Hum & noise (Average, $R_s=150\Omega$ ) (with 20 Hz–20 kHz BPF)	–128 dB equivalent input noise, –65 dB residual output noise (SPEAKERS OUT)	
	–95 dB residual output noise (ST OUT, ST SUB OUT, AUX SEND)	
	–84 dB (ST OUT, MONO OUT)	ST master/MONO master fader at nominal level and all channel On switches off and all channel fader at minimum.
	–64 dB (68 dB S/N) (ST OUT, MONO OUT)	ST master fader at nominal level and one channel On switch on and one channel fader at nominal level and one channel Gain control at nominal level.
	–81 dB (AUX SEND)	Master fader at nominal level and all channel On switches off and all channel level control at minimum.
	–80 dB (EFFECT SEND)	All channel level control at minimum.
Maximum voltage gain	108 dB INPUT A/B to SPEAKERS OUT 84 dB INPUT A/B to ST OUT, MONO OUT 80 dB INPUT A/B to AUX SEND (PRE) 90 dB INPUT A/B to AUX SEND (POST) 78 dB INPUT A/B to EFFECT SEND 58 dB ST CH IN to ST OUT	
Crosstalk at 1 kHz	68 dB adjacent input, 68 dB input to output	
Input channel equalization	±15 dB Maximum HIGH 10 kHz shelving* MID 250 Hz–5 kHz peaking LOW 100 Hz shelving* * Turn over/roll off frequency of shelving: 3 dB below maximum variable level.	
ST Input channel equalization	±15 dB Maximum HIGH 10 kHz shelving* MID 2.5 kHz peaking LOW 100 Hz shelving* * Turn over/roll off frequency of shelving: 3 dB below maximum variable level.	
CH peak indicators	Red LED on each channel lits when POST EQ signal reaches the level –3 dB below clipping.	
CH signal indicators	Green LED on each channel lits when POST EQ signal reaches the level –10 dB.	
Meters	13 points LED meter	
Power amp select switch	500W + 500W, 300W + 300W, 100W + 100W	
Limiter	Comp. : THD≥0.5% (SPEAKERS OUT)	
LIMIT indicators	Turn on : THD≥0.5% (SPEAKERS OUT)	
Graphic equalizer	9 bands (63, 125, 250, 500, 1k, 2k, 4k, 8k, 16k Hz), ±12 dB Maximum	
Internal digital effect 1	16 programs, parameter control	
Internal digital effect 2	16 programs, parameter control, tap delay control, foot switch (DIGITAL EFFECT ON/OFF, TAP)	
Foot switch (FC5)	Digital effect 2 mute: on/off, Tap delay	
Protection circuit (Power amp)	POWER switch on/off mute, DC detection, TEMP (heatsink temp. ≥90°C)	
Fan circuit	stop — low speed (50°C) — variable — high speed (70°C)	
Phantom power	+48 V (balanced input)	
Option	FC5 (Foot switch), RK-124 (EMX5000-12)	
Power requirement/ Power consumption	USA and Canada: 120 V AC 60 Hz, 400 W Europe: 230 V AC 50 Hz, 550 W Other: 240 V AC 50 Hz, 550 W	



Dimensions (WxHxD)	682 × 158 × 538 mm (EMX5000-20) / 478 × 158 × 538 mm (EMX5000-12)
Weight	19 kg (EMX5000-20) / 15 kg (EMX5000-12)
Accessories	Power cord, Owner's Manual

## Input specifications

Input terminals	Gain control	Actual load impedance	For use with nominal	Input level			Connectors on mixer
				Sensitivity <sup>1</sup>	Nominal	Max. before clip	
CH INPUT A (CH1–8/1–16)	–60	5 kΩ	50–600Ω Mics	–80 dB (0.078 mV)	–60 dB (0.775 mV)	–40 dB (7.75 mV)	XLR-3-31 type <sup>2</sup>
	–16			–36 dB (12.3 mV)	–16 dB (123 mV)	+4 dB (1.23 V)	
CH INPUT B (CH1–8/1–16)	–60	50 kΩ	600Ω Lines	–80 dB (0.078 mV)	–60 dB (0.775 mV)	–40 dB (7.75 mV)	PHONE JACK (TRS) <sup>2</sup>
	–16			–36 dB (12.3 mV)	–16 dB (123 mV)	+4 dB (1.23 V)	
ST INPUT (CH9–12/17–20)	–34	10 kΩ		–54 dB (1.55 mV)	–34 dB (15.5 mV)	–14 dB (155 mV)	PHONE JACK <sup>3</sup>
	+10			–10 dB (245 mV)	+10 dB (2.45 V)	+30 dB (24.5 V)	
ST SUB IN (1, 2)				–12 dB (195 mV)	+4 dB (1.23 V)	+20 dB (7.75 V)	PHONE JACK <sup>3</sup>
2TR IN (L, R)				–26 dBV (50.1 mV)	–10 dBV (316 mV)	+10 dBV (3.16 V)	
INSERT IN (CH1–8/1–16)				–20 dB (77.5 mV)	0 dB (0.775 V)	+20 dB (7.75 V)	PHONE JACK <sup>3</sup>
POWER AMP IN (A, B)				–12 dB (195 mV)	+4 dBV (1.23 V)	+18 dB (6.16 V)	PHONE JACK <sup>3</sup>

- Sensitivity is the lowest level that can produce an output of +4 dB (1.23 V) or the nominal output level when the unit is set at maximum gain. (All fader and level controls are at maximum position.)
  - Balanced. (T=HOT, R=COLD, S=GND)
  - Unbalanced.
- In these specifications when dB represents a specific voltage, 0 dB is referenced to 0.775 Vrms, 0 dBV is referenced to 1 Vrms.

## Output specifications

Output terminals	Actual source impedance	For use with nominal	Output level		Connectors on mixer
			Nominal	Max. before clipping	
ST OUT (L/R)	150Ω	600Ω Lines	+4 dB (1.23 V)	+20 dB (7.75 V)	PHONE JACK <sup>1</sup>
ST SUB OUT (L/R)					
MONO OUT					
AUX SEND 1, 2					
EFFECT SEND 1, 2					
REC OUT (L/R)	600Ω	10 kΩ Lines	–10 dBV (316 mV)	+10 dBV (3.16 V)	PHONO JACK <sup>1</sup>
INSERT OUT (CH1–8/1–16)			0 dB (775 mV)	+20 dB (7.75 V)	PHONE JACK <sup>1</sup>
PHONES (L/R)	100Ω	40Ω Lines	3 mW	75 mW	PHONE JACK (TRS) <sup>2</sup>
SPEAKERS 1 (A, B)	0.1Ω	4/8Ω Speakers	100 W/4Ω	500 W/4Ω	SPEAKON
SPEAKERS 2 (A, B)					PHONE JACK <sup>1</sup>

- Unbalanced.
  - Impedance balanced. (T=HOT, R=COLD, S=GND)
- In these specifications when dB represents a specific voltage, 0 dB is referenced to 0.775 Vrms, 0 dBV is referenced 1 Vrms.

For European Model

Purchaser/User Information specified in EN55103-1 and EN55103-2.

Inrush Current: 70A

Conformed Environment: E1, E2, E3 and E4

## Dimensions

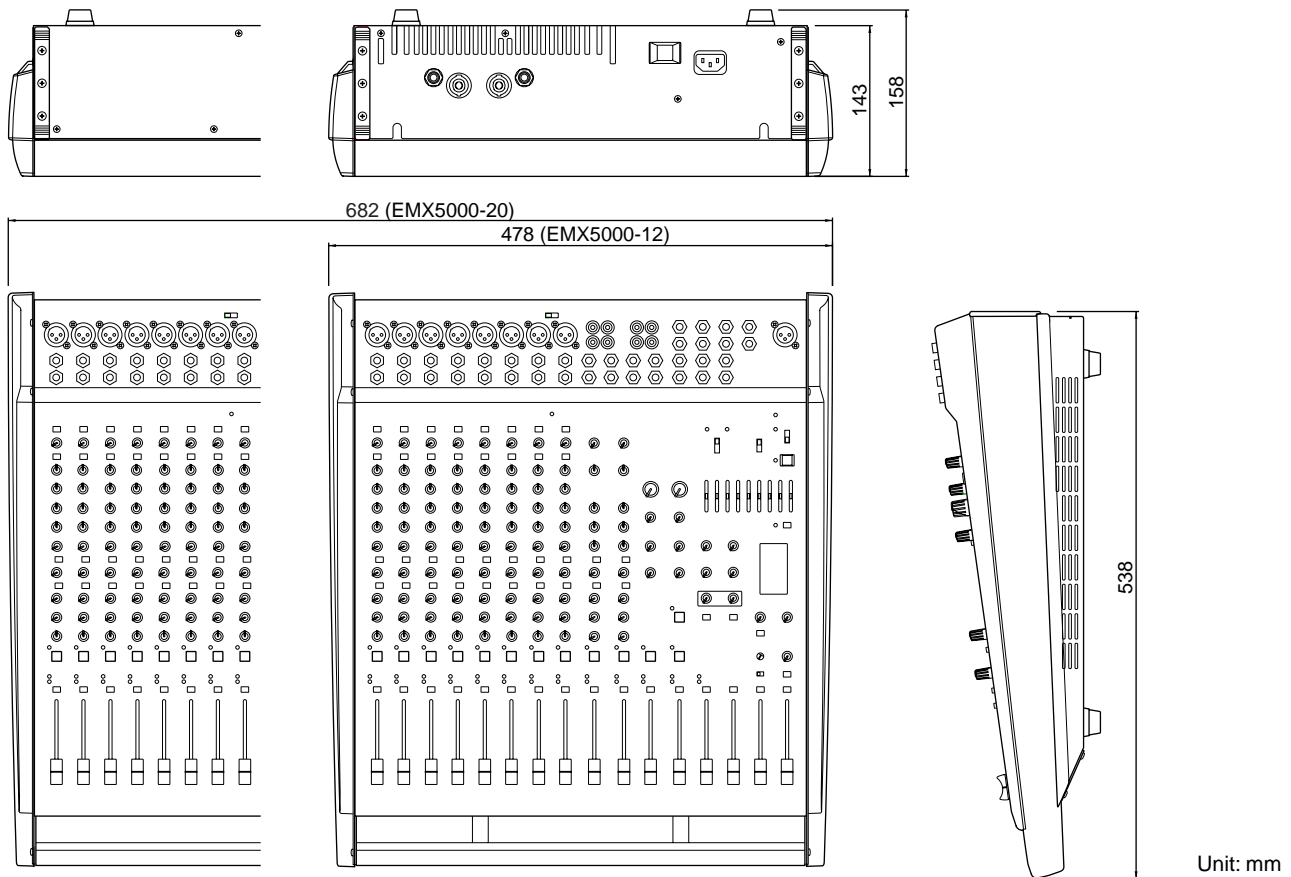

Specifications are subject to change without prior notice.

## ■ Installing an optional rack mount kit

By using the RK124 rack mount kit, you can install the EMX5000-12 in a rack.

Before you rack-mount the EMX5000-20/EMX5000-12, make sure that sufficient ventilation will be maintained. (Never install the unit in a sealed rack.)

If you are going to install multiple devices including the unit in a rack, keep a 1U space or more between the devices. Use a blank panel with holes for ventilation if you wish to insert a panel between the devices.

You will need a 13U space to install the rack mount.

### Attaching the rack mount hardware.

1. Remove the side panel together with the six screws indicated by arrows in diagram ① below.
2. Fasten the rack mount hardware using screws at the locations indicated by arrows in diagram ②-1 or ②-2. The height at which the panel (on which the knobs and faders are located) will be mounted is determined by the set of holes that you use to fasten the rack mount hardware.
3. Attach the rack mount hardware to the other side in the same way.

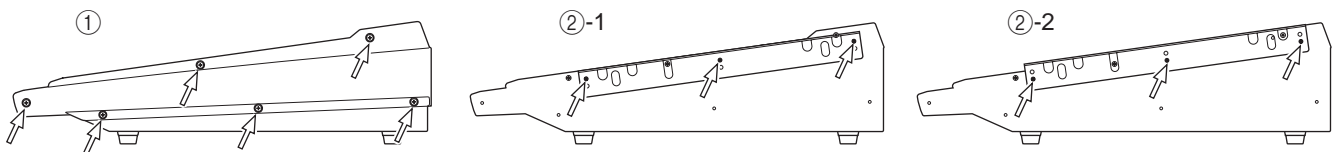

# Block/Level Diagram

