



INPUT EXPANDER
EXi8

OUTPUT EXPANDER
EXo8

Owner's Manual
Bedienungsanleitung
Mode d'emploi
Manual de instrucciones
Manuale di istruzioni
Руководство пользователя
使用说明书
取扱説明書

EN
DE
FR
ES
IT
RU
ZH
JA

English

Deutsch

Français

Español

Italiano

Русский

中文

日本語

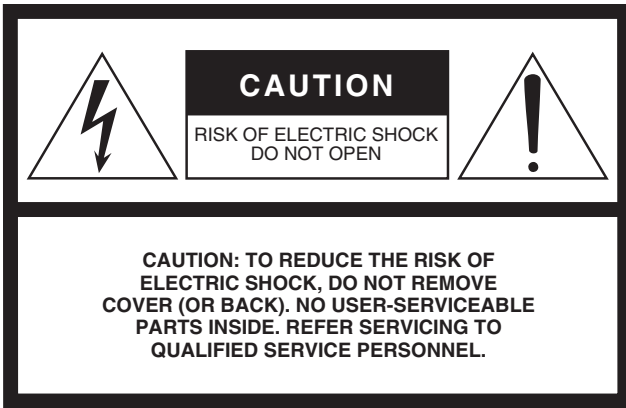

Explanation of Graphical Symbols

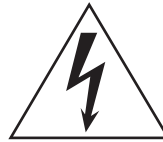

The lightning flash with arrowhead symbol within an equilateral triangle is intended to alert the user to the presence of uninsulated “dangerous voltage” within the product’s enclosure that may be of sufficient magnitude to constitute a risk of electric shock to persons.



The exclamation point within an equilateral triangle is intended to alert the user to the presence of important operating and maintenance (servicing) instructions in the literature accompanying the product.

The above warning is located on the top of the unit.

IMPORTANT SAFETY INSTRUCTIONS

- 1 Read these instructions.
- 2 Keep these instructions.
- 3 Heed all warnings.
- 4 Follow all instructions.
- 5 Do not use this apparatus near water.
- 6 Clean only with dry cloth.
- 7 Do not block any ventilation openings. Install in accordance with the manufacturer’s instructions.
- 8 Do not install near any heat sources such as radiators, heat registers, stoves, or other apparatus (including amplifiers) that produce heat.
- 9 Do not defeat the safety purpose of the polarized or grounding-type plug. A polarized plug has two blades with one wider than the other. A grounding type plug has two blades and a third grounding prong. The wide blade or the third prong are provided for your safety. If the provided plug does not fit into your outlet, consult an electrician for replacement of the obsolete outlet.
- 10 Protect the power cord from being walked on or pinched particularly at plugs, convenience receptacles, and the point where they exit from the apparatus.
- 11 Only use attachments/accessories specified by the manufacturer.
- 12 Use only with the cart, stand, tripod, bracket, or table specified by the manufacturer, or sold with the apparatus. When a cart is used, use caution when moving the cart/apparatus combination to avoid injury from tip-over.
- 13 Unplug this apparatus during lightning storms or when unused for long periods of time.
- 14 Refer all servicing to qualified service personnel. Servicing is required when the apparatus has been damaged in any way, such as power-supply cord or plug is damaged, liquid has been spilled or objects have fallen into the apparatus, the apparatus has been exposed to rain or moisture, does not operate normally, or has been dropped.



WARNING

TO REDUCE THE RISK OF FIRE OR ELECTRIC SHOCK, DO NOT EXPOSE THIS APPARATUS TO RAIN OR MOISTURE.

(UL60065_03)

FCC INFORMATION (U.S.A.)

1. IMPORTANT NOTICE: DO NOT MODIFY THIS UNIT!

This product, when installed as indicated in the instructions contained in this manual, meets FCC requirements. Modifications not expressly approved by Yamaha may void your authority, granted by the FCC, to use the product.

2. IMPORTANT:

When connecting this product to accessories and/or another product use only high quality shielded cables. Cable/s supplied with this product MUST be used. Follow all installation instructions. Failure to follow instructions could void your FCC authorization to use this product in the USA.

3. NOTE:

This product has been tested and found to comply with the requirements listed in FCC Regulations, Part 15 for Class "B" digital devices. Compliance with these requirements provides a reasonable level of assurance that your use of this product in a residential environment will not result in harmful interference with other electronic devices. This equipment generates/uses radio frequencies and, if not installed and used according to the instructions found in the users manual, may cause interference harmful to the operation of other electronic devices. Compliance with FCC regulations does not guarantee that interference will not occur in

all installations. If this product is found to be the source of interference, which can be determined by turning the unit "OFF" and "ON", please try to eliminate the problem by using one of the following measures:

Relocate either this product or the device that is being affected by the interference.

Utilize power outlets that are on different branch (circuit breaker or fuse) circuits or install AC line filter/s.

In the case of radio or TV interference, relocate/reorient the antenna. If the antenna lead-in is 300 ohm ribbon lead, change the lead-in to co-axial type cable.

If these corrective measures do not produce satisfactory results, please contact the local retailer authorized to distribute this type of product. If you can not locate the appropriate retailer, please contact Yamaha Corporation of America, Electronic Service Division, 6600 Orangethorpe Ave, Buena Park, CA90620

The above statements apply ONLY to those products distributed by Yamaha Corporation of America or its subsidiaries.

* This applies only to products distributed by YAMAHA CORPORATION OF AMERICA.

(class B)

IMPORTANT NOTICE FOR THE UNITED KINGDOM

Connecting the Plug and Cord

WARNING: THIS APPARATUS MUST BE EARTHED IMPORTANT. The wires in this mains lead are coloured in accordance with the following code:

GREEN-AND-YELLOW : EARTH
BLUE : NEUTRAL
BROWN : LIVE

As the colours of the wires in the mains lead of this apparatus may not correspond with the coloured markings identifying the terminals in your plug proceed as follows:

The wire which is coloured GREEN-and-YELLOW must be connected to the terminal in the plug which is marked by the letter E or by the safety earth symbol \oplus or colored GREEN or GREEN-and-YELLOW.

The wire which is coloured BLUE must be connected to the terminal which is marked with the letter N or coloured BLACK.

The wire which is coloured BROWN must be connected to the terminal which is marked with the letter L or coloured RED.

(3 wires)

이 기기는 가정용(B급) 전자파적합기기로서 주로 가정에서 사용하는 것을 목적으로 하며, 모든 지역에서 사용할 수 있습니다.

(class b korea)

COMPLIANCE INFORMATION STATEMENT (DECLARATION OF CONFORMITY PROCEDURE)

Responsible Party : Yamaha Corporation of America
Address : 6600 Orangethorpe Ave., Buena Park,
Calif. 90620

Telephone : 714-522-9011

Type of Equipment : I/O Expander

Model Name : EXi8/EXo8

This device complies with Part 15 of the FCC Rules.

Operation is subject to the following two conditions:

- 1) this device may not cause harmful interference, and
- 2) this device must accept any interference received including interference that may cause undesired operation.

See user manual instructions if interference to radio reception is suspected.

* This applies only to products distributed by
YAMAHA CORPORATION OF AMERICA.

(FCC DoC)

PRECAUTIONS

PLEASE READ CAREFULLY BEFORE PROCEEDING

* Please keep this manual in a safe place for future reference.



WARNING

Always follow the basic precautions listed below to avoid the possibility of serious injury or even death from electrical shock, short-circuiting, damages, fire or other hazards. These precautions include, but are not limited to, the following:

Power supply/Power cord

- Do not place the power cord near heat sources such as heaters or radiators, and do not excessively bend or otherwise damage the cord, place heavy objects on it, or place it in a position where anyone could walk on, trip over, or roll anything over it.
- Only use the voltage specified as correct for the device. The required voltage is printed on the name plate of the device.
- Use only the supplied power cord/plug.
If you intend to use the device in an area other than in the one you purchased, the included power cord may not be compatible. Please check with your Yamaha dealer.
- Check the electric plug periodically and remove any dirt or dust which may have accumulated on it.
- Be sure to connect to an appropriate outlet with a protective grounding connection. Improper grounding can result in electrical shock.

Do not open

- This device contains no user-serviceable parts. Do not open the device or attempt to disassemble the internal parts or modify them in any way. If it should appear to be malfunctioning, discontinue use immediately and have it inspected by qualified Yamaha service personnel.

Water warning

- Do not expose the device to rain, use it near water or in damp or wet conditions, or place on it any containers (such as vases, bottles or glasses) containing liquids which might spill into any openings. If any liquid such as water seeps into the device, turn off the power immediately and unplug the power cord from the AC outlet. Then have the device inspected by qualified Yamaha service personnel.
- Never insert or remove an electric plug with wet hands.

Fire warning

- Do not put burning items, such as candles, on the unit. A burning item may fall over and cause a fire.

If you notice any abnormality

- When one of the following problems occurs, immediately turn off the power switch and disconnect the electric plug from the outlet. Then have the device inspected by Yamaha service personnel.
 - The power cord or plug becomes frayed or damaged.
 - It emits unusual smells or smoke.
 - Some object has been dropped into the instrument.
 - There is a sudden loss of sound during use of the device.
- If this device should be dropped or damaged, immediately turn off the power switch, disconnect the electric plug from the outlet, and have the device inspected by qualified Yamaha service personnel.



CAUTION

Always follow the basic precautions listed below to avoid the possibility of physical injury to you or others, or damage to the device or other property. These precautions include, but are not limited to, the following:

Power supply/Power cord

- When removing the electric plug from the device or an outlet, always hold the plug itself and not the cord. Pulling by the cord can damage it.
- Remove the electric plug from the outlet when the device is not to be used for extended periods of time, or during electrical storms.

Location

- Do not place the device in an unstable position where it might accidentally fall over.
- Do not block the vents. This device has ventilation holes at the front and sides to prevent the internal temperature from becoming too high. In particular, do not place the device on its side or upside down. Inadequate ventilation can result in overheating, possibly causing damage to the device(s), or even fire.

- Do not place the device in a location where it may come into contact with corrosive gases or salt air. Doing so may result in malfunction.
- Keep device away from the reach of children.
- Before moving the device, remove all connected cables.
- When setting up the device, make sure that the AC outlet you are using is easily accessible. If some trouble or malfunction occurs, immediately turn off the power switch and disconnect the plug from the outlet. Even when the power switch is turned off, electricity is still flowing to the product at the minimum level. When you are not using the product for a long time, make sure to unplug the power cord from the wall AC outlet.
- If the device is mounted in an EIA standard rack, carefully read the section "Precautions for rackmounting" on page 10. Inadequate ventilation can result in overheating, possibly causing damage to the device(s), malfunction, or even fire.

Connections

- Before connecting the device to other devices, turn off the power for all devices. Before turning the power on or off for all devices, set all volume levels to minimum.

Maintenance

- Remove the power plug from the AC outlet when cleaning the device.

Handling caution

- Do not insert your fingers or hands in any gaps or openings on the device (vents).
- Avoid inserting or dropping foreign objects (paper, plastic, metal, etc.) into any gaps or openings on the device (vents). If this happens, turn off the power immediately and unplug the power cord from the AC outlet. Then have the device inspected by qualified Yamaha service personnel.
- Do not rest your weight on the device or place heavy objects on it, and avoid use excessive force on the buttons, switches or connectors.

Yamaha cannot be held responsible for damage caused by improper use or modifications to the device, or data that is lost or destroyed.

Always turn the power off when the device is not in use.

NOTICE

To avoid the possibility of malfunction/damage to the product, damage to data, or damage to other property, follow the notices below.

■ Handling and Maintenance

- Do not use the device in the vicinity of a TV, radio, stereo equipment, mobile phone, or other electric devices. Otherwise, the device, TV, or radio may generate noise.
- Do not expose the device to excessive dust or vibration, or extreme cold or heat (such as in direct sunlight, near a heater, or in a car during the day), in order to prevent the possibility of panel disfiguration, unstable operation, or damage to the internal components.
- Do not place vinyl, plastic or rubber objects on the device, since this might discolor the panel.
- When cleaning the device, use a dry and soft cloth. Do not use paint thinners, solvents, cleaning fluids, or chemical-impregnated wiping cloths.
- Condensation can occur in the device due to rapid, drastic changes in ambient temperature—when the device is moved from one location to another, or air conditioning is turned on or off, for example. Using the device while condensation is present can cause damage. If there is reason to believe that condensation might have occurred, leave the device for several hours without turning on the power until the condensation has completely dried out.
- When turning on the AC power in your audio system, always turn on the power amplifier LAST, to avoid speaker damage. When turning the power off, the power amplifier should be turned off FIRST for the same reason.

Information

■ About this manual

- The illustrations as shown in this manual are for instructional purposes only, and may appear somewhat different from those on your device.
- The company names and product names in this manual are the trademarks or registered trademarks of their respective companies.

European Models

Inrush Current based on EN 55103-1:2009

1A (on initial switch-on)

1A (after a supply interruption of 5s)

Conforms to Environments: E1, E2, E3 and E4

Contents

PRECAUTIONS	4
Getting Started	6
Features	6
Parameter settings of EXi8/EXo8	6
Firmware Updates	6
Included items (please check).....	6
Controls and Connectors	7
Front Panel.....	7
Rear Panel	8
Setup	10
Precautions for rackmounting.....	10
Euroblock plug connection	10
Initializing the EXi8/EXo8.....	11
Troubleshooting	12
Alert list	13
Appendix	90
Specifications	90
Input (EXi8) / Output (EXo8) Characteristics	91
Dimensions	92

Getting Started

Thank you for purchasing the Yamaha Input Expander EXi8/Output Expander EXo8. This manual will help you take full advantage of the superior functionality offered by the EXi8/EXo8. After you have read the manual, keep it in a safe place for reference when needed.

Features

Support for the newly-developed “YDIF” digital audio transmission format

“YDIF” is a digital audio transmission format that uses an Ethernet cable to send and receive up to 16 channels of audio and word clock. Up to eight YDIF devices (maximum of seven for the EXi8 and/or EXo8) can be connected to expand the number of input/output channels available for one system.

Enormous installation flexibility with compact 1U chassis

The EXi8 is an input expansion unit and the EXo8 is an output expansion unit. The expansion unit can be installed to locations where only either input or output is required.

Parameter settings of EXi8/EXo8

To make the EXi8/EXo8 parameter settings, use the system’s dedicated application software (MTX Editor: available for Windows OS only). The dedicated application software makes it easy to design a system and make (or adjust) its settings, resulting in the creation of an overall system design. The dedicated application software and manuals can be downloaded from the following web site.

<http://www.yamahaproaudio.com/global/en/>

NOTE

In order to view the downloaded manuals, Adobe Reader must be installed in your computer. If you don’t have Adobe Reader, please access the Adobe Corporation’s website at the following URL, and download Adobe Reader (free of charge).

<http://www.adobe.com/>

Firmware Updates

To update the firmware of the unit, you must use the system’s dedicated application software. For details on firmware updates, refer to the following web site.

<http://www.yamahaproaudio.com/global/en/downloads/>

Included items (please check)

- EXi8/EXo8 Owner’s Manual (this document)
- Power cable
- Euroblock plugs (3-pin, with tab, 5.08mm pitch) (8)
- Cable ties (8)

Controls and Connectors

Front Panel

● EXi8

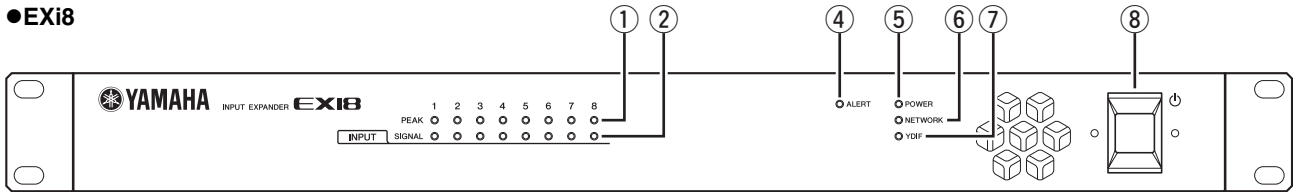

● EXo8

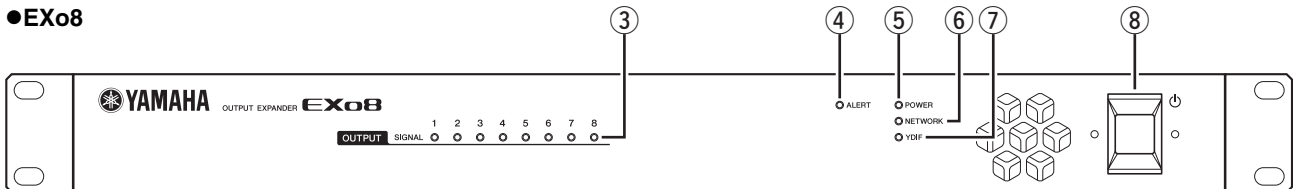

① [INPUT PEAK] indicators 1–8 (EXi8)

These indicators will light red when the input level of the corresponding INPUT channel is -3 dBFS or higher.

② [INPUT SIGNAL] indicators 1–8 (EXi8)

These indicators will light green when the input level of the corresponding INPUT channel is -40 dBFS or higher. When a problem or abnormality occurs in the unit, the indicator that corresponds to the appropriate alert number will flash in green together with the flashing front panel [ALERT] indicator.

③ [OUTPUT SIGNAL] indicators 1–8 (EXo8)

These indicators will light green when the output level of the corresponding OUTPUT channel is -40 dBFS or higher. When a problem or abnormality occurs in the unit, the indicator that corresponds to the appropriate alert number will flash in green together with the flashing front panel [ALERT] indicator.

④ [ALERT] indicator

When a problem or abnormality occurs in the unit, this indicator will flash in red and at the same time the [INPUT SIGNAL] or [OUTPUT SIGNAL] indicator that corresponds to the alert number will flash in green. For explanations of the alerts, refer to the “Alert list” on page 13.

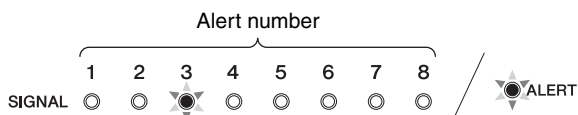

Example: When a problem related to alert number “3” occurs

⑤ [POWER] indicator

This indicator will light when this device is powered-on.



⑥ [NETWORK] indicator

This indicator will light green if a link is established with an external device via the rear panel NETWORK connector (page 9). It will flash while data is being sent or received.

⑦ [YDIF] indicator

This indicator will light green if the rear panel [YDIF IN] connector (page 9) is correctly connected to the [YDIF OUT] connector of another device.

⑧ Power switch

This is the power switch. The power is on if the switch is in the  position. The power is off if the switch is in the  position.

NOTE

- Do not cycle the power switch in rapid succession. Wait at least 6 seconds before turning the power switch on after it has been turned off. Failing to observe this precaution may cause malfunctions.
- Even when the power switch is turned off, a small amount of current is flowing through the unit. If you plan not to use the unit for a long period of time, remove the power cable from the AC outlet.

Rear Panel

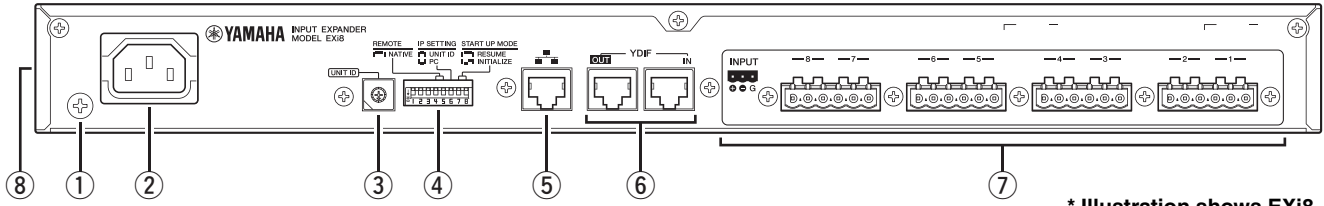

* Illustration shows EXi8.

NOTE

The EXi8/EXo8 has some connectors that are shaped identically but have a completely different function (e.g., NETWORK connector, [YDIF] connector). Make the appropriate connections as instructed by the explanation for each connector. Otherwise, you risk damaging your equipment.

① Ground screw

The supplied power cord has a three-prong plug that will ground the device when plugged into an appropriately grounded three-prong type AC mains outlet. In some cases, you may be able to reduce hum or interference by also connecting this screw to ground.

② AC IN connector

Use the included power cord to supply power to this connector. First, connect the power cord to this device, and then insert the power cord plug into the AC outlet.

③ [UNIT ID] rotary switch

This switch specifies the ID by which EXi8/EXo8 units are individually distinguished in the MTX system network. You must specify the ID avoiding duplicates among the MTX series, XMV series and the EXi8/EXo8 within the same network.

DIP switches 1 and 2 described in ④ specify the upper digit, and this rotary switch specifies the lower digit, together allowing you to set the UNIT ID to one of 63 possibilities in the range of 01 to 3F.

NOTE

- Do not use a UNIT ID of "00" (DIP switches 1 and 2 upward and the rotary switch at 0).
- You'll need to restart the device after changing the setting of the [UNIT ID] rotary switch.

④ DIP switches

These switches enable you to specify the settings related to the startup operation of the EXi8/EXo8.

NOTE

Set the DIP switches while the power to the unit is turned OFF. Otherwise, the setting will not be effective.

Refer to the following for details.

Switch	Status
	Represent a status with switch toggled up.
	Represent a status with switch toggled down.

● Switches 1–2 (UNIT ID)

These switches specify the upper digit and the above-mentioned [UNIT ID] rotary switch specifies the lower digit, together allowing you to specify one of 63 different UNIT ID numbers in a range from 01 to 3F.

Switch position	Option	Functions
	UNIT ID is "0x"	The [UNIT ID] rotary switch will have a setting range of 01 through 0F.
	UNIT ID is "1x"	The [UNIT ID] rotary switch will have a setting range of 10 through 1F.
	UNIT ID is "2x"	The [UNIT ID] rotary switch will have a setting range of 20 through 2F.
	UNIT ID is "3x"	The [UNIT ID] rotary switch will have a setting range of 30 through 3F.

NOTE

Do not use a UNIT ID of "00" (DIP switches 1 and 2 upward and the rotary switch at 0).

● Switch 3

This switch is for future expansion. Set this to its upward position.



● Switches 4–5 (REMOTE)

Settings of these switches are not necessary. Set these to their upward position.

Switch position	Option	Function
	NATIVE	Enables remote control with the supported devices.

● **Switch 6 (IP SETTING)**

This switch specifies how the EXi8/EXo8's IP address will be specified.



Switch position	Option	Functions
	UNIT ID	The IP address will be specified according to the UNIT ID, and will be 192.168.0.(UNIT ID).
	PC	The IP address will be determined by the settings of the system's application software. (See the user's manual of the corresponding application software.)

NOTE

Set this to the "UNIT ID" position the first time you connect this device to a computer after purchase. After specifying the IP address from the system's dedicated application software, change this switch to the "PC" position.

● **Switches 7–8 (START UP MODE)**

These specify whether the EXi8/EXo8 will be initialized when it is powered-on.

Switch position	Option	Functions
	RESUME	This is the normal operating mode. When you power-on the EXi8/EXo8, it will start up in the same state in which it was when the power was turned off.
	INITIALIZE	Initializes the EXi8/EXo8, returning it to the factory-set state (page 11).

⑤ **NETWORK connector**

This is an Ethernet connector that supports AutoMDI/MDI-X. It enables communication via a network switch with an MTX network or external controller. Use a CAT5e or better Ethernet STP cable (shielded twisted pair cable).

⑥ **[YDIF] connectors**

These connectors are used to make a ring connection with the devices that comprise the system, allowing digital audio signals to be transmitted and received. Use CAT5e or better Ethernet STP cables (shielded twisted pair cables) that have all eight pins connected in a straight connection. The maximum cable length between devices is 30 meters, and you can connect up to total seven EXi8 and EXo8 devices. For details, refer to the user's manual of the corresponding application software.

⑦ **[INPUT] connectors (EXi8)
[OUTPUT] connectors (EXo8)**

These are balanced input/output connectors for analog audio input and output. Connect line level devices or microphones to the [INPUT] connectors, and line level devices to the [OUTPUT] connectors. The [INPUT] connectors provide head amps, and can also provide +48V phantom power. The system's dedicated application software is used to specify the gain of the internal head amps and to turn the phantom power on/off.

Use the included Euroblock plugs to make connections (see "Euroblock plug connection" on page 10 for details).

NOTE

Adjusting the internal head amp gain between +17 dB and +18 dB will internally turn PAD on/off. Noise may occur if there is an impedance difference between the Hot and Cold of a device connected to the [INPUT] connectors while phantom power is being used.

⑧ **Cooling vent**

The EXi8/EXo8 contains a cooling fan. The cooling air is exhausted here, so please be careful not to block this vent.

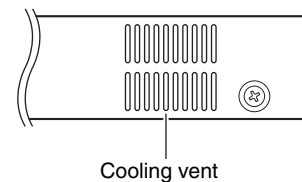

Setup

Precautions for rackmounting

This device is guaranteed to operate at an ambient temperature of 0 to 40 °C. If this device is mounted in an EIA rack together with other devices, heat from the various devices may cause the temperature inside the rack to rise, rendering this device unable to perform to its full potential. To ensure that heat does not accumulate inside this device, please ensure that the following conditions are met when rack-mounting it.

- If you plan to mount this device together with devices that tend to generate heat, such as power amps, allow 1U or more of vacant space between this device and other devices. (However, you do not need larger than 1U space with the MTX series or XMV series.) Also attach ventilation panels in this space or leave them open to ensure sufficient ventilation.
- Leave the back of the rack open, and allow at least 10 cm of space between the rack and the wall or ceiling to ensure sufficient ventilation. If the back of the rack cannot be left open, provide forced air cooling for the rack, for example by installing a commercially available fan kit. If you install a fan kit, leaving the back of the rack closed may provide more effective cooling. For details, refer to the owner's manual provided with the rack or fan kit.

Euroblock plug connection

Use the included Euroblock plugs when making connections to the [INPUT]/[OUTPUT] connectors.

Cable preparation

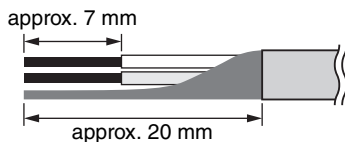

- Use stranded wire for Euroblock connections, and strip the wire as shown in the illustration. With a Euroblock connection, the stranded wire may be prone to breakage because of metal fatigue due to the weight of the cable or due to vibration. Cables connected to the [INPUT]/[OUTPUT] connectors should be fastened to the tab of the Euroblock plug (3-pin) using the included cable ties (see illustration at right). When rack-mounting the device, use a lacing bar when possible to bundle and secure the cable.

NOTE

Do not tin (plate with solder) the stranded wire.

- If cables will be frequently connected and disconnected, as in the case of a portable system, we recommend that you use ferrules with insulation sleeves. Use a ferrule whose conductor portion has an external diameter of 1.6 mm or less and a length of approximately 7 mm such as the AI 0,5 - 6 WH made by the Phoenix Contact corporation.

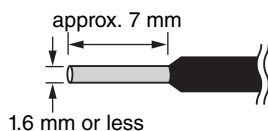

1. Loosen the terminal screws.

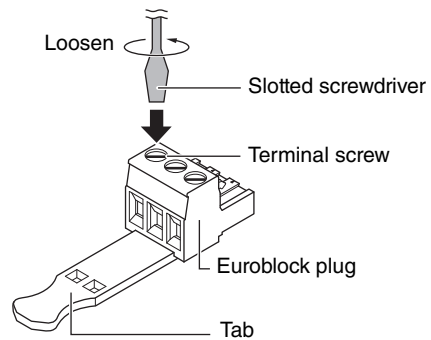

NOTE

Use a slotted screwdriver with a blade width of 3 mm or less.

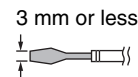

2. Insert cables.

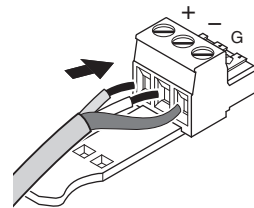

3. Securely tighten the terminal screws.

Pull the cables (not too strongly) to confirm that they are securely connected.

4. Use the included cable ties to fasten the cable to the tab.

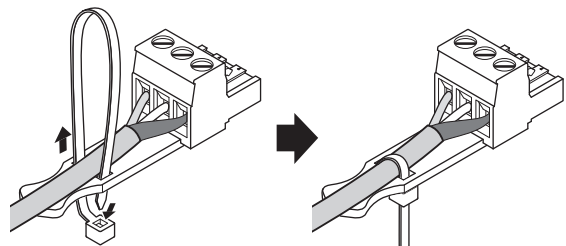

NOTE

Trim off the extra portion of the cable tie as necessary.

5. Plug the Euroblock plug into the [INPUT] connector of the EXi8 or the [OUTPUT] connector of the EXo8.

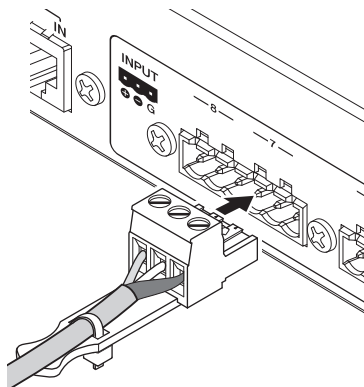

NOTE

When connecting unbalanced cables to the [INPUT] connector, use a jumper wire to connect the “-” and “G” of the Euroblock.

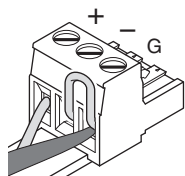

Initializing the EXi8/EXo8

Here’s how to initialize the EXi8/EXo8’s internal memory, restoring it to the factory settings.

1. Power-off the EXi8/EXo8.
2. Set the rear panel DIP switches 7 and 8 to the “INITIALIZE” position.



3. Power-on the EXi8/EXo8.

Initialization will start.

The status of execution is shown by the [ALERT], [NETWORK], and [YDIF] indicators on the front panel.

• During initialization:

The [NETWORK] indicator and the [YDIF] indicator will flash rapidly.



• Initialization completed:

The [NETWORK] indicator and the [YDIF] indicator will flash slowly.

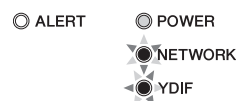

• Initialization failed:

The [ALERT] indicator will flash.

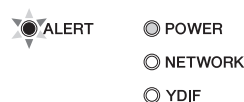

⚠ CAUTION

Do not turn off the power to the EXi8/EXo8 during initialization. Otherwise, a malfunction may occur

NOTE

If initialization failed, contact Yamaha representatives / authorized distributors to have the device inspected. A list of Yamaha representatives / authorized distributors appears near the end of this manual.

4. When initialization is completed, power-off the EXi8/EXo8 once again.
5. Set the rear panel DIP switches 7 and 8 to the “RESUME” position.



6. Power-on the EXi8/EXo8 again.

The EXi8/EXo8 will start up in its factory-set state.

Troubleshooting

An FAQ (frequently asked questions) list is at the Yamaha Pro Audio web site (<http://www.yamahaproaudio.com/>).

Symptom	Possible cause, and action
The device does not turn on, or the panel LEDs do not light up.	Connect the power cord properly.
	Make sure that the power switch is turned on.
	If the power still does not turn on, contact your Yamaha dealer.
Cannot exchange data between the EXi8/EXo8 and system's dedicated application software. (EXi8/EXo8 is not shown in the dedicated application software)	Is the NETWORK connector on the EXi8/EXo8 properly connected to your computer?
	Have you specified the correct UNIT ID using the [UNIT ID] rotary switch and DIP switches 1 and 2 on the rear panel? Could the UNIT ID be conflicting with another device?
	Set the rear panel DIP switch 6 (IP SETTING) to "UNIT ID" so that the IP address will be automatically assigned according to the UNIT ID.
No audio input is present. ([INPUT SIGNAL] indicator does not light)	Connect the cable properly.
	Make sure that a signal from an external device is being input.
	Set the gain of the internal head amplifier or external head amplifier to an appropriate level.
No audio is output. ([OUTPUT SIGNAL] indicator does not light)	Could the output level be lowered?
	In the system's dedicated application software, could the channel's ON button be turned off?
	Is the signal routing specified correctly?
	Have settings such as patch, gain or level in the system's dedicated application software been made correctly?
[YDIF] indicator does not light	Did you use an appropriate cable to make proper YDIF connections between the EXi8/EXo8 and other devices in the system? Also, is the power to the YDIF-connected devices turned on?
The [ALERT] indicator is flashing	An error has occurred. The [INPUT SIGNAL] indicator or the [OUTPUT SIGNAL] indicator that corresponds to the alert number flashes; refer to the "Alert list" on page 13 to determine the problem and take appropriate action.

Alert list

Flashing [SIGNAL] indicator (alert number)	Meaning	Response
1	The device has not started up correctly.	Turn the power off, then turn on after waiting at least 6 seconds. If this does not solve the problem, please initialize the memory. Should this also fail, contact your Yamaha dealer.
2	The current preset saved in internal memory has been lost.	Recall the preset. If this does not solve the problem, contact your Yamaha dealer.
3	The word clock master has become unlocked.	Make sure that the word clock signal is being input correctly.
4	There is a problem with the connection of the [YDIF IN] connector.	Make sure that YDIF cables are properly connected. Use cables that meet the required specifications.
5	Duplicate IP addresses.	Change the IP addresses or UNIT ID so that there are no duplicates.
	IP address was not set within 60 seconds of startup.	Please check rear panel DIP switch 6 (IP SETTING). If DIP switch 6 is set to "PC," use the system's dedicated application software or the DHCP server to specify the device IP address.
	Too many devices are connected to the network.	Reduce the number of devices connected to the network.
6	The UNIT ID is set to "00."	Set the UNIT ID to something other than "00."
	Devices with identical UNIT IDs were found connected within the same network.	Change the UNIT ID so that there are no duplicates.

Appendix

■ Specifications

Product specifications	
Dimensions (W x H x D)	480(W) x 44(H) x 351(D)mm, 1U
Weight	4.3 kg
Power supply voltage	Japan: 100V 50/60Hz US/Canada: 110V–240V 50/60Hz Others: 100V–240V 50/60Hz
Power consumption	25 W max.
Heat dissipation (per hour)	21.5 kcal max.
Operating temperature range	0 °C–40 °C
Storage temperature range	-20 °C–60 °C
NC value	24 (1m from the front panel)
Maximum number of simultaneously usable devices	A total of seven EXi8 and EXo8 devices. (However in a system, a total of up to 20 devices, including devices such as the MTX series and XMV series, can be used.)
Power cord length	2.5m
Included items	Power cord, Euroblock plugs (3-pin, tabbed) x 8, cable ties x 8, Owner's manual

Electrical specifications	
Sampling frequency	48kHz/44.1kHz
Signal delay	Less than 2.5ms
Frequency response	20Hz to 20kHz, -1.5dB min, 0dB typ., +0.5dB max.
Total harmonic distortion	Less than 0.05% (+4dBu, Gain:-6dB); less than 0.1% (+4dBu, Gain:+66dB)
Dynamic range	107dB (Gain:-6dB)
Equivalent input noise (EIN)	-126dBu (Gain: +66dB)
Crosstalk / Channel separation	-100dB (@ 1kHz)
Maximum cable length	[YDIF] connector: 30 meters (Cable length between devices)
Indicators	INPUT PEAK (EXi8): RED -3dBFS INPUT SIGNAL (EXi8): GREEN -40dBFS OUTPUT SIGNAL (EXo8): GREEN -40dBFS
Phantom power (EXi8)	+48V (per channel; individually settable)

Connector specifications	
Format	NETWORK connector: 100Base-TX
Cable specifications	[YDIF] connector: CAT5e or better Ethernet STP cable (Straight connected. All 8 pins must be connected.) NETWORK connector: CAT5e or better Ethernet STP cable

■ Input (EXi8) / Output (EXo8) Characteristics

ANALOG INPUT CHARACTERISTICS (EXi8)

Input Terminals	GAIN	Actual Load Impedance	For Use With Nominal	Input Level		Connector
				Nominal	Max. before clip	
INPUT 1–8	+66dB	10k Ω	50–600 Ω Mics & 600 Ω Lines	-62dBu (0.616mV)	-42dBu (6.16mV)	Euroblock (Balanced) (5.08mm pitch)
	-6dB			+10dBu (2.45V)	+30dBu (24.5V)	

- In these specifications, 0dBu = 0.775 Vrms.
- All input AD converters are 24bit linear, 128times oversampling.
- +48V DC (phantom power) is supplied to INPUT Euroblock connectors via each individual software controlled switch.

ANALOG OUTPUT CHARACTERISTICS (EXo8)

Output Terminals	Actual Source Impedance	For Use With Nominal	Output Level		Connector
			Nominal	Max. before clip	
OUTPUT 1–8	75 Ω	10k Ω Lines	+4dBu (1.23 V)	+24dBu (12.3V)	Euroblock (Balanced) (5.08mm pitch)

- In these specifications, 0dBu = 0.775 Vrms.
- All output DA converters are 24bit, 128times oversampling. (Fs=48kHz)

* Specifications and descriptions in this owner's manual are for information purposes only. Yamaha Corp. reserves the right to change or modify products or specifications at any time without prior notice. Since specifications, equipment or options may not be the same in every locale, please check with your Yamaha dealer.

* Die technischen Daten und Beschreibungen in dieser Bedienungsanleitung dienen nur der Information. Yamaha Corp. behält sich das Recht vor, Produkte oder deren technische Daten jederzeit ohne vorherige Ankündigung zu verändern oder zu modifizieren. Da die technischen Daten, das Gerät selbst oder Sonderzubehör nicht in jedem Land gleich sind, setzen Sie sich im Zweifel bitte mit Ihrem Yamaha-Händler in Verbindung.

* Les caractéristiques techniques et les descriptions du mode d'emploi ne sont données que pour information. Yamaha Corp. se réserve le droit de changer ou modifier les produits et leurs caractéristiques techniques à tout moment sans aucun avis. Du fait que les caractéristiques techniques, les équipements et les options peuvent différer d'un pays à l'autre, adressez-vous au distributeur Yamaha le plus proche.

* Las especificaciones y descripciones de este manual del propietario tienen sólo el propósito de servir como información. Yamaha Corp. se reserva el derecho a efectuar cambios o modificaciones en los productos o especificaciones en cualquier momento sin previo aviso. Puesto que las especificaciones, equipos u opciones pueden no ser las mismas en todos los mercados, solicite información a su distribuidor Yamaha.

* Le specifiche e le descrizioni presenti in questo manuale sono fornite a fini puramente informativi. Yamaha Corp. si riserva il diritto di modificare prodotti o specifiche in qualsiasi momento senza preavviso. Dato che le specifiche, le apparecchiature o le opzioni possono essere diverse da paese a paese, verificarle con il proprio rappresentante Yamaha.

* Технические характеристики и их описания в данном руководстве пользователя предназначены только для общего сведения. Корпорация Yamaha сохраняет за собой право модифицировать свои изделия и менять их технические характеристики без предварительного уведомления. Поскольку технические характеристики, оборудование и набор возможностей могут зависеть от региона, обращайтесь за информацией к местному представителю корпорации Yamaha.

* 本使用说明书中的技术规格及介绍仅供参考。Yamaha公司保留随时更改或修订产品或技术规格的权利，若确有更改，恕不事先通知。技术规格、设备或选购件在各个地区可能均会有所不同，因此如有问题，请与当地Yamaha经销商确认。

* 仕様および外觀は、改良のため予告なく変更することがあります。

■ Dimensions

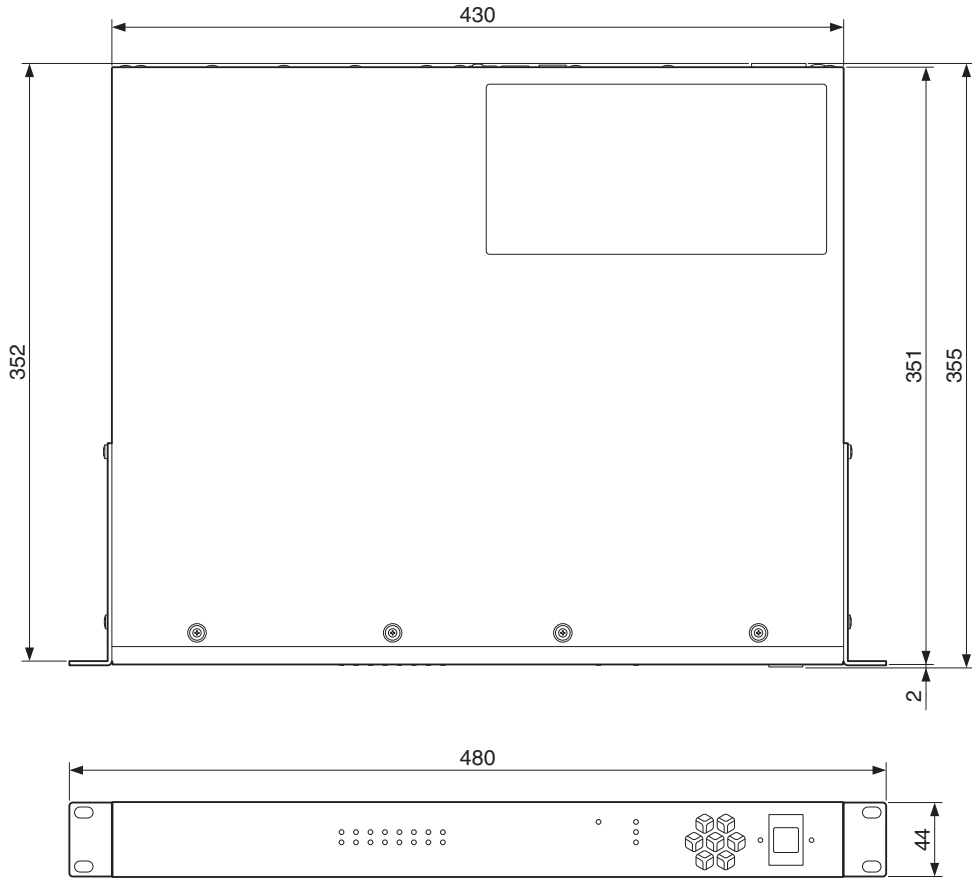

Unit: mm

Information for Users on Collection and Disposal of Old Equipment



This symbol on the products, packaging, and/or accompanying documents means that used electrical and electronic products should not be mixed with general household waste.

For proper treatment, recovery and recycling of old products, please take them to applicable collection points, in accordance with your national legislation and the Directives 2002/96/EC.

By disposing of these products correctly, you will help to save valuable resources and prevent any potential negative effects on human health and the environment which could otherwise arise from inappropriate waste handling.

For more information about collection and recycling of old products, please contact your local municipality, your waste disposal service or the point of sale where you purchased the items.

[For business users in the European Union]

If you wish to discard electrical and electronic equipment, please contact your dealer or supplier for further information.

[Information on Disposal in other Countries outside the European Union]

This symbol is only valid in the European Union. If you wish to discard these items, please contact your local authorities or dealer and ask for the correct method of disposal.

(weee_eu_en_01)

Verbraucherinformation zur Sammlung und Entsorgung alter Elektrogeräte



Beendet sich dieses Symbol auf den Produkten, der Verpackung und/oder beiliegenden Unterlagen, so sollten benutzte elektrische Geräte nicht mit dem normalen Haushaltsabfall entsorgt werden.

In Übereinstimmung mit Ihren nationalen Bestimmungen und den Richtlinien 2002/96/EC bringen Sie alte Geräte bitte zur fachgerechten Entsorgung, Wiederaufbereitung und Wiederverwendung zu den entsprechenden Sammelstellen.

Durch die fachgerechte Entsorgung der Elektrogeräte helfen Sie, wertvolle Ressourcen zu schützen, und verhindern mögliche negative Auswirkungen auf die menschliche Gesundheit und die Umwelt, die andernfalls durch unsachgerechte Müllentsorgung auftreten könnten.

Für weitere Informationen zum Sammeln und Wiederaufbereiten alter Elektrogeräte kontaktieren Sie bitte Ihre örtliche Stadt- oder Gemeindeverwaltung, Ihren Abfallentsorgungsdienst oder die Verkaufsstelle der Artikel.

[Information für geschäftliche Anwender in der Europäischen Union]

Wenn Sie Elektrogeräte ausrangieren möchten, kontaktieren Sie bitte Ihren Händler oder Zulieferer für weitere Informationen.

[Entsorgungsinformation für Länder außerhalb der Europäischen Union]

Dieses Symbol gilt nur innerhalb der Europäischen Union. Wenn Sie solche Artikel ausrangieren möchten, kontaktieren Sie bitte Ihre örtlichen Behörden oder Ihren Händler und fragen Sie nach der sachgerechten Entsorgungsmethode.

(weee_eu_de_01)

Information concernant la Collecte et le Traitement des déchets d'équipements électriques et électroniques.



Le symbole sur les produits, l'emballage et/ou les documents joints signifie que les produits électriques ou électroniques usagés ne doivent pas être mélangés avec les déchets domestiques habituels.

Pour un traitement, une récupération et un recyclage appropriés des déchets d'équipements électriques et électroniques, veuillez déposer aux points de collecte prévus à cet effet, conformément à la réglementation nationale et aux Directives 2002/96/EC.

En vous débarrassant correctement des déchets d'équipements électriques et électroniques, vous contribuerez à la sauvegarde de précieuses ressources et à la prévention de potentiels effets négatifs sur la santé humaine qui pourraient advenir lors d'un traitement inapproprié des déchets.

Pour plus d'informations à propos de la collecte et du recyclage des déchets d'équipements électriques et électroniques, veuillez contacter votre municipalité, votre service de traitement des déchets ou le point de vente où vous avez acheté les produits.

[Pour les professionnels dans l'Union Européenne]

Si vous souhaitez vous débarrasser des déchets d'équipements électriques et électroniques veuillez contacter votre vendeur ou fournisseur pour plus d'informations.

[Information sur le traitement dans d'autres pays en dehors de l'Union Européenne]

Ce symbole est seulement valable dans l'Union Européenne. Si vous souhaitez vous débarrasser de déchets d'équipements électriques et électroniques, veuillez contacter les autorités locales ou votre fournisseur et demander la méthode de traitement appropriée.

(weee_eu_fr_01)

Información para Usuarios sobre Recolección y Disposición de Equipamiento Viejo



Este símbolo en los productos, embalaje, y/o documentación que se acompañe significa que los productos electrónicos y eléctricos usados no deben ser mezclados con desechos hogareños corrientes.

Para el tratamiento, recuperación y reciclado apropiado de los productos viejos, por favor llévelos a puntos de recolección aplicables, de acuerdo a su legislación nacional y las directivas 2002/96/EC.

Al disponer de estos productos correctamente, ayudará a ahorrar recursos valiosos y a prevenir cualquier potencial efecto negativo sobre la salud humana y el medio ambiente, el cual podría surgir de un inapropiado manejo de los desechos.

Para mayor información sobre recolección y reciclado de productos viejos, por favor contacte a su municipio local, su servicio de gestión de residuos o el punto de venta en el cual usted adquirió los artículos.

[Para usuarios de negocios en la Unión Europea]

Si usted desea deshacerse de equipamiento eléctrico y electrónico, por favor contacte a su vendedor o proveedor para mayor información.

[Información sobre la Disposición en otros países fuera de la Unión Europea]

Este símbolo sólo es válido en la Unión Europea. Si desea deshacerse de estos artículos, por favor contacte a sus autoridades locales y pregunte por el método correcto de disposición.

(weee_eu_es_01)

Informazioni per gli utenti sulla raccolta e lo smaltimento di vecchia attrezzatura



Questo simbolo sui prodotti, sull'imballaggio e/o sui documenti che li accompagnano significa che i prodotti elettrici ed elettronici non dovrebbero essere mischiati con i rifiuti domestici generici.

Per il trattamento, recupero e riciclaggio appropriati di vecchi prodotti, li porti, prego, ai punti di raccolta appropriati, in accordo con la Sua legislazione nazionale e le direttive 2002/96/CE.

Smaltendo correttamente questi prodotti, Lei aiuterà a salvare risorse preziose e a prevenire alcuni potenziali effetti negativi sulla salute umana e l'ambiente, che altrimenti potrebbero sorgere dal trattamento improprio dei rifiuti.

Per ulteriori informazioni sulla raccolta e il riciclaggio di vecchi prodotti, prego contatti la Sua amministrazione comunale locale, il Suo servizio di smaltimento dei rifiuti o il punto vendita dove Lei ha acquistato gli articoli.

[Per utenti imprenditori dell'Unione europea]

Se Lei desidera disfarsi di attrezzatura elettrica ed elettronica, prego contatti il Suo rivenditore o fornitore per ulteriori informazioni.

[Informazioni sullo smaltimento negli altri Paesi al di fuori dell'Unione europea]

Questo simbolo è valido solamente nell'Unione Europea. Se Lei desidera disfarsi di questi articoli, prego contatti le Sue autorità locali o il rivenditore e richieda la corretta modalità di smaltimento.

(weee_eu_it_01)

Important Notice: Guarantee Information for customers in European Economic Area (EEA) and Switzerland

<p>Important Notice: Guarantee Information for customers in EEA* and Switzerland</p> <p>For detailed guarantee information about this Yamaha product, and Pan-EEA* and Switzerland warranty service, please either visit the website address below (Printable file is available at our website) or contact the Yamaha representative office for your country. * EEA: European Economic Area</p>	English
<p>Wichtiger Hinweis: Garantie-Information für Kunden in der EWR* und der Schweiz</p> <p>Für nähere Garantie-Information über dieses Produkt von Yamaha, sowie über den Pan-EWR*- und Schweizer Garantieservice, besuchen Sie bitte entweder die folgend angegebene Internetadresse (eine druckfähige Version befindet sich auch auf unserer Webseite), oder wenden Sie sich an den für Ihr Land zuständigen Yamaha-Vertrieb. * EWR: Europäischer Wirtschaftsraum</p>	Deutsch
<p>Remarque importante: informations de garantie pour les clients de l'EEE et la Suisse</p> <p>Pour des informations plus détaillées sur la garantie de ce produit Yamaha et sur le service de garantie applicable dans l'ensemble de l'EEE ainsi qu'en Suisse, consultez notre site Web à l'adresse ci-dessous (le fichier imprimable est disponible sur notre site Web) ou contactez directement Yamaha dans votre pays de résidence. * EEE : Espace Economique Européen</p>	Français
<p>Belangrijke mededeling: Garantie-informatie voor klanten in de EER* en Zwitserland</p> <p>Voor gedetailleerde garantie-informatie over dit Yamaha-product en de garantieservice in heel de EER* en Zwitserland, gaat u naar de onderstaande website (u vindt een afdrukbaar bestand op onze website) of neemt u contact op met de vertegenwoordiging van Yamaha in uw land. * EER: Europese Economische Ruimte</p>	Nederlands
<p>Aviso importante: información sobre la garantía para los clientes del EEE* y Suiza</p> <p>Para una información detallada sobre este producto Yamaha y sobre el soporte de garantía en la zona EEE* y Suiza, visite la dirección web que se incluye más abajo (la versión del archivo para imprimir esta disponible en nuestro sitio web) o póngase en contacto con el representante de Yamaha en su país. * EEE: Espacio Económico Europeo</p>	Español
<p>Avviso importante: informazioni sulla garanzia per i clienti residenti nell'EEA* e in Svizzera</p> <p>Per informazioni dettagliate sulla garanzia relativa a questo prodotto Yamaha e l'assistenza in garanzia nei paesi EEA* e in Svizzera, potete consultare il sito Web all'indirizzo riportato di seguito (è disponibile il file in formato stampabile) oppure contattare l'ufficio di rappresentanza locale della Yamaha. * EEA: Area Economica Europea</p>	Italiano
<p>Aviso importante: informações sobre as garantias para clientes da AEE* e da Suíça</p> <p>Para obter uma informação pormenorizada sobre este produto da Yamaha e sobre o serviço de garantia na AEE* e na Suíça, visite o site a seguir (o arquivo para impressão está disponível no nosso site) ou entre em contato com o escritório de representação da Yamaha no seu país. * AEE: Área Económica Europeia</p>	Português
<p>Σημαντική σημείωση: Πληροφορίες εγγύησης για τους πελάτες στον ΕΟΧ* και Ελβετία</p> <p>Για λεπτομερείς πληροφορίες εγγύησης σχετικά με το παρόν προϊόν της Yamaha και την κάλυψη εγγύησης σε όλες τις χώρες του ΕΟΧ και την Ελβετία, επισκεφτείτε την παρακάτω ιστοσελίδα (Εκτυπώσιμη μορφή είναι διαθέσιμη στην ιστοσελίδα μας) ή απευθυνθείτε στην αντιπροσωπεία της Yamaha στη χώρα σας. * ΕΟΧ: Ευρωπαϊκός Οικονομικός Χώρος</p>	Ελληνικά
<p>Viktigt: Garantiinformation för kunder i EES-området* och Schweiz</p> <p>För detaljerad information om denna Yamahaprodukt samt garantiservice i hela EES-området* och Schweiz kan du antingen besöka nedanstående webbadress (en utskriftsvänlig fil finns på webbplatsen) eller kontakta Yamahas officiella representant i ditt land. * EES: Europeiska Ekonomiska Samarbetsområdet</p>	Svenska
<p>Viktig merknad: Garantiinformasjon for kunder i EØS* og Sveits</p> <p>Detaljert garantiinformasjon om dette Yamaha-produktet og garantiservice for hele EØS-området* og Sveits kan fås enten ved å besøke nettstedene nedenfor (utskriftsversjon finnes på våre nettsider) eller kontakte Yamahas kontoret i landet der du bor. * EØS: Det europeiske økonomiske samarbeidsområdet</p>	Norsk
<p>Vigtig oplysning: Garantioplysninger til kunder i EØO* og Schweiz</p> <p>De kan finde detaljerede garantioplysninger om dette Yamaha-produkt og den fælles garantiserviceordning for EØO* (og Schweiz) ved at besøge det websted, der er angivet nedenfor (der findes en fil, som kan udskrives, på vores websted), eller ved at kontakte Yamahas nationale repræsentationskontor i det land, hvor De bor. * EØO: Det Europæiske Økonomiske Område</p>	Dansk
<p>Tärkeä ilmoitus: Takuutiedot Euroopan talousalueen (ETA)* ja Sveitsin asiakkaille</p> <p>Tämän Yamaha-tuotteen sekä ETA-alueen ja Sveitsin takuuta koskevat yksityiskohtaiset tiedot saatte alla olevasta nettiosoitteesta. (Tulostettava tiedosto saatavissa sivustollamme.) Voitte myös ottaa yhteyttä paikalliseen Yamaha-edustajaan. *ETA: Euroopan talousalue</p>	Suomi
<p>Ważne: Warunki gwarancyjne obowiązujące w EOG* i Szwajcarii</p> <p>Aby dowiedzieć się więcej na temat warunków gwarancyjnych tego produktu firmy Yamaha i serwisu gwarancyjnego w całym EOG* i Szwajcarii, należy odwiedzić wskazaną poniżej stronę internetową (Plik gotowy do wydruku znajduje się na naszej stronie internetowej) lub skontaktować się z przedstawicielstwem firmy Yamaha w swoim kraju. * EOG — Europejski Obszar Gospodarczy</p>	Polski
<p>Důležité oznámení: Záruční informace pro zákazníky v EHS* a ve Švýcarsku</p> <p>Podrobné záruční informace o tomto produktu Yamaha a záručním servisu v celém EHS* a ve Švýcarsku naleznete na níže uvedené webové adrese (soubor k tisku je dostupný na našich webových stránkách) nebo se můžete obrátit na zastoupení firmy Yamaha ve své zemi. * EHS: Evropský hospodářský prostor</p>	Česky
<p>Fontos figyelmeztetés: Garancia-információk az EGT* területén és Svájcban élő vásárlók számára</p> <p>A jelen Yamaha termékre vonatkozó részletes garancia-információk, valamint az EGT*-re és Svájcra kiterjedő garanciális szolgáltatás tekintetében keresse fel webhelyünket az alábbi címen (a webhelyen nyomtatható fájl is talál), vagy pedig lépjen kapcsolatba az országában működő Yamaha képviselői irodával. * EGT: Európai Gazdasági Térség</p>	Magyar
<p>Oluline märkus: Garantiiteave Euroopa Majanduspiirkonna (EMP)* ja Šveitsi klientidele</p> <p>Täpsemat teabe saamiseks selle Yamaha toote garantii ning kogu Euroopa Majanduspiirkonna ja Šveitsi garantiiteeninduse kohta, külastage palun veebisaiti alljärgneval aadressil (meie saidil on saadaval printitav fail) või pöörduge Teie regiooni Yamaha esinduse poole. * EMP: Euroopa Majanduspiirkond</p>	Eesti keel
<p>Svarīgs paziņojums: garantijas informācija klientiem EEZ* un Šveicē</p> <p>Lai saņemtu detalizētu garantijas informāciju par šo Yamaha produktu, kā arī garantijas apkalpošanu EEZ* un Šveicē, lūdzu, apmeklējiet zemāk norādīto tīmekļa vietnes adresi (tīmekļa vietnē ir pieejams drukājams fails) vai sazinieties ar jūsu valstī apkalpojošo Yamaha pārstāvniecību. * EEZ: Eiropas Ekonomikas zona</p>	Latviešu
<p>Dēmesio: informacija dėl garantijos pirkėjams EEE* ir Šveicarijoje</p> <p>Jei reikia išsamios informacijos apie šį „Yamaha“ produktą ir jo techninę priežiūrą visoje EEE* ir Šveicarijoje, apsilankykite mūsų svetainėje toliau nurodytu adresu (svetainėje yra spausdintinas failas) arba kreipkitės į „Yamaha“ atstovybę savo šaliai. * EEE – Europos ekonominė erdvė</p>	Lietuvių kalba
<p>Dôležité upozornenie: Informácie o záruke pre zákazníkov v EHP* a Švajčiarsku</p> <p>Podrobné informácie o záruke týkajúce sa tohto produktu od spoločnosti Yamaha a garančnom servise v EHP* a Švajčiarsku nájdete na webovej stránke uvedenej nižšie (na našej webovej stránke je k dispozícii súbor na tlač) alebo sa obráťte na zástupcu spoločnosti Yamaha vo svojej krajine. * EHP: Európsky hospodársky priestor</p>	Slovenčina
<p>Pomembno obvestilo: Informacije o garanciji za kupce v EGP* in Švici</p> <p>Za podrobnejše informacije o tem Yamahinem izdelku ter garancijskem servisu v celotnem EGP in Švici, obiščite spletno mesto, ki je navedeno spodaj (natisljiva datoteka je na voljo na našem spletnem mestu), ali se obrnite na Yamahinega predstavnika v svoji državi. * EGP: Evropski gospodarski prostor</p>	Slovenščina
<p>Важно съобщение: Информация за гаранцията за клиенти в ЕИП* и Швейцария</p> <p>За подробна информация за гаранцията за този продукт на Yamaha и гаранционното обслужване в паневропейската зона на ЕИП* и Швейцария или посетете посочения по-долу уеб сайт (на нашия уеб сайт има файл за печат), или се свържете с представителния офис на Yamaha във вашата страна. * ЕИП: Европейско икономическо пространство</p>	Български език
<p>Notificare importantă: Informații despre garanție pentru clienții din SEE* și Elveția</p> <p>Pentru informații detaliate privind acest produs Yamaha și serviciul de garanție Pan-SEE* și Elveția, vizitați site-ul la adresa de mai jos (fișierul imprimabil este disponibil pe site-ul nostru) sau contactați biroul reprezentanței Yamaha din țara dumneavoastră. * SEE: Spațiul Economic European</p>	Limba română

<http://europe.yamaha.com/warranty/>

For details of products, please contact your nearest Yamaha representative or the authorized distributor listed below.

Pour plus de détails sur les produits, veuillez-vous adresser à Yamaha ou au distributeur le plus proche de vous figurant dans la liste suivante.

Die Einzelheiten zu Produkten sind bei Ihrer unten aufgeführten Niederlassung und bei Yamaha Vertragshändlern in den jeweiligen Bestimmungsländern erhältlich.

Para detalles sobre productos, contacte su tienda Yamaha más cercana o el distribuidor autorizado que se lista debajo.

NORTH AMERICA

CANADA

Yamaha Canada Music Ltd.
135 Milner Avenue, Toronto, Ontario,
M1S 3R1, Canada
Tel: 416-298-1311

U.S.A.

Yamaha Corporation of America
6600 Orangethorpe Avenue, Buena Park, CA 90620,
U.S.A.
Tel: 714-522-9011

CENTRAL & SOUTH AMERICA

MEXICO

Yamaha de México, S.A. de C.V.
Av. Insurgentes Sur 1647 Piso 9, Col. San José
Insurgentes, Delegación Benito Juárez, México,
D.F., C.P. 03900
Tel: 55-5804-0600

BRAZIL

Yamaha Musical do Brasil Ltda.
Rua Joaquim Floriano, 913 - 4º andar, Itaim Bibi,
CEP 04534-013 São Paulo, SP. BRAZIL
Tel: 011-3704-1377

ARGENTINA

**Yamaha Music Latin America, S.A.,
Sucursal Argentina**
Olga Cossetini 1553, Piso 4 Norte,
Madero Este-C1107CEK
Buenos Aires, Argentina
Tel: 011-4119-7000

VENEZUELA

**Yamaha Music Latin America, S.A.,
Sucursal Venezuela**
C.C. Manzanares Plaza P4
Ofic. 0401- Manzanares-Baruta
Caracas Venezuela
Tel: 58-212-943-1877

PANAMA AND OTHER LATIN

AMERICAN COUNTRIES/ CARIBBEAN COUNTRIES

Yamaha Music Latin America, S.A.
Torre Banco General, Piso No.7, Marbella,
Calle 47 y Aquilino de la Guardia,
Ciudad de Panamá, República de Panamá
Tel: +507-269-5311

EUROPE

THE UNITED KINGDOM/IRELAND

Yamaha Music Europe GmbH (UK)
Sherbourne Drive, Tilbrook, Milton Keynes,
MK7 8BL, U.K.
Tel: 01908-366700

GERMANY

Yamaha Music Europe GmbH
Siemensstraße 22-34, 25462 Rellingen, Germany
Tel: 04101-3030

SWITZERLAND/LIECHTENSTEIN

**Yamaha Music Europe GmbH
Branch Switzerland in Zürich**
Seefeldstrasse 94, 8008 Zürich, Switzerland
Tel: 044-387-8080

AUSTRIA/BULGARIA

Yamaha Music Europe GmbH Branch Austria
Schleiergasse 20, A-1100 Wien, Austria
Tel: 01-60203900

CZECH REPUBLIC/HUNGARY/ ROMANIA/SLOVAKIA/SLOVENIA

**Yamaha Music Europe GmbH
Branch Austria (Central Eastern Europe Office)**
Schleiergasse 20, A-1100 Wien, Austria
Tel: 01-60203900

POLAND/LITHUANIA/LATVIA/ESTONIA

**Yamaha Music Europe GmbH
Branch Poland Office**
ul. Wrotkowa 14 02-553 Warsaw, Poland
Tel: 022-500-2925

MALTA

Olimpus Music Ltd.
The Emporium, Level 3, St. Louis Street Msida
MSD06
Tel: 02133-2144

NETHERLANDS/BELGIUM/ LUXEMBOURG

Yamaha Music Europe Branch Benelux
Clarissenhof 5-b, 4133 AB Vianen, Netherlands
Tel: 0347-358 040

FRANCE

Yamaha Music Europe
7 rue Ambroise Croizat, Zone d'activites Pariest,
77183 Croissy-Beaubourg, France
Tel: 01-64-61-4000

ITALY

Yamaha Music Europe GmbH, Branch Italy
Viale Italia 88, 20020 Lainate (Milano), Italy
Tel: 02-935-771

SPAIN/PORTUGAL

**Yamaha Music Europe GmbH Ibérica, Sucursal
en España**
Ctra. de la Coruna km. 17,200, 28231
Las Rozas (Madrid), Spain
Tel: +34-91-639-88-88

GREECE

Philippos Nakas S.A. The Music House
147 Skiathou Street, 112-55 Athens, Greece
Tel: 01-228 2160

SWEDEN/FINLAND/ICELAND

**Yamaha Music Europe GmbH Germany filial
Scandinavia**
J. A. Wettergrensgata 1, Box 30053
S-400 43 Göteborg, Sweden
Tel: +46 31 89 34 00

DENMARK

**Yamaha Music Europe GmbH, Tyskland – filial
Denmark**
Generatorvej 6A, DK-2730 Herlev, Denmark
Tel: 44 92 49 00

NORWAY

**Yamaha Music Europe GmbH Germany -
Norwegian Branch**
Grini Næringspark 1, N-1361 Østerås, Norway
Tel: 67 16 78 00

RUSSIA

Yamaha Music (Russia) LLC.
Room 37, bld. 7, Kievskaya street, Moscow,
121059, Russia
Tel: 495 626 5005

OTHER EUROPEAN COUNTRIES

Yamaha Music Europe GmbH
Siemensstraße 22-34, 25462 Rellingen, Germany
Tel: +49-4101-3030

AFRICA

Yamaha Music Gulf FZE
Office JAFZA 16-512, P.O.Box 17328,
Jebel Ali - Dubai, UAE
Tel: +971-4-881-5868

MIDDLE EAST

TURKEY

Yamaha Music Europe GmbH
Merkezi Almanya Türkiye İstanbul Şubesi
Maslak Meydan Sokak No:5 Spring Giz Plaza
Bağımsız Böl. No:3, 34398 Şişli İstanbul
Tel: +90-212-999-8010

CYPRUS

Yamaha Music Europe GmbH
Siemensstraße 22-34, 25462 Rellingen, Germany
Tel: 04101-3030

OTHER COUNTRIES

Yamaha Music Gulf FZE
Office JAFZA 16-512, P.O.Box 17328,
Jebel Ali - Dubai, U.A.E
Tel: +971-4-881-5868

ASIA

THE PEOPLE'S REPUBLIC OF CHINA

Yamaha Music & Electronics (China) Co.,Ltd.
2F, Yunhedasha, 1818 Xinzha-lu, Jingan-qu,
Shanghai, China
Tel: 021-6247-2211

INDIA

Yamaha Music India Pvt. Ltd.
Spazedge building, Ground Floor, Tower A, Sector
47, Gurgaon- Sohna Road, Gurgaon, Haryana, India
Tel: 0124-485-3300

INDONESIA

PT. Yamaha Musik Indonesia (Distributor)
Yamaha Music Center Bldg. Jalan Jend. Gatot
Subroto Kav. 4, Jakarta 12930, Indonesia
Tel: 021-520-2577

KOREA

Yamaha Music Korea Ltd.
8F, 9F, Dongsung Bldg. 158-9 Samsung-Dong,
Kangnam-Gu, Seoul, Korea
Tel: 02-3467-3300

MALAYSIA

Yamaha Music (Malaysia) Sdn., Bhd.
No.8, Jalan Perbandaran, Kelana Jaya, 47301
Petaling Jaya, Selangor, Malaysia
Tel: 03-78030900

SINGAPORE

Yamaha Music (Asia) Private Limited
Block 202 Hougang Street 21, #02-00,
Singapore 530202, Singapore
Tel: 65-6747-4374

TAIWAN

Yamaha Music & Electronics Taiwan Co.,Ltd.
3F, No.6, Section 2 Nan-Jing East Road, Taipei,
Taiwan R.O.C.
Tel: 02-2511-8688

THAILAND

Siam Music Yamaha Co., Ltd.
3, 4, 15 and 16th floor, Siam Motors Building,
891/1 Rama 1 Road, Wangmai,
Pathumwan, Bangkok 10330, Thailand
Tel: 02-215-2622

VIETNAM

Yamaha Music Vietnam Company Limited
15th Floor, Nam A Bank Tower, 201-203 Cach
Mang Thang Tam St., Ward 4, Dist.3,
Ho Chi Minh City, Vietnam
Tel: +84-8-3818-1122

OTHER ASIAN COUNTRIES

**Yamaha Corporation
Sales & Marketing Division**
Nakazawa-cho 10-1, Naka-ku, Hamamatsu,
Japan 430-8650
Tel: +81-53-460-2312

OCEANIA

AUSTRALIA

Yamaha Music Australia Pty. Ltd.
Level 1, 99 Queensbridge Street, Southbank,
Victoria 3006, Australia
Tel: 3-9693-5111

COUNTRIES AND TRUST

TERRITORIES IN PACIFIC OCEAN

**Yamaha Corporation
Sales & Marketing Division**
Nakazawa-cho 10-1, Naka-ku, Hamamatsu,
Japan 430-8650
Tel: +81-53-460-2312



Yamaha Pro Audio global web site
<http://www.yamahaproaudio.com/>

Yamaha Manual Library
<http://www.yamaha.co.jp/manual/>

C.S.G., PA Development Division
© 2013 Yamaha Corporation

310YJHD-B0
Printed in China

ZG06180