

YAMAHA DSP-A500

Natural Sound Digital Sound Field Processing Amplifier

Ampli-processeur de champ sonore numérique de la série "Natural Sound"

Natural Sound-Klangfeldverstärker

Förstärkare för digital ljudfältbehandling med naturligt ljud

Amplificatore digitale a suono naturale per l'elaborazione del campo sonoro

Amplificador de procesamiento de campo de sonido digital de Sonido natural

CENTER

**OWNER'S MANUAL
MODE D'EMPLOI
BEDIENUNGSANLEITUNG
BRUKSANVISNING
MANUALE DELL'UTENTE
MANUAL DE INSTRUCCIONES**

SUPPLIED ACCESSORIES
ACCESSOIRES FOURNIS
MITGELIEFERTE ZUBEHÖRTEILE
MEDFÖLJANDE TILLBEHÖR
ACCESSORI IN DOTAZIONE
ACCESORIOS INCLUIDOS

- After unpacking, check that the following parts are contained.
- Après le déballage, vérifiez que les pièces suivantes sont incluses.
- Nach dem Auspacken überprüfen, ob die folgenden Teile vorhanden sind.
- Kontrollera efter det apparaten packats upp att följande delar finns med.
- Disimballato l'apparecchio, controllate di possedere tutte le parti menzionate.
- Desembale el aparato y verifique que los siguientes accesorios están en la caja.

- Remote Control Transmitter
- Emetteur de télécommande
- Fernbedienungsgeber
- Fjärrkontrollsändare
- Trasmittente del telecomando
- Transmisor del control remoto

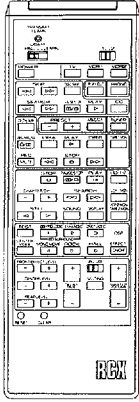

- Batteries (size AA, LR6, AM-3)
- Piles (taille AA, LR6, AM-3)
- Batterien (gröÖ AA, LR6, AM-3)
- Batterier (storlek AA, LR6, AM-3)
- Batterie (taglia AA, LR6, AM-3)
- Pilas (tamaño AA, LR6, AM-3)

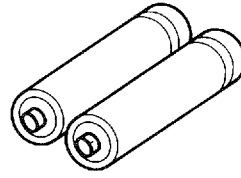

- User Program Sheets
- Feuilles de programmation
- Beschriftungsfolien
- Programblad
- Fogli di adesivi per la programmazione
- Cubiertas di programa

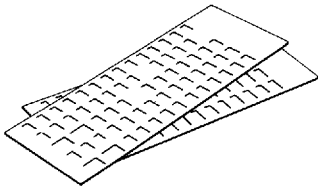

This product complies with the radio frequency interference requirements of the Council Directive 82/499/EEC and/or 87/308/EEC.

Cet appareil est conforme aux prescriptions de la directive communautaire 87/308/CEE.

Diese Geräte entsprechen der EG-Richtlinie 82/499/EWG und/oder 87/308/EWG.

Detta apparat överholder det gældende EF-direktiv vedrørende radiostøj.

Questo apparecchio è conforme al D.M.13 aprile 1989 (Direttiva CEE/87/308) sulla soppressione dei radiodisturbi.

Este producto está de acuerdo con los requisitos sobre interferencias de radio frecuencia fijados por el Consejo Directivo 87/308 CEE.

Dit product voldoet aan de EEG normen betreffende radio-frekventie storingen 82/499/EEG en/of 87/308/EEG.

FEATURES

- **5 Speaker Configuration**
Front: (General model)
 65W + 65W (8Ω) RMS Output Power, 0.03% THD,
 20–20,000 Hz
(Australia, Europe and U.K. models)
 60W + 60W (8Ω) RMS Output Power, 0.03% THD,
 20–20,000 Hz
Center: 25W (8Ω) RMS Output Power, 0.08% THD,
 20–20,000 Hz
Rear: 25W + 25W (8Ω) RMS Output Power, 0.3%THD, 1,000 Hz
- **Digital Sound Field Processor**
 4 Programs for Digital Sound Field Processing
 2 Programs for Dolby Surround (DOLBY PRO LOGIC
 and ENHANCED)
- **Automatic Input Balance Control for Dolby Surround**
- **Video Signal Input/Output Capability**
- **Programmable Remote Control Transmitter**

CONTENTS

Supplied Accessories	2
Features	3
Contents	3
Caution	3
Profile of This Unit	4
Speaker Setting-up for This Unit	5
Connections	6
Adjustment Before Operation	8
Operations	11
Using Digital Sound Field Processor (DSP)	14
Remote Control Transmitter	18
Remote Control "Learning" Function	19
Notes about the Remote Control Transmitter	20
Troubleshooting	21
Specifications	22

CAUTION: READ THIS BEFORE OPERATING YOUR UNIT.

1. To assure the finest performance, please read this manual carefully. Keep it in a safe place for future reference.
2. Install this unit in a cool, dry, clean place – away from windows, heat sources, sources of excessive vibration, dust, moisture and cold. Avoid sources of humming (transformers, motors). To prevent fire or electrical shock, do not expose the unit to rain or water.
3. Never open the cabinet. If something drops into the set, contact your dealer.
4. Do not use force on switches, controls or connection wires. When moving the unit, first disconnect the power plug and the wires connected to other equipment. Never pull the wire itself.
5. The openings on the cabinet assure proper ventilation of the unit. If these openings are obstructed, the temperature inside the cabinet will rise rapidly and eventually damage the circuits. Therefore, avoid placing objects against these openings and do not install the unit where the flow of air through the ventilation openings could be impeded.
6. Always set the VOLUME control to "– ∞ " before starting the audio source play; increase the volume gradually to an appropriate level after the play has been started.
7. Do not attempt to clean the unit with chemical solvents; this might damage the finish. Use a clean, dry cloth.
8. Be sure to read the "TROUBLESHOOTING" section regarding common operating errors before concluding that the unit is faulty.
9. When not planning to use this unit for long periods of time (ie., vacation, etc.), disconnect the AC power plug from the wall outlet.
10. To prevent lightning damage, disconnect the AC power plug and disconnect the antenna cable when there is an electrical storm.
11. Grounding or polarization – Precautions should be taken so that the grounding or polarization of an appliance is not defeated.
12. AC outlet
Do not connect audio equipment to the AC outlet on the rear panel if that equipment requires more power than the outlet is rated to provide.
13. **Voltage Selector (General Model only)**
The voltage selector on the rear panel of this unit must be set for your local main voltage BEFORE plugging into the AC main supply.
Voltages are 110/120/220/240 V AC, 50/60 Hz.

IMPORTANT

Please record the serial number of this unit in the space below.

Serial No.:

The serial number is located on the rear of the unit. Retain this Owner's Manual in a safe place for future reference.

WARNING

TO REDUCE THE RISK OF FIRE OR ELECTRIC SHOCK, DO NOT EXPOSE THIS UNIT TO RAIN OR MOISTURE.

CAUTION (FOR CANADA MODEL)

TO PREVENT ELECTRIC SHOCK DO NOT USE THIS (POLARIZED) PLUG WITH AN EXTENSION CORD RECEPTACLE OR OTHER OUTLET UNLESS THE BLADES CAN BE FULLY INSERTED TO PREVENT BLADE EXPOSURE.

FOR CANADIAN CUSTOMER

THIS DIGITAL APPARATUS DOES NOT EXCEED THE "CLASS B" LIMITS FOR RADIO NOISE EMISSIONS FROM DIGITAL APPARATUS SET OUT IN THE RADIO INTERFERENCE REGULATION OF THE CANADIAN DEPARTMENT OF COMMUNICATIONS.

CAUTION

The power switch does not disconnect the complete apparatus from the mains line.

Special Instructions for U.K. Model

IMPORTANT

THE WIRES IN THE MAINS LEAD ARE COLOURED IN ACCORDANCE WITH THE FOLLOWING CODE:

Blue: NEUTRAL
Brown: LIVE

As the colours of the wires in the mains lead of this apparatus may not correspond with the coloured markings identifying the terminals in your plug, proceed as follows:
The wire which is coloured BLUE must be connected to the terminal which is marked with the letter N or coloured BLACK. The wire which is coloured BROWN must be connected to the terminal which is marked with the letter L or coloured RED. Making sure that neither core is connected to the earth terminal of the three pin plug.

PROFILE OF THIS UNIT

You are the proud owner of Yamaha DSP-A500, the stereo amplifier—an extremely sophisticated audio component. The Digital Sound Field Processor (DSP) built in this unit takes full advantage of Yamaha's undisputed leadership in the field of digital audio processing to bring you a whole new world of listening experiences. Follow the instructions in this manual carefully when setting up your system, and this unit will sonically transform your room into a wide range of listening environments—movie theater, concert hall, and so on. In addition, you get incredible realism from Dolby-encoded video sources using the built-in Dolby Pro Logic Surround Decoder.

Rather than tell you about the wonders of digital sound field processing, however, let's get right down to the business of setting up the system and trying out its many capabilities. Please read this operation manual carefully and store it in a safe place for later reference.

Digital Sound Field Processing

What is it that makes live music so good? Today's advanced sound reproduction technology lets you get extremely close to the sound of a live performance, but chances are you'll still notice something missing: the acoustic environment of the live concert hall. Extensive research into the exact nature of the sonic reflections that create the ambience of a large hall has made it possible for Yamaha engineers to bring you this same sound in your own listening room, so you'll feel all the sound of a live concert.

What's more, our technicians, armed with sophisticated measuring equipment, have even made it possible to capture the acoustics of a variety of actual concert hall, theater, etc. to allow you to accurately recreate one of several actual live performance environments, all in your own home.

Dolby Pro Logic Surround

The Dolby Pro Logic Surround Decoder program lets you experience the dramatic realism and impact of Dolby Surround movie theater sound in your own home. Dolby Pro Logic gets its name from its professional-grade steering logic circuitry, which provides greater effective channel separation for a much higher degree of realism than the "passive" Dolby Surround circuits found in today's typical home audio/video equipment. Dolby Pro Logic Surround provides a true center channel, so that there are four independent channels, unlike passive Dolby Surround which has in effect only three channels: left, right, and rear. This center channel allows listeners seated in even less-than-ideal positions to hear the dialog originating from action on the screen while getting a stereo effect as well.

This Dolby Pro Logic Surround Decoder employs a digital signal processing system. This system increases sound stability at each channel and minimizes crosstalk between channels, compared to conventional analog Dolby signal processing.

In addition, this unit features a built-in automatic input balance control. This circuit always presents you the best surround conditions without performing manual adjustments.

"ENHANCED" Dolby Pro Logic Surround

The DSP-A500 has a second mode of Dolby Pro Logic Surround processing called "Enhanced Dolby Pro Logic Surround" processing. Enhanced Dolby Pro Logic Surround processing recreates the surround effect of a movie theater, effectively duplicating their multiple surround loudspeaker system, completely surrounding the listener with the sounds of the action taking place on the screen.

SPEAKER SETTING UP FOR THIS UNIT

SPEAKERS TO BE USED

This unit is designed to provide the best sound-field quality with 5 speaker configuration. The speakers to be used with this unit will be mainly front speakers, rear speakers, and a center speaker. (You can delete a center speaker. Refer to the "4-Speaker Configuration" shown below.)

The front speakers are used for the output of the main source sound and the effect sound. They will probably be your present stereo speaker system. The rear speakers are used for the output of the effect sound. And the center speaker is used for the output of the center sound (dialogue etc.) encoded with the Dolby Surround. The rear and center speakers do not need to be equal with the front speakers. However, all the speakers should have high enough power handling to accept the maximum output of this unit that will drive them.

SPEAKER CONFIGURATION

5-Speaker Configuration

This configuration is the most effective and recommended. In this configuration, the center speaker is necessary as well as the rear speakers. If the digital sound field program is in the **DOLBY PRO LOGIC** or **ENHANCED**, conversations will be output from the center speaker and the ambience will be excellent.

- Set the center mode to the "NORMAL" or "WIDE" position. (For details, refer to the page 9.)

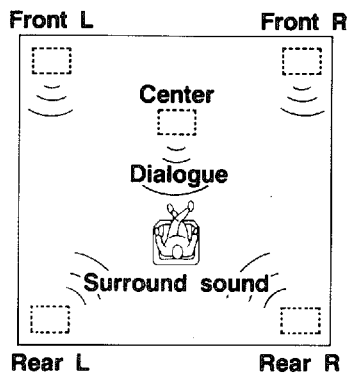

4-Speaker Configuration

The center speaker is not used in this configuration. If the digital sound field program is in the **DOLBY PRO LOGIC** or **ENHANCED**, the center sound is output from the left and the right front speakers. However, the sound effect of other programs can be the same as that of the 5-speaker configuration.

- Be sure to set the center mode to the "PHANTOM" position. (For details, refer to the page 9.)

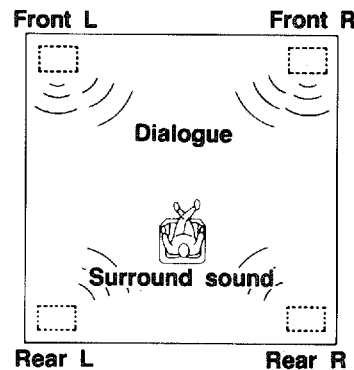

SPEAKER PLACEMENT

The recommended speaker configuration, the 5-speaker configuration, will require two speaker pairs: **front speakers** (your normal stereo speakers), and **rear speakers**, plus a **center speaker**. When you place these speakers, refer to the following.

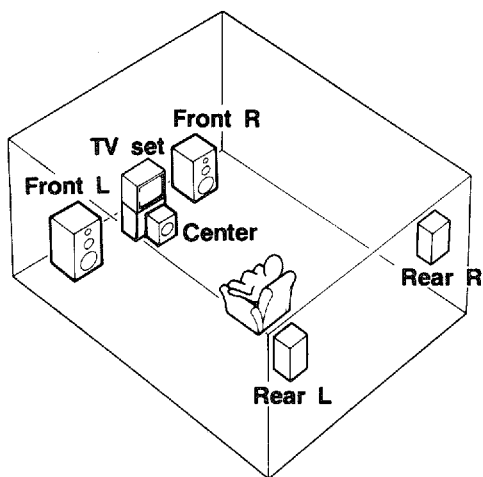

- Front:** In normal position. (The position of your present stereo speaker system.)
- Rear:** Behind your listening position, facing slightly inward. Nearly six feet up from the floor.
- Center:** Precisely between the front speakers. (To avoid interference to TV sets, use a magnetically shielded speaker. If, however, it is not effective, keep the speaker away from TV sets.)

CONNECTIONS

Before attempting to make any connections to or from this unit, be sure to first switch OFF the power to this unit and to any other components to which connections are being made.

CONNECTIONS WITH OTHER COMPONENTS

When making connections between this unit and other components, be sure all connections are made correctly, that is to say L (left) to L, R (right) to R, "+" to "+" and "-" to "-". Also, refer to the owner's manual for each component to be connected to this unit.

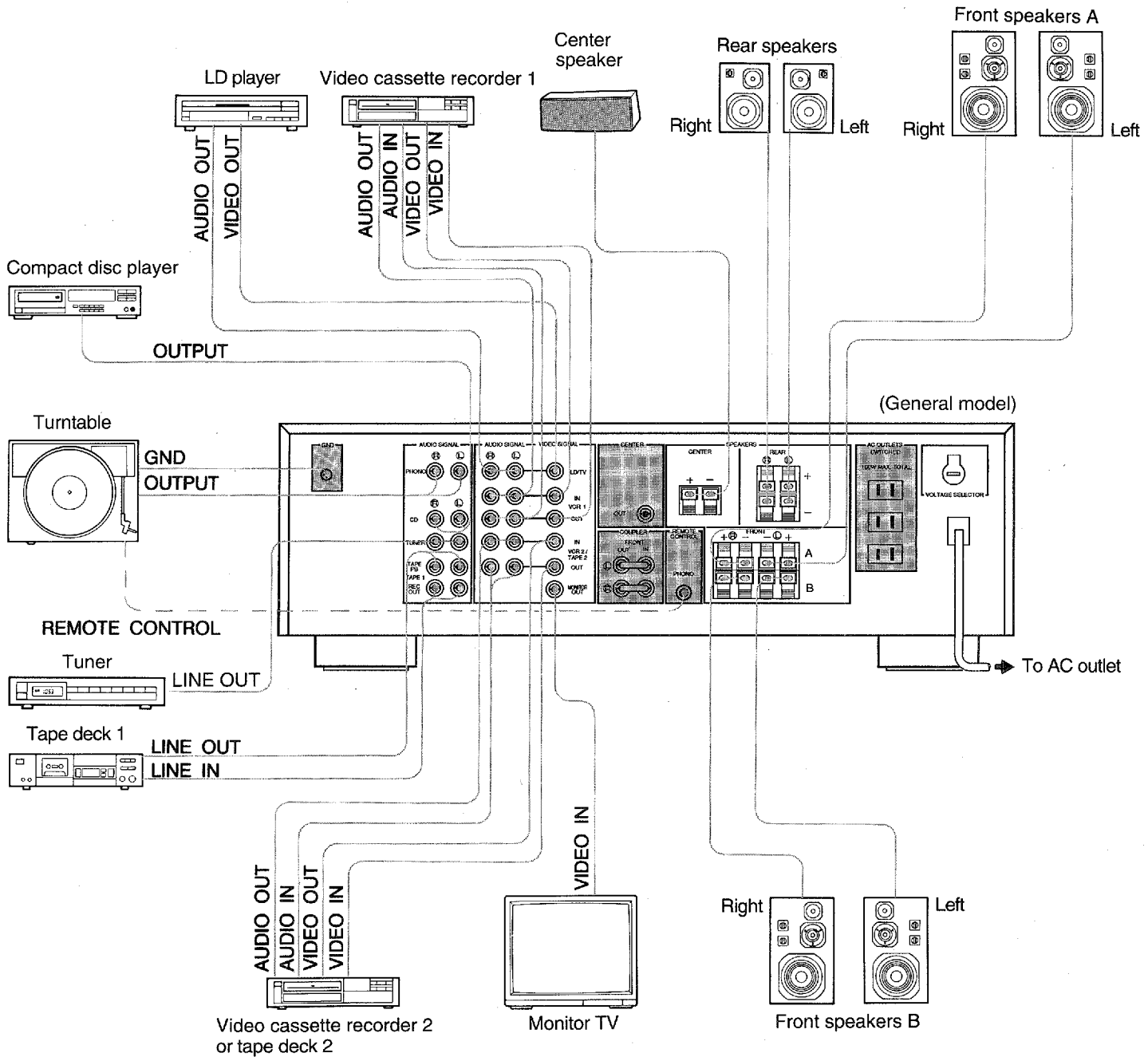

 : Refer to "About the ACCESSORY terminals" on the page 7.

CONNECTING SPEAKERS

Connect the **SPEAKERS** terminals to your speakers with wire of the proper gauge, cut to be as short as possible. If the connections are faulty, no sound will be heard from the speakers. Make sure that the polarity of the speaker wires is correct, that is, + and – markings are observed. If these wires are reversed, the sound will be unnatural and will lack bass.

Do not let the bare speaker wires touch each other and do not let them touch the metal parts of this unit as this could damage this unit and/or speakers.

- Use speakers with the specified impedance shown on the rear of this unit.

How to Connect:

Red: positive (+)
Black: negative (–)

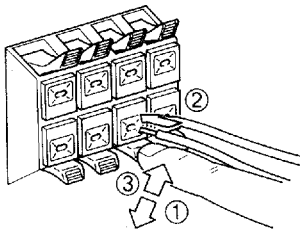

- ① Press and hold the tab.
- ② Insert the bare wire.
[Remove approx. 5mm (1/4") insulation from the speaker wires.]
- ③ Release the tab and secure the wire.

Note for front speaker connection:

One or two speaker systems can be connected to this unit. If you connect only one speaker system, connect it to either the **FRONT A** or **B** terminals.

ABOUT THE ACCESSORY TERMINALS

AC OUTLETS

(Europe and General models)

.....3 SWITCHED OUTLETS

(Australia and U.K. models)

..... 1 SWITCHED OUTLET

Use these to connect the power cords from your components to this unit.

The power to the **SWITCHED** outlets is controlled by this unit's **POWER** switch or the provided remote-control transmitter's **POWER** key. These outlets will supply power to any component whenever this unit is turned on.

The maximum power (total power consumption of components) that can be connected to the **SWITCHED AC OUTLETS** is 100 watts.

REMOTE CONTROL (PHONO) connector

If you have a YAMAHA turntable with the  mark, connect it to this connector by using the cable provided with the turntable. This connection allows you to control the turntable from the provided remote control transmitter.

GND terminal (For turntable use)

Connecting the ground wire of the turntable to this terminal will minimize hum, but in some cases better results may be obtained with the ground wire disconnected.

FRONT OUT terminals

These terminals are for front-channel line output. Leave the jumper bars connected to **FRONT IN** terminals when you use the built-in amplifier.

However, if you drive front speakers with an external stereo power amplifier, remove the jumper bars and connect input terminals of the external amplifier (MAIN IN or AUX terminals of a power amplifier or an integrated amplifier) to these terminals.

FRONT IN terminals

These terminals are for line input to the built-in front-channel amplifier. Leave the jumper bars connected to **FRONT OUT** terminals when you use the built-in amplifier.

However, if you drive front speakers with an external stereo power amplifier, remove the jumper bars.

CENTER OUT terminal

This terminal is for center-channel line output. There is no connection to this terminal when you use the built-in amplifier. However, if you drive a center speaker with an external power amplifier, connect input terminal of the external amplifier to this terminal.

If you use the built-in amplifier and the external power amplifier at the same time, the sound will be output through both speakers.

ADJUSTMENT BEFORE OPERATION

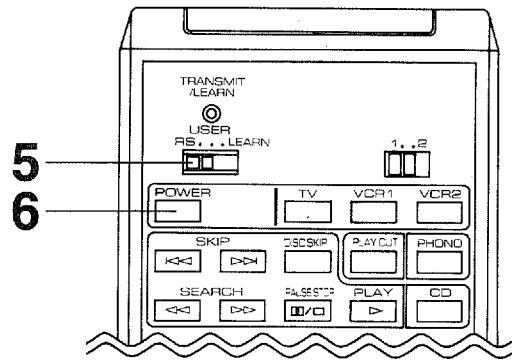
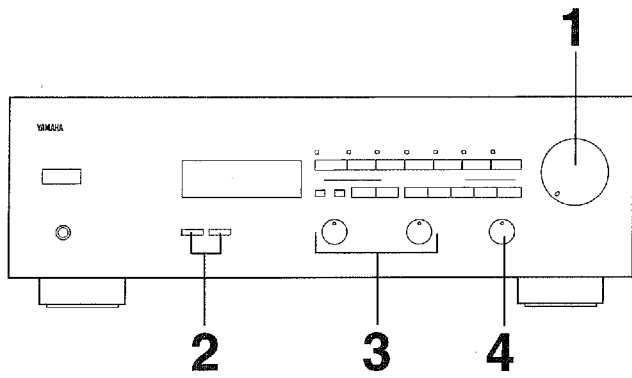

Speaker balance adjustment

Using the built-in test tone generator, this procedure lets you adjust the sound output level balance between the front, center, and rear speakers. With this adjustment, the sound output level heard at the listening position will be the same from each speaker. This is important for the best performance of digital sound field processor.

<p>1</p>	<p>VOLUME</p> <p>Set to the "∞" position.</p>
<p>2</p>	<p>SPEAKERS</p> <p>A B</p> <p>ON ON</p> <p>OFF OFF</p> <p>* If you use two front speaker systems, press both the A and B switches.</p>
<p>3</p>	<p>BASS TREBLE</p> <p>Set to the "0" position.</p>
<p>4</p>	<p>BALANCE</p> <p>Set to the "0" position.</p>

From the step 5, the adjustment should be done with the remote control transmitter at your listening position. (The adjustment can be done also with the controllers on the front panel of this unit. However, the result may not be as satisfactory as from your listening position.)

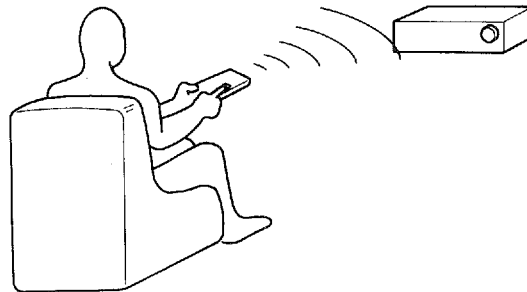

<p>5</p>	<p>USER RS . . . LEARN</p> <p>Set to the "RS" position.</p>
<p>6</p>	<p>POWER</p>

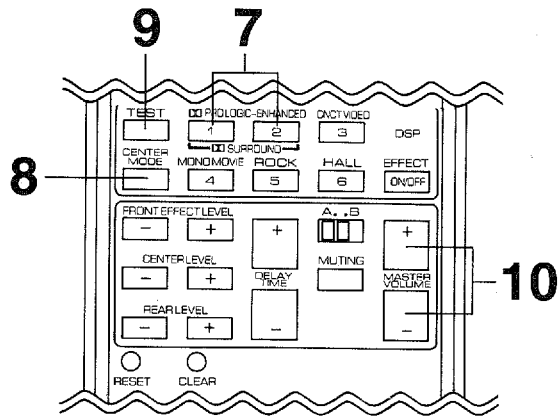

For the detailed information on the remote control transmitter, refer to "REMOTE CONTROL TRANSMITTER" on the page 23.

7

or

8 Select the center mode depending on your speaker configuration. (Refer to "SPEAKER CONFIGURATION" on page 5.)

* On the feature of each mode, refer to the "Note" shown below.

9

Flashes on and off continuously.

10 Turn up the volume by using the remote-control transmitter. You will hear a test tone (like pink noise) from the left front speaker, then the center speaker, then the right front speaker, then the rear speakers, for about two seconds each. The display illumination changes as shown below.

* The test tone from the left rear speaker and the right rear speaker will be heard at the same time.

Note

In the step 8, when you select the center mode, note the following.

For 5 speaker configuration

NORMAL: Select this mode when you use the center speaker smaller sized than the front speakers. In this mode, the bass tone will be output from the front speakers.

WIDE: Select this mode when you use the center speaker approximately same sized as the front speakers.

For 4 speaker configuration

PHANTOM: Select this mode when you do not use the center speaker. The center sound will be output from the left and the right front speakers.

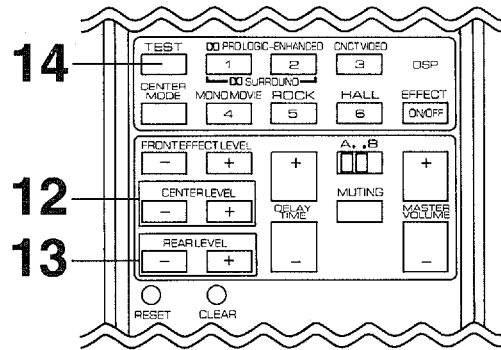
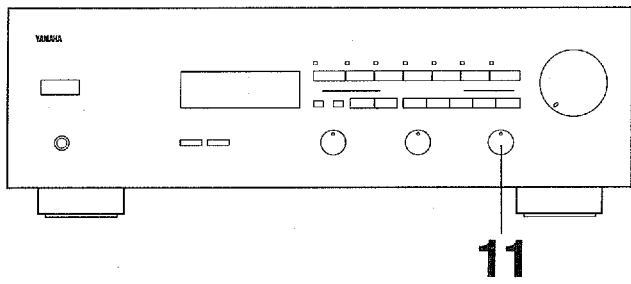

11 Adjust the **BALANCE** control so that the effect sound output level of the left front speaker and the right front speaker are the same.

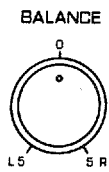

On the front panel of the unit.

12 Make the sound output level of the center speaker the same as that of the front speakers with the **CENTER LEVEL** key.

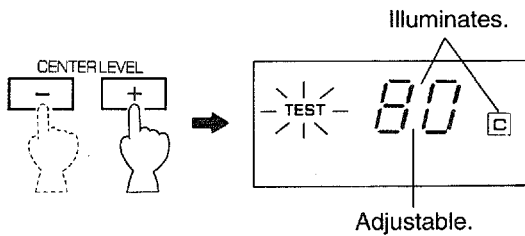

13 Make the sound output level of the rear speakers the same as that of the front speakers with the **REAR LEVEL** key.

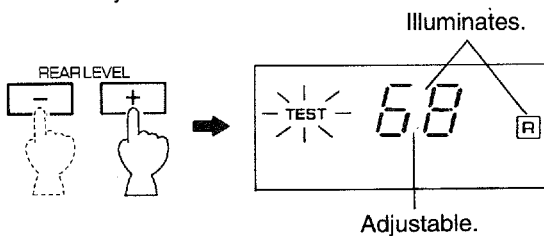

14

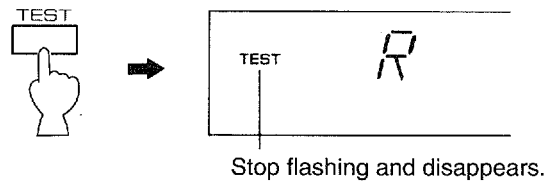

Notes

- Once you have completed these adjustments, use only this unit's **VOLUME** control to adjust listening volume. Do not change any other volume settings in this unit.
- If you use external power amplifiers, their volume controls may also be adjusted to achieve proper balance.
- In the step 12, if the center mode is in the "PHANTOM", the sound output level of the center speaker can not be adjusted. Because in this mode, the center sound is automatically output from the left and right front speakers.

OPERATIONS

ENGLISH

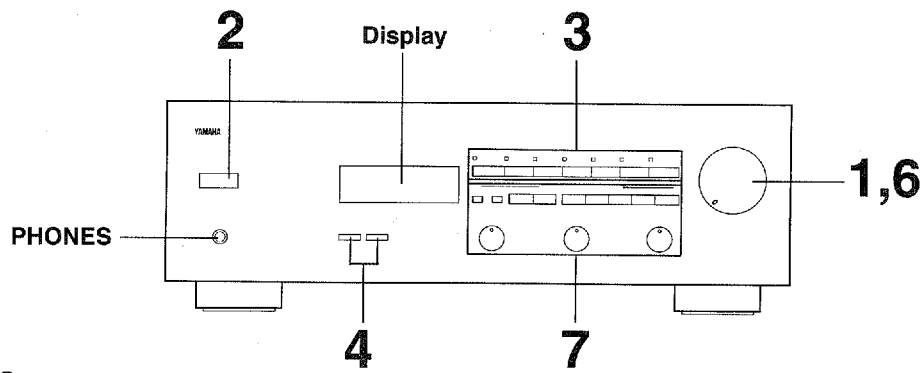

To play a source

1

VOLUME

Set to the "∞" position.

2

POWER

3 Select a desired input source.
(For video sources, turn the TV/monitor ON.)

VCR 2 MON /
 TAPE 2 MON
 VCR 1 MON
 LD/TV
 TAPE 1 MON
 TUNER
 CD
 PHONO

* The indicator corresponding to the selected input source will illuminate.

4 Select the front speakers to be used.

SPEAKERS

A		B	
ON	▲	ON	▲
OFF	▲	OFF	▲

* If you use two front speaker systems, press both the A and B switches.

5 Play the source.

6

VOLUME

Adjust to the desired output level.

7 If desired, adjust the **BASS, TREBLE, BALANCE** controls, etc. (Refer to page 13.) and use the digital sound field processor. (Refer to page 14.)

Notes

In the step 3, if two or more program sources are selected at the same time (by using input selectors), be sure to remember the priority order of the input sources.

Priority order of audio sources: 1) **TAPE 1 MON**, 2) **VCR 1 MON**, 3) **VCR 2 MON/TAPE 2 MON**, and 4) **LD/TV, TUNER, CD** or **PHONO**.

Priority order of video sources: 1) **VCR 1 MON**, 2) **VCR 2 MON/TAPE 2 MON**, and 3) **LD/TV**.

- If you select **LD/TV, TUNER, CD** or **PHONO**, be sure that **TAPE MON** and/or **VCR MON** input selectors are not being selected.
- If you select **TAPE 1 MON** and **VCR 1 (or 2) MON** input selectors at the same time, the result will be the visual of the VCR and the sound from the audio tape.
- If you select both **LD/TV** and **TAPE MON** input selectors at the same time, the result will be the visual of the LD player and the sound from the audio tape.
- Once you play the LD player, its visual will not be interrupted even if other input selectors except **VCR MON** input selectors are selected.
- If you select **TAPE 1 MON** and **VCR 1 (or 2) MON** input selectors, and another input selector at the same time, the result will be the visual of the VCR and the sound from the audio tape.

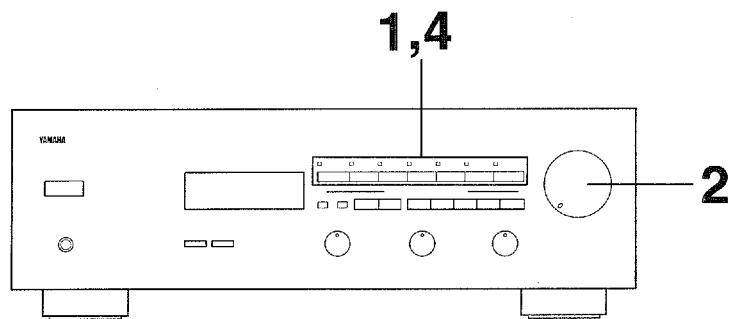

To record a source to tape

1 Select the source to be recorded.

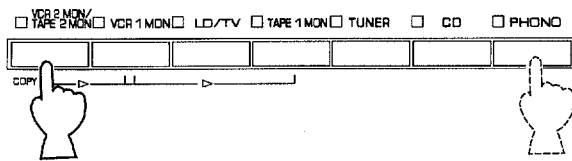

- * To dub from tape to tape, refer to the "Notes" shown below.
- * When selecting **LD/TV**, **TUNER**, **CD** or **PHONO**, be sure the **TAPE 1 MON**, **VCR 1 MON** or **VCR 2/TAPE 2 MON** input selector(s) are not also selected.

2 Play the source and then turn the **VOLUME** control up to confirm the input source.

3 Set the tape deck or VCR in the recording mode.

4 To monitor the audio and/or video signals being recorded, press the input selector button for the audio or video tape recorder being used to make the recording.

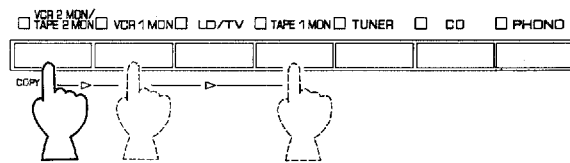

- * A red selector switch indicator takes priority over an orange indicator.

Notes

- There are three ways to dub from tape to tape:
 - 1) To record from VCR 2 or tapedeck 2 to VCR 1, press both the **VCR 2 MON/TAPE 2 MON** and **VCR 1 MON** selector switches (so both the indicators are lighted red).
 - 2) To record from VCR 2 or tapedeck 2 to tapedeck 1, press both the **VCR 2 MON/TAPE 2 MON** and **TAPE 1 MON** selector switches (so both the indicators are lighted red).
 - 3) To record from VCR 1 to tapedeck 1, press both the **VCR 1 MON** and **TAPE 1 MON** selector switches (so both the indicators are lighted red).
- **DSP**, **VOLUME**, **BASS**, **TREBLE** and **BALANCE** control settings have no effect on the material being recorded.

Adjusting the BALANCE control

Adjust the balance of the output volume to the left and right speakers to compensate for sound imbalance caused from speaker location or listening room conditions.

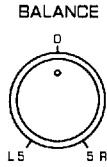

Note
This control is effective only on the sound from the front speakers.

Selecting the SPEAKER system

Because one or two speaker systems (as front speakers) can be connected to this unit, the **SPEAKERS** switches allow you to select speaker system A or B, or both at once.

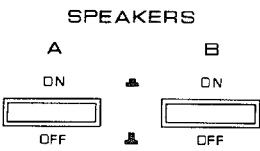

Adjusting the BASS and TREBLE controls

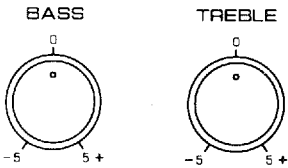

BASS : Turn this clockwise to increase (or counter-clockwise to decrease) the low frequency response.

TREBLE : Turn this clockwise to increase (or counter-clockwise to decrease) the high frequency response.

Note
These controls are effective only on the sound from the front speakers.

When you listen with headphones

Connect the headphones to the **PHONES** jack. You can listen to the main sound through headphones. When listening with headphones privately, set both the **SPEAKERS A** and **B** switches to the **OFF** position.

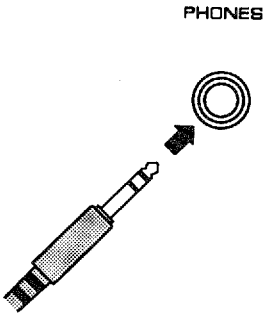

USING DIGITAL SOUND FIELD PROCESSOR (DSP)

This unit incorporates a sophisticated, multi-program digital sound field processor, which allows you to expand and shape the audio sound field from both the audio and video sources, for a theater-like experience in the listening/viewing room.

This digital sound field processor has 6 programs; 4 programs for digital sound field processing and 2 programs for the Dolby Pro Logic Surround sound system (**DOLBY PRO LOGIC** and **ENHANCED**). You can create excellent audio sound field by selecting the suitable program and adding desired adjustments. In addition, when the digital sound field program is in the **DOLBY PRO LOGIC** or **ENHANCED**, the built-in automatic input balance control functions. This presents you the best surround condition without adjusting it manually.

On the front panel of this unit

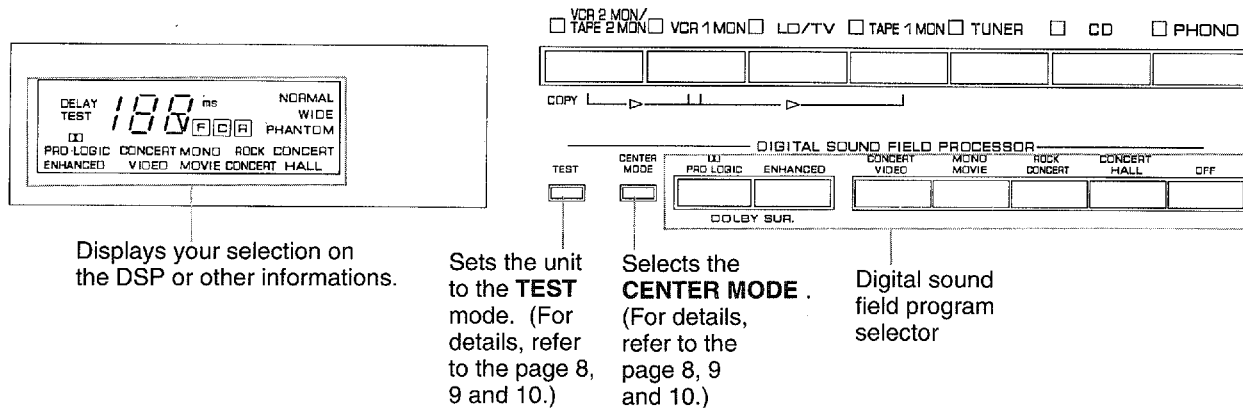

On the remote control transmitter

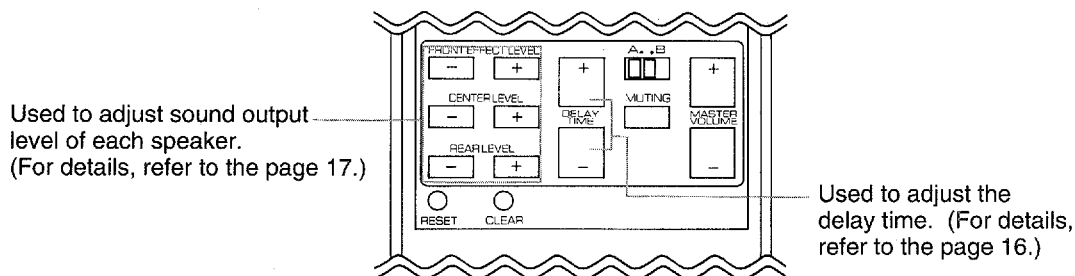

Description of Each Sound Field Program

PROGRAM	FEATURE
<input checked="" type="checkbox"/> PRO LOGIC	This program is effective on the play of the sources encoded with the Dolby Surround. The employment of the digital signal processing system improves crosstalk and transfers the sound source more smoothly and precisely, comparing with the conventional type. A stable movie sound field is recreated.
ENHANCED	This program is effective on the play of the sources encoded with the Dolby Surround. Enhancing the "Normal" Dolby Pro Logic, the DSP technology simulates the multi-surround speaker systems of the 35 mm film theater, so widening the surrounded-sound field with greater presence.
CONCERT VIDEO	This program is effective on music videos and excellent in depth and clarity for vocals. For opera, the orchestra and stage are ideally recreated, so letting you feel as if you were in an actual concert hall.
MONO MOVIE	This program is designed specifically to enhance mono source programs. Compared to a strictly mono setting, the sound image created in this mode is wider and slightly forward of the speaker pair, lending an immediacy to the overall sound. It is particularly effective when used with old mono movies, news broadcasts and dialogue.
ROCK CONCERT	This program will suit to rock music. A big, powerful sound is reproduced lively and dynamically.
CONCERT HALL	In this program, the center seems even more deeply behind the front speaker pair, creating an expansive, large hall ambience.

OFF Switch : When any program is not used with the selected source, press this switch. The sound is output only from the front speakers.

Notes on Operation of Sound Field Programs

- In the **CONCERT VIDEO, MONO MOVIE, ROCK CONCERT** and **CONCERT HALL**, no sound is heard from the center speaker.
- When the monaural sound source is played in the **DOLBY PRO LOGIC** or **ENHANCED**, no sound is heard from the front speakers and the rear speakers. Sound is heard only from the center speaker. However, if the center mode is in the **PHANTOM**, the front speakers output the sound of the center speaker.
- If you connect an external amplifier to this unit, see if it has a built-in surround sound or ambience circuitry. If it does, then be sure that the surround or ambience circuitry on that amplifier is off while you are using the digital sound field processor's Dolby Pro Logic Surround decoding function.
- When this unit is in the Dolby Pro Logic Surround mode, if the main-source sound is considerably altered by overadjustment of the **BASS** or **TREBLE** controls, the relationship with the center and rear channels may produce an unnatural effect.

Description of Dolby Pro Logic Surround

 **DOLBY PRO LOGIC SURROUND:** This unit employs the Dolby Pro Logic Surround system. This system is similar to professional Dolby Stereo decoders used in movie theaters. The Dolby Pro Logic Surround system, by employing a four-channel system, divides the input signals into four levels: the left and right main channels, the center channel (to characterize dialogue), and the rear surround-sound channels (to characterize sound effects, background noise and other ambient noise).

Dolby Surround is encoded on the sound track of commercially available video cassettes and video discs as well. When you play a source encoded with Dolby Surround on your home video system, the Dolby Pro Logic Surround mode on this unit decodes the signal and feeds the surround-sound effects. The Dolby Pro Logic Surround mode may not be always effective on video sources not encoded with Dolby Surround.

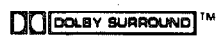

Manufactured under license from Dolby Laboratories Licensing Corporation. Additionally licensed under one or more of the following patents: U.S. numbers 3,632,886, 3,746,792, and 3,959,590; canadian numbers 1,004,603 and 1,037,877. "Dolby" and the double-D symbol are trademarks of Dolby Laboratories Licensing Corporation.

To play source with the digital sound field processor

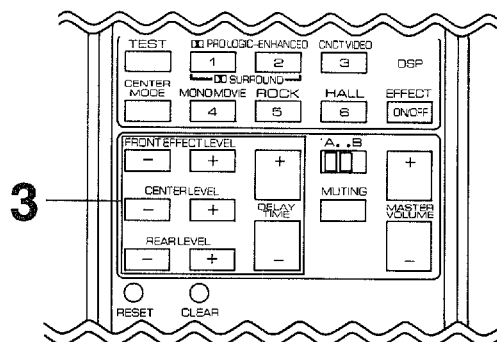
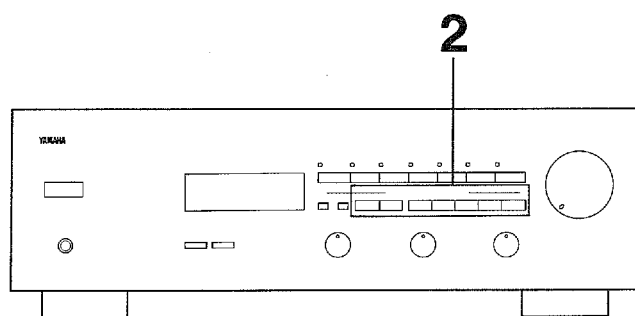

1 Follow the step 1, 2, 3, 4, 5, and 6 shown in "OPERATION" on page 11.

2 Select a desired program suitable for the source.

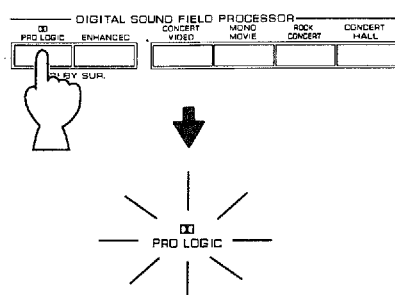

The corresponding indicator will illuminate.

3 If desired, adjust the delay time and the output level of each speaker. (For details, refer to the corresponding descriptions on this page and the next page.)

Note

If you prefer to cancel the selected program, press the **OFF** switch. The sound will be the normal 2-channel stereo without surround sound effect.

Adjustment of DELAY TIME

You can adjust the time difference between the beginning of the source sound and the beginning of the effect sound with the **DELAY TIME** control.

The **DELAY TIME** control is effective with all programs. By applying more or less delay, sound effects, background noise, and ambient noise coming at you from the rear speakers can be enhanced or subdued for extra effect.

- 1 **PRO LOGIC**: from 15 to 30 milliseconds
(Preset value: 20 milliseconds)
- 2 **ENHANCED**: from 15 to 30 milliseconds
(Preset value: 20 milliseconds)
- 3 **CONCERT VIDEO**: from 1 to 100 milliseconds
(Preset value: 25 milliseconds)
- 4 **MONO MOVIE**: from 1 to 100 milliseconds
(Preset value: 25 milliseconds)
- 5 **ROCK CONCERT**: from 1 to 100 milliseconds
(Preset value: 15 milliseconds)
- 6 **CONCERT HALL**: from 1 to 100 milliseconds
(Preset value: 30 milliseconds)

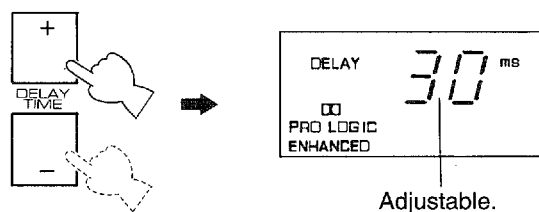

- By continuously pressing "+" or "-" of the **DELAY TIME** control, the value changes continuously. However, the value stops changing momentarily at the preset point.

Note

Adding too much delay will cause an unnatural effect with some sources. Experiment with the **DELAY TIME** control to create an effect that you find most suitable.

Adjustment of the FRONT EFFECT LEVEL

If desired, you can adjust the effect sound output level of the front speakers with this control. The output level is preset to be 80. However, you can adjust the level between 1 and 100.

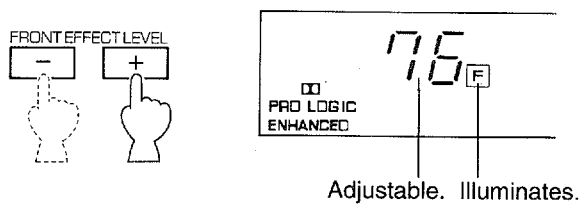

- If the digital sound field program is in the **DOLBY PRO LOGIC**, the **FRONT EFFECT LEVEL** control does not function.
- Once the output level is adjusted, the level value will be common among all the digital sound field programs except the **DOLBY PRO LOGIC**.
- If any digital sound field program is not used, the **FRONT EFFECT LEVEL** control does not function.

Adjustment of the CENTER LEVEL

If desired, you can adjust the sound output level of the center speaker with this control even if the output level is already set in "Speaker balance adjustment" on the page 8.

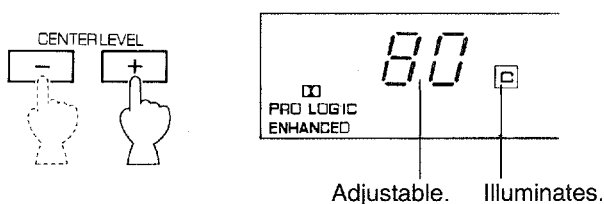

- By continuously pressing "+" or "-" of the **CENTER LEVEL** control, the level value changes continuously. However, the value stops changing momentarily at the point which was once set in the **TEST** mode.
- If the digital sound field program is in the **CONCERT VIDEO, MONO MOVIE, ROCK CONCERT** or **CONCERT HALL**, the **CENTER LEVEL** control can not function.
- Once the output level is adjusted, the level value will be common among the **DOLBY PRO LOGIC** and **ENHANCED**.
- If any digital sound field program is not used, the **CENTER LEVEL** control does not function.

Adjustment of the REAR LEVEL

If desired, you can adjust the sound output level of the rear speakers with this control even if the output level is already set in "Speaker balance adjustment" on the page 8.

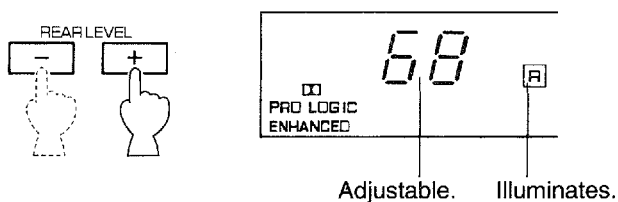

- By continuously pressing "+" or "-" of the **REAR LEVEL** control, the level value changes continuously. However, the value stops changing momentarily at the point which was once set in the **TEST** mode.
- Once the output level is adjusted, the level value will be common among all the digital sound field programs.
- If any digital sound field program is not used, the **REAR LEVEL** control does not function.

Note

The values of the **DELAY TIME**, the **FRONT EFFECT LEVEL**, **CENTER LEVEL**, and **REAR LEVEL** you set the last time will remain memorized even when the power of this unit is off. However, in case the power plug cord is kept disconnected for more than two weeks, these values will be invalid.

REMOTE CONTROL TRANSMITTER

The provided remote control transmitter is designed to control this unit and other YAMAHA components. If the CD player, turntable, LD player and tape deck connected to this unit are YAMAHA components designed for remote control compatibility (components with an *RS* mark), then this remote control transmitter will also control various functions of each component. Please consult YAMAHA dealer for information on which components are compatible with the remote control transmitter. Moreover, this remote control transmitter can learn various functions from other remote control transmitters without losing the preset key functions. If you use this "learning" function, you will no more need so many remote control transmitters to control various components to be used. For details, refer to the next page.

Preset Key Functions

When you operate this unit and/or YAMAHA components with this remote control transmitter, set the **RS-USER-LEARN** switch to the **RS** position.

For Control of This Unit

RS-USER-LEARN switch

- Turns the power on/off.
 - * (Europe model only)
 - Turns the **POWER** on mode to the **STANDBY** mode and vice versa.
 - (In the **STANDBY** mode, the **POWER/STANDBY** indicator is half illuminated.)
- * Refer to "**Speaker balance adjustment**" in "**ADJUSTMENTS BEFORE OPERATION**".
- Selects center speaker mode.
- Adjusts sound output level at each speaker.
- Selects input source.
- Selects a program from the digital sound field processor.
- Switch off digital sound field programs.
- When pressed, mutes the volume level. To resume original volume level, press this again. While muting, the indicator on the **VOLUME** control flashes on and off continuously.
- Turns the volume level up/down.
- Adjusts delay time.

For Other Component Control

Identify the remote control transmitter keys with your component's keys. If these keys are identical, their function will be the same. On each key function, refer to the corresponding instruction on your component's manual.

RS-USER-LEARN switch

- Controls tape deck.
 - * **DIR A, B** and **DECK A/B** are applicable only to double cassette tape deck.
- * Refer to "Blank keys" on the next page.
- Starts/stops record play on turntable.
- Controls compact disc player.
 - * **DISC SKIP** is applicable only to compact disc auto changer.
- Selects preset station number.
 - * **+**: Selects higher preset station number.
 - * **-**: Selects lower preset station number.
 - A/B/C/D/E**: Selects the page (A-E) of preset station buttons.
- Controls LD player.
 - * Refer to "A/B switch" on the next page.





REMOTE CONTROL "LEARNING" FUNCTION

The keys on this remote control transmitter can be programmed to "learn" key-functions from other remote control transmitters. By using this feature, this unit can then be used in place of one or more other remote control transmitters, thus making operation of your various audio and video components more convenient. Moreover, each key can learn two functions by switching the learning page. Use the included user program sheets to indicate a new function learned for each key.

Note

There may occasionally be instances in which, due to the signal-coding and modulation employed by the other remote control transmitter, this unit will not be able to "learn" its signals.

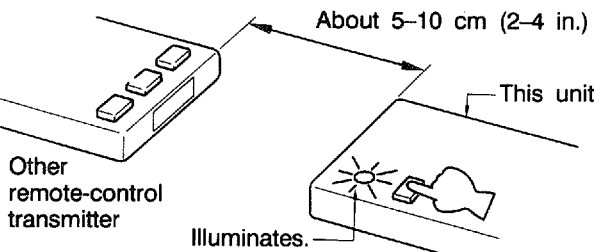
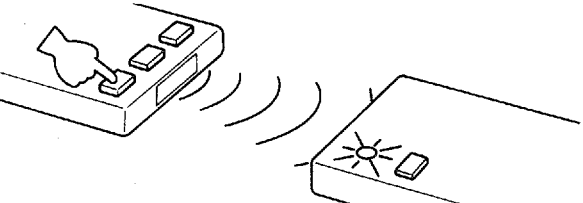
To Learn a New Function

1	 <p>Set to a desired learning page.</p>
2	 <p>Set to the "LEARN" position.</p>
3	<p>Press a key on this unit where a new function will be learned.</p>  <p>Other remote-control transmitter</p> <p>This unit</p> <p>Illuminates.</p>
4	<p>Press and hold the key (on the other remote control transmitter) where the desired new function is.</p>  <p>* When the TRANSMIT/LEARN indicator stops illuminating, the learning is finished.</p>
5	<p>Repeat the step 3 and 4 until all desired functions are successfully learned.</p>
6	<p>Set to the "USER" position.</p>  <p>Try operating your components.</p>

Notes

- When you operate the desired component with this remote control transmitter, **TRANSMIT/LEARN** indicator will flash steadily.
- The originally preset function of a key is still available in the **USER** position if a new function has not been learned to the key.
- Successful learning to a key results in the erasure of previously learned functions and their replacement by the newly learned ones.
- If there is no more room in the memory area for a function to be learned, the **TRANSMIT/LEARN** indicator will flash two times. In this case, even if some keys are not occupied with functions from other remote control transmitters, no further learning is possible.

Memory back-up

All of the learned functions will be retained while you replace the batteries. However, if no batteries are installed for a few hours, the learned functions will be erased and will have to be learned again.

Blank keys (Refer to the previous page.)

These keys have no preset functions and are used only for learning other remote control transmitter's functions.

1/2 switch (To switch the learning page)



This switch changes the learning page (1 or 2) of the all the keys except the shaded keys shown below in "A/B switch".

A/B switch (To switch the learning page)

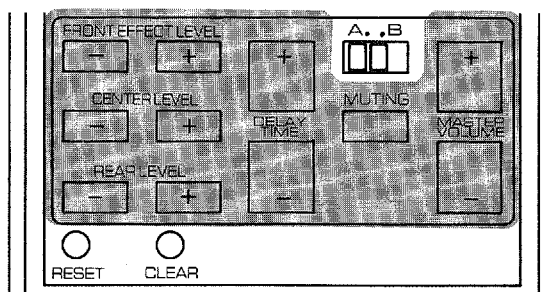
This switch changes the learning page (A or B) of the shaded keys shown below instead of the 1/2 switch.

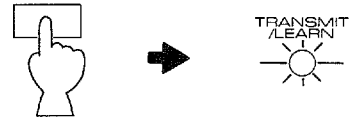

To Clear a Learned Function

1	 <p>USER RS...LEARN</p> <p>Set to the "USER" position.</p>
2	<p>Press and hold the CLEAR switch using the point of a mechanical pencil, etc..</p>  <p style="text-align: center;">CLEAR</p>
3	<p>Press and hold the key where the learned function to be deleted is until the indicator flashes 3 times.</p>  <p>To clear two or more functions, repeat steps 2 and 3.</p>

Note

If a key is not pressed soon after the **CLEAR** switch is pressed, this unit will automatically return to the status that was in effect before the **CLEAR** switch was pressed.

To Clear All Learned Functions

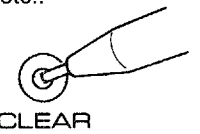
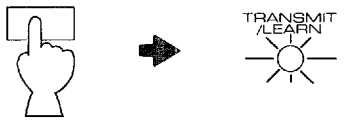
1	 <p>USER RS...LEARN</p> <p>Set to the "LEARN" position.</p>
2	<p>Press and hold the CLEAR switch using the point of a mechanical pencil, etc..</p>  <p style="text-align: center;">CLEAR</p>
3	<p>Press and hold any key until the indicator flashes 7 times.</p> 

NOTES ABOUT THE REMOTE CONTROL TRANSMITTER

Battery installation

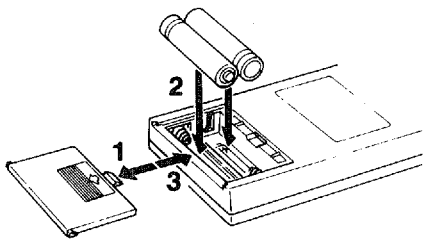

Battery replacement

If you find that the remote control transmitter must be used closer to the main unit, the batteries are weak. Replace both batteries with new ones.

Notes

- Use only AA, LR6, AM-3 batteries for replacement.
- Be sure the polarities are correct. (See the illustration inside the battery compartment.)
- Remove the batteries if the remote control transmitter will not be used for an extended period of time.
- If batteries leak, dispose of them immediately. Avoid touching the leaked material or letting it come in contact with clothing, etc. Clean the battery compartment thoroughly before installing new batteries.

Remote control transmitter operation range

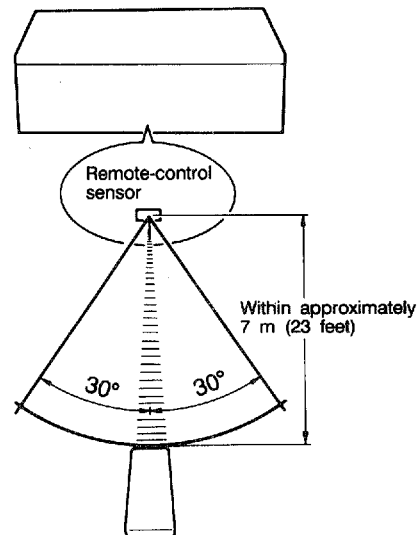

Notes

- There should be no large obstacles between the remote control transmitter and the main unit.
- If the remote control sensor is directly illuminated by strong lighting (especially an inverter type of fluorescent lamp etc.), it might cause the remote control transmitter not to work correctly. In this case, reposition the main unit to avoid direct lighting.

TROUBLESHOOTING

If the unit fails to operate normally, check the following points to determine whether the fault can be corrected by the simple measures suggested. If it cannot be corrected, or if the fault is not listed in the SYMPTOM column, disconnect the power cord and contact your authorized YAMAHA dealer or service center for help.

SYMPTOM	CAUSE	REMEDY
The unit fails to turn on when the POWER switch is pressed.	Power cord is not plugged in or is not completely inserted.	Firmly plug in the power cord.
No sound or no picture.	Incorrect output cord connections.	Connect the cords properly. If the problem persists, the cords may be defective.
	The MUTING switch is ON.	First, turn the volume control to the full left. Then, turn the MUTING switch OFF with the remote control transmitter and adjust the volume.
	Appropriate input selector is not pressed.	Press the appropriate input selector corresponding to the input source.
There is no sound or no picture when any input selector is pressed.	The input wires are not connected securely.	Connect them securely.
	The speaker systems are not connected correctly.	Check and secure the connections.
The sound suddenly goes off.	The protection circuit has activated because of short circuit etc.	Turning the unit off and then on will reset the protection circuit.
Only one side speaker outputs the sound.	Incorrect setting of the BALANCE control	Adjust it to the appropriate position.
	Incorrect cord connections.	Connect the cords properly. If the problem persists, the cords may be defective.
Sound "hums".	Incorrect cord connections.	Firmly connect the audio plugs. If the problem persists, the cords may be defective.
	No connection from the turntable to the GND terminal.	Make the GND connection between the turntable and this unit.
There is a lack of bass, and no ambience.	The + and - wires are connected in reversed at the amplifier or speakers.	Connect the speaker wires in the correct phase (+ and -).
The volume level is low in the record play.	The record play is performed on the turntable with the MC cartridge.	The player should be connected to the unit through the MC head amplifier.
No sound from the rear speakers.	The sound output level of the rear speakers is 0.	Turn up the sound output level with the REAR LEVEL key.
	The monaural sound source is played in the DOLBY PRO LOGIC or ENHANCED.	Select another program suitable for the monaural sound source.
No sound from the center speaker.	The sound output level of the center speaker is 0.	Turn up the sound output level with the CENTER LEVEL key.
	The center mode is in the PHANTOM.	Select the NORMAL or WIDE.
	Incorrect sound field program selection.	Select the appropriate program.
	No sound field program is selected.	
There is a howling sound when playing records at high volume.	The turntable and the speakers are too close together, or the turntable is not located on a firm surface.	Change the location of the turntable or the speakers.
The remote control transmitter does not work.	Direct sunlight or lighting (of an inverter type of fluorescent lamp etc.) is striking the remote control sensor of the main unit.	Change position of the main unit.
The distance or range within which the remote control transmitter can be used decreases.	The batteries of this remote control transmitter are too weak.	Replace the batteries with new ones.
The sound is degraded when monitoring is performed by using the headphones connected to the compact disc player or cassette deck which are connected with this unit.	Power cord of this unit is not plugged.	Plug in the power cord.

SPECIFICATIONS

Minimum RMS Output Power per Channel
Front L,R
 8 ohms, 20 Hz to 20 kHz, 0.03% THD
 [General model]65W+65W
 [Australia, Europe and U.K. models]60W+60W
Center
 8 ohms, 20 Hz to 20 kHz, 0.08% THD25W
Rear L,R
 8 ohms, 1 kHz, 0.3% THD25W+25W
Dynamic Power per Channel
 (by IHF Dynamic Headroom measuring method)
 8/6/4/2 ohms
 [General model]85/100/125/150W
 [Australia, Europe and U.K. models]82/96/120/145W
DIN Standard Output Power per Channel
 4 ohms, 1 kHz, 0.7% THD
 [Europe model only]100W
IEC Power
 8 ohms, 1 kHz, 0.01% THD
 [Europe model only]70W
Input Sensitivity/Impedance
 PHONO MM2.5 mV/47 k-ohms
 CD/TUNER/TAPE/LD-TV/VCR150 mV/47 k-ohms
 FRONT IN1V/47 k-ohms
Maximum Input Signal (1 kHz, 0.02% THD)
 PHONO MM80 mV

Output Level/Impedance
 REC OUT150 mV/1 k-ohms
 FRONT OUT1V/3.3 k-ohms
Headphone Jack Rated Output/Impedance
 8 ohms, 1 kHz, 0.01% THD
 Output Level0.45V
 Impedance390 ohms
Frequency Response (20 Hz to 20 kHz)
 CD/TUNER/TAPE/LD-TV/VCR0±0.5 dB
 FRONT IN0±0.5 dB
RIAA Equalization Deviation
 PHONO MM0±0.5 dB
Total Harmonic Distortion (20 Hz to 20 kHz)
 PHONO MM to REC OUT (1V)0.01%
 CD/TUNER/TAPE/LD-TV/VCR to SP OUT (30W/8 ohms)0.015%
 FRONT IN to SP OUT(30W/8 ohms)0.008%
Signal-to-Noise Ratio (IHF-A Network)
 PHONO MM (5 mV Input Shorted)More than 86 dB
 CD/TUNER/TAPE/LD-TV/VCR (Input Shorted)More than 95 dB
Residual Noise (IHF-A Network)120 µV
Channel Separation (Vol. -30 dB)
 PHONO MM (Input Shorted 1 kHz/10 kHz)65 dB/50 dB
 CD/TUNER/TAPE/LD-TV/VCR (Input 5.1 k-ohms Terminated 1 kHz/10 kHz)65 dB/50 dB

Tone Control Characteristics
BASS: Boost/cut±10 dB (20 Hz)
 Turnover Frequency350 Hz
TREBLE: Boost/cut±10 dB (20 kHz)
 Turnover Frequency3.5 kHz
Video Input Level/Impedance1V/75Ω
Video Output Level/Impedance1V/75Ω
Power Supply
 [U.S.A. and Canada models]AC 120V, 60 Hz
 [Australia and U.K. models]AC 240V, 50 Hz
 [Europe model]AC 230V, 50 Hz
 [General model]AC 110/120/220/240V, 60/50 Hz
Power Consumption160W
AC Outlets
 [Europe and General models]
 3 SWITCHED OUTLETS100W max. total
 [Australia and U.K. models]
 1 SWITCHED OUTLET100W max. total
Dimensions (W x H x D)
435 x 151.3 x 296.7 mm
 (17-1/8" x 5-15/16" x 11-11/16")
Weight10 kg (22 lbs. 0 oz.)
AccessoriesRemote control transmitter
 Batteries

Specifications are subject to change without notice.

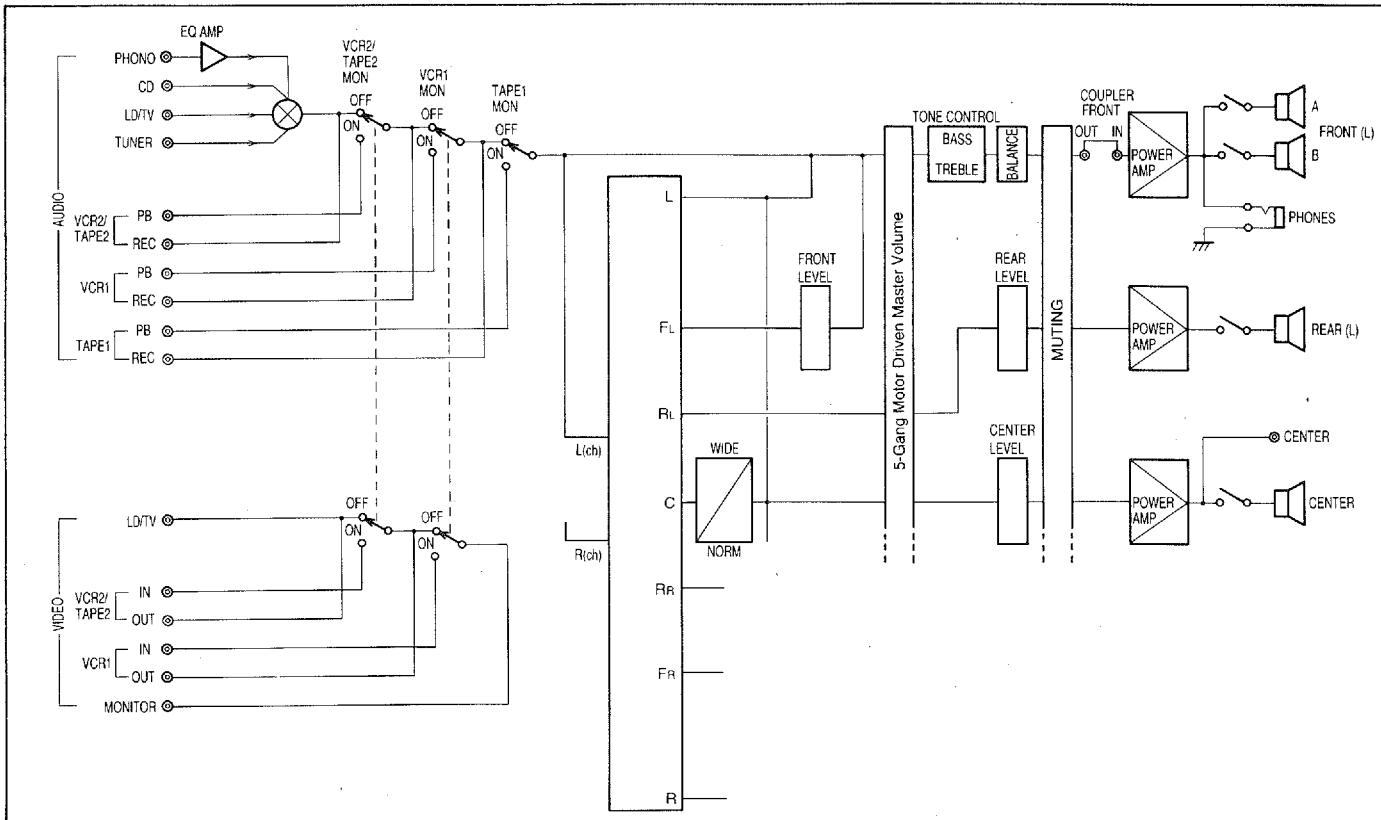

YAMAHA

YAMAHA ELECTRONICS CORPORATION, USA 6722 ORANGETHORPE AVE., BUENA PARK, CALIF. 90620, U.S.A.
YAMAHA CANADA MUSIC LTD. 135 MILNER AVE., SCARBOROUGH, ONTARIO M1S 3R1, CANADA
YAMAHA ELECTRONIK EUROPA G.m.b.H. SIEMENSSTR. 22-34, D-2084 REILINGEN BEI HAMBURG, F.R. OF GERMANY
YAMAHA ELECTRONIQUE FRANCE S.A. 17 RUE DES CAMPANULES, LOGNES 77321 MARNE LA VALLEE CEDEX 2, FRANCE
YAMAHA ELECTRONICS (UK) LTD. YAMAHA HOUSE, 200 RICKMANSWORTH ROAD WATFORD, HERTS WD1 7JS, ENGLAND
YAMAHA SCANDINAVIA A.B. J A WETTERGRENS GATA 1, BOX 30053, 400 43 VÄSTRA FRÖLUNDA, SWEDEN
YAMAHA MUSIC AUSTRALIA PTY, LTD. 17-33 MARKET ST., SOUTH MELBOURNE, 3205 VIC., AUSTRALIA

YAMAHA CORPORATION
VN23140 BWWP,R Printed in Japan ©