

# SPEAKER SYSTEM

## Installation Series

IF2115/AS(W), IF2112/AS(W)

### OWNER'S MANUAL

Thank you for choosing this Yamaha speaker system. In order to take maximum advantage of the speaker's features and ensure optimum performance and longevity, please read this manual carefully before using the speaker system. Keep the manual in safe place for future reference.

### BEDIENUNGSANLEITUNG

Vielen Dank für die Auswahl dieses Lautsprechersystems von Yamaha. Damit Sie die Eigenschaften dieses Lautsprechers optimal nutzen können, und um maximale Leistung und Lebensdauer sicherzustellen, lesen Sie bitte vor der Inbetriebnahme diese Anleitung sorgfältig durch. Bitte bewahren Sie diese Anleitung zum späteren Nachschlagen an einem sicheren Ort auf.

### MODE D'EMPLOI

Nous vous remercions d'avoir acheté ces enceintes Yamaha. Pour obtenir les performances optimales de vos enceintes et garantir une longévité maximale, lisez attentivement ce mode d'emploi avant d'utiliser les enceintes. Conservez-le en lieu sûr pour pouvoir vous y référer ultérieurement.

### MANUAL DE INSTRUCCIONES

Gracias por escoger este sistema de altavoces Yamaha. A fin de aprovechar al máximo las características de los altavoces y obtener un rendimiento y durabilidad óptimos, lea atentamente este manual antes de utilizar el sistema. Guarde este manual en un lugar seguro para futuras consultas.

### 取扱説明書

このたびは、ヤマハ製品をお買い求めいただきまして、まことにありがとうございます。  
スピーカーの優れた性能を十分に生かして、未永くご愛用いただくために、この取扱説明書をご使用の前に必ずお読みください。

# PRECAUTIONS

## PLEASE READ CAREFULLY BEFORE PROCEEDING

\* Please keep this manual in a safe place for future reference.

### CAUTION

Always follow the basic precautions listed below to avoid the possibility of physical injury to you or others, or damage to the device or other property. These precautions include, but are not limited to, the following:

#### Location

- If you use a stand, make sure to observe the following precautions in order to avoid toppling the device or causing damage to the internal components.
  - Check the stand's specifications and make sure that it is sturdy enough to support the weight of the speaker.
  - Mount only one speaker on each speaker stand.
  - Use the supplied screws if included.
  - Tighten fastening screws securely.
  - Use the speaker stands with their legs fully opened.
  - Use the stand at a height of less than 140cm.
  - Add weight such as sand bags around the stand legs to prevent them from falling over.
  - Remove the speakers from the stands before moving the stands or adjusting their height.
  - Limit the number of people around the placed stand.
- Always consult qualified Yamaha service personnel if the device installation requires construction work, and make sure to observe the following precautions.
  - Choose mounting hardware and an installation location that can support the weight of the device.
  - Avoid locations that are exposed to constant vibration.
  - Make sure to use the specified hardware.
  - Inspect the device periodically.
- When transporting or moving the device, always use two or more people. Attempting to lift the device by yourself may damage your back, result in other injury, or cause damage to the device itself.
- Before moving the device, remove all connected cables.
- Do not expose the device to excessive dust or vibrations, or extreme cold or heat (such as in direct sunlight, near a heater, or in a car during the day) to prevent the possibility of panel disfiguration or damage to the internal components.
- Do not place the device in an unstable position where it might accidentally fall over.

#### Connections

- Before connecting the device to other devices, turn off the power for all devices. Before turning the power on or off for all devices, set all volume levels to minimum.
- Use only speaker cables for connecting speakers to the speaker jacks. Use of other types of cables may result in fire.

#### Handling caution

- When choosing a power amplifier to use with your speakers, make sure that its power output matches the speakers' power capacity (refer to the Specifications on page 14). Even if the amplifier's power output is lower than the speakers' power capacity, the speakers may be damaged when clipping of a high input signal occurs. The following may cause damage to speakers:
  - Feedback caused when using a microphone.
  - Continuous high sound pressure level produced by electronic instruments.
  - Continuous high-power output of distorted signals.
  - Popping noises caused by turning on equipment, or by connecting or disconnecting system components while the amplifier is turned on.
- When turning on the AC power in your audio system, always turn on the power amplifier LAST, to avoid speaker damage. When turning the power off, the power amplifier should be turned off FIRST for the same reason.
- Do not operate this device at high volume levels or at a level that is uncomfortable, since it is capable of producing sound levels that could cause permanent hearing loss. If you experience any discomfort or ringing in the ears, or suspect an hearing loss, you should consult an audiologist.

Yamaha cannot be held responsible for damage caused by improper use or modifications to the device.

\* Illustrations herein are for explanatory purposes only, and may not match actual appearance during operation.

\* Company names and product names herein are trademarks or registered trademarks of their respective companies.

For details on signal processor settings when driving speakers with the use of multiple power amplifiers, please refer to the web site below.

Yamaha Pro Audio global web site  
<http://www.yamahaproaudio.com/>

## Bi-Amp/Passive switch

Select the Bi-Amp mode (bi-amp drive) or the Passive mode (full-range drive).

### ⚠ CAUTION

Do not change the Bi-amp/Passive setting while the speaker is in use.

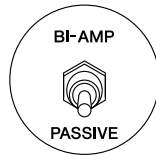

## Neutrik Speakon NL4 plug wiring

Connect the plugs as shown below.

### ⚠ CAUTION

Be sure to use proper speaker cable – not shielded instrument or line cable – for all speaker connections.

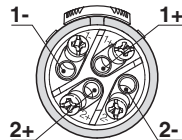

NEUTRIK plug	Bi-Amp	Passive
1+	LF+	+
1-	LF-	-
2+	HF+	
2-	HF-	

**NOTE** The Speakon jack and barrier strip terminals are connected in parallel.

## Suspended Installation

### ⚠ CAUTION

- The strength of the suspension points on the speaker is **60 kg** per point (maximum).
- Before doing any installation or construction work, consult with an installation expert.
- When choosing the installation location, suspension wire and mounting hardware, make sure all are strong enough to support the weight of the speaker.
- Some fittings may deteriorate over extended periods of time due to wear and/or corrosion. For optimum safety, the installation should be checked thoroughly at regular intervals.

**Yamaha cannot be held responsible for damage or injury caused by insufficient strength of the support structure or improper installation.**

### ■ Using eye bolts for suspension

For optimum safety, make sure to carefully follow the precautions below.

### ⚠ CAUTION

- Use only the supplied eye bolts.
- Use three or more eye bolts for suspended installations.
- Use the optional array frame if you intend to suspend a speaker from another suspended speaker.
- Install the eye bolts to multiple surfaces of the speaker, not just one surface.

### ■ Eye bolt strength

Keep in mind that the strength of the eye bolt differs depending on the suspension angle of the speaker. Make sure that the load for each eye bolt is less than 740 kg when suspending at an angle of 0 degrees, and less than 185 kg at an angle of 45 degrees.

### ⚠ CAUTION

When using the eye bolts, make sure that the suspension angle is within the range of 0 to 45 degrees, as shown below.

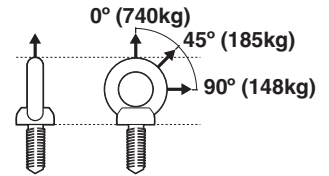

### ⚠ CAUTION

Do not suspend the eye bolts as shown in the diagram below.



## Rotatable horn

**NOTE** The horn directivity of the speaker is set at the factory so that the upward spread is narrow and the downward spread is wide.

1. Remove all fixing screws on the grille, and remove the grille from the speaker.
2. Remove all screws installed on the horn, pull out the horn from the speaker, rotate the horn 90 degrees, and re-install the horn to the speaker.

### ⚠ CAUTION

Be careful when rotating the horn so that you do not accidentally cut the connection wires connected to the horn driver.

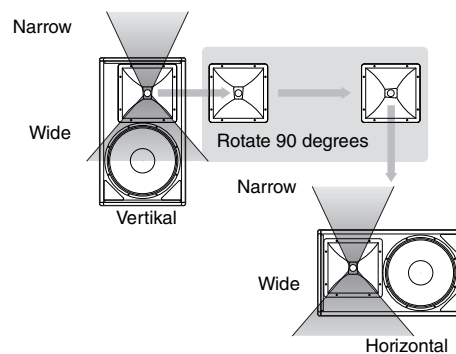

**NOTE** If you use the speaker as a floor monitor, change the horn dispersion so that the upward spread is wide and the downward spread is narrow, as shown in the diagram.

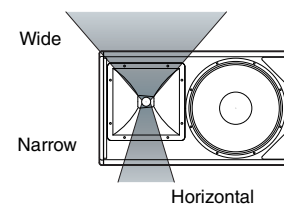

# Specifications

System Type	High power 2-way full-range speaker					
Model	IF2112/AS(W)			IF2115/AS(W)		
Specifications/Drive Mode	Passive	Bi-amp		Passive	Bi-amp	
Frequency Range (-10dB) (4π) <sup>*1</sup>	50 Hz – 20k Hz (Bi-amp mode)			45 Hz – 20k Hz (Bi-amp mode)		
Frequency Range (±3dB) (4π) <sup>*1</sup>	70 Hz – 20k Hz (Bi-amp mode)			60 Hz – 20k Hz (Bi-amp mode)		
Nominal Coverage (H x V, -6dB)	60 – 100° x 60°, can be rotated to 60° x 60 – 100°			60 – 100° x 60°, can be rotated to 60° x 60 – 100°		
Power Rating	600 W <sup>2</sup>	LF: 700 W (AES)	HF: 110 W (AES)	600 W <sup>2</sup>	LF: 700 W (AES)	HF: 110 W (AES)
Nominal Impedance	8 ohms	LF: 8 ohms	HF: 8 ohms	8 ohms	LF: 8 ohms	HF: 8 ohms
Sensitivity (1W@1m)	96dB SPL	LF: 96dB SPL	HF: 108dB SPL	97dB SPL	LF: 98dB SPL	HF: 108dB SPL
Calculated Peak SPL	130dB SPL	LF: 130dB SPL	HF: 134dB SPL	131dB SPL	LF: 132dB SPL	HF: 134dB SPL
Calculated Continuous SPL	124dB SPL	LF: 124dB SPL	HF: 128dB SPL	125dB SPL	LF: 126dB SPL	HF: 128dB SPL
<b>Components</b>						
LF	12" (30cm) Woofer, 4" (100mm) Voice Coil			15" (38cm) Woofer, 4" (100mm) Voice Coil		
HF	Rotatable Constant Directivity Horn, 1.4" (38mm) exit, 3" (76mm) Voice Coil Compression Driver			Rotatable Constant Directivity Horn, 1.4" (38mm) exit, 3" (76mm) Voice Coil Compression Driver		
<b>Enclosure</b>						
Dimensions (H x W x D)	695 x 378 x 333 mm (27.4 x 14.9 x 13.1 in)			770 x 448 x 374 mm (30.3 x 17.6 x 14.7 in)		
Weight	29 kg (64 lbs)			35 kg (77 lbs)		
Shape	Multi-angle wedge			Multi-angle wedge		
Material	5/8 inch (16mm), 11-ply Finnish Birch			5/8 inch (16mm), 11-ply Finnish Birch		
Finish	Textured Black (Textured White)			Textured Black (Textured White)		
Grill	16 gauge powder coated perforated steel grilles, backed with acoustically transparent reticulated foam			16 gauge powder coated perforated steel grilles, backed with acoustically transparent reticulated foam		
Connectors	2 x Neutrik NL4 and barrier strip, wired in parallel			2 x Neutrik NL4 and barrier strip, wired in parallel		
Flying Hardware	16 x M10 for shoulder eyebolts and U-bracket			16 x M10 for shoulder eyebolts and U-bracket		
Pole Mounts	One			One		
Handle	Two			Two		
<b>Optional Accessory</b>						
U-bracket	UB2112(W)			UB2115(W)		
Array Frame	n/a			n/a		
<b>3rd party accessory</b>						
Omnimount (US)	n/a			n/a		
Multimount (US, Allen products)	n/a			n/a		
Powermount (UK)	n/a			n/a		
Ohashi (Japan)	n/a			n/a		

\* 1: With recommended YAMAHA DSP configuration.

\* 2: 2 hrs. IEC noise.

\* Specifications and descriptions in this owner's manual are for information purposes only. Yamaha Corp. reserves the right to change or modify products or specifications at any time without prior notice. Since specifications, equipment or options may not be the same in every locale, please check with your Yamaha dealer.

\* Die technischen Daten und Beschreibungen in dieser Bedienungsanleitung dienen nur der Information. Yamaha Corp. behält sich das Recht vor, Produkte oder deren technische Daten jederzeit ohne vorherige Ankündigung zu verändern oder zu modifizieren. Da die technischen Daten, das Gerät selbst oder Sonderzubehör nicht in jedem Land gleich sind, setzen Sie sich im Zweifel bitte mit Ihrem Yamaha-Händler in Verbindung.

\* Les caractéristiques techniques et les descriptions du mode d'emploi ne sont données que pour information. Yamaha Corp. se réserve le droit de changer ou modifier les produits et leurs caractéristiques techniques à tout moment sans aucun avis. Du fait que les caractéristiques techniques, les équipements et les options peuvent différer d'un pays à l'autre, adressez-vous au distributeur Yamaha le plus proche.

\* Las especificaciones y descripciones de este manual del propietario tienen sólo el propósito de servir como información. Yamaha Corp. se reserva el derecho a efectuar cambios o modificaciones en los productos o especificaciones en cualquier momento sin previo aviso. Puesto que las especificaciones, equipos u opciones pueden no ser las mismas en todos los mercados, solicite información a su distribuidor Yamaha.

\*仕様および外観は改良のため予告なく変更することがあります。

# Dimensions

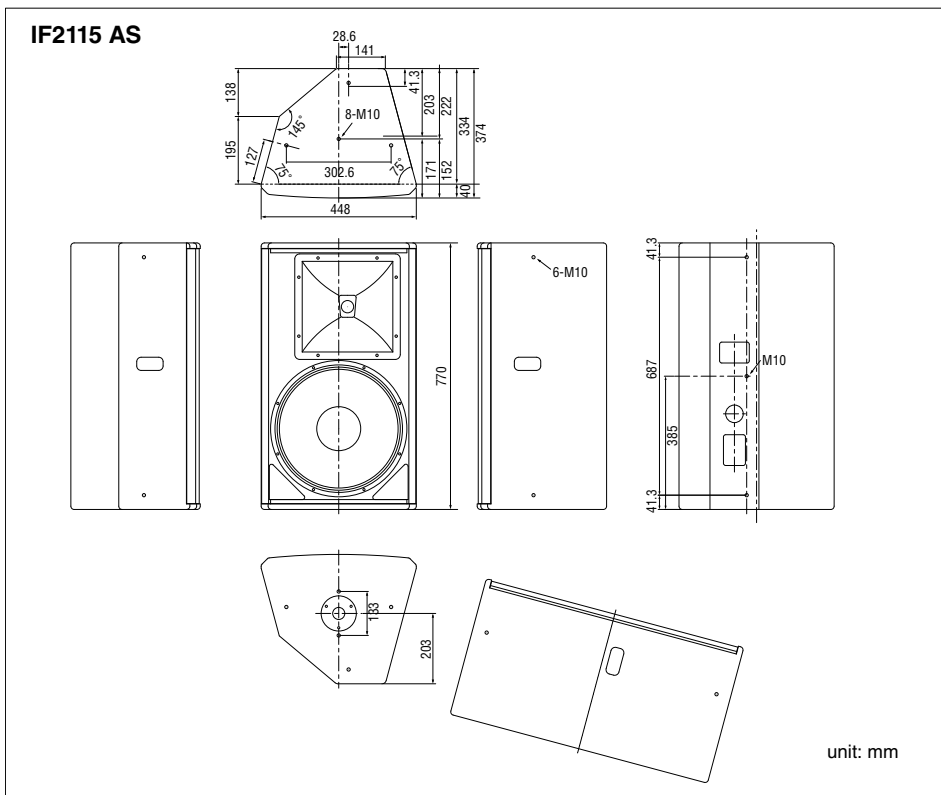
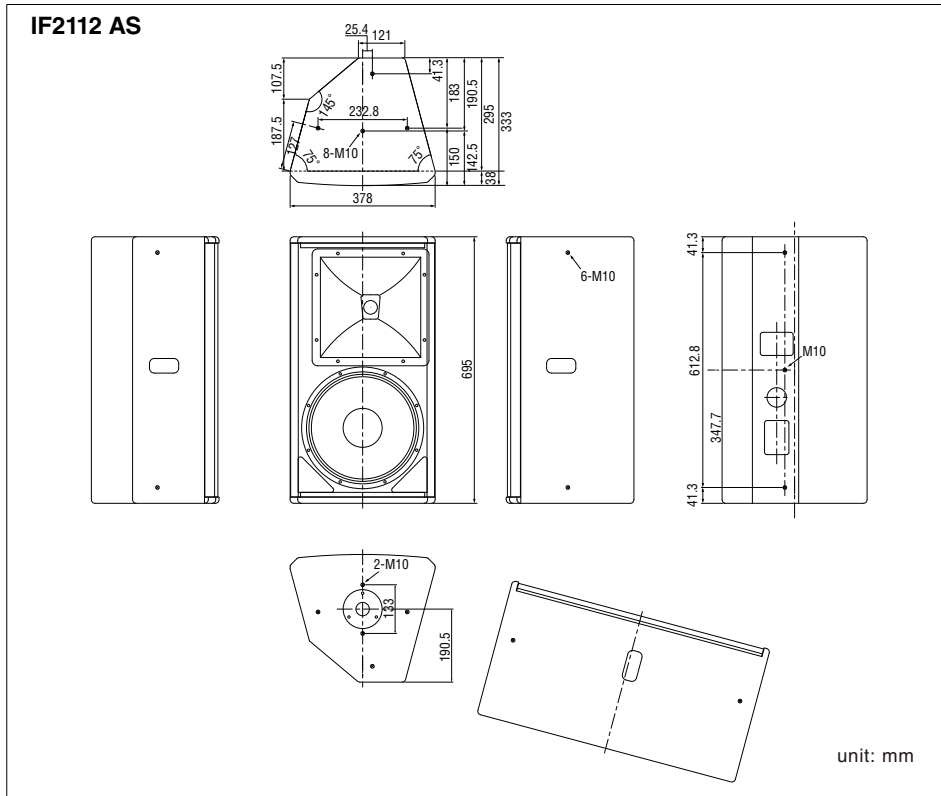

For details of products, please contact your nearest Yamaha representative or the authorized distributor listed below.

Pour plus de détails sur les produits, veuillez-vous adresser à Yamaha ou au distributeur le plus proche de vous figurant dans la liste suivante.

Die Einzelheiten zu Produkten sind bei Ihrer unten aufgeführten Niederlassung und bei Yamaha Vertragshändlern in den jeweiligen Bestimmungsländern erhältlich.

Para detalles sobre productos, contacte su tienda Yamaha más cercana o el distribuidor autorizado que se lista debajo.

## NORTH AMERICA

### CANADA

**Yamaha Canada Music Ltd.**  
135 Milner Avenue, Toronto, Ontario,  
M1S 3R1, Canada  
Tel: 416-298-1311

### U.S.A.

**Yamaha Corporation of America**  
6600 Orangethorpe Avenue, Buena Park, CA 90620,  
U.S.A.  
Tel: 714-522-9011

## CENTRAL & SOUTH AMERICA

### MEXICO

**Yamaha de México, S.A. de C.V.**  
Av. Insurgentes Sur 1647 Piso 9, Col. San José  
Insurgentes, Delegación Benito Juárez, México,  
D.F., C.P. 03900  
Tel: 55-5804-0600

### BRAZIL

**Yamaha Musical do Brasil Ltda.**  
Rua Joaquim Floriano, 913 - 4º andar, Itaim Bibi,  
CEP 04534-013 São Paulo, SP. BRAZIL  
Tel: 011-3704-1377

### ARGENTINA

**Yamaha Music Latin America, S.A.,  
Sucursal Argentina**  
Olga Cossetini 1553, Piso 4 Norte,  
Madero Este-C1107CEK  
Buenos Aires, Argentina  
Tel: 011-4119-7000

### VENEZUELA

**Yamaha Music Latin America, S.A.,  
Sucursal Venezuela**  
C.C. Manzanares Plaza P4  
Ofic. 0401- Manzanares-Baruta  
Caracas Venezuela  
Tel: 58-212-943-1877

### PANAMA AND OTHER LATIN AMERICAN COUNTRIES/ CARIBBEAN COUNTRIES

**Yamaha Music Latin America, S.A.**  
Torre Banco General, Piso No.7, Marbella,  
Calle 47 y Aquilino de la Guardia,  
Ciudad de Panamá, República de Panamá  
Tel: +507-269-5311

## EUROPE

### THE UNITED KINGDOM/IRELAND

**Yamaha Music Europe GmbH (UK)**  
Sherbourne Drive, Tilbrook, Milton Keynes,  
MK7 8BL, U.K.  
Tel: 01908-366700

### GERMANY

**Yamaha Music Europe GmbH**  
Siemensstraße 22-34, 25462 Rellingen, Germany  
Tel: 04101-3030

### SWITZERLAND/LIECHTENSTEIN

**Yamaha Music Europe GmbH  
Branch Switzerland in Zürich**  
Seefeldstrasse 94, 8008 Zürich, Switzerland  
Tel: 044-387-8080

### AUSTRIA/BULGARIA

**Yamaha Music Europe GmbH Branch Austria**  
Schleiergasse 20, A-1100 Wien, Austria  
Tel: 01-60203900

### CZECH REPUBLIC/HUNGARY/ ROMANIA/SLOVAKIA/SLOVENIA

**Yamaha Music Europe GmbH  
Branch Austria (Central Eastern Europe Office)**  
Schleiergasse 20, A-1100 Wien, Austria  
Tel: 01-60203900

### POLAND/LITHUANIA/LATVIA/ESTONIA

**Yamaha Music Europe GmbH  
Branch Poland Office**  
ul. Wrotkowa 14 02-553 Warsaw, Poland  
Tel: 022-500-2925

### MALTA

**Olimpus Music Ltd.**  
The Emporium, Level 3, St. Louis Street Msida  
MSD06  
Tel: 02133-2144

### NETHERLANDS/BELGIUM/ LUXEMBOURG

**Yamaha Music Europe Branch Benelux**  
Clarissenhof 5-b, 4133 AB Vianen, Netherlands  
Tel: 0347-358 040

### FRANCE

**Yamaha Music Europe**  
7 rue Ambroise Croizat, Zone d'activites Pariest,  
77183 Croissy-Beaubourg, France  
Tel: 01-64-61-4000

### ITALY

**Yamaha Music Europe GmbH, Branch Italy**  
Viale Italia 88, 20020 Lainate (Milano), Italy  
Tel: 02-935-771

### SPAIN/PORTUGAL

**Yamaha Music Europe GmbH Ibérica, Sucursal  
en España**  
Ctra. de la Coruna km. 17,200, 28231  
Las Rozas (Madrid), Spain  
Tel: +34-91-639-88-88

### GREECE

**Philippos Nakas S.A. The Music House**  
147 Skiathou Street, 112-55 Athens, Greece  
Tel: 01-228 2160

### SWEDEN/FINLAND/ICELAND

**Yamaha Music Europe GmbH Germany filial  
Scandinavia**  
J. A. Wettergrensgata 1, Box 30053  
S-400 43 Göteborg, Sweden  
Tel: +46 31 89 34 00

### DENMARK

**Yamaha Music Europe GmbH, Tyskland – filial  
Denmark**  
Generatorvej 6A, DK-2730 Herlev, Denmark  
Tel: 44 92 49 00

### NORWAY

**Yamaha Music Europe GmbH Germany -  
Norwegian Branch**  
Grini Næringspark 1, N-1361 Østerås, Norway  
Tel: 67 16 78 00

### RUSSIA

**Yamaha Music (Russia) LLC.**  
Room 37, bld. 7, Kievskaya street, Moscow,  
121059, Russia  
Tel: 495 626 5005

### OTHER EUROPEAN COUNTRIES

**Yamaha Music Europe GmbH**  
Siemensstraße 22-34, 25462 Rellingen, Germany  
Tel: +49-4101-3030

## AFRICA

**Yamaha Music Gulf FZE**  
Office JAFZA 16-512, P.O.Box 17328,  
Jebel Ali - Dubai, UAE  
Tel: +971-4-881-5868

## MIDDLE EAST

### TURKEY

**Yamaha Music Europe GmbH  
Merkezi Almanya Türkiye İstanbul Şubesi**  
Maslak Meydan Sokak No:5 Spring Giz Plaza  
Bağimsız Böl. No:3, 34398 Şişli İstanbul  
Tel: +90-212-999-8010

### CYPRUS

**Yamaha Music Europe GmbH**  
Siemensstraße 22-34, 25462 Rellingen, Germany  
Tel: 04101-3030

### OTHER COUNTRIES

**Yamaha Music Gulf FZE**  
Office JAFZA 16-512, P.O.Box 17328,  
Jebel Ali - Dubai, U.A.E  
Tel: +971-4-881-5868

## ASIA

### THE PEOPLE'S REPUBLIC OF CHINA

**Yamaha Music & Electronics (China) Co.,Ltd.**  
2F, Yunhedasha, 1818 Xinzha-lu, Jingan-qu,  
Shanghai, China  
Tel: 021-6247-2211

### INDIA

**Yamaha Music India Pvt. Ltd.**  
Spazedge building, Ground Floor, Tower A, Sector  
47, Gurgaon- Sohna Road, Gurgaon, Haryana, India  
Tel: 0124-485-3300

### INDONESIA

**PT. Yamaha Musik Indonesia (Distributor)**  
Yamaha Music Center Bldg. Jalan Jend. Gatot  
Subroto Kav. 4, Jakarta 12930, Indonesia  
Tel: 021-520-2577

### KOREA

**Yamaha Music Korea Ltd.**  
8F, 9F, Dongsung Bldg. 158-9 Samsung-Dong,  
Kangnam-Gu, Seoul, Korea  
Tel: 02-3467-3300

### MALAYSIA

**Yamaha Music (Malaysia) Sdn., Bhd.**  
No.8, Jalan Perbandaran, Kelana Jaya, 47301  
Petaling Jaya, Selangor, Malaysia  
Tel: 03-78030900

### SINGAPORE

**Yamaha Music (Asia) Private Limited**  
Block 202 Hougang Street 21, #02-00,  
Singapore 530202, Singapore  
Tel: 65-6747-4374

### TAIWAN

**Yamaha Music & Electronics Taiwan Co.,Ltd.**  
3F, No.6, Section 2 Nan-Jing East Road, Taipei,  
Taiwan R.O.C.  
Tel: 02-2511-8688

### THAILAND

**Siam Music Yamaha Co., Ltd.**  
3, 4, 15 and 16th floor, Siam Motors Building,  
891/1 Rama 1 Road, Wangmai,  
Pathumwan, Bangkok 10330, Thailand  
Tel: 02-215-2622

### VIETNAM

**Yamaha Music Vietnam Company Limited**  
15th Floor, Nam A Bank Tower, 201-203 Cach  
Mang Thang Tam St., Ward 4, Dist.3,  
Ho Chi Minh City, Vietnam  
Tel: +84-8-3818-1122

### OTHER ASIAN COUNTRIES

**Yamaha Corporation  
Sales & Marketing Division**  
Nakazawa-cho 10-1, Naka-ku, Hamamatsu,  
Japan 430-8650  
Tel: +81-53-460-2312

## OCEANIA

### AUSTRALIA

**Yamaha Music Australia Pty. Ltd.**  
Level 1, 99 Queensbridge Street, Southbank,  
Victoria 3006, Australia  
Tel: 3-9693-5111

### COUNTRIES AND TRUST TERRITORIES IN PACIFIC OCEAN

**Yamaha Corporation  
Sales & Marketing Division**  
Nakazawa-cho 10-1, Naka-ku, Hamamatsu,  
Japan 430-8650  
Tel: +81-53-460-2312