

HTR-3063

Quick Reference Guide

Accessories

The following accessories are supplied with this product.

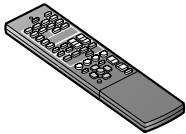

Remote control

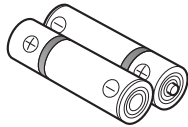

Batteries (2) (AAA, R03, UM-4)

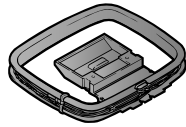

AM loop antenna



Indoor FM antenna

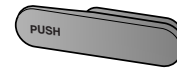

VIDEO AUX input cover



YPAO microphone

Preparing the remote control

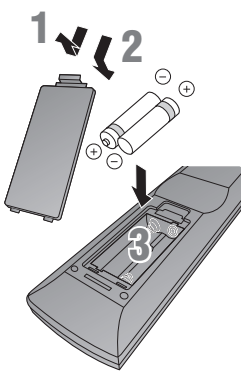

- 1 Take off the battery compartment cover.
- 2 Insert the two supplied AAA batteries into the battery case, following the polarity markings.
- 3 Snap the battery compartment cover back into place.

Items necessary for connection

Speakers



Front speaker

Ex.



Center speaker

Ex.



Surround speaker

Ex.

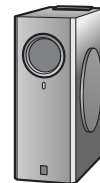

Active subwoofer

Ex.

- Use speakers with an impedance of at least 6Ω.
- If you are using a CRT TV, we recommend that you use magnetically shielded speakers.
- Prepare at least two speakers (for front). The priority of the other speakers is as follows:
 - 1 Two surround speakers
 - 2 One center speaker

External components



TV



Playback device such as BD (Blu-ray Disc)/DVD players

Cable

- Cables for connecting external components (may differ depending on the devices you are connecting)
- Speaker cables (a quantity to match the number of speakers you are connecting)
- Audio pin cable (for subwoofer)

Connect and install as follows the first time you use this unit.

See the following explanations for the connections for each number.

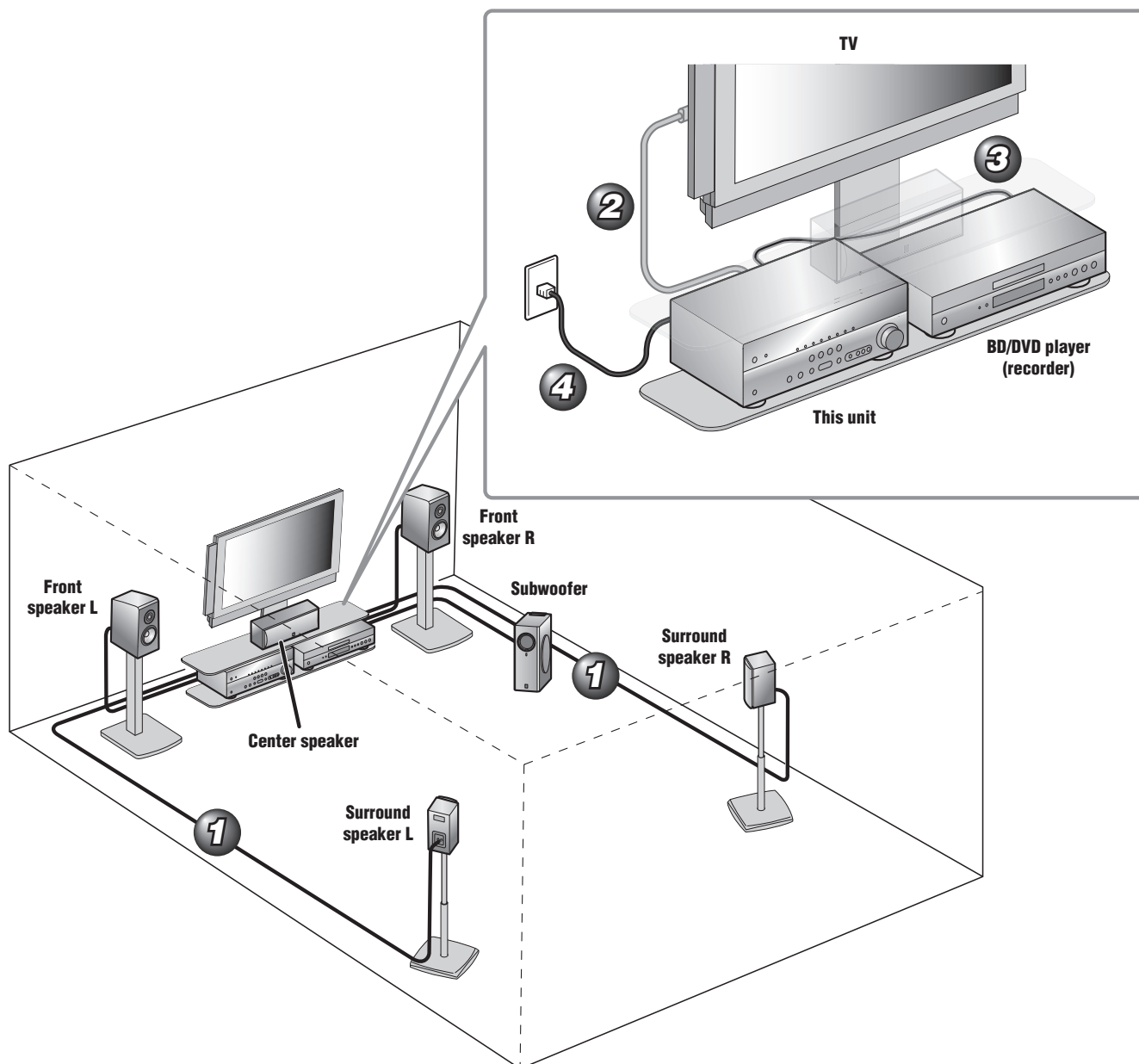

1 Connect the speakers

2 Connect a TV

3 Connect playback device such as BD/DVD players and recorders

4 Connect the AC power cord, and turn the power on

When connection and installation is finished, set up the speaker parameters automatically **5** .

1 Connect the speakers

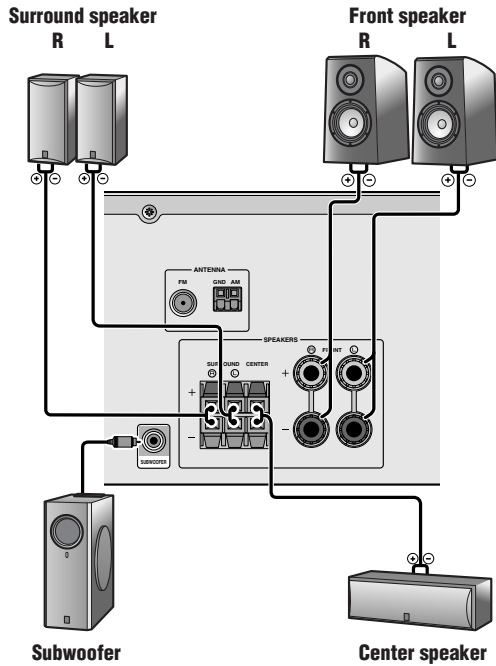

Caution:

- Remove the AC power cord of this unit from the power outlet before connecting the speakers.
- Generally speaker cables consist of two parallel insulated cables. One of these cables is a different color, or has a line running along it, to indicate different polarity. Insert the different colored (or lined) cable into the "+" (positive, red) terminal on this unit and the speakers, and the other cable into the "-" (minus, black) terminal.
- Be careful that the core of the speaker cable does not touch anything or come into contact with the metal areas of this unit. This may damage this unit or the speakers. If the speaker cables short circuit, "CHECK SP WIRES!" will appear on the front panel display when this unit is switched on.

Connecting front speakers

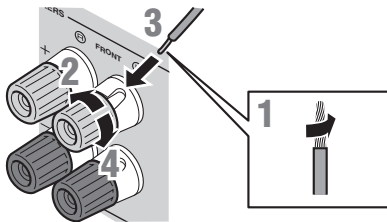

- 1 Remove approximately 10mm of insulation from the ends of the speaker cables, and twist the bare wires of the cables together firmly so that they will not cause short circuits.
- 2 Loosen the speaker terminals.
- 3 Insert the bare wire of the speaker cable into the gap on the side of the terminal.
- 4 Tighten the terminal.

Connecting the banana plug (Except U.K., Europe, Asia and Korea models)

Tighten the knob, and then insert the banana plug into the end of the terminal.

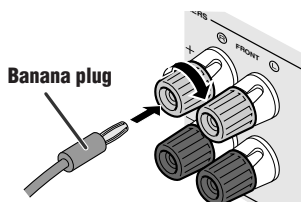

Connecting center speakers / surround speakers

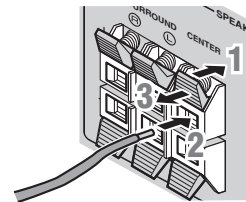

- 1 Press the tab on the speaker terminal down.
- 2 Insert the speaker cable end into the terminal.
- 3 Lift the tab to fix the speaker cable in place.

Connecting the subwoofer

- 1 Connect the subwoofer input jack to the SUBWOOFER jack on this unit with an audio pin cable.

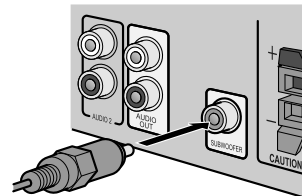

- 2 Set the subwoofer volume as follows.
Volume: Set to approximately half volume (or slightly less than half).
Crossover frequency (if available): Set to maximum.

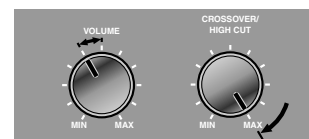

Subwoofer examples

2 Connect a TV

Video input to this unit is output to a TV using output jacks of the same kind.

When you have made connections using different types of video such as HDMI and component video, make the same connection with your TV. When viewing, be sure to switch the input source on your TV to match the playback device.

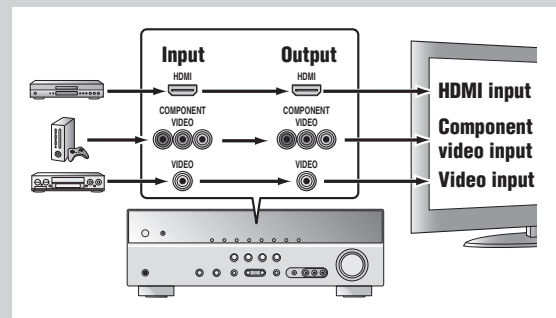

If your TV has multiple inputs, connect with the following priority (A) to (C).

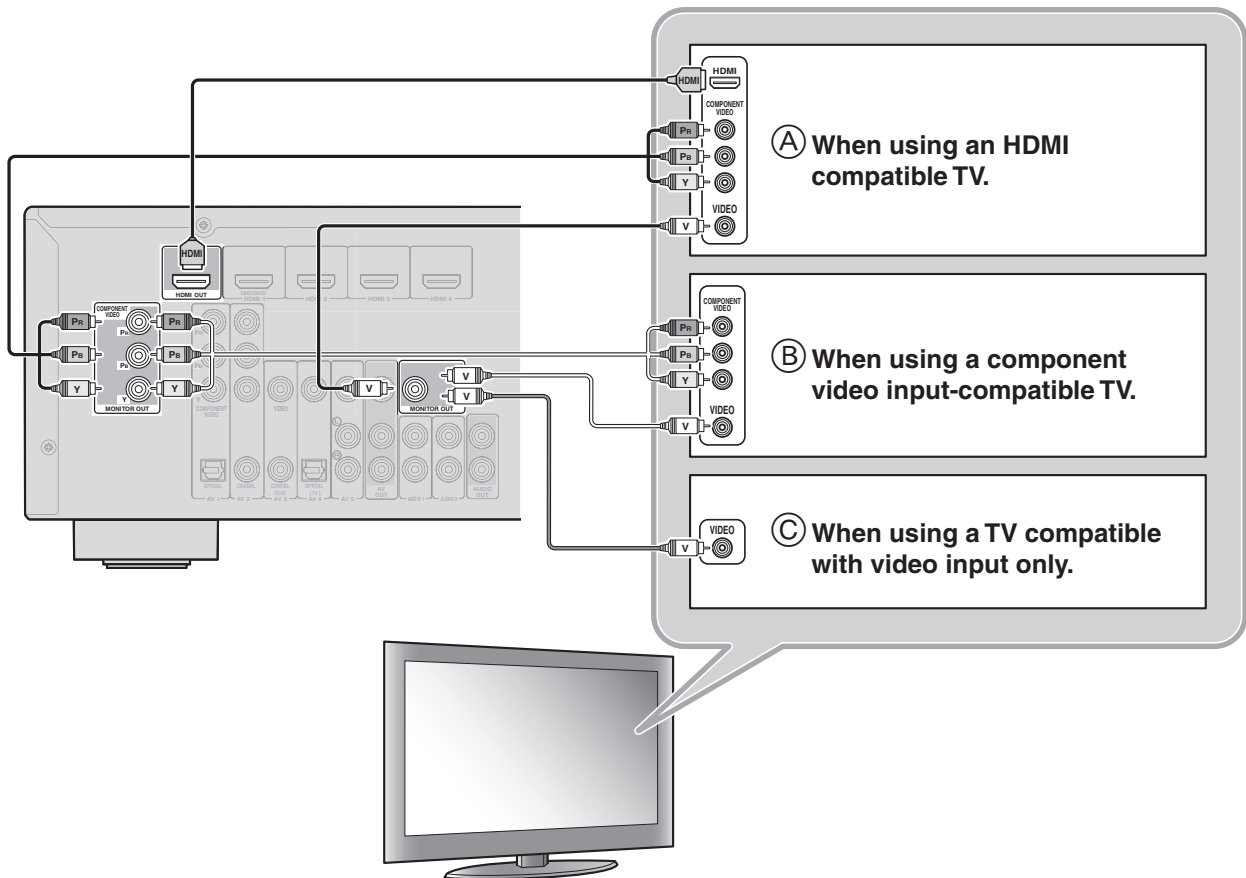

Listening to TV audio

To playback TV audio on this unit, connect the TV audio output to this unit.

Connect the following input jacks, matching the audio output jacks on your TV. When viewing your TV, select the appropriate input source on this unit.

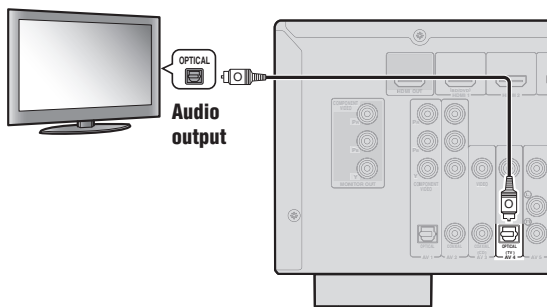

Audio output from TV	Input jack on this unit
Optical digital output	AV1 or AV4
Coaxial digital output	AV2 or AV3
Analog output	One of AV5, AUDIO1, or AUDIO2

* Connecting to AV4 allows you to playback TV audio just by pressing the "TV" under "SCENE" key.

3

Connect playback device such as BD/DVD players and recorders

If your playback device has multiple audio/video outputs, connect with the following priority (A to D) to enjoy a higher quality sounds and images.

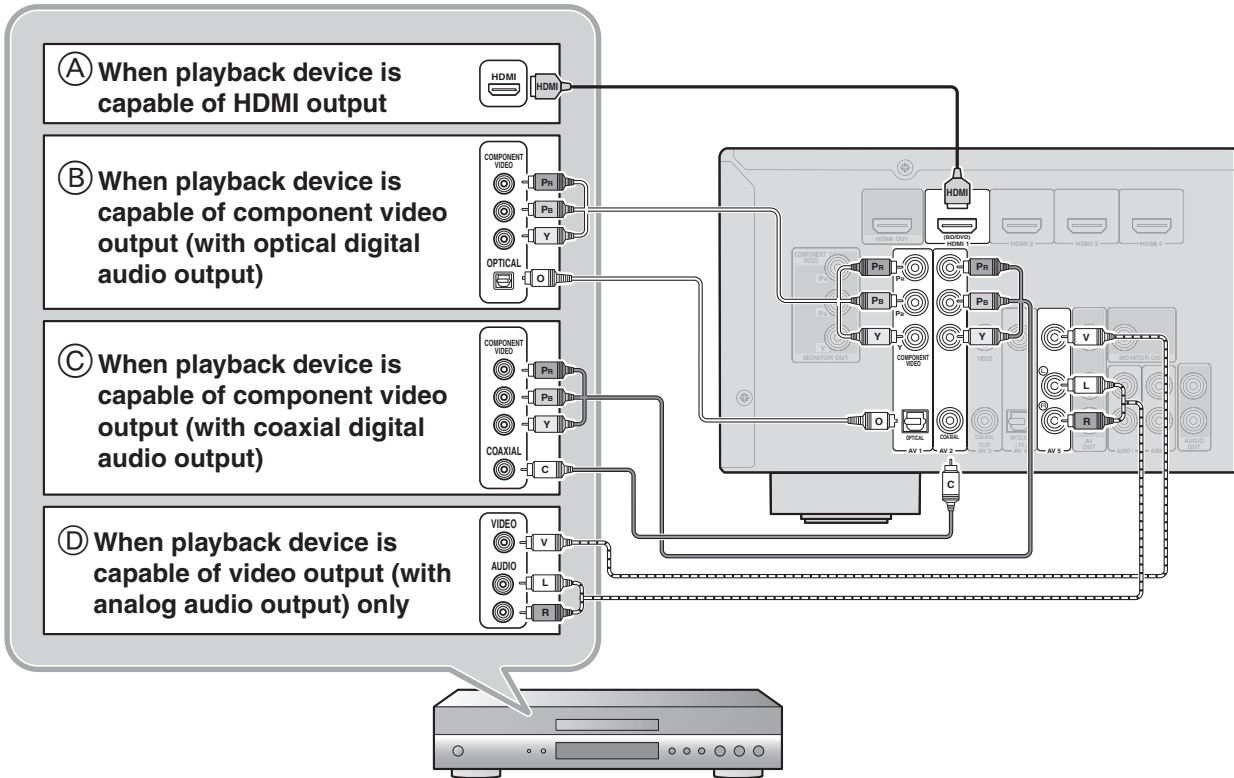

- When playback, select the corresponding input source the jack is connected.
- Connecting to HDMI1 allows you to select the HDMI input just by pressing the “BD/DVD” under “SCENE” key.
- Connecting to AV3 allows you to select the AV3 input just by pressing the “CD” under “SCENE” key.
- If necessary, you can connect components that cannot be connected using the above methods, such as devices that output video from component video output jacks and audio from analog output jacks. Refer to Owner’s Manual for details.

4

Connect the AC power cord, and turn the power on

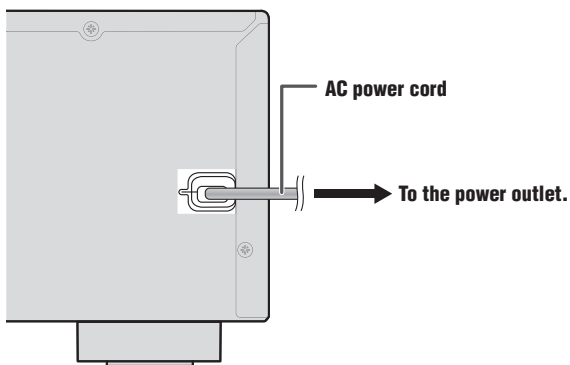

Be sure to aim the remote control directly at the remote control sensor on this unit during operation.

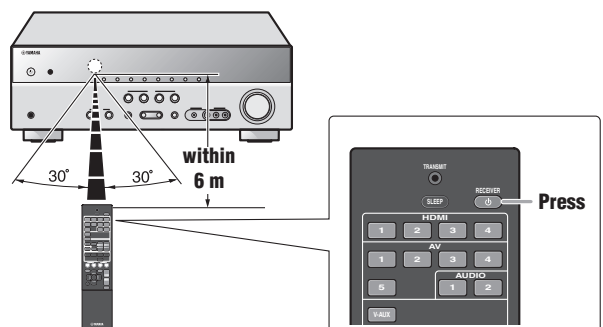

5 Set up the speaker parameters automatically (YPAO)

When connection is finished, adjust the status, sizes, and volume balance of the speakers to provide an optimal sound field. This unit is equipped with a YPAO (Yamaha Parametric Room Acoustic Optimizer) function that adjusts the speaker balance automatically with a simple procedure.

When you use YPAO, a test tone will be output from the speakers for approximately three minutes and acoustic measuring will be performed. When using YPAO, be careful of the following.

- The test tone is output at high volume. Please refrain from using this function at night when it may be a nuisance to others nearby.
- Please take care that the test tone does not frighten any small children.

1 Check the following before using YPAO.

This unit

- The headphones are removed.

Subwoofer

- The power is turned on.
- Volume is set to approximately half, and the cross-over frequency (if present) is set to maximum.

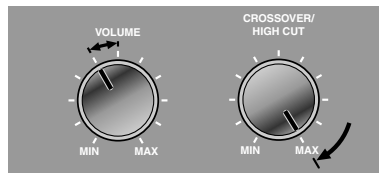

Subwoofer examples

2 Place the supplied YPAO microphone at ear height in your listening position.

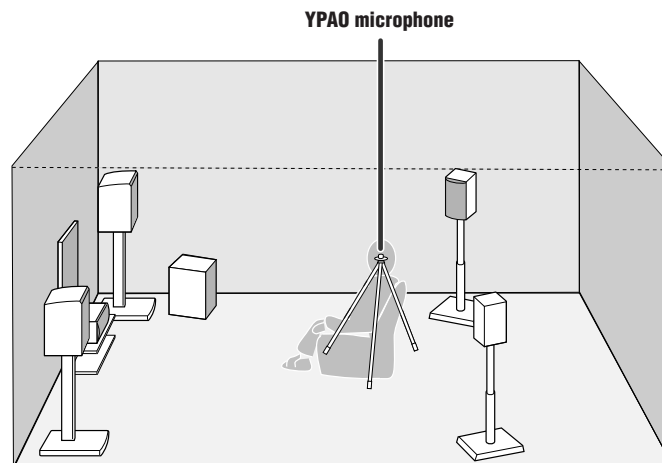

When positioning the microphone, we recommend that you use equipment that allows you to adjust the height (such as a tripod) as a microphone stand. When using a tripod, use the tripod screws to fix the microphone in place.

3 Press **RECEIVER** on the remote control to switch this unit on.

Continues to
the next page

- 4 Connect the YPAO microphone to the YPAO MIC jack on the front panel.

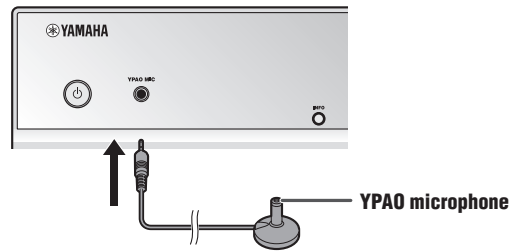

"MIC ON. YPAO START" appears on the front panel display, and then changes to display the following.



This completes preparations. To achieve more accurate results, be careful of the following when measuring.

- Measuring will take approximately three minutes. Keep the room as quiet as possible during measurement.
- Wait in the corner of the listening room during measurement or leave it entirely, to avoid becoming an obstruction between the speakers and the YPAO microphone.

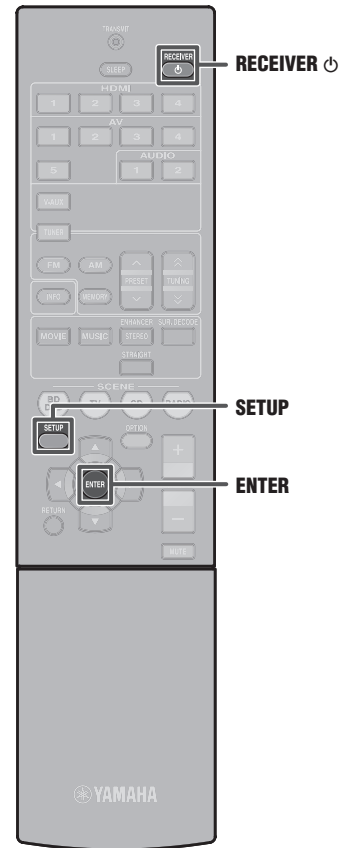

- 5 Press **SETUP** on the remote control to start measurement.



The following display appears if measurement finishes without any problems.



Note

When a problem occurs, an error message or a warning message appears either during or after measurement. Refer to "Set up the speaker parameters automatically (YPAO)" in Owner's Manual to solve the problem, and carry out YPAO again.

- 6 Press **ENTER** on the remote control to apply the results of measurement.



- 7 Remove the YPAO microphone.

YPAO finishes automatically when the YPAO microphone is removed.

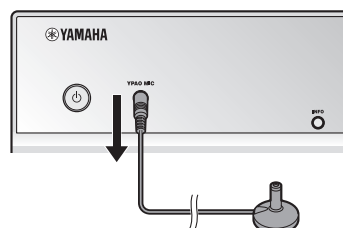

Operation guide

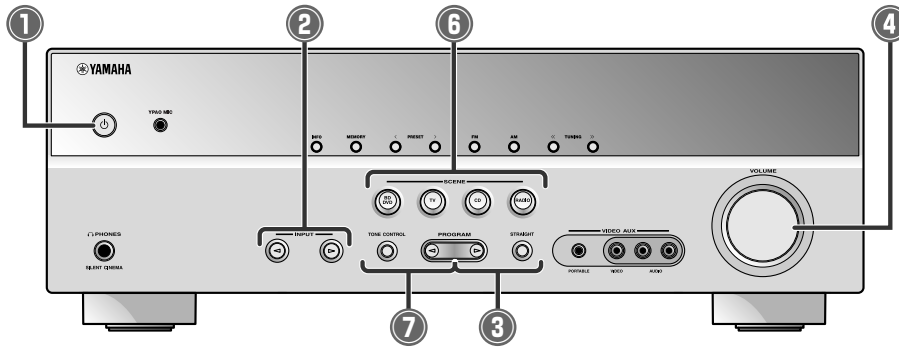

1 Switches this unit between on and standby modes
This unit switches between on and standby mode every time you press this key.

2 Choose an input source to listen to
The name of the selected input source appears on the front panel display.



3 Select sound field programs and sound decoders

Front panel	Remote control	Description
	MOVIE	Selects sound field programs optimized for viewing movies, dramas, and sports.
	MUSIC	Selects sound field programs optimized for appreciating music.
	ENHANCER STEREO	Selects settings for stereo playback or enhancers for compressed audio.
	SUR. DECODE	Selects surround decoders such as Dolby Pro Logic II.
	STRAIGHT	Switches to straight decoding mode for faithful reproduction of audio / video.

4 Adjusts the volume level
The current volume level is displayed on the front panel display.



5 Mutes the sound
The indicator blinks while the sound is muted.

6 Switches between input settings
You can switch input sources and sound field programs with a single key.

SCENE	Input	Sound field program
BD/DVD	HDMI 1	Straight
TV	AV4	Straight
CD	AV3	Straight
RADIO	TUNER	5ch Enhancer

- Pressing and holding this key allows you to store input sources/sound field programs.
- Press this key when this unit is in standby mode to switch on the unit.

7 Adjusting high/low-frequency sound (Tone control)

1 Press **TONE CONTROL** to select "Treble" or "Bass."



2 Press **PROGRAM** ◀ / ▶ to increase the setting.

- You can set the tone control for speakers and headphones separately. Connect the headphones when adjusting the headphone tone control.
- If you set an extreme tone balance, sounds may not match those from other channels.

