

YAMAHA
PortaSound



PSS-12

OWNER'S MANUAL

**Congratulations on your purchase of the Yamaha PortaSound.
You now own a portable keyboard that packs advanced functions
and great sound in a highly compact size.
Read this Owner's Manual carefully while playing your new PortaSound in
order to take full advantage of its various features.**

Limited Warranty

90 DAYS LABOR

1 YEAR PARTS

Yamaha Corporation of America, hereafter referred to as Yamaha, warrants to the original consumer of a product included in the categories listed below, that the product will be free of defects in materials and/or workmanship for the periods indicated. This warranty is applicable to all models included in the following series of products:

PSS SERIES OF PORTASOUND ELECTRONIC KEYBOARDS

If during the first 90 days that immediately follows the purchase date, your new Yamaha product covered by this warranty is found to have a defect in material and/or workmanship, Yamaha and/or its authorized representative will repair such defect without charge for parts or labor.

If parts should be required after this 90 day period but within the one year period that immediately follows the purchase date, Yamaha will, subject to the terms of this warranty, supply these parts without charge. However, charges for labor, and/or any miscellaneous expenses incurred are the consumers responsibility. Yamaha reserves the right to utilize reconditioned parts in repairing these products and/or to use reconditioned units as warranty replacements.

THIS WARRANTY IS THE ONLY EXPRESS WARRANTY WHICH YAMAHA MAKES IN CONNECTION WITH THESE PRODUCTS. ANY IMPLIED WARRANTY APPLICABLE TO THE PRODUCT, INCLUDING THE WARRANTY OF MERCHANTABILITY IS LIMITED TO THE DURATION OF THE EXPRESS WARRANTY. YAMAHA EXCLUDES AND SHALL NOT BE LIABLE IN ANY EVENT FOR INCIDENTAL OR CONSEQUENTIAL DAMAGES.

Some states do not allow limitations that relate to implied warranties and/or the exclusion of incidental or consequential damages. Therefore, these limitations and exclusions may not apply to you.

This warranty gives you specific legal rights. You may also have other rights which vary from state to state.

CONSUMERS RESPONSIBILITIES

If warranty service should be required, it is necessary that the consumer assume certain responsibilities:

1. Contact the Customer Service Department of the retailer selling the product, or any retail outlet authorized by Yamaha to sell the product for assistance. You may also contact Yamaha directly at the address provided below.
2. Deliver the unit to be serviced under warranty to: the retailer selling the product, an authorized service center, or to Yamaha with an explanation of the problem. Please be prepared to provide proof purchase date (sales receipt, credit card copy, etc.) when requesting service and/or parts under warranty.
3. Shipping and/or insurance costs are the consumers responsibility.* Units shipped for service should be packed securely.

* Repaired units will be returned PREPAID if warranty service is required within the first 90 days.

IMPORTANT: Do NOT ship anything to ANY location without prior authorization. A Return Authorization (RA) will be issued that has a tracking number assigned that will expedite the servicing of your unit and provide a tracking system if needed.

4. Your owners manual contains important safety and operating instructions. It is your responsibility to be aware of the contents of this manual and to follow all safety precautions.

EXCLUSIONS

This warranty does not apply to units whose trade name, trademark, and/or ID numbers have been altered, defaced, exchanged removed, or to failures and/or damages that may occur as a result of:

1. Neglect, abuse, abnormal strain, modification or exposure to extremes in temperature or humidity
2. Improper repair or maintenance by any person who is not a service representative of a retail outlet authorized by Yamaha to sell the product, an authorized service center, or an authorized service representative of Yamaha
3. This warranty is applicable only to units sold by retailers authorized by Yamaha to sell these products in the U.S.A., the District of Columbia, and Puerto Rico. This warranty is not applicable in other possessions or territories of the U.S.A. or in any other country.

Please record the model and serial number of the product you have purchased in the spaces provided below.

Model _____ Serial # _____ Sales Slip # _____

Purchased from _____ Date _____
(Retailer)

YAMAHA CORPORATION OF AMERICA
Electronic Service Division
6600 Orangethorpe Avenue
Buena Park, CA 90620

KEEP THIS DOCUMENT FOR YOUR RECORDS. DO NOT MAIL!

Main Features

Your PortaSound has the following features and functions:

- Authentic instrument sounds with 100 AWM (Advanced Wave Memory) Voices, utilizing digital recordings of actual instruments.
- 15 Songs, for listening enjoyment or for playing along with when using the Minus One function.
- 15 Jam Track patterns, providing specially programmed rhythms and chord progressions for playing along with.
- One Touch Setting, for automatically calling up an appropriate Voice for playing with the Song or Jam Track you select.
- Built-in amplifier and dual speaker system.

Taking Care of Your PortaSound

Your PortaSound will give you years of playing pleasure, provided you follow the simple precautions given below.

- Avoid exposure to direct sunlight or other sources of heat. Never leave it inside a car where it can get very hot. Also avoid highly humid or dusty places.
- Do not use your PortaSound close to television sets, radios or similar equipment since this may cause interference noise in the other appliance.
- Protect your PortaSound from strong impact. Be careful not to drop it or place heavy objects on it. Avoid applying excessive force to the controls and keys.
- After use, always turn off the POWER switch. When not using your PortaSound for long periods, be sure to remove the batteries to avoid damage through battery leakage.
- Clean the exterior with a soft, dry cloth. To remove stubborn stains, use a slightly moistened cloth. Never use alcohol, thinner, or other chemical solvents, since they will damage the finish. Also, do not leave vinyl chloride material on the PortaSound for a long time, since it may adhere to the exterior.

 **NOTE** Yamaha is not responsible for damage caused by improper usage.

Jam Track Mode — Chord Progressions

DANCE . 120			
Am7	%	Em7	%
Dm7	%	Am7	%
RAP . 116			
Am7	%	%	%
Am7	%	%	%
FUNK . 92			
C7	F7	C7	F7
ROCK . 124			
C	%	%	%
F	%	C	%
G	F	C	G
MINOR BLUES . 144			
Am	%	%	%
Dm	%	Am	%
E	%	Am	%
ROCK'N'ROLL . 144			
C	Am	F	G
R&B . 136			
C7	F7	G7 F7	C7

SLOW ROCK . 88			
C	Am7	F	G7
JAZZ BLUES . 160			
C7	F7	C7	%
F7	%	C7	A7
Dm7	G7	C7 A7	Dm7 G7
FUSION . 128			
Dm7	%	G7	%
BOSSA NOVA . 160			
Em7	Eb7	Dm7	Db7
SAMBA . 112			
C F G	%	%	%
TANGO . 124			
E7	%	Am	%
MARCH . 120			
C	%	G7	C
WALTZ . 160			
C	%	G7	%
G7	%	C	%



Voice List

PIANO		12STR GUITAR		ACCORDION	
NORMAL	Piano	NORMAL	12Strings Guitar	NORMAL	Accordion
VARI1	Honky-tonk Piano	VARI1	12Strings Jazz Guitar	VARI1	Accordion Octave
VARI2	Piano Country	VARI2	12Strings Electric Guitar	VARI2	Harmonica
VARI3	Piano Block	VARI3	Electric & Acoustic Guitar	VARI3	Harmonica Duet
E PIANO		BANJO		TRUMPET	
NORMAL	Electric Piano	NORMAL	Banjo	NORMAL	Trumpet
VARI1	Sustained Electric Piano	VARI1	Banjo Echo	VARI1	Trumpet Duet
VARI2	Electric Acoustic Piano	VARI2	Banjo Duet	VARI2	Trombone
VARI3	Electric Piano Trio	VARI3	Banjo Trio	VARI3	Horn
PIANO ENS		HARP		BRASS ENS	
NORMAL	Piano & Strings	NORMAL	Harp	NORMAL	Brass Ensemble
VARI1	Electric Piano & Strings	VARI1	Sustained Harp	VARI1	Brass Ensemble Dual
VARI2	Chorused Electric Piano	VARI2	Harp Echo	VARI2	Brass Ensemble & Tenor Sax
VARI3	Piano & Vibraphone	VARI3	Harp Duet	VARI3	Sax Ensemble
HARPSICHORD		STRINGS		FANTASY	
NORMAL	Harpsichord	NORMAL	Strings	NORMAL	Fantasy
VARI1	Harpsichord Echo	VARI1	Sustained Strings	VARI1	Synth Brass
VARI2	Harpsichord Octave	VARI2	Strings Duet	VARI2	Synth Lead
VARI3	Harpsichord Trio	VARI3	Strings Trio	VARI3	Orchestra Hit
CLAVI		VIOLIN		WOOD BASS	
NORMAL	Clavi	NORMAL	Violin	NORMAL	Wood Bass
VARI1	Clavi Echo	VARI1	Violin Country	VARI1	Wood Bass/Piano
VARI2	Sustained Clavi	VARI2	Violin Duet	VARI2	Wood Bass/Electric Organ
VARI3	Clavi Block	VARI3	Violin Trio	VARI3	Wood Bass/Jazz Guitar
ORGAN		VIBRAPHONE		E BASS	
NORMAL	Pipe Organ	NORMAL	Vibraphone	NORMAL	Electric Bass
VARI1	Electric Organ	VARI1	Sustained Vibraphone	VARI1	Mute Bass
VARI2	Electric Organ Trio	VARI2	Electric Piano & Vibraphone	VARI2	Slap Bass
VARI3	Electric Organ Block	VARI3	Vibraphone Block	VARI3	Synth Bass
GUITAR		MARIMBA		PERCUSSION	
NORMAL	Folk Guitar	NORMAL	Marimba	NORMAL	Percussion
VARI1	Folk Guitar Echo	VARI1	Marimba Echo	VARI1	Percussion Echo
VARI2	Gut Guitar	VARI2	Marimba Trio	VARI2	Percussion W/Pitch
VARI3	Gut Guitar Echo	VARI3	Marimba Block	VARI3	Percussion W/Pitch Echo
E GUITAR		FLUTE			
NORMAL	Electric Guitar	NORMAL	Flute		
VARI1	Electric Guitar Echo	VARI1	Flute Duet		
VARI2	Distortion Guitar	VARI2	Piccolo		
VARI3	Distortion Guitar Dual	VARI3	Panflute		
JAZZ GUITAR		SAXOPHONE			
NORMAL	Jazz Guitar	NORMAL	Tenor Sax		
VARI1	Jazz Guitar Octave	VARI1	Alto Sax		
VARI2	Mute Guitar	VARI2	Clarinet		
VARI3	Mute Guitar Echo	VARI3	Clarinet Trio		

- Dual voices have two voices layered together for ensemble sounds.
- Split voices have two voices. Each is played from a different range of the keyboard (F#3 and below for the lower voice, G3 and above the upper).
- Harmony Voice (Country, Trio, Block, Duet) have an additional one-, two-, three- note harmony added to the original monophonic voice. If several notes are played together, only the last note played will be heard. When a Song or Jam Track does not play back, the basic key for the harmony is always C. When a Song or Jam Track plays back, the harmony changes according to the chord progression of the Song or Jam Track.
- Sustain voices extend the sound by adding a natural, slow release.
- Echo voices have an echo effect that adds delayed repeats to the original voice.

Power Requirements

Your PortaSound can run either on batteries (sold separately) or on normal household current by using the optional Yamaha PA-1/1B/3 Power Adaptor.

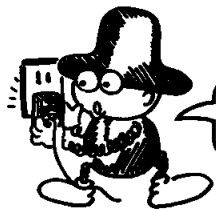

Using an AC Power Adaptor

To connect your PortaSound to a wall socket, you will need the optionally available Yamaha PA-1/1B/3 Power Adaptor. Use of other AC adaptors could result in damage to the instrument, so be sure to ask for the right kind. Plug the adaptor into a convenient wall outlet and its connector into the DC 10-12V IN jack on the back of your PortaSound.



Using Batteries

Inserting Batteries

Turn the instrument upside-down and remove the battery compartment lid. Insert six 1.5-volt size "AA" batteries as shown in the illustration, making sure that the positive and negative terminals are properly aligned. Replace the lid.

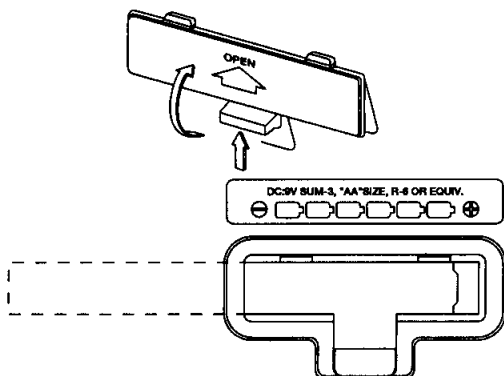

When the Batteries Run Down

When the batteries run low and the battery voltage drops below a certain level, the PortaSound may not sound or function properly. As soon as this happens, replace them with a complete set of six new batteries. Never mix old and new or different types of batteries (e.g., alkaline and manganese).

Accessory Jacks

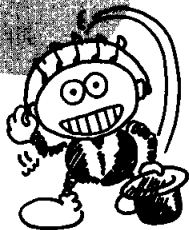

Using Headphones

For private practicing and playing without disturbing others, connect a set of stereo headphones to the rear panel HEADPHONES/AUX OUT jack. Sound from the built-in speaker system is automatically cut off when you insert a head-phone plug into this jack.



Connecting a Keyboard Amplifier or Stereo System

After making sure the PortaSound and any external devices are turned off, connect one end of a stereo audio cable to the LINE IN or AUX IN jack(s) of the other device and the other end to the HEADPHONES/AUX OUT jack of the PortaSound.

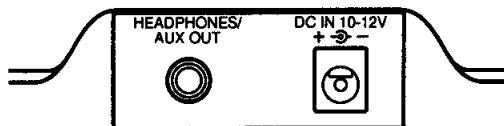

1

2

3

4

5

6

7

8

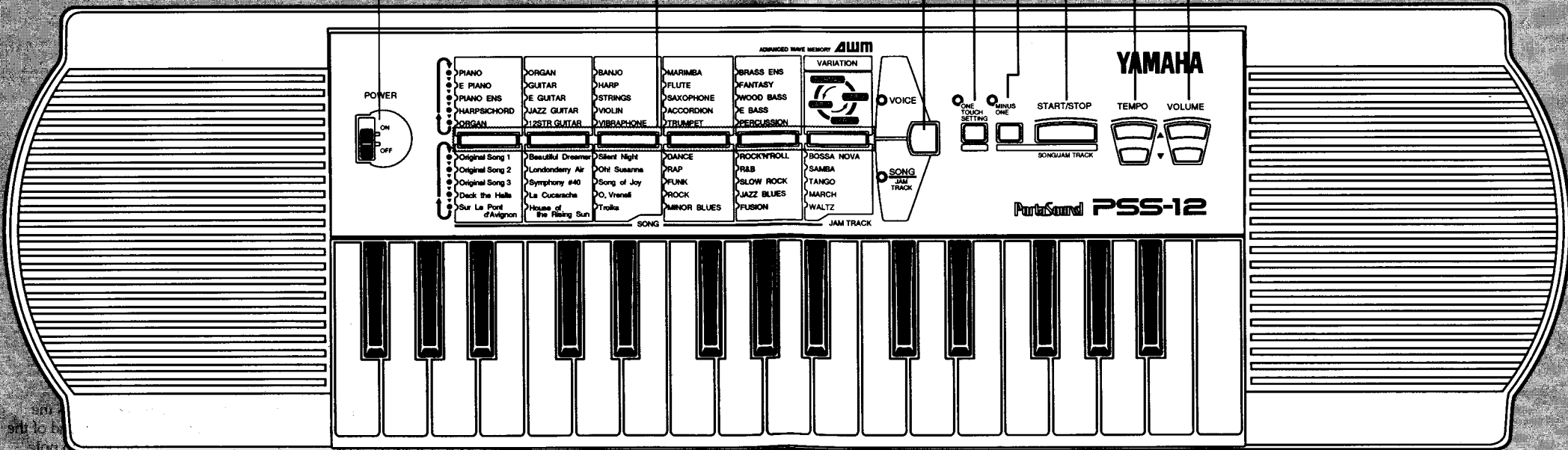

POWER



- | | | | | |
|-------------|---------------|------------|-----------|------------|
| PIANO | ORGAN | BANJO | MARIMBA | BRASS ENS |
| DE PIANO | GUITAR | HARP | FLUTE | FANTASY |
| PIANO ENS | DE GUITAR | STRINGS | SAXOPHONE | WOOD BASS |
| HARPSICHORD | JAZZ GUITAR | VIOLIN | ACCORDION | DE BASS |
| ORGAN | ELECTR GUITAR | VIBRAPHONE | TRUMPET | PERCUSSION |

- | | | | | | |
|------------------------|------------------------|--------------|-------------|-------------|------------|
| Original Song 1 | Beautiful Dreamer | Silent Night | DANCE | ROCK'N'ROLL | BOSSA NOVA |
| Original Song 2 | Londonderry Air | Oht Susanna | RAP | R&B | SAMBA |
| Original Song 3 | Symphony #40 | Song of Joy | FUNK | SLOW ROCK | TANGO |
| Deck the Halls | La Cucaracha | O, Virelai | ROCK | JAZZ BLUES | MARCH |
| Sur Le Front d'Avignon | Home of the Rising Sun | Trotta | MINOR BLUES | FUSION | WALTZ |

ADVANCED WAVE MEMORY **AWM**

VARIATION



VOICE

SONG

JAM TRACK

YAMAHA



SONG/JAM TRACK

PortaSound **PSS-12**

Playing Your PortaSound

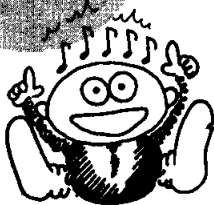

Turning on the Power

Set the *POWER ON/OFF* switch ❶ to ON, to turn on the power of the PortaSound. When the power is on, the Voice mode is automatically selected and the PIANO Voice is called up.

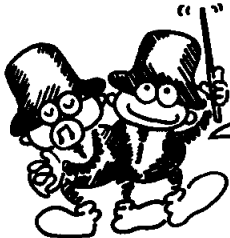

Selecting a Mode

Your PortaSound has two different operating modes: Voice and Song. Switch between the two modes by pressing the *VOICE/SONG* Mode button ❸. (The LED of the selected mode lights.)

In the Voice mode, you can select and play a Voice. In the Song mode, you can select and play either a Song or a Jam Track pattern.



Selecting and Playing Voices in the Voice Mode

The PortaSound features 25 different instrument Voices, each of them with three additional Variations. Depending on the Voice selected, the Variations apply special harmonies, sustain or echo effects to the Voice.

- 1 Make sure that the Voice mode is selected. Press the VOICE/SONG Mode button ③ until the green VOICE LED lights.**
- 2 Select the desired Voice with the VOICE/SONG Select buttons ②.** Press the button corresponding to the appropriate section of Voices. For example, to select the ORGAN Voice, press VOICE/SONG Select button below the section containing “ORGAN” (the second button from the left).
To select other Voices in the same section, press the VOICE/SONG Select button of that section repeatedly until you hear the sound of the desired Voice. (Each press of the button plays a single note of the selected Voice, so that you can “audition” the Voice.)
- 3 To select a Variation of the Voice, press the VARIATION button (the VOICE/SONG Select button on the far right, in the VARIATION section).**

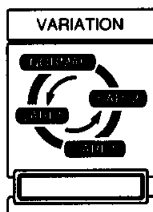

Each press of the button cycles through the Normal Voice and its Variations (1, 2 and 3). As with Voice selection, each press of the button plays a note, letting you “audition” the Variations.

Percussion Assign List (PERCUSSION Voice)

The PERCUSSION Voice lets you play drum and percussion sounds from the keyboard. The specific sounds are assigned to the keyboard as shown below.

Normal / Variation 1

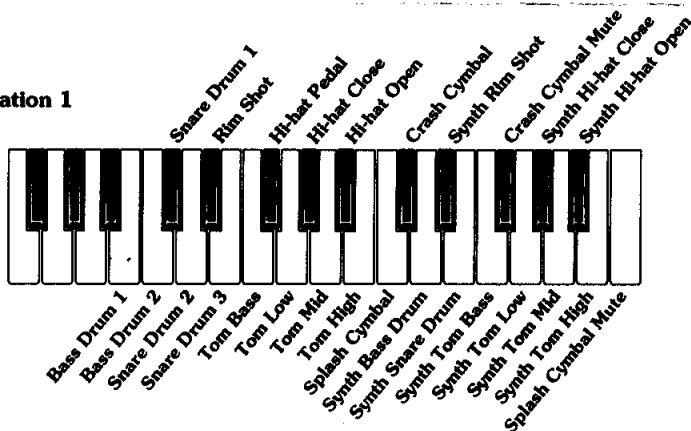

Variation 2 / Variation 3

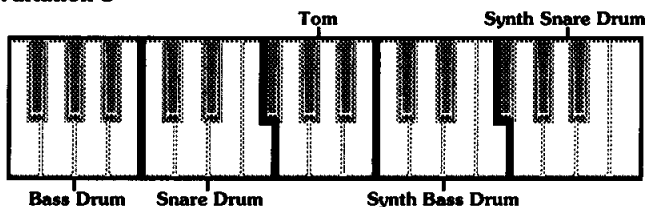

Adjusting the Volume

Adjust the volume of the Voice by using the *VOLUME buttons* 8. Press the ▲ button to increase the volume or the ▼ button to decrease it; hold down the appropriate button continuously to increase or decrease it.

Pressing the buttons also produces a “click” sound to indicate whether you are increasing the volume (high click) or decreasing it (low click).

You can restore the original default volume setting by pressing both *VOLUME* buttons simultaneously.



NOTE The PortaSound is polyphonic up to a maximum of 12 notes. (Depending on the Voice selected, fewer notes may be available.) This includes not only the Voices played from the keyboard, but also the notes in a Song or Jam Track pattern. Thus, if you play too many notes at one time, some may not sound and/or others may be cancelled. (Refer to the Voice List at the end of this manual.)



Selecting and Playing Songs or Jam Tracks in the Song Mode

A variety of Songs and special Jam Tracks have been recorded to your PortaSound to give you a taste of what you can do with the instrument. The Songs are generally for your listening enjoyment; however, you can also play along with them on the keyboard. Also, by using the Minus One function, you can “mute” the original melody and play it manually on the keyboard yourself. The Jam Track patterns in this mode let you “jam” or play along with a variety of dynamic rhythm styles and chord changes.

To select and play one of the Songs or Jam Tracks:

1 Make sure that the Song mode is selected. Press the **VOICE/SONG Mode button** ③ until the red **SONG LED** lights.

2 Select the desired Song or Jam Track with the **VOICE/SONG Select buttons** ②.

Press the button corresponding to the appropriate section. For example, to select the Song, “Beautiful Dreamer,” press **VOICE/SONG Select** button below the section containing “Beautiful Dreamer” (the second button from the left).

Playback of the Song or Jam Track starts as soon as the button is pressed. Select other Songs/Jam Tracks in the same section by pressing the **VOICE/SONG Select** button of that section repeatedly until you hear the desired selection.

Note that the **SONG LED** flashes in time with the music.

3 Adjust the Volume of the Song or Jam Track by using the **VOLUME buttons** ④.

(See “Adjusting the Volume” above for more information.)

4 You can also adjust the playback speed with the **TEMPO buttons** ⑦.

Press the ▲ button to increase the tempo or the ▼ button to decrease it; hold down the appropriate button to continuously increase or decrease it. The tempo range is from 40 to 240 bpm (beats per minute), and is adjustable in steps of 4 bpm.

Pressing the buttons also produces a “click” sound to indicate whether you are increasing the tempo (high click) or decreasing it (low click).

You can restore the original default tempo setting of the Song or Jam Track by pressing both **TEMPO** buttons simultaneously.

5 To stop playback, press the **START/STOP** button 6.

If playback is not stopped, all Songs play back repeatedly in succession, indefinitely. (However, if Minus One is on, only the selected Song repeatedly plays back.) If a Jam Track pattern is selected, only the selected pattern repeats indefinitely.



Using the Minus One Feature

Minus One, as its name implies, takes away the melody part of the Song, allowing you to play that part yourself. You can turn Minus One on before starting a Song, or do it even while a Song is playing. When used with one of the Jam Track patterns, Minus One cancels all bass and chord accompaniment, leaving only the basic rhythm of the Jam Track.

To use the Minus One function with the selected Song or Jam Track, press the **MINUS ONE** button 5 (either before starting playback or during playback). (The LED above the button lights.)



Using the One Touch Setting Feature

The One Touch Setting function works with the Minus One function and automatically selects an appropriate Voice for playing the melody along with the Song you select. One Touch Setting works the same way with Jam Track, automatically selecting an appropriate Voice.

To turn on the One Touch Setting function, press the **ONE TOUCH SETTING** button 4. (The LED above the button lights.)

To turn the function off, press the button again.



Keep in mind that even with the One Touch Setting function on, there are some Songs and Jam Track patterns which change the selected Voice in the middle of the Song or pattern.



Specifications

KEYBOARD	Number of Keys: 32, Key Size: Mini, Register: F2 - C5
VOICE	Tone Generation: AWM Number of Voices: 100 (25 x 4 Variations) Polyphony (Maximum): 12 notes
SONG/JAM TRACK	Songs: 15, Jam Track Patterns: 15, Minus One: Yes, One Touch Setting: Yes
CONTROLS	POWER ON/OFF, VOICE, SONG, ONE TOUCH SETTING, MINUS ONE, START/STOP, TEMPO, VOLUME
OTHER TERMINALS, FITTINGS	DC IN, HEADPHONES/AUX OUT
AMPLIFIERS	1.4 W + 1.4 W (using Power Adaptor/batteries)
SPEAKERS	7.7 cm x 2, 4 Ω
POWER CONSUMPTION	6.3 W (using Power Adaptor PA-3)
RATED POWER SUPPLY	DC 10-12 V: 6 "AA" size/R-6/SUM-3 (1.5 V) batteries, or PA-1/1B/3 Power Adaptor
DIMENSIONS (W x D x H)	634mm x 179mm x 65mm (25" x 7" x 2-1/2")
WEIGHT	1.26kg (2 lbs., 12oz.)
CASING	Polystyrene
OPTIONAL ACCESSORIES	HPE-3/Headphones, PA-1/1B/3 Power Adaptors

Specifications are subject to change without notice.

Troubleshooting

Problem	Possible Cause and Solution
When the PortaSound is turned on or off, a buzzing sound is temporarily produced.	This is normal and indicates that power is flowing into the PortaSound.
The sound of the voices or rhythms seems unusual or strange.	The battery power is too low. Replace the batteries.
Not all notes are heard when playing a number of notes simultaneously.	Too many keys are pressed at the same time. The PortaSound is polyphonic up to a maximum of 12 notes. (See the note about polyphony in the section "Selecting and Playing Voices in the Voice Mode".)
The sound of the Voice changes from note to note.	The AWM tone generation method uses multiple recordings (samples) of an instrument across the range of the keyboard; thus, the actual sound of the Voice may be slightly different from note to note.

SPECIAL MESSAGE SECTION

This product utilizes batteries or an external power supply (adapter). DO NOT connect this product to any power supply or adapter other than one described in the manual, on the name plate, or specifically recommended by Yamaha.

This product should be used only with the components supplied or; a cart, rack, or stand that is recommended by Yamaha. If a cart, etc., is used, please observe all safety markings and instructions that accompany the accessory product.

SPECIFICATIONS SUBJECT TO CHANGE:

The information contained in this manual is believed to be correct at the time of printing. However, Yamaha reserves the right to change or modify any of the specifications without notice or obligation to update existing units.

This product, either alone or in combination with an amplifier and headphones or speaker/s, may be capable of producing sound levels that could cause permanent hearing loss. DO NOT operate for long periods of time at a high volume level or at a level that is uncomfortable. If you experience any hearing loss or ringing in the ears, you should consult an audiologist.

IMPORTANT: The louder the sound, the shorter the time period before damage occurs.

NOTICE:

Service charges incurred due to a lack of knowledge relating to how a function or effect works (when the unit is operating as designed) are not covered by the manufacturer's warranty, and are therefore the owners responsibility. Please study this manual carefully and consult your dealer before requesting service.

ENVIRONMENTAL ISSUES:

Yamaha strives to produce products that are both user safe and environmentally friendly. We sincerely believe that our products and the production methods used to produce them, meet these goals. In keeping with both the letter and the spirit of the law, we want you to be aware of the following:

Battery Notice: This product MAY contain a small non-rechargeable battery which (if applicable) is soldered in place. The average life span of this type of battery is approximately five years. When replacement becomes necessary, contact a qualified service representative to perform the replacement.

This product may also use "household" type batteries. Some of these may be rechargeable. Make sure that the battery being charged is a rechargeable type and that the charger is intended for the battery being charged.

When installing batteries, do not mix batteries with new, or with batteries of a different type. Batteries MUST be installed correctly. Mismatches or incorrect installation may result in overheating and battery case rupture.

Warning: Do not attempt to disassemble, or incinerate any battery. Keep all batteries away from children. Dispose of used batteries promptly and as regulated by the laws in your area. Note: Check with any retailer of household type batteries in your area for battery disposal information.

Disposal Notice: Should this product become damaged beyond repair, or for some reason its useful life is considered to be at an end, please observe all local, state, and federal regulations that relate to the disposal of products that contain lead, batteries, plastics, etc. If your dealer is unable to assist you, please contact Yamaha directly.

NAME PLATE LOCATION:

The name plate is located on the bottom of the product. The model number, serial number, power requirements, etc., are located on this plate. You should record the model number, serial number, and the date of purchase in the spaces provided below and retain this manual as a permanent record of your purchase.

Model

Serial No.

Purchase Date

PLEASE KEEP THIS MANUAL

FCC INFORMATION (U.S.A.)

IMPORTANT NOTICE: DO NOT MODIFY THIS UNIT!

This product, when installed as indicated in the instructions contained in this manual, meets FCC requirements. Modifications not expressly approved by Yamaha may void your authority, granted by the FCC, to use the product.

IMPORTANT: When connecting this product to accessories and/or another product use only high quality shielded cables. Cable/s supplied with this product MUST be used. Follow all installation instructions. Failure to follow instructions could void your FCC authorization to use this product in the USA.

NOTE: This product has been tested and found to comply with the requirements listed in FCC Regulations, Part 15 for Class "B" digital devices. Compliance with these requirements provides a reasonable level of assurance that your use of this product in a residential environment will not result in harmful interference with other electronic devices. This equipment generates/uses radio frequencies and, if not installed and used according to the instructions found in the users manual, may cause interference harmful to the operation of other electronic devices. Compliance with FCC regulations does not guarantee that interference will not occur in all installations. If this product is found to be the source of interference, which can be determined by turning the unit "OFF" and "ON", please try to eliminate the problem by using one of the following measures:

- Relocate either this product or the device that is being affected by the interference.
- Utilize power outlets that are on different branch(circuit breaker or fuse) circuits or install AC line filter/s.
- In the case of radio or TV interference, relocate/reorient the antenna. If the antenna lead-in is 300 ohm ribbon lead, change the lead-in to co-axial type cable.

If these corrective measures do not produce satisfactory results, please contact the local retailer authorized to distribute this type of product. If you can not locate the appropriate retailer, please contact Yamaha Corporation of America, Electronic Service Division, 6600 Orangeforpe Ave, Buena Park, CA90620

For details of products, please contact your nearest Yamaha or the authorized distributor listed below.

Pour plus de détails sur les produits, veuillez-vous adresser à Yamaha ou au distributeur le plus proche de vous figurant dans la liste suivante.

Die Einzelheiten zu Produkten sind bei Ihrer unten aufgeführten Niederlassung und bei Yamaha Vertragshändlern in den jeweiligen Bestimmungsländern erhältlich.

Para detalles sobre productos, contacte su tienda Yamaha más cercana o el distribuidor autorizado que se lista debajo.

NORTH AMERICA

CANADA

Yamaha Canada Music Ltd.
135 Milner Avenue, Scarborough, Ontario,
M1S 3R1, Canada
Tel: 416-298-1311

U.S.A.

Yamaha Corporation of America
6600 Orangehorpe Ave., Buena Park, Calif. 90620,
U.S.A.
~Tel: 714-522-9011

MIDDLE & SOUTH AMERICA

MEXICO

**Yamaha De Mexico S.A. De C.V.,
Departamento de ventas**
Javier Rojo Gomez No.149, Col. Gpe Del
Moral, Deleg. Iztapalapa, 09300 Mexico, D.F.
Tel: 686-00-33

BRASIL

Yamaha Musical Do Brasil LTDA.
Ave. Reboucas 2636, São Paulo, Brasil
Tel: 011-853-1377

PANAMA

Yamaha De Panama S.A.
Edificio Interseco, Calle Elvira Mendez no.10, Piso
3, Oficina #105, Ciudad de Panama, Panama
Tel: 507-69-5311

OTHER LATIN AMERICAN COUNTRIES AND CARIBBEAN COUNTRIES

Yamaha Music Latin America Corp.
6101 Blue Lagoon Drive, Miami, Florida 33126,
U.S.A.
Tel: 305-261-4111

EUROPE

THE UNITED KINGDOM

Yamaha-Kemble Music(U.K.) Ltd.
Sherbourne Drive, Tilbrook, Milton Keynes,
MK7 8BL England
Tel: 0908-366700

IRELAND

Danfay Ltd.
61D, Sallynoggin Road, Dun Laoghaire, Co. Dublin
Tel: 01-2859177

GERMANY/SWITZERLAND

Yamaha Europa GmbH.
Siemensstraße 22-34, D-2084 Rellingen, F.R. of
Germany
Tel: 04101-3030

AUSTRIA/HUNGARY/SLOVENIA/ ROMANIA/BULGARIA

Yamaha Music Austria Ges m b H.
Schleiergasse 20, A-1100 Wien Austria
Tel: 0222-60203900

THE NETHERLANDS

**Yamaha Music Benelux B.V.,
Verkoop Administratie**
Kanaalweg 18C, 3526 KL Utrecht, The Netherlands
Tel: 030-828411

BELGIUM/LUXEMBOURG

**Yamaha Music Benelux B.V.,
Brussels-office**
Keibergh Imperiastraat 8, 1930 Zaventem, Belgium
Tel: 02-7258220

FRANCE

**Yamaha Musique France, Division
Instruments Electroniques et de Scène**
BP 70-77312 Marne-la-Vallée Cedex 2, France
Tel: 01-64-61-4000

ITALY

**Yamaha Musica Italia S.P.A.,
Home Keyboard Division**
Viale Italia 88, 20020 Lainate(Milano), Italy
Tel: 02-935-771

SPAIN

Yamaha-Hazen Electronica Musical, S.A.
Jorge Juan 30, 28001, Madrid, Spain
Tel: 91-577-7270

PORTUGAL

Valentim de Carvalho CI SA
Estrada de Porto Salvo, Paço de Arcos 2780 Oeiras,
Portugal
Tel: 01-443-3398/4030/1823

GREECE

Phillippe Nakas S.A.
Navarinou Street 13, P.Code 10680, Athens, Greece
Tel: 01-364-7111

SWEDEN

Yamaha Scandinavia AB
J. A. Wettergrens gata 1, Box 30053, 400 43
Göteborg, Sweden
Tel: 031-496090

DENMARK

Yamaha Scandinavia Filial Denmark
Generatorvej 8B 2730 Herlev, Denmark
Tel: 44 92 49 00

FINLAND

Fazer Music Inc.
Aleksanterinkatu 11, SF 00100 Helsinki, Finland
Tel: 0435 011

NORWAY

Narud Yamaha AS
Østerdalen 29, 1345 Østertås
Tel: 02-24 47 90

ICELAND

Páll H. Pálsson
P.O. Box 85, 121 Reykjavik, Iceland
Tel: 01-19440

OTHER EUROPEAN COUNTRIES

Yamaha Europa GmbH.
Siemensstraße 22-34, D-2084 Rellingen, F.R. of
Germany
Tel: 04101-3030

AFRICA

**Yamaha Corporation,
International Marketing Division**
Nakazawa-cho 10-1, Hamamatsu, Japan 430
Tel: 053-460-2312

MIDDLE EAST

TURKEY/CYPRUS

Yamaha Musique France, Division Export
BP70-77312 Marne-la-Vallée Cedex 2, France
Tel: 01-64-61-4000

OTHER COUNTRIES

**Yamaha Corporation,
International Marketing Division**
Nakazawa-cho 10-1, Hamamatsu, Japan 430
Tel: 053-460-2312

ASIA

HONG KONG

Tom Lee Music Co., Ltd.
11/F, Silvercord Tower 1, 30 Canton Road,
Tsimshatsui, Kowloon, Hong Kong
Tel: 730-1098

INDONESIA

**PT. Yamaha Music Indonesia (Distributor)
PT. Nusantara**
Gedung Yamaha Music Center, Jalan Jend. Gatot
Subroto Kav. 4, Jakarta 12930, Indonesia
Tel: 21-520-2577

KOREA

Cosmos Corporation
#131-31, Neung-Dong, Sungdong-Ku, Seoul
Korea
Tel: 02-466-0021-5

MALAYSIA

Yamaha Music Malaysia Sdn., Bhd.
16-28, Jalan SS 2/72, Petaling Jaya, Selangor,
Malaysia
Tel: 3-717-8977

PHILIPPINES

Yupangco Music Corporation
339 Gil J. Puyat Avenue, P.O. Box 885 MCPO,
Makati, Metro Manila, Philippines
Tel: 819-7551

SINGAPORE

Yamaha Music Asia Pte., Ltd.
Blk 17A Teo Payoh #01-190 Lorong 7
Singapore 1231
Tel: 354-0133

TAIWAN

Kung Hsue She Trading Co., Ltd.
No. 322, Section 1, Fu Hsing S. Road,
Taipei 106, Taiwan, R.O.C.
Tel: 02-709-1266

THAILAND

Siam Music Yamaha Co., Ltd.
865 Phornphrapha Building, Rama I Road,
Patumwan, Bangkok 10330, Thailand
Tel: 2-215-3443

THE PEOPLE'S REPUBLIC OF CHINA AND OTHER ASIAN COUNTRIES

**Yamaha Corporation,
International Marketing Division**
Nakazawa-cho 10-1, Hamamatsu, Japan 430
Tel: 053-460-2317

OCEANIA

AUSTRALIA

Yamaha Music Australia Pty. Ltd.
17-33 Market Street, South Melbourne, Vic. 3205,
Australia
Tel: 3-699-2388

NEW ZEALAND

Music Houses of N.Z. Ltd.
146/148 Captain Springs Road, Te Papapa,
Auckland, New Zealand
Tel: 9-634-0099

COUNTRIES AND TRUST TERRITORIES IN PACIFIC OCEAN

**Yamaha Corporation,
International Marketing Division** *
Nakazawa-cho 10-1, Hamamatsu, Japan 430
Tel: 053-460-2317

YAMAHA
YAMAHA CORPORATION

HEAD OFFICE Yamaha Corporation, Electronic Musical Instrument Division
Nakazawa-cho 10-1, Hamamatsu, Japan 430
Tel: 053-460-3273