

# AVANT GRAND

## N3X

Owner's Manual  
Mode d'emploi  
Manual de instrucciones

### **IMPORTANT – Check your power supply –**

Make sure that your local AC mains voltage matches the voltage specified on the name plate on the bottom panel. In some areas a voltage selector may be provided on the bottom of the main keyboard unit near the power cord. Make sure that the voltage selector is set for the voltage in your area. The voltage selector is set at 240V when the unit is initially shipped. To change the setting use a "minus" screwdriver to rotate the selector dial so that the correct voltage appears next to the pointer on the panel.

Before using this instrument, be sure to read "PRECAUTIONS" on pages 5–6.

When assembling the unit, consult a qualified AvantGrand dealer. (Refer to the assembly instructions at the end of this manual.)

### **IMPORTANT – Vérifiez votre source d'alimentation –**

Vérifiez que la tension de l'alimentation secteur correspond à celle spécifiée sur la plaque du fabricant, située sur le panneau inférieur. Les instruments vendus dans certaines régions disposent d'un sélecteur de tension sur la partie inférieure du clavier de l'unité principale, à côté du cordon d'alimentation. Assurez-vous que le sélecteur de tension est réglé sur la tension utilisée dans votre région. À sa sortie d'usine, le sélecteur est réglé sur 240 V. Pour modifier ce réglage, utilisez un tournevis plat et faites tourner le cadran du sélecteur jusqu'à ce que la valeur correcte apparaisse à côté de l'indicateur sur le panneau.

Avant d'utiliser cet instrument, lisez attentivement la section « PRÉCAUTIONS D'USAGE » aux pages 5-6.

Lors du montage de l'unité, contactez un revendeur AvantGrand agréé. (Reportez-vous aux instructions de montage figurant à la fin de ce manuel.)

### **IMPORTANTE – Compruebe la fuente de alimentación –**

Asegúrese de que la tensión de la red eléctrica local de CA coincide con la tensión especificada en la placa situada en el panel inferior. Es posible que en algunas zonas se suministre un selector de tensión en la parte inferior de la unidad del teclado principal, junto al cable de alimentación. Asegúrese de que este selector está ajustado según la tensión de la zona. El selector de tensión viene ajustado de fábrica para 240 V. Para cambiar el ajuste, utilice un destornillador de punta normal para girar el selector hasta que la tensión correcta aparezca al lado del puntero del panel.

Antes de utilizar el instrumento, lea la sección "PRECAUCIONES", en las páginas 5-6.

Al montar la unidad, consulte con un concesionario cualificado de Avant Grand (consulte las instrucciones de montaje al final de este manual).

ENGLISH

FRANÇAIS

ESPAÑOL

EN  
FR  
ES

# SPECIAL MESSAGE SECTION

**PRODUCT SAFETY MARKINGS:** Yamaha electronic products may have either labels similar to the graphics shown below or molded/stamped facsimiles of these graphics on the enclosure. The explanation of these graphics appears on this page. Please observe all cautions indicated on this page and those indicated in the safety instruction section.

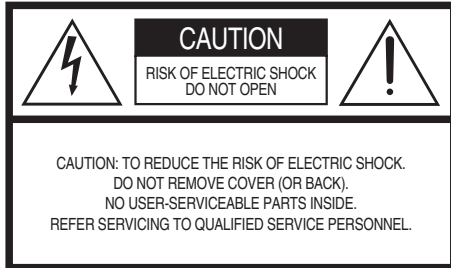

See bottom of Keyboard enclosure for graphic symbol markings.



The exclamation point within the equilateral triangle is intended to alert the user to the presence of important operating and maintenance (servicing) instructions in the literature accompanying the product.



The lightning flash with arrowhead symbol, within the equilateral triangle, is intended to alert the user to the presence of uninsulated “dangerous voltage” within the product’s enclosure that may be of sufficient magnitude to constitute a risk of electrical shock.

**IMPORTANT NOTICE:** All Yamaha electronic products are tested and approved by an independent safety testing laboratory in order that you may be sure that when it is properly installed and used in its normal and customary manner, all foreseeable risks have been eliminated. **DO NOT** modify this unit or commission others to do so unless specifically authorized by Yamaha. Product performance and/or safety standards may be diminished. Claims filed under the expressed warranty may be denied if the unit is/has been modified. Implied warranties may also be affected.

**SPECIFICATIONS SUBJECT TO CHANGE:** The information contained in this manual is believed to be correct at the time of printing. However, Yamaha reserves the right to change or modify any of the specifications without notice or obligation to update existing units.

**ENVIRONMENTAL ISSUES:** Yamaha strives to produce products that are both user safe and environmentally friendly. We sincerely believe that our products and the production methods used to produce them, meet these goals. In keeping with both the letter and the spirit of the law, we want you to be aware of the following:

**Battery Notice:** This product MAY contain a small non-rechargeable battery which (if applicable) is soldered in place. The average life span of this type of battery is approximately five years. When replacement becomes necessary, contact a qualified service representative to perform the replacement.

**Warning:** Do not attempt to recharge, disassemble, or incinerate this type of battery. Keep all batteries away from children. Dispose of used batteries promptly and as regulated by applicable laws. Note: In some areas, the servicer is required by law to return the defective parts. However, you do have the option of having the servicer dispose of these parts for you.

**Disposal Notice:** Should this product become damaged beyond repair, or for some reason its useful life is considered to be at an end, please observe all local, state, and federal regulations that relate to the disposal of products that contain lead, batteries, plastics, etc.

**NOTICE:** Service charges incurred due to lack of knowledge relating to how a function or effect works (when the unit is operating as designed) are not covered by the manufacturer’s warranty, and are therefore the owners responsibility. Please study this manual carefully and consult your dealer before requesting service.

**NAME PLATE LOCATION:** The graphic below indicates the location of the name plate. The model number, serial number, power requirements, etc., are located on this plate. You should record the model number, serial number, and the date of purchase in the spaces provided below and retain this manual as a permanent record of your purchase.

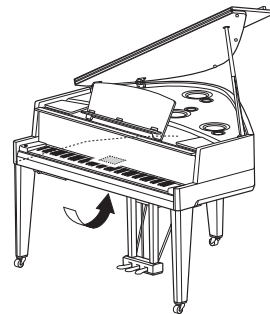

**Model** \_\_\_\_\_

**Serial No.** \_\_\_\_\_

**Purchase Date** \_\_\_\_\_

## FCC INFORMATION (U.S.A.)

### 1. IMPORTANT NOTICE: DO NOT MODIFY THIS UNIT!

This product, when installed as indicated in the instructions contained in this manual, meets FCC requirements. Modifications not expressly approved by Yamaha may void your authority, granted by the FCC, to use the product.

### 2. IMPORTANT:

When connecting this product to accessories and/or another product use only high quality shielded cables. Cable/s supplied with this product MUST be used. Follow all installation instructions. Failure to follow instructions could void your FCC authorization to use this product in the USA.

### 3. NOTE:

This product has been tested and found to comply with the requirements listed in FCC Regulations, Part 15 for Class "B" digital devices. Compliance with these requirements provides a reasonable level of assurance that your use of this product in a residential environment will not result in harmful interference with other electronic devices. This equipment generates/uses radio frequencies and, if not installed and used according to the instructions found in the users manual, may cause interference harmful to the operation of other electronic devices. Compliance with FCC regulations does not guarantee

that interference will not occur in all installations. If this product is found to be the source of interference, which can be determined by turning the unit "OFF" and "ON," please try to eliminate the problem by using one of the following measures:

Relocate either this product or the device that is being affected by the interference.

Utilize power outlets that are on different branch (circuit breaker or fuse) circuits or install AC line filter/s.

In the case of radio or TV interference, relocate/reorient the antenna. If the antenna lead-in is 300 ohm ribbon lead, change the lead-in to co-axial type cable.

If these corrective measures do not produce satisfactory results, please contact the local retailer authorized to distribute this type of product. If you can not locate the appropriate retailer, please contact Yamaha Corporation of America, Electronic Service Division, 6600 Orangethorpe Ave, Buena Park, CA90620

The above statements apply ONLY to those products distributed by Yamaha Corporation of America or its subsidiaries.

\* This applies only to products distributed by YAMAHA CORPORATION OF AMERICA.

(class B)

### COMPLIANCE INFORMATION STATEMENT (DECLARATION OF CONFORMITY PROCEDURE)

Responsible Party : Yamaha Corporation of America  
Address : 6600 Orangethorpe Ave., Buena Park, Calif. 90620  
Telephone : 714-522-9011  
Type of Equipment : Hybrid Piano  
Model Name : N3X

This device complies with Part 15 of the FCC Rules.

Operation is subject to the following two conditions:

- 1) this device may not cause harmful interference, and
- 2) this device must accept any interference received including interference that may cause undesired operation.

See user manual instructions if interference to radio reception is suspected.

\* This applies only to products distributed by YAMAHA CORPORATION OF AMERICA.

(FCC DoC)

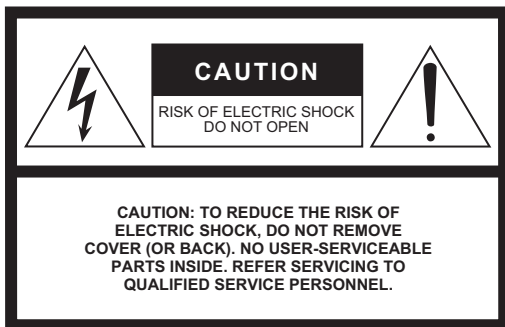

The above warning is located on the bottom of the unit.

## Explanation of Graphical Symbols



The lightning flash with arrowhead symbol within an equilateral triangle is intended to alert the user to the presence of uninsulated “dangerous voltage” within the product’s enclosure that may be of sufficient magnitude to constitute a risk of electric shock to persons.



The exclamation point within an equilateral triangle is intended to alert the user to the presence of important operating and maintenance (servicing) instructions in the literature accompanying the product.

# IMPORTANT SAFETY INSTRUCTIONS

- 1 Read these instructions.
- 2 Keep these instructions.
- 3 Heed all warnings.
- 4 Follow all instructions.
- 5 Do not use this apparatus near water.
- 6 Clean only with dry cloth.
- 7 Do not block any ventilation openings. Install in accordance with the manufacturer’s instructions.
- 8 Do not install near any heat sources such as radiators, heat registers, stoves, or other apparatus (including amplifiers) that produce heat.
- 9 Do not defeat the safety purpose of the polarized or grounding-type plug. A polarized plug has two blades with one wider than the other. A grounding type plug has two blades and a third grounding prong. The wide blade or the third prong are provided for your safety. If the provided plug does not fit into your outlet, consult an electrician for replacement of the obsolete outlet.
- 10 Protect the power cord from being walked on or pinched particularly at plugs, convenience receptacles, and the point where they exit from the apparatus.

- 11 Only use attachments/accessories specified by the manufacturer.
- 12 Use only with the cart, stand, tripod, bracket, or table specified by the manufacturer, or sold with the apparatus. When a cart is used, use caution when moving the cart/apparatus combination to avoid injury from tip-over.
- 13 Unplug this apparatus during lightning storms or when unused for long periods of time.
- 14 Refer all servicing to qualified service personnel. Servicing is required when the apparatus has been damaged in any way, such as power-supply cord or plug is damaged, liquid has been spilled or objects have fallen into the apparatus, the apparatus has been exposed to rain or moisture, does not operate normally, or has been dropped.



### WARNING

TO REDUCE THE RISK OF FIRE OR ELECTRIC SHOCK, DO NOT EXPOSE THIS APPARATUS TO RAIN OR MOISTURE.

(UL60065\_03)

# PRECAUTIONS

## PLEASE READ CAREFULLY BEFORE PROCEEDING

Please keep this manual in a safe and handy place for future reference.



### WARNING

Always follow the basic precautions listed below to avoid the possibility of serious injury or even death from electrical shock, short-circuiting, damages, fire or other hazards. These precautions include, but are not limited to, the following:

#### Power supply/Power cord

- Do not place the power cord near heat sources such as heaters or radiators. Also, do not excessively bend or otherwise damage the cord, or place heavy objects on it.
- Only use the voltage specified as correct for the instrument. The required voltage is printed on the name plate of the instrument.
- Use only the supplied power cord/plug.
- Check the electric plug periodically and remove any dirt or dust which may have accumulated on it.

#### Do not open

- This instrument contains no user-serviceable parts. Do not open the instrument or attempt to disassemble or modify the internal components in any way. If it should appear to be malfunctioning, discontinue use immediately and have it inspected by qualified Yamaha service personnel.

#### Water warning

- Do not expose the instrument to rain, use it near water or in damp or wet conditions, or place on it any containers (such as vases, bottles or glasses) containing liquids which might spill into any openings. If any liquid such as water seeps into the instrument, turn off the power immediately and unplug the power cord from the AC outlet. Then have the instrument inspected by qualified Yamaha service personnel.
- Never insert or remove an electric plug with wet hands.

#### Fire warning

- Do not put burning items, such as candles, on the unit. A burning item may fall over and cause a fire.

#### If you notice any abnormality

- When one of the following problems occur, immediately turn off the power switch and disconnect the electric plug from the outlet. Then have the device inspected by Yamaha service personnel.
  - The power cord or plug becomes frayed or damaged.
  - It emits unusual smells or smoke.
  - Some object has been dropped into the instrument.
  - There is a sudden loss of sound during use of the instrument.



### CAUTION

Always follow the basic precautions listed below to avoid the possibility of physical injury to you or others, or damage to the instrument or other property. These precautions include, but are not limited to, the following:

#### Power supply/Power cord

- Do not connect the instrument to an electrical outlet using a multiple-connector. Doing so can result in lower sound quality, or possibly cause overheating in the outlet.
- When removing the electric plug from the instrument or an outlet, always hold the plug itself and not the cord. Pulling by the cord can damage it.
- Remove the electric plug from the outlet when the instrument is not to be used for extended periods of time, or during electrical storms.

#### Assembly

- Read carefully the attached documentation explaining the assembly process. Failure to assemble the instrument in the proper sequence might result in damage to the instrument or even injury.

#### Location

- Do not place the instrument in an unstable position where it might accidentally fall over.
- Since this product is very heavy, make sure that a sufficient number of people are on hand to help, so you can lift and move it safely and easily. Attempting to lift or move the instrument by force may damage your back, result in other injury, or cause damage to the instrument itself.
- Before moving the instrument, remove all connected cables, to prevent damage to the cables or injury to anyone who might trip over them.
- When setting up the product, make sure that the AC outlet you are using is easily accessible. If some trouble or malfunction occurs, immediately turn off the power switch and disconnect the plug from the outlet. Even when the power switch is turned off, electricity is still flowing to the product at the minimum level. When you are not using the product for a long time, make sure to unplug the power cord from the wall AC outlet.

- Though the wooden parts of this instrument have been designed and produced with care concerning the environment and human health, in some rare instances customers may sense an unusual odor or develop irritation in the eyes, due to the coating material and adhesive.  
To avoid this, we recommend that you observe the following:
  1. Specially ventilate the room for several days after unpacking and installing this instrument, since it has been packed in airtight conditions in order to maintain quality during transportation.
  2. If the room housing the instrument is small, continue to ventilate it normally, either daily or periodically.
  3. If you have left the instrument in a closed room for a long time under high temperature, ventilate the room, then lower the temperature if possible, before using the instrument.

## Connections

- Before connecting the instrument to other electronic components, turn off the power for all components. Before turning the power on or off for all components, set all volume levels to minimum.
- Be sure to set the volumes of all components at their minimum levels and gradually raise the volume controls while playing the instrument to set the desired listening level.

## Handling caution

- Do not insert a finger or hand in any gaps on the fallboard or instrument. Also take care that the fallboard does not pinch your finger.
- Do not apply excessive force when closing the fallboard.  
A fallboard equipped with the SOFT-CLOSE™ mechanism closes the cover slowly. Applying excessive force to the fallboard when closing it could damage the SOFT-CLOSE™ mechanism, and possibly result in injury to your hands and fingers caught under the closing fallboard.

Yamaha cannot be held responsible for damage caused by improper use or modifications to the instrument, or data that is lost or destroyed.

Always turn the power off when the instrument is not in use.

## NOTICE

To avoid the possibility of malfunction/ damage to the product, damage to data, or damage to other property, follow the notices below.

### ■ Handling

- Do not use the instrument in the vicinity of a TV, radio, stereo equipment, mobile phone, or other electric devices. Otherwise, the instrument, TV, or radio may generate noise. When you use the instrument along with an application on your iPad, iPhone or iPod touch, we recommend that you set "Airplane Mode" to "ON" on that device in order to avoid noise caused by communication.
- Do not expose the instrument to excessive dust or vibrations, or extreme cold or heat (such as in direct sunlight, near a heater, or in a car during the day) to prevent the possibility of panel disfiguration, damage to the internal components or unstable operation. (Verified operating temperature range: 5° – 40°C, or 41° – 104°F.)
- Do not place vinyl, plastic or rubber objects on the instrument, since this might discolor the panel or keyboard.
- Bumping the surface of the instrument with metal, porcelain, or other hard objects can cause the finish to crack or peel. Use caution.

### ■ Maintenance

- When cleaning the instrument, use a soft and dry/slightly damp cloth. Do not use paint thinners, solvents, alcohol, cleaning fluids, or chemical-impregnated wiping cloths.
- Gently remove dust and dirt with a soft cloth. Do not wipe too hard since small particles of dirt can scratch the instrument's finish.
- During extreme changes in temperature or humidity, condensation may occur and water may collect on the surface of the instrument. If water is left, the wooden parts may absorb the water and be damaged. Make sure to wipe any water off immediately with a soft cloth.

### ■ Saving data

- Some of the data of this instrument (page 40) are retained when the power is turned off. However, the saved data may be lost due to some failure, an operation mistake, etc.
- The Song data saved to the internal memory of this instrument (page 34) are retained when the power is turned off. However, the saved data may be lost due to some failure, an operation mistake, etc. Save your important data onto USB flash drive/an external device such as a computer (pages 38, 43). Before using a USB flash drive, make sure to refer to page 36.
- To protect against data loss through USB flash drive damage, we recommend that you save your important data onto spare USB flash drive or an external device such as a computer as backup data.

- Never insert or drop paper, metallic, or other objects into the gaps on the fallboard, panel or keyboard. This could cause physical injury to you or others, damage to the instrument or other property, or operational failure.
- Do not rest your weight on, or place heavy objects on the instrument, and do not use excessive force on the buttons, switches or connectors.
- Do not use the instrument/device or headphones for a long period of time at a high or uncomfortable volume level, since this can cause permanent hearing loss. If you experience any hearing loss or ringing in the ears, consult a physician.

## Using the bench (If included)

- Do not place the bench in an unstable position where it might accidentally fall over.
- Do not play carelessly with or stand on the bench. Using it as a tool or stepladder or for any other purpose might result in accident or injury.
- Only one person should sit on the bench at a time, in order to prevent the possibility of accident or injury.
- For benches that can be adjusted, do not adjust the bench height while sitting on the bench, since this can cause excessive force to be imposed on the adjustment mechanism, possibly resulting in damage to the mechanism or even injury.
- If the bench screws become loose due to extensive long-term use, tighten them periodically using the specified tool in order to prevent the possibility of accident or injury.
- Keep special watch over any small children so that they don't fall off the rear of the bench. Since the bench does not have a backrest, unsupervised use may result in accident or injury.

## Information

### ■ About copyrights

- Copying of the commercially available musical data including but not limited to MIDI data and/or audio data is strictly prohibited except for your personal use.
- This product incorporates and bundles contents in which Yamaha owns copyrights or with respect to which Yamaha has license to use others' copyrights. Due to copyright laws and other relevant laws, you are NOT allowed to distribute media in which these contents are saved or recorded and remain virtually the same or very similar to those in the product.
  - \* The contents described above include a computer program, Accompaniment Style data, MIDI data, WAVE data, voice recording data, a score, score data, etc.
  - \* You are allowed to distribute medium in which your performance or music production using these contents is recorded, and the permission of Yamaha Corporation is not required in such cases.

### ■ About functions/data bundled with the instrument

- Some of the preset songs have been edited for length or arrangement, and may not be exactly the same as the original.

### ■ About this manual

- The illustrations and displays as shown in this manual are for instructional purposes only, and may appear somewhat different from those on your instrument.
- iPad, iPhone or iPod touch are trademarks of Apple Inc., registered in the U.S. and other countries.
- The company names and product names in this manual are the trademarks or registered trademarks of their respective companies.

### ■ Tuning

- Unlike an acoustic piano, this instrument does not need to be tuned by an expert (although the pitch can be user-adjusted to match other instruments). This is because the pitch of digital instruments is always maintained perfectly. However, if you feel there is something abnormal concerning the keyboard touch, contact your Yamaha dealer.

### Transporting / Placing

If you move to another location, transport the instrument horizontally. Do not lean it up against a wall or stand it up side down. Do not subject the instrument to excessive vibration or shock.

#### ⚠ CAUTION

**When moving the instrument, always hold the bottom of the main unit. Be sure not to hold the control panel located on the bottom left. Improper handling can result in damage to the instrument or personal injury.**

To enhance the safety and to protect the floor, we recommend to put the instrument on caster cups (for a grand piano).

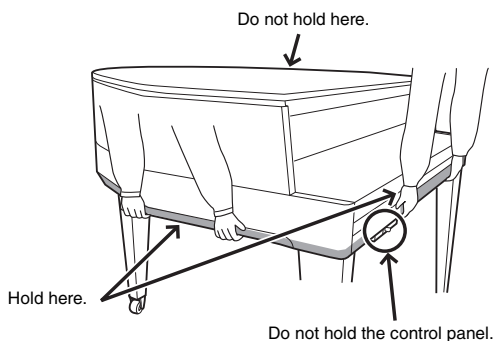

The model number, serial number, power requirements, etc., may be found on or near the name plate, which is at the bottom of the unit. You should note this serial number in the space provided below and retain this manual as a permanent record of your purchase to aid identification in the event of theft.

**Model No.**

---

**Serial No.**

---

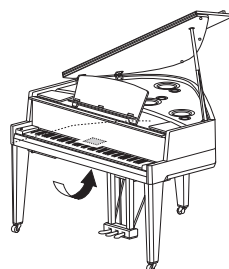

The name plate is located on the bottom of the unit.

(bottom\_en\_01)



Hybrid Piano

# AVANT GRAND N3X

**Combining over a century's experience in crafting world-class pianos with the latest in advanced technologies, Yamaha proudly introduces an instrument that is closer than ever to an actual acoustic grand piano—equipped with every essential element pianists demand.**

## **Authentic acoustic piano touch with special grand piano action and piano keyboard**

An actual acoustic grand piano has an unmistakable rich expressive quality, thanks to its finely nuanced touch and exceptional response. The remarkable AvantGrand N3X is the culmination of our many decades of expertise in crafting grand pianos, and offers the discerning player a specially-developed grand piano action featuring a configuration identical to the action of a real grand. The wood construction of the keyboard mirrors that of a grand piano, and features the material "Ivorite" for the white keys, giving them a texture amazingly close to that of natural ivory. The result is a wonderfully expressive keyboard that provides an authentic touch and feel. In addition to a hammer sensor, this instrument employs a non-contact key sensor that has no effect on the movement of the keys, yet accurately recognizes the player's pressure on the keyboard, timing, and the other delicate nuances that affect musical expression. Moreover, the TRS (Tactile Response System; page 25) realistically reproduces the resonance of the instrument, or the physical vibration that you feel from the keys or the pedals when you play a real grand piano.

## **Unique acoustic-sampling technique and speaker system**

One of the most important factors in the resonance of an actual grand piano is the soundboard. Aiming to effectively recreate that resonance, we sampled the grand piano voices utilizing Spatial Acoustic Sampling, which samples at not only the left and right, but also center and rear positions. In addition, the installed speakers mimic the positions in the grand piano from which the original samples were taken, and each of the speakers is equipped with its own dedicated amplifier. This Spatial Acoustic Speaker System ensures optimum sound at the player's position, providing more natural expression in the delicate nuances of each note. Moreover, a Soundboard Resonator, installed where the music rest would be when laid flat, enhances the expressive response of the sound, providing a realistic response—especially in the high notes.

## **The sound of several famous grand pianos in a single instrument** ➤➤ Page 20

The AvantGrand N3X puts the sounds of several different renowned grand pianos at your fingertips, including the CFX, Yamaha's flagship concert grand piano, a Bösendorfer\* Imperial, an instrument esteemed by pianists throughout its long history, and more—each with its own distinctive appeal and sonic characteristics. Simply select the particular piano sound desired, according to the music you intend to play or your personal preferences.

\* Bösendorfer is a subsidiary company of Yamaha.

## **Natural sound distance sensation for headphone play** ➤➤ Page 18

This instrument features a binaural sampling sound designed especially for use with headphones. Binaural sampling is a method which uses two microphones placed where the ears of a performer would be, and records that piano sound as it is. Listening to the sound created through this method with headphones gives the impression of being immersed in the sound, as if it was actually emanating from the piano.



# Table of Contents

<b>PRECAUTIONS</b> .....	<b>5</b>
--------------------------	----------

## Setting Up

Getting started playing your new Avant Grand!

<b>Panel Controls and Terminals</b> .....	<b>10</b>
<b>Playing the Keyboard</b> .....	<b>12</b>
Opening/Closing the Fallboard .....	12
Using the Music Rest .....	12
Opening/Closing the Lid .....	13
Power Supply .....	14
Turning the Power On/Off .....	15
Adjusting the Master Volume .....	17
Using Headphones .....	18
Using the Pedals .....	19

## Main Operations

This section explains how to make detailed settings for the instrument's various functions.

<b>Basic Operations and More</b> .....	<b>20</b>
Selecting a Voice .....	20
Listening to the Voice Demo Songs .....	21
Using the Metronome .....	22
Adjusting the Tempo .....	23
Changing the Touch Sensitivity .....	24
Adjusting the Strength of Vibration (TRS) .....	25
Playing the Realistic Resonance-enhanced VRM Voices .....	26
Enhancing the Sound with Reverb .....	27
Adjusting the Brightness of the Sound (Brilliance) .....	27
Transposing the Pitch in Semitones .....	28
Fine-tuning the Pitch .....	29
Setting the Scale Tuning .....	30

<b>Playing Back Songs</b> .....	<b>31</b>
Songs compatible with this instrument .....	31
Playing back Songs .....	32
<b>Recording Your Performance</b> .....	<b>34</b>
<b>Using USB Flash Drives</b> .....	<b>36</b>
About USB Flash Drives .....	36
Formatting USB Flash Drive .....	37
Copying User Songs in the Instrument to USB Flash Drive .....	38
Deleting a Song file .....	39
Managing files on a USB flash drive .....	39
<b>Backup Data and Initializing</b> .....	<b>40</b>
Backup Data in Internal Memory .....	40
Initializing the Backup Data .....	40
<b>Connections</b> .....	<b>41</b>
Connecting Audio Devices ([AUX IN] jack, AUX OUT [L/L+R] [R] jacks) .....	41
Connecting to a Mixer—OUTPUT [L] [R] jacks (Balanced) .....	42
Connecting to a Computer ([USB TO HOST] terminal) .....	43
Connecting to an iPhone/iPad (MIDI [IN] [OUT] connectors, [USB TO HOST] terminal) .....	43
Connecting External MIDI Devices (MIDI [IN] [OUT] connectors) .....	44

## Appendix

This section includes a list of display messages, Quick Operation Guide and other information.

<b>Message List</b> .....	<b>46</b>
<b>Troubleshooting</b> .....	<b>47</b>
<b>Preset Song List</b> .....	<b>48</b>
<b>Assembling the Unit</b> .....	<b>49</b>
<b>Specifications</b> .....	<b>52</b>
<b>Index</b> .....	<b>53</b>
<b>Quick Operation Guide*</b> .....	<b>54</b>

\* This is a quick reference for operation of the functions assigned to the buttons and keyboard.

## About Manuals

This instrument has the following documents and instructional materials.

### ■ Included Documents



#### Owner's Manual (this book)

This manual describes how to use this instrument.

### ■ Online Materials (from Yamaha Downloads)



#### iPhone/iPad Connection Manual (only in English, French, German and Spanish)

Explains how to connect the instrument to smart devices, such as an iPhone, iPad, etc.



#### Computer-related Operations

Includes instructions on connecting this instrument to a computer, and operations related to transferring files and MIDI data.



#### MIDI Reference

Contains MIDI related information such as MIDI Data Format and the MIDI Implementation Chart.



#### MIDI Basics (only in English, French, German and Spanish)

Contains basic explanations about MIDI.

To obtain these manuals, access the Yamaha Downloads, enter the model name for searching the desired files.

**Yamaha Downloads** <https://download.yamaha.com/>

## Included Accessories

- Owner's Manual (this book)
- Online Member Product Registration  
The "PRODUCT ID" on the sheet will be needed when you fill out the User Registration form.
- Warranty\*

- Felt key cover
- Power cord
- Bench\*

\* May not be included depending on your area. Check with your Yamaha dealer.

# Panel Controls and Terminals

## Overview

The jacks and terminals on the underside of the instrument as shown here may seem to be in reverse from your perspective in front of the instrument. Make sure when using these to carefully check the names as printed on the panel before making connections.

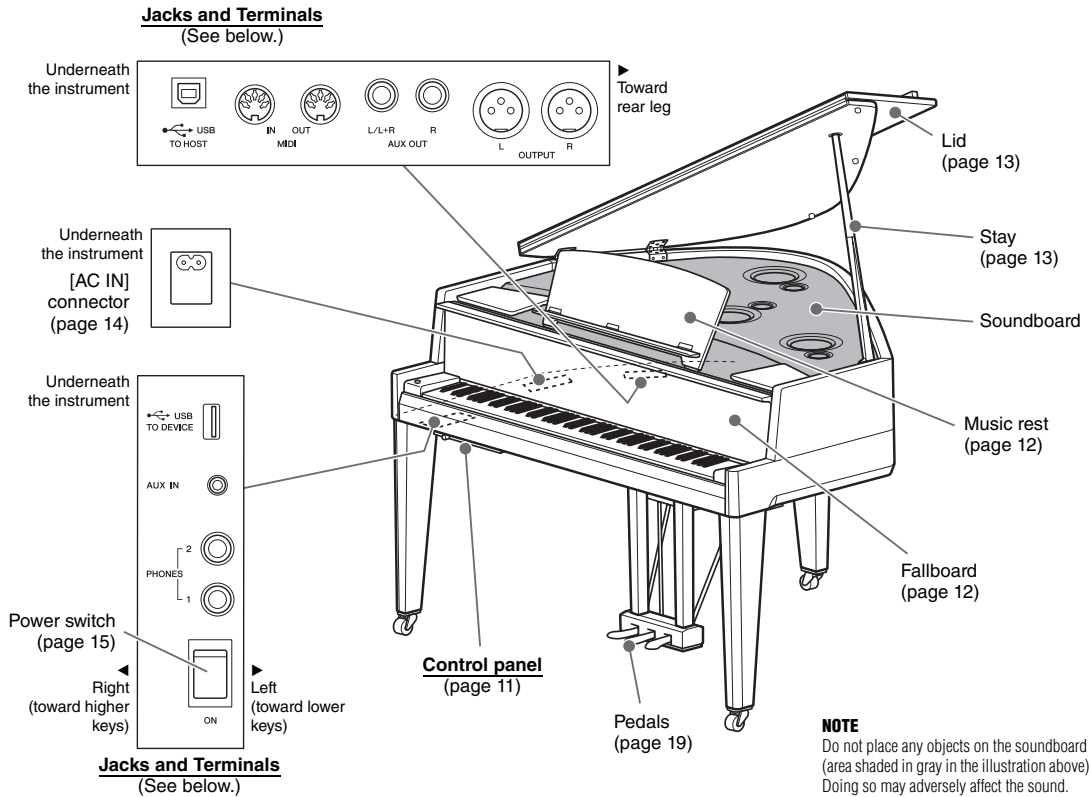

## Jacks and Terminals

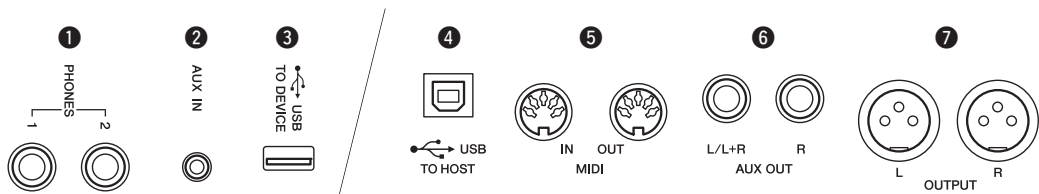

- |                                          |                                                 |
|------------------------------------------|-------------------------------------------------|
| 1 [PHONES] jacks ..... page 18           | 4 [USB TO HOST] terminal ..... page 43          |
| 2 [AUX IN] jack..... page 41             | 5 MIDI [IN] [OUT] connectors ..... pages 43, 44 |
| 3 [USB TO DEVICE] terminal ..... page 36 | 6 AUX OUT [L/L+R] [R] jacks ..... page 42       |
|                                          | 7 OUTPUT [L] [R] jacks ..... page 42            |

## Control Panel

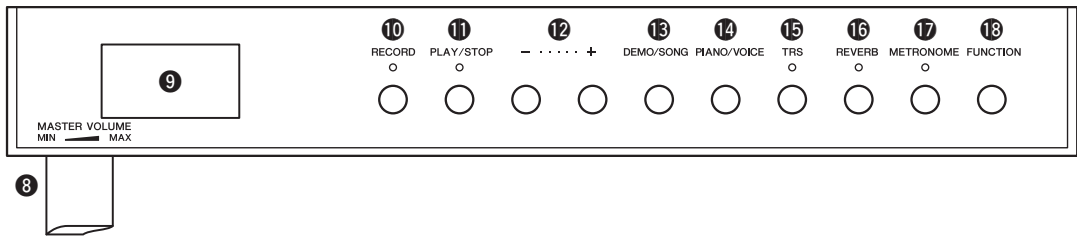

- 8 [MASTER VOLUME] control ..... page 17
- 9 Display ..... See below.
- 10 [RECORD] button ..... page 35
- 11 [PLAY/STOP] button ..... pages 32, 35
- 12 [+]/[-] button
- 13 [DEMO/SONG] button ..... pages 21, 32, 34
- 14 [PIANO/VOICE] button ..... page 20
- 15 [TRS] button ..... page 25
- 16 [REVERB] button ..... page 27
- 17 [METRONOME] button ..... pages 22, 23
- 18 [FUNCTION] button ..... pages 16, 27, 28, 29

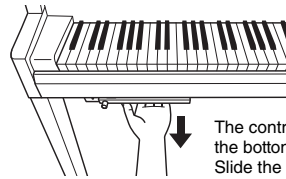

The control panel is located at the bottom left of the instrument. Slide the panel out to use it.

**NOTICE**  
Do not pull on the [MASTER VOLUME] control to slide out the control panel.

### Display

Indicates various values such as Song number and Parameter value. Note that the display turns dark and cannot be seen after the value is set.

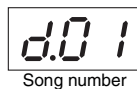

This display also indicates various three-character messages. For details, refer to page 46.

# Playing the Keyboard

## Opening/Closing the Fallboard

To open the fallboard, hold the hand grip with both hands, then lift the fallboard slightly, and push it up and back. To close the fallboard, lower the fallboard back in place gently with both hands.



**⚠ CAUTION**  
Be careful to avoid catching your fingers when opening/closing the fallboard.

The fallboard is equipped with the special SOFT-CLOSE™ mechanism which closes the cover slowly.

**⚠ CAUTION**

- Hold the fallboard with both hands when opening or closing it. Do not release it until it is fully opened or closed. Be careful to avoid catching fingers (yours or others, especially children's) between the fallboard and the unit.
- Do not apply excessive force when closing the fallboard. Applying excessive force to the fallboard when closing it could damage the SOFT-CLOSE™ mechanism, and possibly result in injury to your hands and fingers caught under the closing fallboard.
- Do not place anything (such as metal objects or pieces of paper) on top of the fallboard. Small objects placed on the fallboard may fall inside the unit when the fallboard is opened and may be nearly impossible to remove. Once inside, they could cause electric shock, short circuit, fire or other serious damage to the instrument.

## Using the Music Rest

**⚠ CAUTION**

When raising or lowering the music rest, do not release your hands from the music rest until it is all the way up or down.

### To raise the music rest:

- 1 Gently open the front portion of the lid.

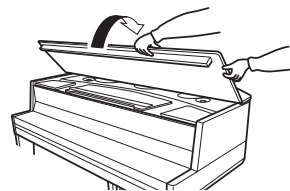

- 2 Pull the music rest up and toward yourself until it remains at the desired angle. The music rest is latched at angles of 35 degrees and 70 degrees.

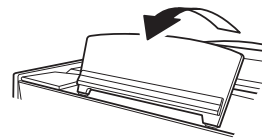

- 3 Open the music brace.

**⚠ CAUTION**

Do not apply excessive force to the music brace. Doing so could release the stopper of the music rest and the music rest could be lowered suddenly, possibly resulting in injury to your hands and fingers caught under the music rest.

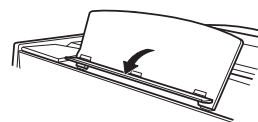

## To lower the music rest:

- 1 Close the music brace.
- 2 Pull the music rest toward yourself as far as it will go. When the music rest is at a 35 degree angle, raise it to a 70 degree angle, then pull it toward yourself.
- 3 Gently lower the music rest backward until it is all the way down.
- 4 Gently close the front portion of the lid.

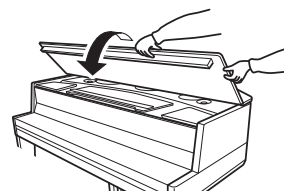
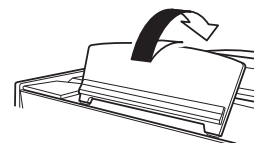
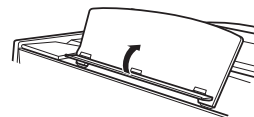

## Opening/Closing the Lid

### **⚠ WARNING**

Do not let children open or close the lid. Also, be careful to avoid catching fingers (yours or others, and especially those of children) when raising or lowering the lid.

### To open the lid

- 1 Gently open the front portion of the lid.

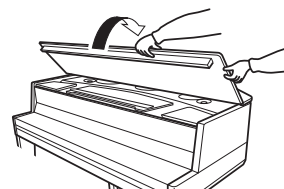

- 2 Hold the right side of the lid and raise it.
- 3 Raise the lid stay and carefully lower the lid so that the end of the stay fits into the recess in the lid.

### **⚠ WARNING**

- Make sure that the end of the stay fits securely in the lid recess. If the stay is not properly seated in the recess, the lid may fall, causing damage or injury.
- When the lid is open, do not place your head or other parts of your body under it. Otherwise, severe injury could result if the lid should fall.
- Be careful that you or others do not bump the stay while the lid is raised. Also, make sure to close the lid when moving the instrument. If bumped, the stay may be dislodged out of the lid recess causing the lid to fall.

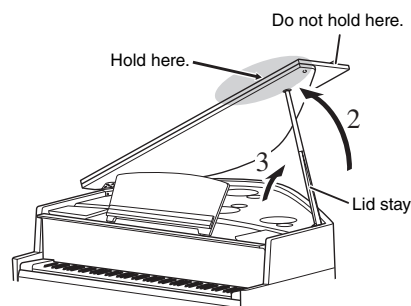

## To close the lid

- 1 **Hold the lid stay and carefully raise the lid.**
- 2 **Hold the lid in its raised position and lower the lid stay.**
- 3 **Carefully lower the lid.**  
When using the music rest, lower the music rest (page 13) before going on to the next step.
- 4 **Gently close the front portion of the lid.**

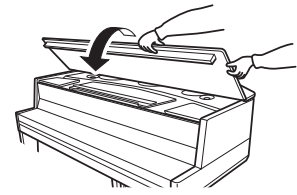
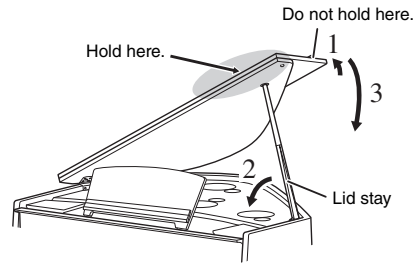

## Power Supply

- 1 **Make sure the power switch on the instrument is set to the off position.**

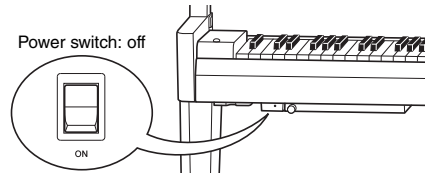

- 2 **Connecting the power cord**

- 2-1 Set the voltage selector and insert the power cord plug to the [AC IN] connector. Refer to the “Panel Controls and Terminals” on page 10 for information on the location of the [AC IN] connector.

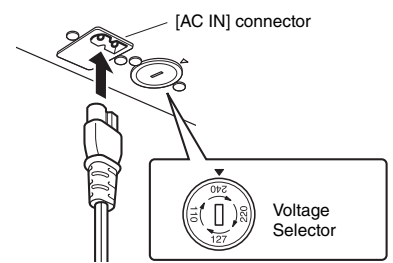

### Voltage Selector

Before connecting the AC power cord, check the setting of the voltage selector which is provided in some areas. To set the selector for 110V, 127V, 220V or 240V main voltages, use a “minus” screwdriver to rotate the selector dial so that the correct voltage for your region appears next to the pointer on the panel. The voltage selector is set at 240V when the unit is initially shipped. After the proper voltage has been selected, connect the AC power cord to the AC IN and an AC wall outlet. A plug adaptor may be also provided in some areas to match the pin configuration of the AC wall outlets in your area.

### ⚠ WARNING

**Make sure your instrument is rated for the AC voltage supplied in the area in which it is to be used. (The voltage rating appears on the name plate on the bottom panel). Connecting the unit to an inappropriate AC supply can seriously damage the internal circuitry and may even pose a shock hazard!**

- 2-2 Insert the plug on the other end of the power cord to a standard AC outlet.

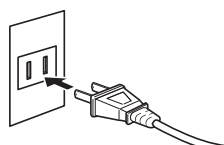

(The shape of the plug differs depending on the locale.)

**⚠ WARNING**

Use only the AC power cord supplied with the instrument. If the supplied power cord is lost or damaged and needs to be replaced, contact your Yamaha dealer. The use of an inappropriate replacement can pose a fire and shock hazard!

**⚠ WARNING**

The type of AC power cord provided with the instrument may be different depending on the country in which the instrument was purchased. (In some areas a plug adaptor may be provided to match the pin configuration of the AC wall outlets in your area.) Do NOT modify the plug provided with the instrument. If the plug will not fit the outlet, have a proper outlet installed by a qualified electrician.

**⚠ CAUTION**

When setting up the product, make sure that the AC outlet you are using is easily accessible. If some trouble or malfunction occurs, immediately turn off the power switch and disconnect the plug from the outlet.

**NOTE**

When disconnecting the power cord, first turn off the power, then follow this procedure in reverse order.

## Turning the Power On/Off

- 1 Grip the control panel located at the bottom left of the instrument and slide it out towards you.

**NOTICE**

Do not pull on the [MASTER VOLUME] control to slide out the control panel.

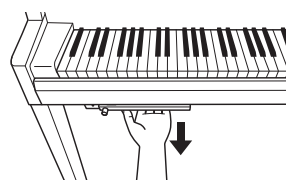

- 2 Turn down the [MASTER VOLUME] control to "MIN."

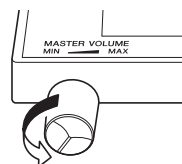

- 3 Turn on the switch located on the bottom left of the keyboard to turn the power on.

The [POWER] indicator located below the left end of the keyboard lights up. The display indicators flash in a pattern, indicating the instrument is currently starting up, and stop flashing when startup is completed.

**NOTICE**

Do not press any keys until the instrument has completely started up (approx. ten seconds after turning on the switch). Doing so may cause some keys to not sound normally.

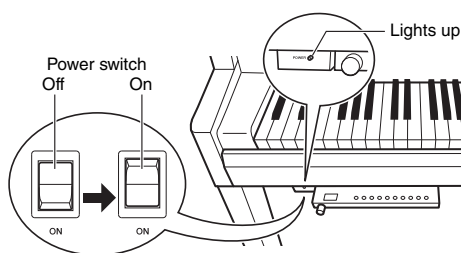

- 4 Playing the keyboard.

While playing the keyboard, adjust the volume level by using the [MASTER VOLUME] control located at the left of the panel.

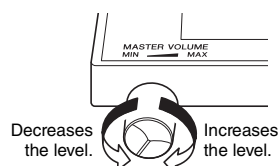
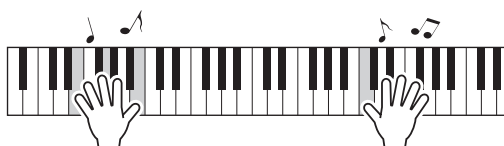

## 5 Turn the switch off to turn the power off.

The [POWER] indicator turns off. Slide the control panel back into the bottom of the keyboard after use.

### ⚠ CAUTION

Even after the power switch is turned off, electricity is still flowing to the instrument at the minimum level. Remove the electric plug from the outlet when the instrument is not to be used for extended periods of time, or during electrical storms.

### NOTICE

Press only the power switch when turning the power on. Any other operations, such as pressing the keys, buttons or pedals may cause the instrument to malfunction.

## Auto Power Off function

To prevent unnecessary power consumption, this instrument features an Auto Power Off function that automatically turns the power off if the instrument is not operated for approximately 15 minutes.

### Disabling Auto Power Off (simple method)

Turn the power on while holding down the lowest key on the keyboard.

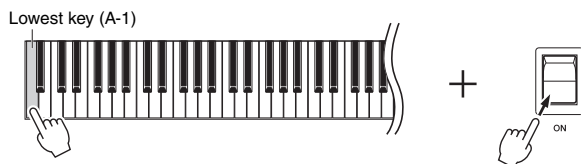

The indication “P<sub>o</sub>F” appears on the display briefly and Auto Power Off is disabled.

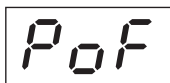

### Disabling or enabling the Auto Power Off setting

While the power is on, simultaneously hold down the [FUNCTION] button and press the A5 key. Pressing the A5 key repeatedly in this condition toggles between “OFF” (disabled) and “ON” (enabled), and the setting appears on the display.

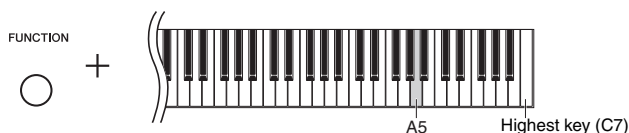

### NOTE

To turn the power on again after Auto Power Off has been enabled, turn the power switch to the off position once, and then back to the ON position.



## Adjusting the Master Volume

To adjust the volume level by using the [MASTER VOLUME] control located at the left of the panel while playing the keyboard.

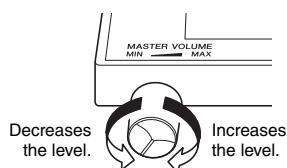

### **⚠ CAUTION**

Do not use this instrument at a high volume level for a long period of time, or your hearing may be damaged.

## Intelligent Acoustic Control (IAC)

This function automatically adjusts and controls the sound quality according to the overall volume of the instrument. Even when the volume is low, it permits both low sounds and high sounds to be clearly heard. Note that the IAC is effective only from the sound output of the instrument speakers.

### ● To turn on/off the IAC:

While holding down [FUNCTION], press the C0 key repeatedly (as necessary).

Default setting: On

### ● To adjust the IAC Depth:

While holding down [FUNCTION], press one of the keys between A0–D#1.

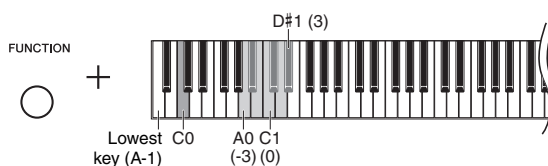

Setting range: -3 (A0) – 0 (C1) – 3 (D#1)

Default setting: 0 (C1)

The higher the value, the more clearly that low and high sounds are heard at lower volume levels.

## Using Headphones

Since this instrument is equipped with two [PHONES] jacks, you can connect two sets of standard stereo headphones. If you are using only one set of headphones, insert a plug into either jack; this automatically shuts off the speakers.

### CAUTION

Avoid listening to the instrument at a high volume level through headphones for a long period of time, to prevent hearing damage.

### NOTE

The TRS is turned off when headphones are connected. Press the [TRS] button to turn it on (page 25).

### NOTE

When the TRS (page 25) is on, sound can be heard to some degree even when the headphones are connected.

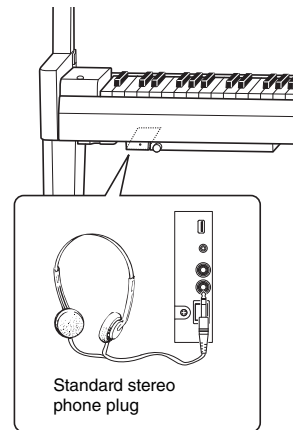

## Reproducing the Natural Sound Distance Sensation (when using Headphones)—Binaural Sampling and Stereophonic Optimizer

This instrument features two advanced technologies that allow you to enjoy exceptionally realistic, natural sound, even though listening on headphones.

### ● Binaural Sampling (“CFX Grand” Voice only)

Binaural sampling is a method that uses two special microphones set at the ear position of a performer and records the sound from a piano as it is. Listening to the sound with this effect through headphones gives the impression of being immersed in the sound, as if it was actually emanating from the piano. Moreover, you can enjoy the sound naturally for a long time without ear strain. When the default voice, “CFX Grand” (page 20) is selected, connecting the headphones automatically enables the binaural sampling sound.

### ● Stereophonic Optimizer (Voices other than “CFX Grand”)

The Stereophonic Optimizer is an effect which reproduces natural sound distance like the sound of binaural sampling even though you hear it on headphones. When the voice except “CFX Grand” (page 20) is selected, connecting the headphones makes this Stereophonic Optimizer effective.

### Turning the Binaural Sampling and Stereophonic Optimizer function on/off

When headphones are connected, the sound from this instrument changed to the sound of Binaural Sampling or the sound enhanced with the Stereophonic Optimizer. Since these sounds are optimized for listening with headphones, we recommend that you set this function to “OFF” (as described below).

#### You should turn these functions off when:

- Playing the sound of this instrument with an external powered speaker system or a mixer, while monitoring the sound output from this instrument on connected headphones.
- Making an audio recording (page 34) and then playing that recorded audio Song through speakers.  
(Make sure to turn off these functions before audio recording.)

#### NOTE

Before connecting an external powered speaker system or a mixer, be sure to read “Using an External Stereo System for Playback—AUX OUT [L/L+R] [R] jacks (unbalanced)” (page 42) or “Connecting to a Mixer—OUTPUT [L] [R] jacks (Balanced)” (page 42).

While holding down [PIANO/VOICE] button, press the C6 key repeatedly (if necessary) to turn this function on/off. The specified value is shown on the display while both controls are held.

Default setting: On

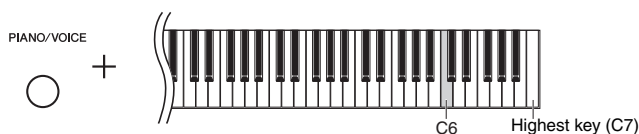

## Using the Pedals

The instrument has three pedals that produce a range of expressive effects similar to those produced by the pedals on an acoustic piano.

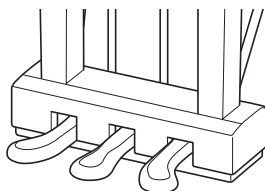

### Damper Pedal (Right)

Pressing this pedal will sustain notes longer. Releasing this pedal immediately stops (damps) any sustained notes. The damper pedal features a half-pedal function.

#### ● Half-pedal function

This function allows the sustain length to vary depending on how far the pedal is pressed. The farther you press the pedal, the more the sound sustains. For example, if you press the damper pedal and all notes you are playing sound a bit murky and loud with too much sustain, you can release the pedal half way to subdue the sustain (murkiness).

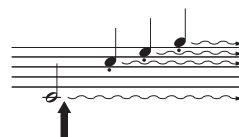

If you press and hold the damper pedal here, all the notes shown will be sustained.

### Sostenuto Pedal (Center)

Pressing this pedal while holding the notes will sustain the pressed notes (as if the damper pedal had been pressed), but all subsequently played notes will not be sustained. This makes it possible to sustain a chord, for example, while the other notes are played “staccato.”

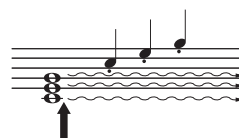

If you press and hold the sostenuto pedal here, only the notes held at this timing will be sustained.

### Soft Pedal (Left)

Pressing this pedal will reduce the volume and slightly change the timbre of the notes. The notes played before this pedal is pressed are not affected.

# Basic Operations and More

## Selecting a Voice

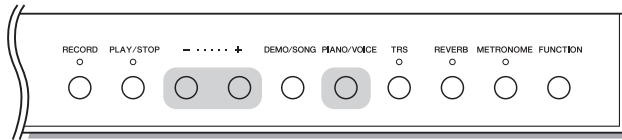

### ● To select the CFX Grand Voice:

Simply press [PIANO/VOICE].

### ● To select a different Voice:

While holding down [PIANO/VOICE], press [+] or [-].

### NOTE

To understand the characteristics of various voices, listen to demo songs for each voice (page 21).

## Voice List

Display	Voice name	Descriptions	VRM*
	CFX Grand	Four-channel Voice featuring multi sampling of Yamaha's CFX flagship concert grand piano sound, with wide dynamic range for maximum expressive control. It is suitable for playing in any music genre and style. When headphones are connected, this Voice is automatically changed to "Binaural CFX Grand" (below).	○
!	Binaural CFX Grand	Yamaha's CFX flagship concert grand piano sound sampled by Binaural Sampling, the method optimized for headphone use. Listening this through headphones gives the impression of being immersed in the sound, as if it was actually emanating from the piano. This Voice is selected automatically when headphones are connected. Refer to page 18 for details. (This Voice cannot be selected following the procedure of "Selecting a Voice" instructions above.)	○
2	Bösendorfer Imperial	The sound of the famed Vienna-made Bösendorfer flagship grand piano, utilizing four-channel sampling. This Voice has a rich and captivating sound, ideal for expressing the most delicate and tender musical passages.	○
3	Bright Grand	Bright piano sound. Good for clear expression and "cutting through" other instruments in an ensemble.	○
4	Bösendorfer Grand	The Bösendorfer grand piano sound with a lively attack and brilliant presence.	○
5	Pop Grand	A bright, richly metallic sound ideal for pop music styles and for playing in ensembles.	○
6	Stage E.Piano	The sound of an electric piano using hammerstruck metallic "tines." Soft tone when played lightly, and an aggressive tone when played hard.	-
7	DX E.Piano	An electronic piano sound produced by an FM synthesizer. The tone will change as you vary your playing touch. Ideal for popular music.	-
8	Vintage E.Piano	A different type of electric piano sound than Stage E.piano. Widely used in rock and popular music.	-
9	Harpsichord 8'	The sound of the instrument frequently used in baroque music. Variations in playing touch will not affect the volume, and a characteristic sound will be heard when you release the key.	-
!9	Harpsichord 8'+4'	A harpsichord with an added upper octave. Produces a more brilliant sound. Variations in playing touch will not affect the volume.	-

\*VRM: Simulated string resonance sound with physical modeling when the damper pedal is pressed or keys are pressed. Refer to page 26 for details.

## Listening to the Voice Demo Songs

Demo Songs effectively demonstrate each of this instrument's Voices.

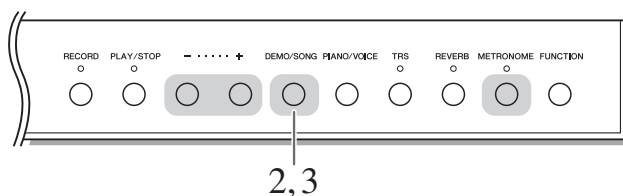

**1 Select the Voice for the Demo Song that you want to listen to.**

**2 Press [DEMO/SONG].**

The Demo Song for the Voice selected in Step 1 starts.

**To change the Demo Song during playback:**

Press [+] or [-].

**To adjust the playback tempo:**

While holding down [METRONOME], press [+] or [-].

**3 Press [DEMO/SONG] again to stop playback.**

**NOTE**

You can play the keyboard along with the demo song.

**NOTE**

No MIDI data will be output during Voice Demo playback.

### Demo Song List

Display	Voice Name	Song Name	Composer
d01	CFX Grand Binaural CFX Grand	Prelude, Suite bergamasque	C.A.Debussy
d02	Bösendorfer Imperial	Consolation No.3	F.Liszt
d03	Bright Grand	Italienisches Konzert, BWV.971-1 1st mov.	J.S.Bach
d04	Bösendorfer Grand	-	-
d05	Pop Grand	-	-
d06	Stage E.Piano	-	-
d07	DX E.Piano	-	-
d08	Vintage E.Piano	-	-
d09	Harpsichord 8'	Concerto a cembalo obbligato, 2 violini, viola e continuo No.7, BWV.1058	J.S.Bach
d10	Harpsichord 8'+4'	Gigue, Französische Suiten No.5, BWV.816	J.S.Bach

The Songs d04, d05, d06, d07 and d08 are Yamaha's original pieces (©2016 Yamaha Corporation).

# Using the Metronome

The metronome feature is convenient for practicing with an accurate tempo.

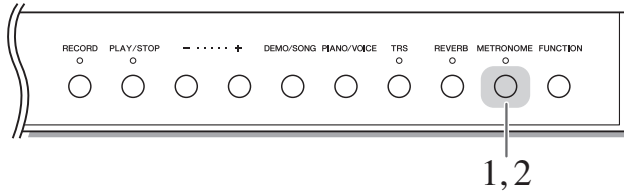

## 1 Press [METRONOME] to start the metronome.

While the metronome sounds, a dot at the right side of the LED display and the lamp of the metronome button flash on and off to the tempo.

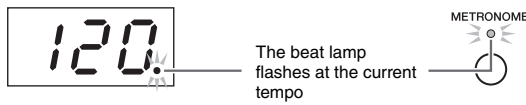

## 2 Press [METRONOME] again to stop the metronome.

### Selecting the Beat

While holding down [METRONOME], press one of the C3–F3 keys. The selected value is shown on the display while both controls are held.

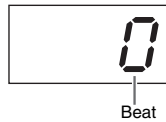
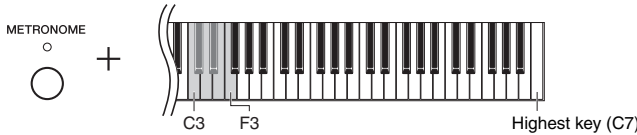

Default setting: 0 (No 1st beat accent)

**NOTE**

The Beat of the metronome is restored to the default setting when the power is turned off.

Display	Key	Beat	Display	Key	Beat
0	C3	0 (no 1st beat accent)	4	D#3	4
2	C#3	2	5	E3	5
3	D3	3	6	F3	6

Only the first beat is accented with a bell sound when set to a value other than 0.

### Adjusting the Metronome volume

While holding down [METRONOME], press one of the C1–G2 keys to set the volume. The specified value is shown on the display while both controls are held.

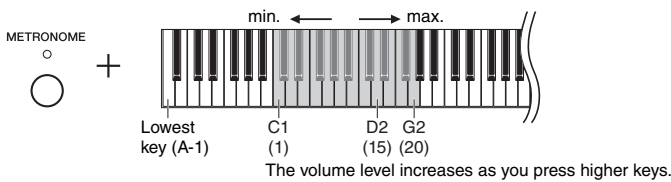

Setting range: 1–20  
Default setting: 15

**NOTE**

The metronome volume setting is retained even when the power is turned off.

## Adjusting the Tempo

The playback tempo of Metronome can be adjusted. You can also adjust the playback tempo of MIDI Song (page 31) as well as the playback speed of an Audio Song (page 31) as they are playing.

- **To increase or decrease the value by 1:**

While holding down [METRONOME], press [+] (or the C#5 key) to increase or [-] (or the B4 key) to decrease. While only the Metronome is playing, simply press [+] or [-] to change the tempo of the Metronome.

- **To increase or decrease the value by 10:**

While holding down [METRONOME], press the D5 key to increase or the A#4 key to decrease.

- **To reset the value to the default:**

While holding down [METRONOME], press the C5 key or press [+] and [-] simultaneously. While only the Metronome is playing, simply press both [+] and [-] simultaneously to reset the default tempo of the Metronome.

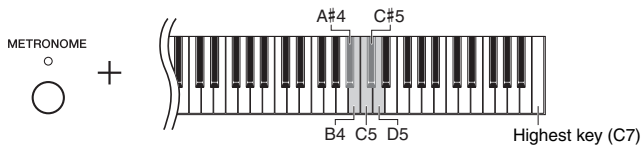

**NOTE**

Adjusting the playback tempo of Metronome cannot be done during the playback of Audio Songs (page 31).

**Metronome**

Setting range: 5 to 500 beats per minute  
Default setting: 120

**MIDI Song**

Setting range: 5 to 500 beats per minute  
Normal setting: Depends on the selected song

**Audio Song**

Setting range: 75% to 125%  
Normal setting: 100%

**NOTE**

The metronome tempo is restored to the default setting when the power is turned off.

## Changing the Touch Sensitivity

You can specify the Touch Sensitivity (how the sound responds to the way you play the keys).

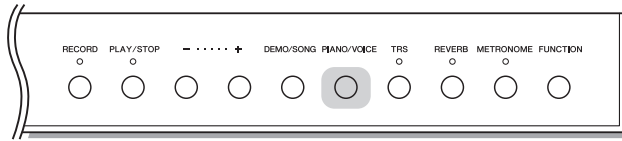

While holding down [PIANO/VOICE], press one of the A6–C7 keys. The selected Touch Sensitivity is shown on the display while both controls are held.

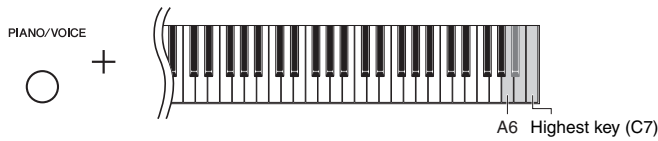

Display	Key	Touch Sensitivity	Descriptions
<i>FFF</i>	A6	Fixed	The volume level does not change at all regardless of whether you play the keyboard soft or hard.
<i>1</i>	A#6	Soft	The volume level does not change much when you play the keyboard soft or hard.
<i>2</i>	B6	Medium	This is the standard piano touch response.
<i>3</i>	C7	Hard	The volume level changes very widely from pianissimo to fortissimo to facilitate dynamic and dramatic expression. You have to hit the keys hard to produce a loud sound.

Default setting: 2 (Medium)

**NOTE**  
The touch type is restored to the default setting when the power is turned off.

**NOTE**  
This setting does not change the weight of the keyboard, but only the response.



## Adjusting the Strength of Vibration (TRS)

This instrument features a special TRS (Tactile Response System) that enables you to feel the natural vibration or resonance of the instrument when you play the keyboard, just as on an actual acoustic piano. You can select the strength of vibration for your taste.

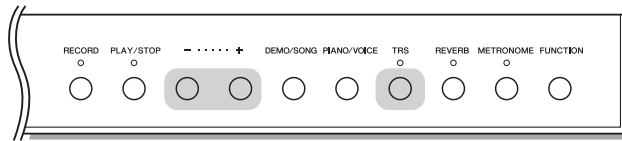

### Turning the TRS function on or off

Press the [TRS] button to switch the TRS function on or off.

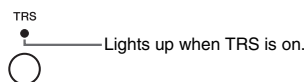

### Adjusting the strength of vibration

While holding down the [TRS] button, press the [+] or [-] button to adjust the strength of vibration. The current strength setting appears on the display while both controls are held.

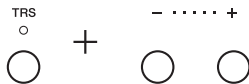

Strength of vibration

Setting range: 1 (weak) – 3 (strong)  
Normal setting: 2

#### NOTE

The actual vibration strength you feel differs depending on the selected voice, even when the TRS value on the display is the same.

#### NOTE

To display the TRS value, press just the [TRS] button.

#### NOTE

The TRS function is turned off when headphones are connected. Press the [TRS] button to turn it on.

When headphones are connected, the vibration is weakened even if the setting value has not been changed.

## Playing the Realistic Resonance-enhanced VRM Voices

On an actual acoustic piano, if you press the damper pedal and play a key, not only does the string of the pressed key vibrate, it also causes other strings and the soundboard to vibrate, with each influencing the rest, creating a rich and brilliant resonance that sustains and spreads. The VRM (Virtual Resonance Modeling) technology featured in the N3X reproduces the complicated interaction of both string and soundboard resonance faithfully using a virtual musical instrument (physical modeling), and makes the sound more like a real acoustic piano. Since instantaneous resonance is made at the moment according to the state of the keyboard or pedal, you can vary the sound expressively by changing the timing of your pressing the keys, and the timing and depth of your pressing the pedal.

The default setting of this function is on. Simply by selecting a VRM Voice (page 20), you can enjoy the VRM effect. You can turn the VRM function on or off, and adjust the depth.

### Turning the VRM function on or off

While holding down [PIANO/VOICE], press the C0 key repeatedly (if necessary).

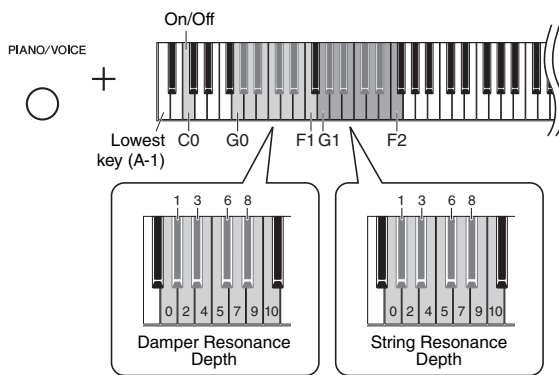

### Adjusting the depth of the VRM effect

While holding down [PIANO/VOICE], press one of the keys in the ranges of G0-F1 and G1-F2. During the operation, the specified value is shown on the display.

Display	Key	Value	Descriptions
G- iG	G0-F1	Damper Resonance Depth	Adjusts the depth of the VRM effect heard when pressing the damper pedal.
G- iG	G1-F2	String Resonance Depth	Adjusts the depth of the VRM effect heard when playing the keyboard.

Setting range: 0-10  
Default setting: 5

Setting range: 0-10  
Default setting: 5

## Enhancing the Sound with Reverb

The Reverb effect simulates the natural reverberation of a concert hall.

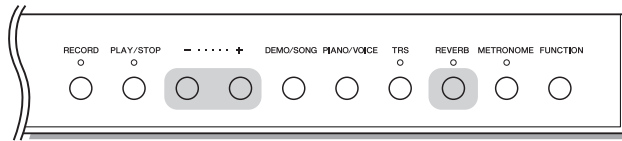

### Turning the Reverb on or off

Press [REVERB] repeatedly (as necessary).

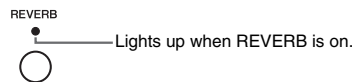

### Adjusting the Reverb Depth

While holding down [REVERB], press [+] or [-]. The current value is shown on the display while both controls are held.

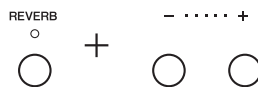

To restore the default value, press [+] and [-] simultaneously while holding [REVERB].

Setting range: 1–20  
Default setting: 5

**NOTE**  
The Reverb Depth is restored to the default setting when the power is turned off.

**NOTE**  
Holding [REVERB] shows the Reverb Depth value on the display.

## Adjusting the Brightness of the Sound (Brilliance)

To adjust the brightness of the sound, simultaneously hold down [FUNCTION] and press one of the A#1–D2 keys. During the operation, the specified value is shown on the display.

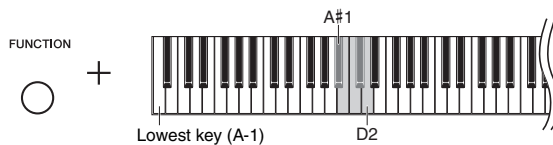

Display	Key	Brilliance	Descriptions
1	A#1	Mellow 2	Soft and mellow tone. The sound becomes more mellow and rounder.
2	B1	Mellow 1	A mellow tone between Normal and Mellow 2.
3	C2	Normal	Standard tone.
4	C#2	Bright 1	A bright tone between Normal and Bright 1.
5	D2	Bright 2	Bright tone. The sound becomes brighter.

Default setting: 3 (Normal)

## Transposing the Pitch in Semitones

You can shift the pitch of the entire keyboard up or down in semitones to facilitate playing in difficult key signatures and match the pitch of the keyboard to the range of a singer or other instruments. For example, if “+5” is selected, playing the key C produces a pitch of F, letting you play a song of F major as though it were in C major. The transposition setting affects not only the pitch of the keyboard but also the pitch of the MIDI Song (page 31) and Audio Song (page 31).

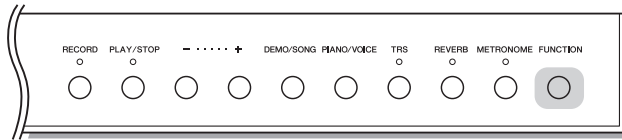

● **To transpose the pitch down:**

While holding down [FUNCTION], press a key between F#2 (-6) and B2 (-1).

● **To transpose the pitch up:**

While holding down [FUNCTION], press a key between C#3 (+1) and F#3 (+6).

● **To restore the original pitch:**

While holding down [FUNCTION], press the C3 key.

Default setting: 0 (Normal pitch)  
Setting range: -6 – +6

**NOTE**

The Transpose value is restored to the default setting when the power is turned off.

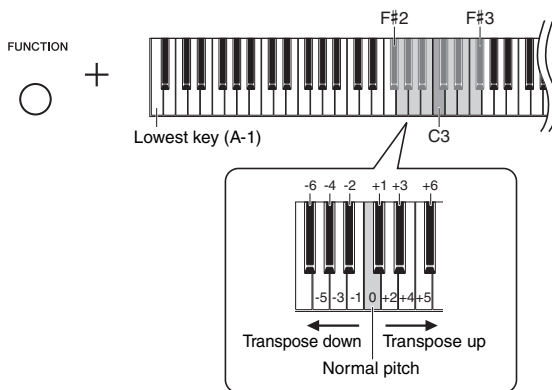

The specified value is shown on the display.

## Fine-tuning the Pitch

You can fine-tune the pitch of the entire instrument. This function is useful when you play this instrument along with other instruments or recorded music.

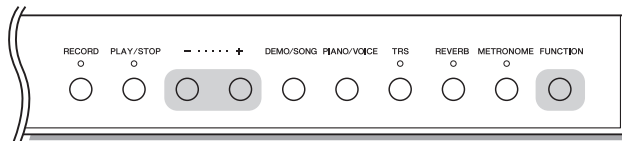

During the operation described below, you can check the Pitch value shown on the display. (The hundreds place value has been omitted.)

42.0

Example: 442.0Hz

- **To tune up (in roughly 0.2Hz steps):**

While holding down [FUNCTION], press [+]. Holding down both buttons shows the current pitch setting (Hz).

- **To tune down (in roughly 0.2Hz steps):**

While holding down [FUNCTION], press [-]. Holding down both buttons shows the current pitch setting (Hz).

- **To restore standard pitch:**

While holding down [FUNCTION], press [+] and [-] simultaneously. Holding down all three buttons shows the current pitch setting (Hz).

**NOTE**

The tuning value is retained even when the power is turned off.

**Hz (Hertz):**

This unit of measurement refers to the frequency of a sound and represents the number of times a sound wave vibrates in a second.

Setting range: 414.8–466.8Hz (=A3)  
Default setting: 440.0Hz (=A3)

## Setting the Scale Tuning

You can select various scales for the instrument. Equal Temperament is the most common contemporary piano tuning scale. However, history has known numerous other scales, many of which serve as the basis for certain genres of music. This feature lets you experience the tunings of these genres.

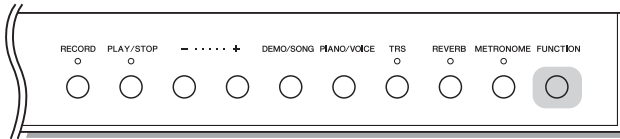

### Selecting a Scale

While holding down [FUNCTION], press one of the C5–F#5 keys. Holding down both controls shows the current value on the display.

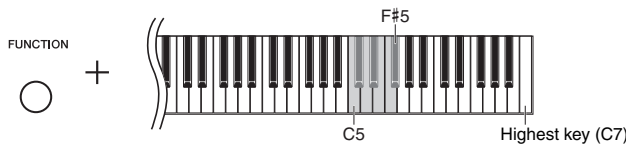

Default setting: 1 (Equal)

**NOTE**

The scale is restored to the default setting when the power is turned off.

Display	Key	Scale	Description
1	C5	Equal	The pitch range of each octave is divided equally into twelve parts, with each half-step evenly spaced in pitch. This is the most commonly used tuning in music today.
2	C#5	Pure Major	These tunings preserve the pure mathematical intervals of each scale, especially for triad chords (root, third, fifth). You can hear this best in actual vocal harmonies—such as choirs and a cappella singing.
3	D5	Pure Minor	
4	D#5	Pythagorean	This scale was devised by the famous Greek philosopher and is created from a series of perfect fifths, which are collapsed into a single octave. The 3rd in this tuning are slightly unstable, but the 4th and 5th are beautiful and suitable for some leads.
5	E5	Mean-Tone	This scale was created as an improvement on the Pythagorean scale, by making the major third interval more “in tune.” It was especially popular from the 16th century to the 18th century. Handel, among others, used this scale.
6	F5	Werckmeister	This composite scale combines the Werckmeister and Kirnberger systems, which were themselves improvements on the mean-tone and Pythagorean scales. The main feature of this scale is that each key has its own unique character. The scale was used extensively during the time of Bach and Beethoven, and even now it is often used when performing period music on the harpsichord.
7	F#5	Kirnberger	

### Selecting the Base Note

For scales 2 and 3 in particular, you should specify the key you intend to play (Base Note). While holding down [FUNCTION], press one of the C4–B4 keys. Holding down both controls shows the current value on the display.

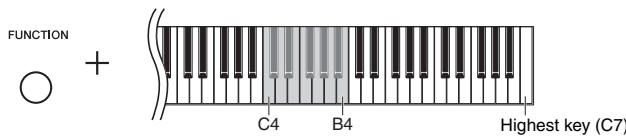

Default setting: C

**NOTE**

The base note is restored to the default setting when the power is turned off.

Key	Base Note	Key	Base Note	Key	Base Note	Key	Base Note
C4	C	D#4	E♭	F#4	F#	A4	A
C#4	C#	E4	E	G4	G	A#4	B♭
D4	D	F4	F	G#4	A♭	B4	B

Example:



F# (Followed by a high bar if sharp)

G

A♭ (Followed by a low bar if flat)

# Playing Back Songs

This instrument can play back Songs contained in internal memory or USB memory connected to the [USB TO DEVICE] terminal. There are two kinds of Songs that can be played back: MIDI Songs and Audio Songs.

## ● Song data formats that can be played

<b>Songs</b>	<b>MIDI Songs</b> A MIDI Song contains data of your keyboard performance (such as which keys you played and how hard you played them), and is not a recording of the actual sound itself. The performance information refers to which keys are played, at what timing, and at what strength—just as in a musical score. Based on the recorded performance information, the tone generator (of the digital piano, etc.) outputs the corresponding sound. A MIDI Song uses a small amount of data capacity in comparison to audio recording.	<b>Audio Songs</b> An Audio Song is a recording of the performed sound itself. This data is recorded in the same way as that used in recording cassette tapes, or with voice recorders, etc. This data can be played with a portable music player, etc., allowing you to easily let other people hear your performance.
<b>Data formats</b>	<b>SMF (Standard MIDI File) Formats 0 and 1</b> One of the most common and widely compatible MIDI formats used for storing sequence data. MIDI Songs recorded in this instrument are saved as SMF Format 0.	<b>WAV format (.wav)</b> Audio file format commonly used by computers. This instrument can play 44.1kHz/16bit stereo WAV files. Audio Songs recorded on this instrument are saved in this format.
<b>Extension</b>	.MID	.WAV

### NOTE

When playing back MIDI Songs containing Voices that are incompatible with this instrument such as XG and GM Songs, the Voices may not sound as intended on the original. In addition, Song data of MIDI channels 3–16 cannot be played back, since this instrument can recognize only MIDI channels 1 and 2. This is why you should only play back Songs which have data of only MIDI channels 1–2, to which the piano performance is assigned.

## Songs compatible with this instrument

### Song Category List ([xx] indicates numerals.)

Song Category		Song Number	Descriptions
<i>d</i> [xx]	Voice Demo Song (MIDI Song)	<i>d</i> 00 1– <i>d</i> 10	Each Song effectively demonstrates each of this instrument's Voices (page 21).
<i>P</i> [xx]	Preset Song (MIDI Song)	<i>P</i> 00 1– <i>P</i> 10	10 Piano Preset Songs in the instrument. Refer to the Preset Song List on page 48.
<i>R</i> [xx]*	Audio Song in USB flash drive	<i>R</i> 00– <i>R</i> 99	User Songs which have been recorded with this instrument (page 34)
		<i>C</i> 00– <i>C</i> 99**	External Songs, commercially available or which have been recorded on a computer, etc.
<i>S</i> [xx]*	MIDI Song in USB flash drive	<i>S</i> 00– <i>S</i> 99	User Songs which have been recorded with this instrument (page 34)
		<i>F</i> 00– <i>F</i> 99**	External Songs, commercially available or which have been recorded on a computer, etc.
<i>U</i> [xx]	MIDI Song in this instrument	<i>U</i> 00 1– <i>U</i> 10	User Songs which have been recorded to the instrument (page 34)
		<i>L</i> 00– <i>L</i> 99**	External Songs (commercially available or which have been recorded on a computer, etc.) transferred from a computer to this instrument.

\* Shown only when USB flash drive is connected.

\*\* When data does not exist, the song number is not displayed.

## ● User Songs and External Songs

Songs recorded by this instrument are called “User Songs” while Songs created in other ways or on other instruments are called “External Songs.” In USB flash drive, Songs in the USER FILES folder are handled as User Songs while Songs in a location other than the USER FILES folder are handled as External Songs. When you record a Song to USB flash drive, a USER FILES folder is created automatically and the resulting User Song will be saved in this folder.

## Playing back Songs

### To play back a Song on a USB flash drive:

Read "About USB Flash Drives" (page 36), then connect the USB flash drive to the [USB TO DEVICE] terminal, and follow the instructions below.

### 1 While holding down [DEMO/SONG], press [+] or [-] until the desired Song Category (page 31) appears on the display.

The Song Categories will appear on the display in the following order:

P.<sub>xx</sub> → (R.<sub>xx</sub>) → (S.<sub>xx</sub>) → U.<sub>xx</sub> → d.<sub>xx</sub> → P.<sub>xx</sub> → etc. If you wish to play back a "C.<sub>xx</sub>," "F.<sub>xx</sub>," or "L.<sub>xx</sub>" song, select the Song Category "R.<sub>xx</sub>," "S.<sub>xx</sub>," or "U.<sub>xx</sub>."

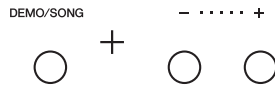

### 2 Press [+] or [-] to select the desired Song number, or "\*r d" (random) or "\*RL" (all).

To select "C.<sub>xx</sub>," "F.<sub>xx</sub>," or "L.<sub>xx</sub>," continue holding down [+] until they appear, or press [-] repeatedly. "C.<sub>xx</sub>" will appear after "R.<sub>99</sub>," "F.<sub>xx</sub>" will appear after "S.<sub>99</sub>," and "L.<sub>xx</sub>" will appear after "U.<sub>10</sub>" on the display. (When data does not exist, the song number is not displayed.)

●When a specific Song number (such as P.0 1 and U.0 1) is selected: Only the selected Song will be played back.

●When "\*r d" or "\*RL" is selected:

\*r d ..... Plays back the Songs of this type continuously in random order.

\*RL ..... Plays back all the Songs of this type continuously in sequential order.

The asterisk (\*) indicates "P," "R," "S," or "U" designations in the display.

For details, refer to page 31.

### 3 Press [PLAY/STOP] to start playback.

During playback, the current measure number (for MIDI Songs) or playing time (for Audio Songs) is shown on the display.

MIDI Song



Current measure number

Audio Song



Playing time

Indicates minutes. In case of 10 minutes or more, only the lowest digit is shown.      Indicates seconds.

### Adjusting the tempo (MIDI Songs) or playback speed (Audio Songs)

You change the playback tempo of MIDI Song. You can also adjust the playback speed of an Audio Song during its playback.

While holding down [METRONOME], press [+] or [-] to increase or decrease the value. To reset the value to default, press [+] and [-] simultaneously while holding down [METRONOME]. For details, refer to page 23.

#### NOTE

"R.<sub>xx</sub>" and "S.<sub>xx</sub>" are shown only when USB flash drive is connected.

#### NOTE

Song indications such as "F.<sub>99</sub>" and "C.<sub>99</sub>" may not appear immediately depending on the amount of the folders in the USB flash drive.

#### NOTE

The metronome can be used during playback. It will automatically stop when playback is stopped.

#### NOTE

You can play the keyboard along with Song playback.

#### NOTE

The Voice of the MIDI song can be changed during playback. The Voice of the MIDI song played is automatically assigned to the Voice played from the keyboard.

#### MIDI Song

Setting range: 5 to 500 beats per minute  
Normal setting: Depends on the selected song

#### Audio Song

Setting range: 75% to 125%  
Normal setting: 100%



### Adjusting the volume (only for Audio Songs)

The volume level of this instrument may be markedly different from that of a commercially available Audio Song or one recorded on another device. To adjust the volume of the Audio Song, hold down [DEMO/SONG] and press one of the C1–G2 keys.

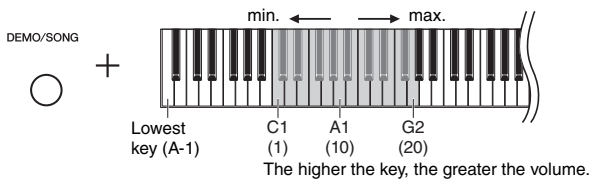

### Rewind/Fast forward

During playback, press [-] or [+] to move back or forth through the measures. Pressing one of these buttons once moves one measure back/forward for MIDI Songs, or one second for Audio Songs.

### Returning to the Song Top

During playback, press [-] and [+] simultaneously to jump to the top of the Song.

## 4 Press [PLAY/STOP] again to stop playback.

If a specific Song number is selected in Step 2, playback stops automatically by reaching the end of the Song.

### Setting the Character Code

If the Song cannot be called up, you may need to select the appropriate Character Code from the following two settings.

#### ● International

For playing back Songs with names using western European characters (including umlaut or diacritic marks). To select this, turn on the power while holding down the A-1 and A#-1 keys.

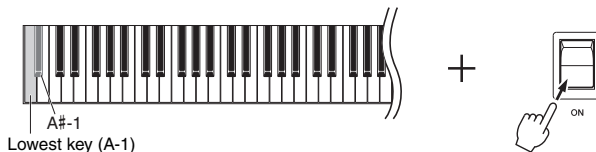

#### ● Japanese

For playing back Songs with names using Japanese characters. To select this, turn on the power while holding down the A-1 and B-1 keys.

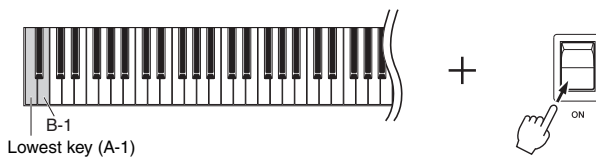

Setting range: 1–20  
Default setting: 16

#### NOTE

The playback of Audio Songs is output only from the right and left speakers, and not from the center and rear speakers.

#### NOTE

During playback of Demo Songs, Rewind/Fast Forward operations or returning to the Song top cannot be done.

Setting range: JA (Japanese) / Int (International)

Default setting: Int

# Recording Your Performance

This instrument allows you to record your performance by using one of the following two methods. The recorded performance can be played back as a User Song.

## ● MIDI recording

With this method, your keyboard performances are recorded and saved to the instrument or USB flash drive as a MIDI Song (via the SMF format 0). Up to 10 Songs can be recorded to the instrument, although more can be recorded to USB flash drive (see below).

## ● Audio recording

With this method, your keyboard performances are recorded then saved to USB flash drive as an Audio Song in stereo WAV format of normal CD-quality resolution. The saved Audio Song can be transmitted to then played on portable music players. The recordable time differs depending on the capacity of the USB flash drive.

## 1 Connect a USB flash drive to the [USB TO DEVICE] terminal.

### When is USB flash drive necessary?

MIDI Songs can be saved to internal memory of this instrument or to USB flash drive, while Audio Songs can only be saved to the USB flash drive.

As necessary, prepare a USB flash drive referring to “About USB Flash Drives” (page 36).

## 2 Select the Recording method.

### ●To make a MIDI Recording:

While holding down [DEMO/SONG], press [+] or [-] until “U\*\*” (for saving data to the instrument) or “S\*\*” (for saving data to the USB flash drive) is shown on the display.

### ●To make an Audio Recording:

While holding down [DEMO/SONG], press [+] or [-] until “R\*\*” (for saving data to the USB flash drive) is shown on the display.

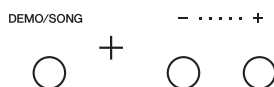

## 3 Press [+] or [-] to select a Song number.

- *U0 1-U 10* ..... User Song in this instrument (MIDI Song)
- *S00-S99* ..... User Song in USB flash drive (MIDI Song)
- *R00-R99* ..... User Song in USB flash drive (Audio Song)

### ●When the selected Song contains already-recorded data:

You can confirm it by checking the display.

When Song contains data:



Three dots light up.

When Song does not contain data:



Only the left-most dot lights up.

### NOTICE

When the selected Song contains data, keep in mind that recording new data will erase the existing data.

### NOTE

If you intend to play back your recording only on the instrument itself, we recommend using MIDI recording. Songs recorded with the MIDI recording method are output from the four speakers of the instrument, just as they are when you play/record. However, Songs recorded by Audio recording are output only from the left and right speakers, and do not use the center or rear speakers.

### NOTE

If you make an audio recording while using headphones and then play that recorded audio Song through speakers, you should set “Binaural sampling/Stereophonic Optimizer” to “OFF.” Refer to page 18 for details.

### NOTE

Record mode cannot be called up in the following situations.

- During Song playback (page 31)
- During file management operations such as Copy (page 38), Delete (page 39) and Format (page 37)

### When skipping Steps 1 to 4 with an unrecordable Song selected:

Pressing [RECORD] selects the lowest numbered Song (of those containing no data) as the Recording target.

- If “C\*\*” is selected, pressing [RECORD] selects “R\*\*” (Audio Song in the USB flash drive).
- If “F\*\*”, “L\*\*”, “P\*\*”, or “A\*\*” is selected, pressing [RECORD] selects “U\*\*” (MIDI Song in internal memory). If there is no empty User Song, “U0 1” will be as the Recording target.

#### 4 Select a Voice (page 20) and other parameters such as Beat (page 22) for recording.

#### 5 Press [RECORD] to engage the Record mode.

The [RECORD] lamp lights up, and the [PLAY/STOP] lamp flashes according to the current tempo.

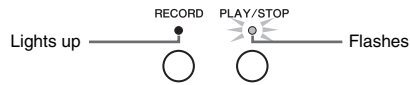

To exit from the Record mode, press [RECORD] again.

#### 6 Start recording.

Play a note on the keyboard or press [PLAY/STOP] to start recording.

##### ●With MIDI Recording:

While recording, the current measure number is shown on the display.

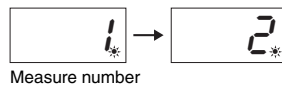

##### ●With Audio Recording:

While recording, the elapsed time is shown on the display.

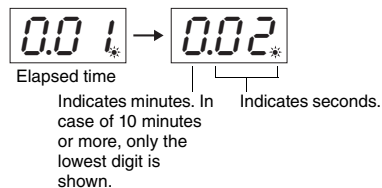

#### 7 Press [RECORD] or [PLAY/STOP] to stop recording.

Dashes appear on the display in succession, indicating that the recorded data is being saved. After the data is saved, an “END” message appears for three seconds, indicating that the Record mode is disengaged.

##### **NOTICE**

While dashes appear in the display in succession, never turn off the power or disconnect the USB flash drive. Doing so may delete all Song data in the instrument, including external Songs (page 31).

#### 8 Press [PLAY/STOP] to hear the recorded Song.

To stop playback, press [PLAY/STOP] again.

##### **Deleting a Song file**

If you want to delete the recorded Song, refer to page 39.

##### **Using the Metronome**

You can use the metronome while recording, although the metronome sound will not be recorded.

##### **If memory space is running low:**

An “END” or “FULL” message will appear in the display after pressing [RECORD]. If “END” appears, you can start recording, but the memory may become full during recording. If “FULL” appears, you cannot start recording. We recommend that you first remove any unnecessary files (page 39) to ensure sufficient memory capacity.

##### **NOTE**

If the memory becomes full, or the recording data or time exceed the maximum limit for one song during recording, “FULL” appears on the display and recording will stop automatically. In this situation, press any button to clear the “FULL” indication. Keep in mind that your performance data may not have been correctly saved.

##### **NOTE**

With audio recording, the sound input from the [AUX IN] jack is also recorded.

##### **NOTE**

The recorded User Song data on this instrument can be saved to a USB flash drive. Refer to page 38.

# Using USB Flash Drives

With a USB flash drive plugged in, you can use this instrument to perform the following tasks.

- **Formatting a USB flash drive** ..... page 37
- **Listening to songs stored on the USB flash drive** ..... page 31
- **Recording your performances on the USB flash drive** ..... page 34
- **Copying User Songs recorded on the instrument to the USB flash drive** ..... page 38
- **Deleting songs from the USB flash drive** ..... page 39

## NOTE

The Format, Copy and Delete operations cannot be done in the following situations.

- During Song playback (page 31)
- Record mode (page 35)

## About USB Flash Drives

### Precautions when using the [USB TO DEVICE] terminal

This instrument features a built-in [USB TO DEVICE] terminal. When connecting a USB device to the terminal, be sure to handle the USB device with care. Follow the important precautions below.

#### NOTE

For more information about the handling of USB devices, refer to the owner's manual of the USB device.

#### ■ Compatible USB devices

- USB flash drive

Other USB devices such as a USB hub, computer keyboard or mouse cannot be used.

The instrument does not necessarily support all commercially available USB devices. Yamaha cannot guarantee operation of USB devices that you purchase.

Before purchasing a USB device for use with this instrument, please visit the following web page:

<https://download.yamaha.com/>

Although USB devices 1.1 to 3.0 can be used on this instrument, the amount of time for saving to or loading from the USB device may differ depending on the type of data or the status of the instrument.

#### NOTE

The rating of the [USB TO DEVICE] terminal is a maximum of 5V/500mA. Do not connect USB devices having a rating above this, since this can cause damage to the instrument itself.

#### ■ Connecting a USB flash drive

When connecting a USB flash drive to the [USB TO DEVICE] terminal, make sure that the connector on the device is appropriate and that it is connected in the proper direction.

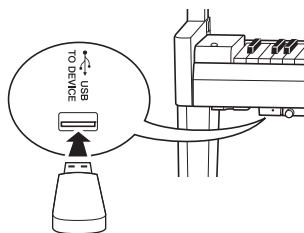

#### NOTICE

- **Avoid connecting or disconnecting the USB flash drive during playback/recording and file management operations (such as Save, Copy, Delete and Format), or when accessing the USB flash drive. Failure to observe this may result in "freezing" of the operation of the instrument or corruption of the USB flash drive and the data.**
- **When connecting then disconnecting the USB flash drive (and vice versa), make sure to wait a few seconds between the two operations.**

#### NOTE

Do not use an extension cable when you connect a USB flash drive.

#### ■ Using a USB flash drive

By connecting the instrument to a USB flash drive, you can save data you've created to the connected device, as well as read data from the connected USB flash drive.

#### ● Number of USB flash drives that can be used

Only one USB flash drive can be connected to the [USB TO DEVICE] terminal.

#### ● Formatting a USB flash drive

You should format the USB flash drive only with this instrument (page 37). A USB flash drive formatted on another device may not operate properly.

#### NOTICE

**The format operation overwrites any previously existing data. Make sure that the USB flash drive you are formatting does not contain important data.**

#### ● To protect your data (write-protect)

To prevent important data from being inadvertently erased, apply the write-protect provided with each USB flash drive. If you are saving data to the USB flash drive, make sure to disable write-protect.

#### ● Turning off the instrument

When turning off the instrument, make sure that the instrument is NOT accessing the USB flash drive by playback/recording or file management (such as during Save, Copy, Delete and Format operations). Failure to do so may corrupt the USB flash drive and the data.

## Formatting USB Flash Drive

### NOTICE

Executing the Format operation will delete all data in the USB flash drive. Before formatting, save important data to a computer or another storage device.

- 1 Connect the USB flash drive to the [USB TO DEVICE] terminal.
- 2 While holding [FUNCTION] and [PLAY/STOP], press [RECORD].  
“FOr” appears on the display for a while, then “n 5” appears. If you wish to cancel this operation, press [-] here.

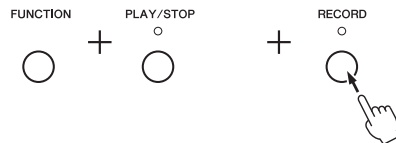

- 3 Press [+] to execute the Format operation.

Dashes appear in succession on the display, indicating that Formatting is in process. When the operation is completed, “ErD” appears on the display.

### NOTICE

While dashes appear in succession on the display, never turn off the power or disconnect the USB flash drive.

### NOTE

When you execute a Song Recording (page 35), Copy (page 38) or Delete (page 39) operation, a “UnF” prompt may appear in the display, indicating that the USB flash drive has not been formatted yet. In this case, execute the Format operation by proceeding from Step 2 as described at left.

## Copying User Songs in the Instrument to USB Flash Drive

You can copy the User Song in the instrument to the USB flash drive. The copied Song is saved as SMF format 0 to the “USER FILES” folder in the USB flash drive, and the file is automatically named as “USERSONG\*\*\*.MID” (\*\*: numerals).

- 1 **Connect the USB flash drive to the [USB TO DEVICE] terminal.**
- 2 **For the Copy source, select a User Song in this instrument.**  
For detailed instructions, refer to page 31.
- 3 **While holding [FUNCTION], press [PLAY/STOP].**

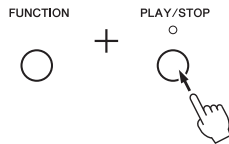

On the display, “SRU” appears for a while then the Song number (for example “5.00”) appears as Copy destination.

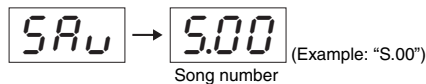

To cancel the Copy operation before it begins, press any button other than [PLAY/STOP] here.

- 4 **Press [PLAY/STOP] to execute the Copy operation.**  
Dashes appears in succession on the display, indicating that the Copy operation is in process. When the Copy is completed, “END” appears on the display.

**NOTICE**

When dashes appear in the display in succession, never turn off the power or disconnect the USB flash drive.

**NOTE**

If any Song other than one of the User Songs is selected in Step 2, “P r o” appears in Step 3. In this case, return back to Step 2.

**NOTE**

When there is insufficient free memory capacity in the USB flash drive, the copied Song cannot be saved. To ensure sufficient memory, try erasing unnecessary files (page 39).

## Deleting a Song file

A User Song can be deleted.

- 1 **If necessary, connect the USB flash drive to the [USB TO DEVICE] terminal.**
- 2 **Select the Song to be deleted.**  
For details on how to select a Song file, refer to page 32.
- 3 **While holding down [FUNCTION], press [RECORD].**

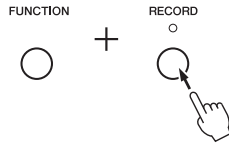

“DEL” appears on the display for a while, then “-” appears on the display. If you wish to cancel this operation, press [-].

- 4 **Press [+] to execute the Delete operation.**

Dashes appear in succession on the display, indicating that the Delete operation is in process. When the operation is completed, “END” appears on the display.

**NOTICE**

While dashes appear in succession on the display, never turn off the power or disconnect the USB flash drive.

**NOTE**

Song Playback is not available after executing Step 3. Make sure to confirm the to-be-deleted Song before executing Step 3.

**NOTE**

The operation here does not apply to Songs transferred from the computer to this instrument's internal memory. If you want to delete such a Song, use a computer.

## Managing files on a USB flash drive

When organizing files on a USB flash drive using a computer, etc., make sure to place External Songs only in the first, second, or third hierarchical folder level. This instrument will not be able to select or play songs from any level lower than that.

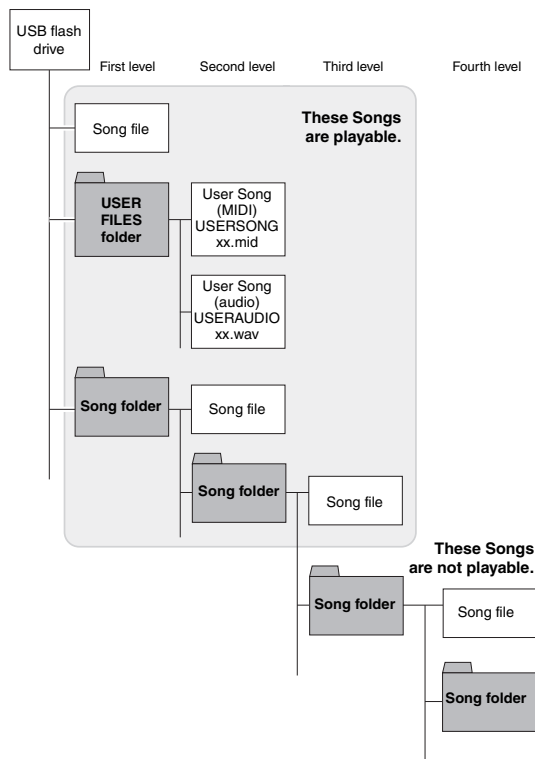

# Backup Data and Initializing

## Backup Data in Internal Memory

The following data, referred to as Backup data, as well as User Song data and External Song data will be maintained even if the power is turned off.

- Character Code ..... page 33
- Tuning ..... page 29
- IAC on/off ..... page 17
- IAC Depth ..... page 17
- Auto Power Off on/off ..... page 16
- Metronome volume ..... page 22
- Audio Song volume ..... page 33
- AUX IN Noise Gate on/off ..... page 41
- AUX OUT/OUTPUT Volume Fixed on/off ..... page 43

## Initializing the Backup Data

While holding down the C7 key, turn on the power. The Backup data (with the exception of “Character Code”) will be initialized. Note that User Songs and External Songs are not erased.

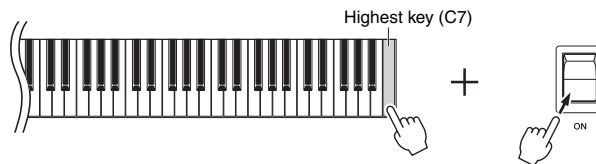

The display indicators flash in a pattern, indicating that the initialization is in process. When the operation is completed, the “ $\underline{L} \underline{L} \underline{r}$ ” indication appears.

### NOTICE

While the display indicators flash in a pattern (i.e., data is being initialized), never turn off the power.

### NOTE

If this instrument somehow becomes disabled or malfunctions, turn off the power to the instrument, then perform the initialization procedure.



# Connections

## ⚠ CAUTION

Before connecting the instrument to other electronic components, turn off the power to all the components. Before turning the power on or off to all components, set all volume levels to minimum (0). Otherwise, damage to the components, electrical shock, or even permanent hearing loss may occur.

Refer to the “Panel Controls and Terminals” on page 10 for information on the location of the connectors.

## Connecting Audio Devices ([AUX IN] jack, AUX OUT [L/L+R] [R] jacks)

### Playing a Portable Audio Player with the Built-in Speakers—[AUX IN] jack

You can connect the headphone jack of a portable audio player to the instrument’s [AUX IN] jack, letting you hear the sound of that audio player through the built-in speakers of the instrument.

#### NOTICE

To avoid damage to the devices, first turn on the power to the external device, then to the instrument. When turning off the power, first turn off the power to the instrument, then to the external device.

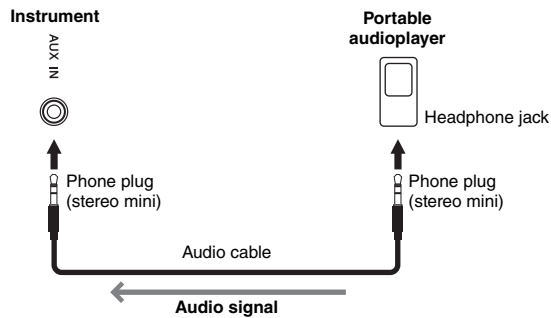

#### NOTE

Use audio cables and adaptor plugs having no (zero) resistance.

#### NOTE

The sound via the [AUX IN] jack is output only from the right and left speakers, and not from the center and rear speakers.

Default setting: ON

#### ● Minimizing noise of the input sound via Noise Gate

By default, this instrument cuts unwanted noise from the input sound. However, this may result in necessary sounds also being cut, such as the soft decay sound of a piano or guitar. To avoid this, set the Noise Gate to off via the following operation.

While holding down [FUNCTION], press the C#6 key repeatedly to toggle Noise Gate on and off as needed.

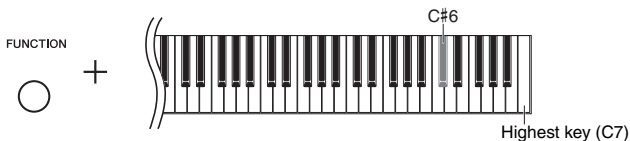

## Using an External Stereo System for Playback—AUX OUT [L/L+R] [R] jacks (unbalanced)

These jacks let you connect the instrument to external powered speaker systems, for playing in larger venues at higher volumes.

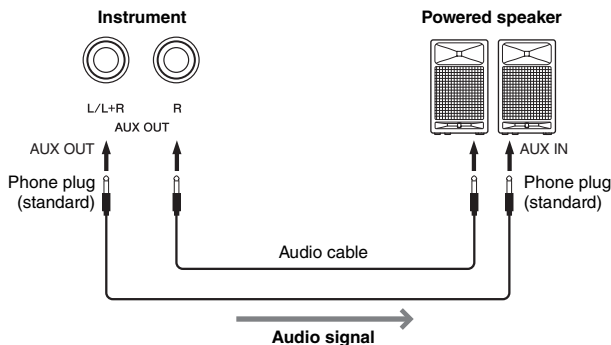

**NOTE**  
Use audio cables and adaptor plugs with no resistance.

**NOTE**  
Use only the AUX OUT [L/L+R] jack for connection with a mono device.

**NOTE**  
If you are monitoring the sound output via the AUX OUT [L/L+R] [R] jacks from headphones connected to the instrument, you should set "Binaural sampling/Stereophonic Optimizer" to "OFF." Refer to page 18 for details.

**NOTICE**

- To avoid possible damage to the devices, first turn on the power to the instrument, then to the external device. When turning off the power, first turn off the power to the external device, then to the instrument. Since this instrument's power may automatically be turned off due to the Auto Power Off function (page 16), turn off the power to the external device, or disable Auto Power Off when you do not intend to operate the instrument. If the instrument's power is automatically turned off via the Auto Power Off function, first turn off the external device, then turn on the power to the instrument then the external device again.
- When the AUX OUT jacks are connected to an external device, never connect the [AUX IN] jacks to the output jacks of the external device. Doing so could result in feedback (oscillation) that may damage both the devices.

## Connecting to a Mixer—OUTPUT [L] [R] jacks (Balanced)

In recording and live-performance environments, musical instruments are commonly connected to a mixer. For these applications, this instrument is equipped with a pair of professional-use, balanced XLR jacks that prevent unwanted noise in the output signals. When connecting to a mixer, we recommend using these OUTPUT [L] [R] jacks.

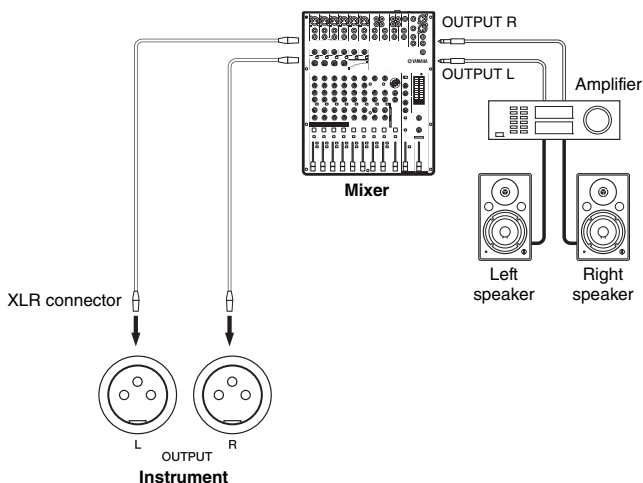

**NOTE**  
If you are monitoring the sound output via the OUTPUT [L] [R] jacks from headphones connected to the instrument, you should set "Binaural sampling/Stereophonic Optimizer" to "OFF." Refer to page 18 for details.

**NOTICE**

- To avoid possible damage to the devices, first turn on the power to the instrument, then to the external device. When turning off the power, first turn off the power to the external device, then to the instrument. Since this instrument's power may automatically be turned off due to the Auto Power Off function (page 16), turn off the power to the external device, or disable Auto Power Off when you do not intend to operate the instrument. If the instrument's power is automatically turned off via the Auto Power Off function, first turn off the external device, then turn on the power to the instrument then the external device again.
- When the OUTPUT jacks are connected to an external device, never connect the [AUX IN] jacks to the output jacks of the external device. Doing so could result in feedback (oscillation) that may damage both the devices.

### ● Fixed AUX OUT/OUTPUT Volume—AUX OUT [L/L+R] [R] jacks and OUTPUT [L] [R] jacks

By setting this parameter to “0n,” you can fix the volume of audio output via the AUX OUT [L/L+R] [R] and the OUTPUT [L] [R] jacks.

While holding down the [FUNCTION] button, press the D6 key repeatedly (if necessary) to turn Fixed AUX OUT/OUTPUT Volume on/off.

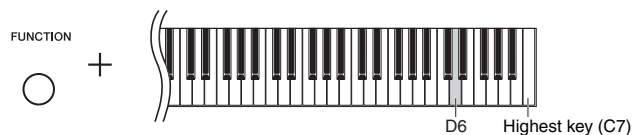

Display	Descriptions
0n	The volume of audio output is fixed and the [MASTER VOLUME] control has no effect.
0FF	The volume of audio output is adjusted by using the [MASTER VOLUME] control.

Default setting: OFF

## Connecting to a Computer ([USB TO HOST] terminal)

By connecting a computer to the [USB TO HOST] terminal, you can transfer Song data between the instrument and the computer via MIDI, and take advantage of sophisticated computer music software. For details, refer to the “Computer-related Operations” on the website (page 9).

Files that can be transferred from a computer to this instrument (and vice versa).

- Song file: .mid (SMF format 0, 1)

#### NOTE

Use an AB type USB cable of less than 3 meters. USB 3.0 cables cannot be used.

## Connecting to an iPhone/iPad (MIDI [IN] [OUT] connectors, [USB TO HOST] terminal)

You can use a smart device, such as an iPhone or iPad, with the instrument for a variety of musical purposes by connecting it to the instrument. By using application tools on your smart device, you can take advantage of convenient functions and get more enjoyment out of this instrument.

You can make connections by one of the following methods.

- Connect to the MIDI [IN] [OUT] connectors via the wireless MIDI adaptor (MD-BT01, sold separately).
- Connect to the [USB TO HOST] terminal via the wireless MIDI adaptor (UD-BT01, sold separately).

For details on connections, refer to the “iPhone/iPad Connection Manual” on the website (page 9). For information about the compatible smart devices and application tools, access the following page:

<https://www.yamaha.com/kbdapps/>

#### NOTICE

Do not place your iPhone/iPad in an unstable position. Doing so may cause the device to fall and result in damage.

#### NOTE

When you use the instrument along with an application on your iPhone or iPad, we recommend that you set “Airplane Mode” to “ON” on that device in order to avoid noise caused by communication.

#### NOTE

These accessories may not be available depending on your area.

## Connecting External MIDI Devices (MIDI [IN] [OUT] connectors)

MIDI (Musical Instrument Digital Interface) is a global format standard for performance data transmission and reception between electronic musical instruments. Connecting musical instruments that support MIDI via MIDI cables enables you to transfer performance and setting data between multiple musical instruments. Using MIDI, you can also achieve more advanced performances than using just a single musical instrument.

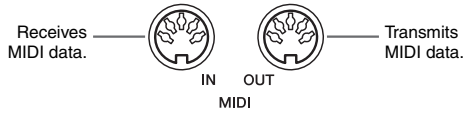

**NOTE**

You need a dedicated MIDI cable to make a MIDI connection.

**NOTE**

The handled MIDI messages differ depending on the MIDI instrument. In other words, some MIDI messages transmitted from this instrument may not be recognized on a different MIDI instrument. For details, you should check the MIDI Implementation Chart of each MIDI instrument. The MIDI Implementation Chart of this instrument is described in the "MIDI Reference" on the website (page 9).

**NOTE**

During Song playback, data of only MIDI channels 3–16 will be output via MIDI.

**NOTE**

Voice Demo Song and Preset Song data are not transmitted via MIDI.

### Example for MIDI connection

**Example 1:**

The connection below allows you to play the sounds of an external MIDI tone generator from the keyboard of this instrument.

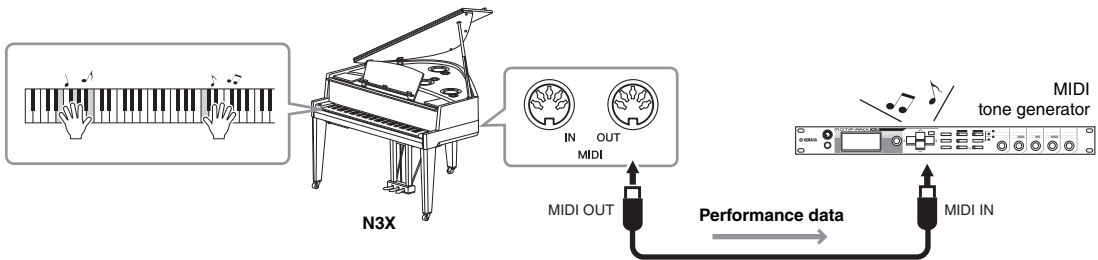

Set the MIDI Receive Channel of the external MIDI tone generator to "1," since the MIDI Transmit Channel of this instrument is set to "1."

**Example 2:**

The connection below allows you to play the sounds of this instrument by playing back a Song on an external sequencer.

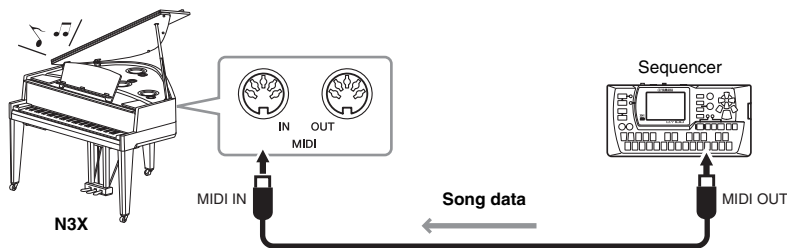

The MIDI Receive Channels of this instrument can only be set to 1 and 2. This is why the data for the piano part should be assigned to MIDI Channels 1 and 2 of the Song.

## Local Control on/off

---

Normally, playing the keyboard will control the internal tone generator. This situation is called “Local Control ON.” If you want to use the keyboard only for controlling an external MIDI instrument, turn off Local Control. With this setting, this instrument will produce no sound even if you play the keyboard.

### ● To turn the Local Control ON or OFF:

While holding down [FUNCTION], press the C6 key repeatedly (as necessary).

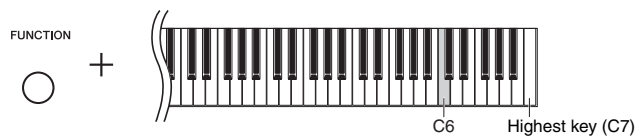

Default setting: ON

# Message List

Message	Descriptions
<i>CLr</i>	Displayed when the initialization (page 40) is completed.
<i>con</i>	Displayed when Musicsoft Downloader is started on a computer connected to the instrument. When this message appears, you cannot operate the instrument.
<i>EO1</i>	Displayed when the character code (page 33) is not appropriate for the file name of the Song which you are selecting. Switch the character code.
	Displayed when the data format is not compatible with this instrument, or the data has some other problems. This Song cannot be selected.
	Displayed when no USB flash drive can be found, or a problem has occurred in the USB flash drive. Disconnect and connect the device again, then execute the operation. If this message appears repeatedly even when there aren't any other likely problems, the USB flash drive may be damaged.
<i>EO2</i>	Indicates that the USB flash drive is protected.
<i>EO3</i>	Displayed when the memory of the USB flash drive becomes full, or the number of files and folders exceeds the system limit.
<i>EO4</i>	Displayed when Audio Song playback or recording has failed. If you are using a USB flash drive to which data has already been stored or deleted a number of times, first make sure that the device does not contain important data, then format it (page 37) and connect to the instrument again.
<i>EE1</i>	A malfunction has occurred in the instrument. Contact your nearest Yamaha dealer or authorized distributor.
<i>EEE</i>	A malfunction has occurred in the instrument. Contact your nearest Yamaha dealer or authorized distributor.
<i>End</i>	Displayed when the current operation is completed.
<i>EnP</i>	The memory of the instrument or the USB flash drive is running out. We recommend that you remove any unnecessary files (page 39) to ensure sufficient memory capacity before start recording.
<i>FUL</i>	The operation could not be completed because the instrument's internal memory or the USB flash drive is nearly full. If this message is shown while recording, your performance data may not be correctly saved.
<i>n Y</i>	Confirms whether each operation is executed or not.
<i>Pro</i>	Displayed when you try to overwrite or delete a protected Song or read-only file. Use a read-only file after cancelling the read-only setting.
<i>UnF</i>	Displayed when an unformatted USB flash drive is connected. First make sure that the device does not contain important data, then format it (page 37).
<i>Uoc</i>	Communication with the USB flash drive has been shut down because of overcurrent to the USB flash drive. Disconnect the USB flash drive from the [USB TO DEVICE] terminal, then turn on the power of the instrument again.
<i>UU1</i>	Communication with the USB flash drive has failed. Remove the USB flash drive and make the connection again. If the message appears even when the USB flash drive is connected properly, the USB flash drive may be damaged.
<i>UU2</i>	This USB flash drive is not supported on this instrument, or too many USB flash drives may have been connected. Refer to "About USB Flash Drives" (page 36) for information on the USB flash drive connection.

\* When an operation (such as saving or data transfer) is in process, the display shows a sequence of flashing dashes.

\* Press any button to exit from these message displays.

# Troubleshooting

Problem	Possible Cause and Solution
The instrument does not turn on.	The instrument has not been plugged in properly. Securely insert the female plug into the socket on the instrument, and the male plug into a proper AC outlet (page 14).
A click or pop is heard when the power is turned on or off.	Electrical current is being applied to the instrument. This is normal.
The power is automatically turned off.	This is normal and due to the Auto Power Off function. If necessary, set the parameter of the Auto Power Off function (page 16).
Noise is heard from the speakers or headphones.	The noise may be due to interference caused by the use of a mobile phone in close proximity to the instrument. Turn off the mobile phone, or use it further away from the instrument.
Noise is heard from the instrument's speakers or headphones when using the instrument with the application on iPhone/iPad.	When you use the instrument along with the application on your iPhone/iPad, we recommend that you set "Airplane Mode" to "ON" on your iPhone/iPad in order to avoid noise caused by communication.
The overall volume is low, or no sound is heard.	<ul style="list-style-type: none"> <li>• The Volume is set too low: set it to an appropriate level using the [MASTER VOLUME] control (page 17).</li> <li>• Make sure a pair of headphones is not connected to the headphones jack (page 18).</li> <li>• Make sure that Local Control (page 45) is on.</li> </ul>
Sound is still heard from the instrument even though headphones are plugged in.	When the TRS is on, sound can be heard slightly even if the headphones are connected. Turn the TRS off to mute all sound other than the headphones (page 25).
The pitch and/or tone of the Piano Voices in certain ranges do not sound right.	The Piano Voices attempt to precisely simulate actual piano sounds. However, as a result of sampling algorithms, overtones in some ranges may sound exaggerated, producing a somewhat different pitch or tone. This is normal, and no cause for concern.
Sound is not heard on a particular key.	Keyboard may not function normally if the key was pressed when the power was turned on. Turn off the power and turn it again to reset the function. Do not touch any keys when turning the power on (page 15).
Sound input to the [AUX IN] jacks is interrupted.	<p>The output volume of the external device connected to this instrument is too low, resulting in the sound being cut off via the Noise Gate after it is input to this instrument.</p> <ul style="list-style-type: none"> <li>• Increase the output volume of the external device. The volume level reproduced via this instrument's speakers can be adjusted by using the [MASTER VOLUME] control.</li> <li>• Set the Noise Gate to off (page 41).</li> </ul>
The damper pedal has no effect.	The pedal cord may not be properly connected. Make sure to securely insert the pedal cord into the pedal jack (page 51).
The USB flash drive has hung up (stopped).	<ul style="list-style-type: none"> <li>• Disconnect the USB flash drive and connect it to the instrument again.</li> <li>• The USB flash drive is not compatible with the instrument. Only use the USB flash drive whose compatibility has been confirmed by Yamaha (page 36).</li> </ul>
Mechanical noise is heard during performance.	The keyboard mechanism of this instrument simulates the keyboard mechanism of an actual piano. Mechanical noise is also heard on a piano.

\* The message list (page 46) is also provided for your reference.

# Preset Song List

---

Display	Song Name	Composer
<i>P.01</i>	Prelude op.3-2, Morceaux de fantaisie	S.Rakhmaninov
<i>P.02</i>	Mädchens Wunsch, 6 Chants polonaise	F.Liszt
<i>P.03</i>	Sonate für Klavier Nr.14 "Mondschein", op.27-2	L.v.Beethoven
<i>P.04</i>	Sonate für Klavier Nr.5, K.283	W.A.Mozart
<i>P.05</i>	Nocturne, op.9-1	F.F.Chopin
<i>P.06</i>	Sonate, K.380, L.23	D.Scarlatti
<i>P.07</i>	Valse, op.69-2	F.F.Chopin
<i>P.08</i>	Aria, Goldberg-Variationen, BWV.988	J.S.Bach
<i>P.09</i>	Fantaisie-Impromptu	F.F.Chopin
<i>P.10</i>	Clair de lune	C.A.Debussy



# Assembling the Unit

When assembling the unit, consult a qualified AvantGrand dealer.

**⚠ CAUTION**

- Be careful not to confuse parts, and be sure to install all parts in the correct orientation. Please assemble in accordance with the sequence given below.
- Assembly should be carried out by at least three persons.
- Be sure to use the correct screw size, as indicated below. Use of incorrect screws can damage the instrument.
- Be sure to tighten all screws upon completing the assembly of each unit.
- To disassemble, reverse the assembly sequence given below.

Have a Phillips-head (+) screwdriver of the appropriate size ready.

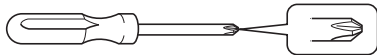

**⚠ CAUTION**

Do not lay the main unit upside down on the floor.

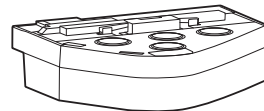

**Incorrect**

## 1 Remove the parts and collect them together for assembly.

1-1 Remove the parts shown below from the smaller box.

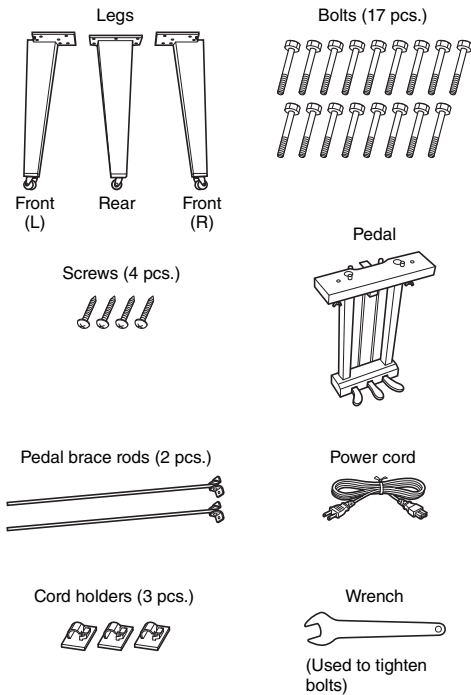

1-2 Set the larger box upright with the right side up.

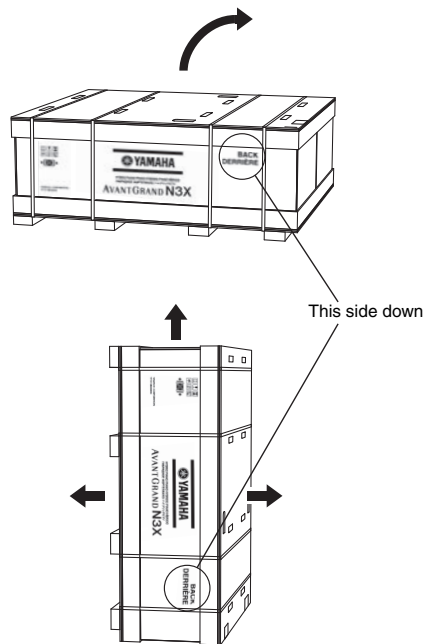

1-3 Cut the bands.

1-4 Remove the covers.

**2 Attach and securely tighten the right front leg and the rear leg with the bolts.**

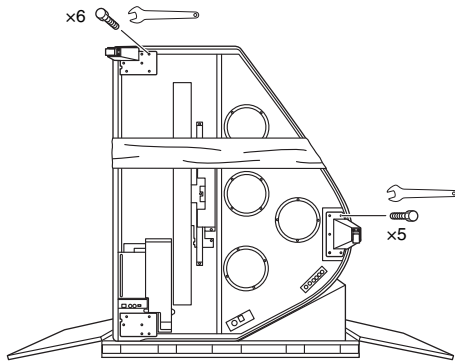

**CAUTION**  
When the instrument is set upright (as in the illustration above), take extra care not to keep the instrument from falling over, since it is unstable in this position.

**3 Set a blanket at the left corner.**

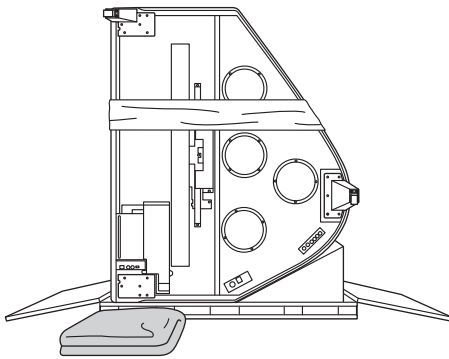

**4 Set the piano upright.**

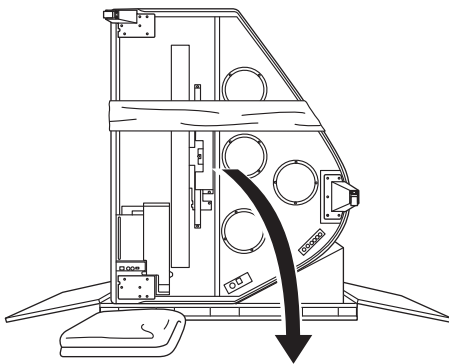

**5 Attach and securely tighten the left front leg with the bolts while holding the piano firmly.**

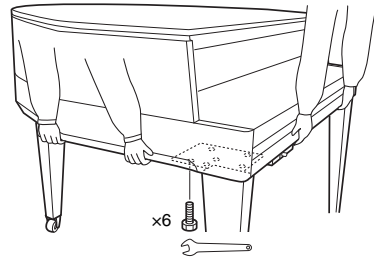

**CAUTION**  
Do not hold the control panel. Using excessive force on the panel can result in damage to the instrument.

**6 Attach the pedal brace rods.**

Find the threaded bores on the bottom of the unit, and securely tighten the screws to attach the rods.

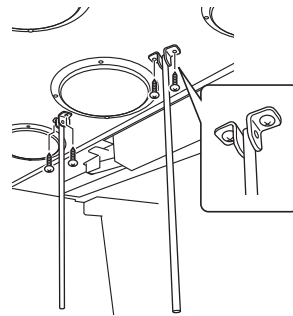

**7 Attach the pedal.**

Insert the pedal brace rods into the pedal box recesses and make sure they fit securely, then securely tighten the screws to attach the pedal.

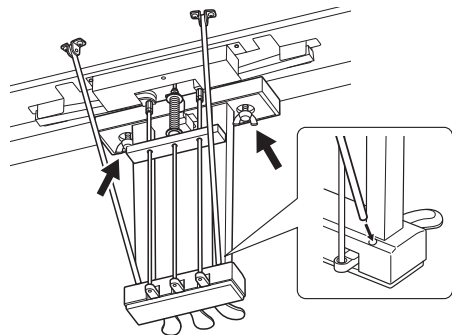

## 8 Connect the pedal cord.

- 8-1 Make sure the pedal cord is clipped into the cord holder.
- 8-2 Insert the pedal cord plug into the pedal jack.

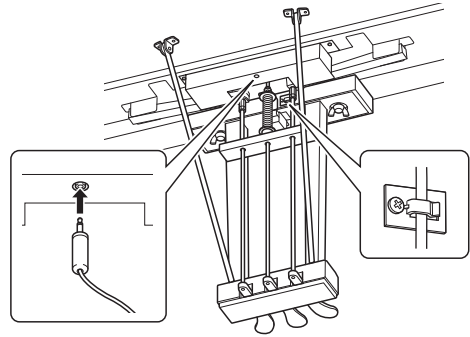

## 9 Connect the power cord.

- 9-1 Set the voltage selector and insert the power cord plug to the [AC IN] connector.
- 9-2 Attach the cord holders to the instrument, then clip the power cord into the holder.

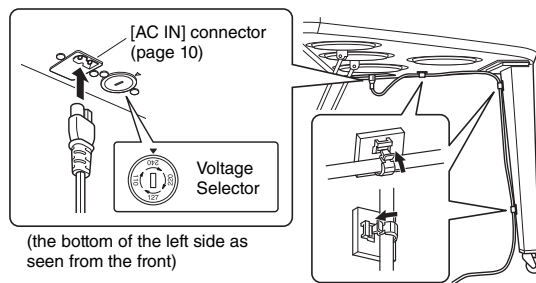

### Voltage Selector

Before connecting the AC power cord, check the setting of the voltage selector which is provided in some areas. To set the selector for 110V, 127V, 220V or 240V main voltages, use a “minus” screwdriver to rotate the selector dial so that the correct voltage for your region appears next to the pointer on the panel. The voltage selector is set at 240V when the unit is initially shipped. After the proper voltage has been selected, connect the AC power cord to the AC IN and an AC wall outlet. A plug adaptor may be also provided in some areas to match the pin configuration of the AC wall outlets in your area.

### **⚠ WARNING**

An improper voltage setting can cause serious damage to the instrument or result in improper operation.

### **⚠ CAUTION**

If the main unit creaks or is otherwise unsteady when you play on the keyboard, refer to the assembly diagrams and retighten all screws.

### After completing the assembly, please check the following.

- Are there any parts left over?  
→ Review the assembly procedure and correct any errors.
- Is the instrument clear of doors and other movable fixtures?  
→ Move the instrument to an appropriate location.
- Does the instrument make a rattling noise when you shake it?  
→ Tighten all screws.
- Is the power cord inserted securely into the sockets?  
→ Check the connection.
- Is the pedal unstable?  
→ Loosen the screws of the pedal brace rods, then tighten the screws again while pushing the rods toward the pedal.

# Specifications

Product Name		Hybrid Piano		
Size/Weight	Width	1,481 mm (58-5/16")		
	Height [Lid up]	1,014 mm (39-15/16") [1,734 mm (68-1/4")]		
	Depth	1,195 mm (47-1/16")		
	Weight	199 kg (438lbs., 12oz.)		
Control Interface	Keyboard	Number of Keys	88 (A-1 – C7)	
		White	Ivorite	
		Black	Phenolic resin	
		Touch Sensitivity	Hard/Medium/Soft/Fixed	
	Sensor System	Hammer Sensors	Non-contact optical fiber	
		Key Sensors	Non-contact optical fiber	
	Pedal	Number of Pedals	3	
		Functions Type	Damper (with half-pedal effect), Sostenuto, Soft Specialized Grand Piano Pedal for AvantGrand	
Tactile Response System (TRS)		Yes		
Cabinet	Fallboard	Yes		
	Music Rest	Yes (angle adjustable)		
Voices	Tone Generation	Piano Sound	Spatial Acoustic Sampling	
		Binaural Sampling	Yes (CFX Grand Voice only)	
	Piano Effect	VRM	Yes	
		Key-off Samples	Yes	
		Smooth Release	Yes	
	Polyphony	Number of Polyphony (max.)	256	
Preset	Number of Voices	10		
Effects	Types	Reverb	Yes	
		Brilliance	5	
		Intelligent Acoustic Control (IAC)	Yes	
		Stereophonic Optimizer	Yes	
Songs (MIDI)	Preset	Number of Preset Songs	10 preset songs, 10 voice demo songs	
	Recording	Number of Songs	10	
		Number of Tracks	1	
	Format	Data Capacity	approx. 550 KB/Song	
		Playback	SMF (Format 0, 1)	
Recording/ Playback (Audio)	Recording Time (max.)	Recording	SMF (Format 0)	
		Format	80 minutes/Song	
Functions	Overall Controls	Playback	WAV (44.1kHz, 16bit, stereo)	
		Recording	WAV (44.1kHz, 16bit, stereo)	
		Metronome	Yes	
		Tempo Range	5 – 500	
		Transpose	-6 – 0 – +6	
		Tuning	414.8 – 440.0 – 466.8 Hz	
Storage and Connectivity	Storage	Scale Type	7 types	
		Internal Memory	approx. 1.4 MB	
	Connectivity	External Drives	USB Flash Drive	
		Headphones	Standard stereo phone jack (x 2)	
		MIDI	IN/OUT	
		AUX IN	Stereo Mini	
		AUX OUT	[L/L+R] [R] (Standard phone jack, unbalanced)	
		OUTPUT	[L] [R] (XLR jack, balanced)	
		USB TO DEVICE	Yes	
		USB TO HOST	Yes	
Sound System	Spatial Acoustic Speaker System		Yes	
	Amplifiers	80 W x 2 + 45 W x 4 + 35 W x 5 + 25 W x 4		
	Speakers	(16 cm + 13 cm + 2.5 cm) x 4		
	Acoustic Optimizer	Yes		
	Soundboard Resonator	Yes		
Power Supply	Auto Power Off		Yes	
	Standby Power Consumption		0.3 W	
Included Accessories		Owner's Manual (this book) Power cord Warranty* Felt Key Cover Bench* Online Member Product Registration *May not be included depending on your area. Check with your Yamaha dealer.		
Separately Sold Accessories (May not be available depending on your area.)		Headphones (HPH-50/HPH-100/HPH-150) Wireless MIDI Adaptor (MD-BT01/UD-BT01)		

\* The contents of this manual apply to the latest specifications as of the publishing date. To obtain the latest manual, access the Yamaha website then download the manual file. Since specifications, equipment or separately sold accessories may not be the same in every locale, please check with your Yamaha dealer.

# Index

## A

AC IN .....	10, 14
Accessories .....	9
Assembly .....	49
Audio recording .....	34
Audio Song .....	31
Auto Power Off .....	16
AUX IN .....	41
AUX OUT .....	42

## B

Backup .....	40
Base Note .....	30
Beat .....	22
Binaural Sampling .....	18
Brilliance .....	27

## C

Character Code .....	33
Computer .....	43
Computer-related Operations .....	9
Connections .....	41
Copy .....	38

## D

Damper Resonance Depth .....	26
Data format .....	31
Delete .....	39
Demo Song .....	21
Demo Song List .....	21
Display .....	11

## E

External Song .....	31
---------------------	----

## F

Fallboard .....	12
Fast forward .....	33
Format (USB Flash Drive) .....	37

## H

Half-pedal .....	19
Headphones .....	18
Hz (Hertz) .....	29

## I

Initialization .....	40
Intelligent Acoustic Control (IAC) .....	17
iPhone/iPad .....	43
iPhone/iPad Connection Manual .....	9

## L

Lid .....	13
Lid stay .....	13
Local Control .....	45

## M

Master Volume .....	17
Message List .....	46
Metronome .....	22
MIDI .....	44
MIDI Basics .....	9
MIDI recording .....	34
MIDI Reference .....	9
MIDI Song .....	31
Music rest .....	12

## N

Noise Gate .....	41
------------------	----

## O

OUTPUT .....	42
--------------	----

## P

Pedal .....	19
Pitch .....	28
Playback (all) .....	32
Playback (Audio Song) .....	32
Playback (Demo Song) .....	21
Playback (MIDI Song) .....	32
Playback (Preset Song) .....	32
Playback (random) .....	32
Power .....	14–15
Precautions .....	5
Preset Song List .....	48

## Q

Quick Operation Guide .....	54
-----------------------------	----

## R

Recording .....	34
Reverb .....	27
Rewind .....	33

## S

Scale .....	30
Song .....	31
Song Category List .....	31
Specifications .....	52
Stereophonic Optimizer .....	18
String Resonance Depth .....	26

## T

Tactile Response System .....	25
Tempo .....	23
Touch Sensitivity .....	24
Transpose .....	28
Troubleshooting .....	47
TRS .....	25
Tuning .....	29

## U

USB flash drive .....	36
USB TO DEVICE .....	36
USB TO HOST .....	43
User Song .....	31

## V

Vibration .....	25
Virtual Resonance Modeling .....	26
Voice .....	20
Voice Demo Song .....	21
Voice List .....	20
Volume (Audio Songs) .....	33
Volume (AUX OUT/OUTPUT) .....	43
Volume (Master Volume) .....	17
Volume (Metronome volume) .....	22
VRM .....	26

# Quick Operation Guide

While holding down the button on the control panel, press one of the corresponding keys shown below to set parameters.

- 1** Audio Song Volume (page 33)
- 2** VRM (page 26)
- 3** Damper Resonance Depth (page 26)
- 4** String Resonance Depth (page 26)
- 5** Binaural Sampling/ Stereophonic Optimizer (page 18)
- 6** Touch Sensitivity (page 24)
- 7** Metronome Volume (page 22)
- 8** Metronome Beat (page 22)
- 9** Tempo (page 23)
- 10** IAC (page 17)
- 11** IAC Depth (page 17)
- 12** Brightness of the Sound (Brilliance) (page 27)
- 13** Transpose (page 28)
- 14** Base Note (page 30)
- 15** Scale (page 30)
- 16** Auto Power Off function (page 16)
- 17** Local Control (page 45)
- 18** AUX IN Noise Gate (page 41)
- 19** AUX OUT/OUTPUT Volume Fixed (page 43)

**1 Audio Song Volume**

DEMO/SONG

**2 VRM**

**3 Damper Resonance Depth**

**4 String Resonance Depth**

PIANO/VOICE

**7 Metronome Volume**

**8 Metronome Beat**

METRONOME

**10 IAC**

**11 IAC Depth**

**12 Brightness of the Sound (Brilliance)**

**13 Transpose**

FUNCTION

**5 Binaural Sampling/ Stereophonic Optimizer**

**6 Touch Sensitivity**

**9 Tempo**

**14 Base Note**

**15 Scale**

**16 Auto Power Off function**

**17 Local Control**

**18 AUX IN Noise Gate**

**19 AUX OUT/OUTPUT Volume Fixed**

MEMO



## Important Notice: Power management information for customers in European Economic Area (EEA), Switzerland and Turkey

### Remarque importante : Informations sur la gestion de l'alimentation pour les clients de l'Espace économique européen (EEE), de Suisse et de Turquie

Yamaha products are equipped with a power management function. Some products allow you to disable that function, or to extend the amount of time that elapses before the power is turned off or set to standby. In these cases, energy consumption will increase.	English
Yamaha-Produkte sind mit einer Power-Management-Funktion ausgestattet. Bei einigen Produkten können Sie diese Funktion ausschalten oder die Zeitdauer, die verstreicht, bis das Instrument ausgeschaltet oder in Bereitschaft versetzt wird, verlängern. In diesen Fällen erhöht sich der Energieverbrauch.	Deutsch
Les produits Yamaha sont équipés d'une fonction de gestion de l'alimentation. Certains produits vous permettent de désactiver cette fonction ou d'allonger le délai avant la mise hors tension ou la mise en veille. Dans ces cas, la consommation d'énergie augmente.	Français
Yamaha-producten zijn uitgerust met een energiebeheerfunctie. Bij sommige producten kunt u die functie uitschakelen of de tijd verlengen die verstrijkt voordat de stroom wordt uitgeschakeld of in stand-by wordt gezet. In deze gevallen zal het energieverbruik toenemen.	Nederlands
Los productos Yamaha están equipados con una función de administración de energía. Algunos productos permiten desactivar esa función o ampliar el tiempo que transcurre antes de apagar la alimentación o poner el producto en modo de espera. En estos casos, el consumo de energía aumentará.	Español
I prodotti Yamaha sono dotati di una funzione di gestione dell'alimentazione. Alcuni prodotti consentono di disattivare tale funzione o di estendere il periodo di tempo che trascorre prima che l'alimentazione venga spenta o impostata in standby. In questi casi, il consumo energetico aumenterà.	Italiano
Os produtos Yamaha são equipados com uma função de gerenciamento de energia. Alguns produtos permitem desativar essa função ou estender o tempo decorrido antes de se desligar ou entrar em standby. Nesses casos, o consumo de energia aumentará.	Português
Τα προϊόντα της Yamaha είναι εξοπλισμένα με μια λειτουργία διαχείρισης ισχύος. Ορισμένα προϊόντα σας δίνουν τη δυνατότητα να απενεργοποιείτε αυτή τη λειτουργία ή να επεκτείνετε το χρονικό διάστημα μέχρι την απενεργοποίηση ή τη θέση σε κατάσταση αναμονής. Σε αυτές τις περιπτώσεις, η κατανάλωση ενέργειας θα αυξηθεί.	Ελληνικά
Yamaha-produkterna är utrustade med en energihanteringsfunktion. För vissa produkter kan du inaktivera den funktionen eller för att förlänga tiden som förflutit innan strömmen stängs av eller ställs i vänteläge. I dessa fall ökar energiförbrukningen.	Svenska
Yamahas produkter har en strømstyringsfunktion. På nogle produkter er det muligt at deaktivere denne funktion eller at forlænge den tid, der går, før der slukkes for strømmen, eller sættes på standby. I disse tilfælde vil strømforbruget stige.	Dansk
Yamaha-tuotteet on varustettu virranhallintatoiminnolla. Joissakin tuotteissa voit poistaa toiminnon käytöstä tai pidentää aikaa, joka kuluu ennen virran katkaisemista tai valmiustilaan asettamista. Näissä tapauksissa energiankulutus kasvaa.	Suomi
Produkty Yamaha są wyposażone w funkcję zarządzania energią. Niektóre produkty umożliwiają wyłączenie tej funkcji lub wydłużenie czasu, jaki upływa do wyłączenia zasilania lub przejścia w tryb gotowości. W takich przypadkach zużycie energii wzrośnie.	Polski
Produkty Yamaha jsou vybaveny funkcí správy napájení. Některé produkty umožňují tuto funkci zakázat nebo prodloužit dobu, která má uběhnout před vypnutím napájení nebo pohotovostním režimem. V těchto případech se zvýší spotřeba elektřiny.	Čeština
A Yamaha terméknek energiamedzszment funkcióval vannak ellátva. Egyes terméknek lehetővé teszik, hogy letiltsa ezt a funkciót, vagy meghosszabbítsa a kikapcsolás vagy készenléti állapotba helyezés előtt eltelt időt. Ezekben az esetekben az energiafogyasztás növekedni fog.	Magyar
Yamaha tooted on varustatud toitehalduse funktsiooniga. Mõned tooted võimaldavad teil selle funktsiooni keelata või pikendada aega, mis möödub enne toite väljalülitamist või ooterežiimi seadmist. Sellistel juhtudel suureneb energiatarbimine.	Eesti
Yamaha izstrādājumi ir aprīkoti ar barošanas pārvaldības funkciju. Dažiem izstrādājumiem šo funkciju var atspējot vai paildzināt laiku, kam jāpaiet pirms barošanas atslēgšanas vai pāriešanas gaidstāves režīmā. Šādā gadījumā palielināsies enerģijas patēriņš.	Latviešu
„Yamaha“ gaminiuose yra energijos sąnaudų valdymo funkcija. Kai kurie gaminiai leidžia išjungti šią funkciją arba pratęsti laiką, praėjusį prieš išjungiant maitinimą arba įjungiant budėjimo režimą. Tokiais atvejais energijos suvartojimas padidės.	Lietuvių
Produkty spoločnosti Yamaha sú vybavené funkciou správy napájania. Niektoré produkty vám umožňujú túto funkciu vypnúť alebo predĺžiť čas, po uplynutí ktorých sa napájanie vypne alebo nastaví do pohotovostného režimu. V takýchto prípadoch sa zvýši spotreba energie.	Slovenčina
Yamahini izdelki imajo funkcijo upravljanja z napajanjem. Nekateri izdelki vam omogočajo, da onemogočite to funkcijo ali podaljšate čas, ki mora preteči, preden se napajanje izklopi ali nastavi v stanje pripravljenosti. V teh primerih se bo poraba energije povečala.	Slovenščina
Продуктите на Yamaha са снабдени с функция за управление на захранването. Някои продукти ви позволяват да забраните тази функция или да удължите времето, което ще изтече, преди захранването да се изключи или да се настрои в режим на готовност. В тези случаи консумацията на енергия ще се увеличи.	Български
Produsele Yamaha sunt echipate cu o funcție de gestionare a energiei. Unele produse vă permit să dezactivați această funcție sau să prelungiți perioada de timp care trece înainte ca alimentarea să fie oprită sau setată în standby. În aceste cazuri, consumul de energie va crește.	Română
Yamaha proizvodi opremljeni su funkcijom upravljanja potrošnjom energije. Neki vam proizvodi omogućuju onemogućavanje te funkcije ili produženje vremena koje protekne prije isključivanja napajanja ili postavljanja u stanje pripravnosti. U tim će se slučajevima povećati potrošnja energije.	Hrvatski
Yamaha ürünlerinde güç yönetimi işlevi vardır. Bazı ürünler, bu işlevi devre dışı bırakmanıza veya güç kapatılmadan ya da bekleme moduna alınmadan önce geçen süreyi uzatmanıza olanak tanır. Bu gibi durumlarda, enerji tüketimi artacaktır.	Türkçe

(574-M06 EU erp 01)



### Information for users on collection and disposal of old equipment:



This symbol on the products, packaging, and/or accompanying documents means that used electrical and electronic products should not be mixed with general household waste.

For proper treatment, recovery and recycling of old products, please take them to applicable collection points, in accordance with your national legislation.

By disposing of these products correctly, you will help to save valuable resources and prevent any potential negative effects on human health and the environment which could otherwise arise from inappropriate waste handling.

For more information about collection and recycling of old products, please contact your local municipality, your waste disposal service or the point of sale where you purchased the items.

#### For business users in the European Union:

If you wish to discard electrical and electronic equipment, please contact your dealer or supplier for further information.

#### Information on Disposal in other Countries outside the European Union:

This symbol is only valid in the European Union. If you wish to discard these items, please contact your local authorities or dealer and ask for the correct method of disposal.

(weee\_eu\_en\_02)

### Informations concernant la collecte et le traitement des déchets d'équipements électriques et électroniques



Le symbole sur les produits, l'emballage et/ou les documents joints signifie que les produits électriques ou électroniques usagés ne doivent pas être mélangés avec les déchets domestiques habituels.

Pour un traitement, une récupération et un recyclage appropriés des déchets d'équipements électriques et électroniques, veuillez les déposer aux points de collecte prévus à cet effet, conformément à la réglementation nationale.

En vous débarrassant correctement des déchets d'équipements électriques et électroniques, vous contribuerez à la sauvegarde de précieuses ressources et à la prévention de potentiels effets négatifs sur la santé humaine qui pourraient advenir lors d'un traitement inapproprié des déchets.

Pour plus d'informations à propos de la collecte et du recyclage des déchets d'équipements électriques et électroniques, veuillez contacter votre municipalité, votre service de traitement des déchets ou le point de vente où vous avez acheté les produits.

#### Pour les professionnels dans l'Union européenne :

Si vous souhaitez vous débarrasser des déchets d'équipements électriques et électroniques, veuillez contacter votre vendeur ou fournisseur pour plus d'informations.

#### Informations sur la mise au rebut dans d'autres pays en dehors de l'Union européenne :

Ce symbole est seulement valable dans l'Union européenne. Si vous souhaitez vous débarrasser de déchets d'équipements électriques et électroniques, veuillez contacter les autorités locales ou votre fournisseur et demander la méthode de traitement appropriée.

(weee\_eu\_fr\_02)

### Información para usuarios sobre la recogida y eliminación de los equipos antiguos



Este símbolo en los productos, embalajes y documentos anexos significa que los productos eléctricos y electrónicos no deben mezclarse con los desperdicios domésticos normales.

Para el tratamiento, recuperación y reciclaje apropiados de los productos antiguos, llévelos a puntos de reciclaje correspondientes, de acuerdo con la legislación nacional.

Al deshacerse de estos productos de forma correcta, ayudará a ahorrar recursos valiosos y a impedir los posibles efectos desfavorables en la salud humana y en el entorno que de otro modo se producirían si se trataran los desperdicios de modo inapropiado.

Para obtener más información acerca de la recogida y el reciclaje de los productos antiguos, póngase en contacto con las autoridades locales, con el servicio de eliminación de basuras o con el punto de venta donde adquirió los artículos.

#### Para los usuarios empresariales de la Unión Europea:

Si desea desechar equipos eléctricos y electrónicos, póngase en contacto con su vendedor o proveedor para obtener más información.

#### Información sobre la eliminación en otros países fuera de la Unión Europea:

Este símbolo solo es válido en la Unión Europea. Si desea desechar estos artículos, póngase en contacto con las autoridades locales o con el vendedor y pregúnteles el método correcto.

(weee\_eu\_es\_02)

# Important Notice: Guarantee Information for customers in European Economic Area (EEA) and Switzerland

<b>Important Notice: Guarantee Information for customers in EEA* and Switzerland</b> For detailed guarantee information about this Yamaha product, and Pan-EWR** and Switzerland warranty service, please either visit the website address below. (Printable file is available at our website) or contact the Yamaha representative office for your country. * EEA: European Economic Area	<b>English</b>
<b>Wichtiger Hinweis: Garantie-Information für Kunden in der EWR* und der Schweiz</b> Für nähere Garantie-Information über dieses Produkt von Yamaha, sowie über den Pan-EWR** und Schweizer Garantieservice, besuchen Sie bitte entweder die folgend angegebene Internetadresse (eine druckfähige Version befindet sich auch auf unserer Webseite), oder wenden Sie sich an den für Ihr Land zuständigen Yamaha-Vertrieb. *EWR: Europäische Wirtschaftszraum	<b>Deutsch</b>
<b>Remarque importante: informations de garantie pour les clients de l'EEE et de la Suisse</b> Pour des informations plus détaillées sur la garantie de ce produit Yamaha et sur le service de garantie applicable dans l'ensemble de l'EEE ainsi qu'en Suisse, consultez notre site Web à l'adresse ci-dessous (le fichier imprimable est disponible sur notre site Web) ou contactez directement Yamaha dans votre pays de résidence. * EEE : Espace Economique Européen	<b>Français</b>
<b>Belangrijke mededeling: Garantie-informatie voor klanten in de EER* en Zwitserland</b> Voor gedetailleerde garantie-informatie over dit Yamaha-product en de garantieservice in heel de EER* en Zwitserland, gaat u naar de onderstaande website (u vindt een afdrukbare bestaand op onze website) of neemt u contact op met de vertegenwoordiging van Yamaha in uw land. * EER: Europese Economische Ruimte	<b>Nederlands</b>
<b>Aviso importante: información sobre la garantía para los clientes del EEE* y Suiza</b> Para una información detallada sobre este producto Yamaha y sobre el soporte de garantía en la zona EEE* y Suiza, visite la dirección web que se incluye más abajo (la versión del archivo para imprimir está disponible en nuestro sitio web) o póngase en contacto con el representante de Yamaha en su país. * EEE: Espacio Económico Europeo	<b>Español</b>
<b>Aviso importante: informazioni sulla garanzia per i clienti residenti nell'EEA* e in Svizzera</b> Per informazioni dettagliate sulla garanzia relativa a questo prodotto Yamaha e l'assistenza in garanzia nei paesi EEA* e in Svizzera, potete consultare il sito Web all'indirizzo riportato di seguito (è disponibile il file in formato stampabile) oppure contattate l'ufficio di rappresentanza locale della Yamaha. * EEA: Area Economica Europea	<b>Italiano</b>
<b>Aviso importante: informações sobre as garantias para clientes da AEE* e da Suíça</b> Para obter uma informação pormenorizada sobre este produto da Yamaha e sobre o serviço de garantia na AEE* e na Suíça, visite o site a seguir (o arquivo para impressão está disponível no nosso site) ou entre em contato com o escritório de representação da Yamaha no seu país. * AEE: Área Económica Europeia	<b>Portugués</b>
<b>Σημαντική σημείωση: Πληροφορίες εγγύησης για τους πελάτες στον ΕΟΧ* και Ελβετία</b> Για λεπτομερείς πληροφορίες εγγύησης σχετικά με το παρόν προϊόν της Yamaha και την κάλυψη εγγύησης σε όλες τις χώρες του ΕΟΧ και την Ελβετία, επισκεφτείτε την παρακάτω ιστοσελίδα (Εκτυπιώσιμη μορφή είναι διαθέσιμη στην ιστοσελίδα μας) ή απευθυνθείτε στην αντιπροσωπεία της Yamaha στη χώρα σας. * ΕΟΧ: Ευρωπαϊκός Οικονομικός Χώρος	<b>Ελληνικά</b>
<b>Viktig: Garantierinformation för kunder i EES-området* och Schweiz</b> För detaljerad information om denna Yamahaprodukt samt garantiservice i hela EES-området* och Schweiz kan du antingen besöka nedanstående webbadress (en utskriftsvänlig fil finns på webbplatsen) eller kontakta Yamahas officiella representant i ditt land. * EES: Europeiska Ekonomiska Samarbetsområdet	<b>Svenska</b>
<b>Viktig merknad: Garantierinformasjon for kunder i EØS* og Sveits</b> De kan finne detaljerte garantieroplysninger om dette Yamaha-produktet og garantiservice for hele EØS-området* og Sveits kan fås enten ved å besøke nettsidene nedenfor (utskriftsversjon finnes på våre nettsider) eller kontakte Yamahas-kontoret i landet der du bor. *EØS: Det europeiske økonomiske samarbeidsområdet	<b>Norsk</b>
<b>Viktig oplysning: Garantieroplysninger til kunder i EØO* og Schweiz</b> De kan finne detaljerte garantieroplysninger om dette Yamaha-produkt og den fælles garantieroplysning for EØO* (og Schweiz) ved at besøge det websted, der er angivet nedenfor (der findes en fil, som kan udskrives, på vores websted), eller ved at kontakte Yamahas nationale repræsentationskontor i det land, hvor De bor. * EØO: Det Europæiske Økonomiske Område	<b>Dansk</b>

<b>Tärkeä ilmoitus: Taku tiedot Euroopan talousalueen (ETA)* ja Sveitsin asiakkaille</b> Tämä on Yamaha-tuotteen sekä ET-alueen ja Sveitsin takuuta koskevat yksityiskohtaiset tiedot, saatte alla olevasta nettiosoitteesta. (Tulostettava tiedosto saatavissa suostolamme.) Voititte myös ottaa yhteyttä paikalliseen Yamahan edustajaan. *ETA: Euroopan talousalue	<b>Suomi</b>
<b>Ważne: Warunki gwarancyjne obowiązujące w EOG* i Szwajcarii</b> Aby dowiedzieć się więcej na temat warunków gwarancyjnych tego produktu firmy Yamaha i serwisu gwarancyjnego w całym EOG* i Szwajcarii, należy odwiedzić wskazaną poniżej stronę internetową (plik gotowy do wydruku znajduje się na naszej stronie internetowej) lub skontaktować się z przedstawicielstwem firmy Yamaha w swoim kraju. * EOG — Europejski Obszar Gospodarczy	<b>Polski</b>
<b>Důležitá oznámení: Záruční informace pro zákazníky v EHS* a ve Švýcarsku</b> Podrobné zprávy o informacích o tomto produktu Yamaha a zručním servisu v celém EHS* a ve Švýcarsku naleznete na níže uvedené webové adrese (soubor k tisku je dostupný na našich webových stránkách) nebo se můžete obrátit na zastoupení firmy Yamaha ve své zemi. * EHS: Evropský hospodářský prostor	<b>Česky</b>
<b>Fontos figyelmeztetés: Garancia-információk az EGT* területén és Svájcban élő vásárlók számára</b> A jelen Yamaha termékre vonatkozó részletes garancia-információk, valamint az EGT*-re és Svájcra kiterjedő garancia- és szolgálati feltételeket keresse fel webhelyünkön az alábbi címen (a webhelyen nyomtatható fájl is talál), vagy pedig lépjen kapcsolatba az országában működő Yamaha képviselői részével. * EGT: Európai Gazdasági Térség	<b>Magyar</b>
<b>Oluline märkus: Garantiteave Euroopa Majanduspiirkonna (EMP)* ja Šveitsi klientidele</b> Täpsemat teabe saamiseks selle Yamaha toote garantii ning kogu Euroopa Majanduspiirkonna ja Šveitsi garantiteeninduse kohta, külastage palun veebisaiti alljärgneval aadressil (meie saidil on saadaval printitav fail) või pöörduge Teie regiooni Yamaha esinduse poole. * EMP: Euroopa Majanduspiirkond	<b>Eesti keel</b>
<b>Svarīgs paziņojums: garantijas informācija klientiem EEZ* un Šveicē</b> Lai saņemtu detalizētāku garantijas informāciju par šo Yamaha produktu, kā arī garantijas apakšosānu EEZ* un Šveicē, lūdzam apmeklēt Yamaha norādīto tīmekļa vietnes adresi (tīmekļa vietnē ir pieejams drukājams fails) vai sazināties ar jūsu valstī apkalpojošo Yamaha pārstāvniecību. * EEZ: Eiropas Ekonomikas zona	<b>Latviešu</b>
<b>Děmesio: informacija dėl garantijos pirkėjams EEE* ir Šveicarijoje</b> Jei reikia išsamios informacijos apie šį „Yamaha“ produktą ir jo techninę priežiūrą, visoje EEE* ir Šveicarijoje, apsilankykite mūsų svetainėje toliau nurodyto adresu (svetainėje yra spausdinamas failas) arba kreipkitės į „Yamaha“ atstovybę savo šalyje. *EEE – Europos ekonominė erdvė	<b>Lietuvių kalba</b>
<b>Dôležité upozornenie: Informácie o záruke pre zákazníkov v EHP* a Švajčiarsku</b> Podrobné informácie o záruke týkajúce sa tohto produktu od spoločnosti Yamaha a garancijnom servise v EHP* a Švajčiarsku nájdete na webovej stránke uvedenej nižšie (na našej webovej stránke je k dispozícii súbor na tlač) alebo sa obráťte na zástupcu spoločnosti Yamaha vo svojej krajine. * EHP: Európsky hospodársky priestor	<b>Slovenčina</b>
<b>Pomembno obvestilo: Informacije o garanciji za kupce v EGP* in Švici</b> Ponudimo informacije o tem Yamahinim izdelkih ter garancijskem servisu v celotnem EGP in Švici, obiščite spletno mesto, ki je navedeno spodaj (našljajva datoteka je na voljo na našem spletnem mestu), ali se obrnite na Yamahinega predstavnika v svoji državi. * EGP: Evropski gospodarski prostor	<b>Slovenščina</b>
<b>Важно съобщение: Информация за гаранцията за клиентите в ЕИП* и Швейцария</b> За подробна информация за гаранцията за този продукт на Yamaha и гаранционното обслужване в паневропейската зона на ЕИП* и Швейцария или посетете посочения по-долу уеб сайт (на нашия уеб сайт има файл за печат), или се свържете с представителния офис на Yamaha във вашата страна. * ЕИП: Европейско икономическо пространство	<b>Български език</b>
<b>Notificare importantă: Informații despre garanție pentru clienții din SEE* și Elveția</b> Pentru informații detaliate privind acest produs Yamaha și serviciile de garanție Pan-SEE* și Elveția, vizitați site-ul la adresa de mai jos (fișierul imprimabil este disponibil pe site-ul nostru) sau contactați biroul reprezentanței Yamaha din țara dumneavoastră. * SEE: Spațiul Economic European	<b>Limba română</b>
<b>Važna obavijest: Informacije o jamstvu za države EGP-a i Švicarske</b> Za detaljne informacije o jamstvu za ovaj Yamahin proizvod te jamstvenom servisu za cijeli EGP i Švicarsku, molimo Vas da posjetite web-stranicu navedenu u nastavku ili kontaktirate ovlaštenog Yamahinog dobavljača u svojoj zemlji. * EGP: Evropski gospodarski prostor	<b>Hrvatski</b>

<https://europe.yamaha.com/warranty/>

# Yamaha Worldwide Representative Offices

## English

For details on the product(s), contact your nearest Yamaha representative or the authorized distributor, found by accessing the 2D barcode below.

## Deutsch

Wenden Sie sich für nähere Informationen zu Produkten an eine Yamaha-Vertretung oder einen autorisierten Händler in Ihrer Nähe. Diese finden Sie mithilfe des unten abgebildeten 2D-Strichcodes.

## Français

Pour obtenir des informations sur le ou les produits, contactez votre représentant ou revendeur agréé Yamaha le plus proche. Vous le trouverez à l'aide du code-barres 2D ci-dessous.

## Español

Para ver información detallada sobre el producto, contacte con su representante o distribuidor autorizado Yamaha más cercano. Lo encontrará escaneando el siguiente código de barras 2D.

## Português

Para mais informações sobre o(s) produto(s), fale com seu representante da Yamaha mais próximo ou com o distribuidor autorizado acessando o código de barras 2D abaixo.

## Italiano

Per dettagli sui prodotti, contattare il rappresentante Yamaha o il distributore autorizzato più vicino, che è possibile trovare tramite il codice a barre 2D in basso.

## Nederlands

Neem voor meer informatie over de producten contact op met uw dichtstbijzijnde Yamaha-vertegenwoordiger of de geautoriseerde distributeur, te vinden via de onderstaande 2D-barcode.

## Polski

Aby uzyskać szczegółowe informacje na temat produktów, skontaktuj się z najbliższym przedstawicielem firmy Yamaha lub autoryzowanym dystrybutorem, którego znajdziesz za pośrednictwem poniższego kodu kreskowego 2D.

## Русский

Чтобы узнать подробнее о продукте (продуктах), свяжитесь с ближайшим представителем или авторизованным дистрибьютором Yamaha, воспользовавшись двухмерным штрихкодом ниже.

## Dansk

Hvis du vil have detaljer om produktet/produkterne, kan du kontakte den nærmeste Yamaha-repræsentant eller autoriserede Yamaha-distributør, som du finder ved at scanne 2D-stregkode nedenfor.

## Svenska

Om du vill ha mer information om produkterna kan du kontakta närmaste Yamaha-representant eller auktoriserade distributör med hjälp av 2D-streckkoden nedan.

## Čeština

Podrobnosti o produktu(ech) získáte od nejbližšího zástupce společnosti Yamaha nebo autorizovaného distributora, který byl nalezen při použití 2D čárového kódu níže.

## Slovenčina

Podrobné informácie o produkte(-och) vám poskytne najbližší zástupca spoločnosti Yamaha alebo autorizovaný distribútor, ktorého nájdete pomocou nižšie uvedeného 2D čiarového kódu.

## Magyar

A termék(ek)re vonatkozó részletekért forduljon a legközelebbi Yamaha képviselőhöz vagy a hivatalos forgalmazóhoz, amelyet az alábbi 2D vonalkód segítségével találhat meg.

## Slovenščina

Če želite podrobnejše informacije o izdelkih, se obrnite na najbližjega Yamahinega predstavnika ali pooblaščenega distributerja, ki ga najdete prek 2D-kode v nadaljevanju.

## Български

За подробности относно продукта/ите се свържете с най-близкия представител на Yamaha или оторизиран дистрибутор, който можете да откриете, като използвате 2D баркода по-долу.

## Română

Pentru detalii privind produsele, contactați cel mai apropiat reprezentant Yamaha sau distribuitorul autorizat, pe care îl puteți găsi accesând codul de bare 2D de mai jos.

## Latviešu

Lai iegūtu plašāku informāciju par izstrādājumiem, sazinieties ar tuvāko Yamaha pārstāvi vai pilnvaroto izplatītāju, kuru atradīsiet, izmantojot tālāk pieejamo 2D svītrkodu.

## Lietuvių

Norėdami gauti daugiau informacijos apie gaminį (-ius), kreipkitės į artimiausią „Yamaha“ atstovą arba įgaliotąjį platintoją, kurį rasite nuskaitę toliau pateiktą 2D brūkšninį kodą.

## Eesti

Toodete kohta täpsema teabe saamiseks võtke ühendust lähima Yamaha esindaja või autoriseeritud levitajaga, kelle leiate allpool asuva 2D-võõtkoodi kaudu.

## Hrvatski

Za detalje o proizvodima obratite se lokalnom predstavku ili ovlaštenom distributeru tvrtke Yamaha, kojeg možete pronaći skeniranjem 2D crtičnog koda u nastavku.

## Türkçe

Ürünler hakkında ayrıntılar için, aşağıdaki 2D kodlu motora erişerek bulunan size en yakın Yamaha temsilcisine veya yetkili bayiye başvurun.



[https://manual.yamaha.com/mi/address\\_list/](https://manual.yamaha.com/mi/address_list/)

Head Office/Manufacturer: Yamaha Corporation 10-1, Nakazawa-cho, Chuo-ku, Hamamatsu, 430-8650, Japan

Importer (European Union): Yamaha Music Europe GmbH Siemensstrasse 22-34, 25462 Rellingen, Germany

Importer (United Kingdom): Yamaha Music Europe GmbH (UK) Sherbourne Drive, Tilbrook, Milton Keynes, MK7 8BL, United Kingdom

DMI37\_22m

Yamaha Global Site  
<https://www.yamaha.com/>

Yamaha Downloads  
<https://download.yamaha.com/>

© 2016 Yamaha Corporation  
Published 03/2025  
KSMA-B0



ZT86740