



RX-V3900

AV Receiver

OWNER'S MANUAL

IMPORTANT SAFETY INSTRUCTIONS

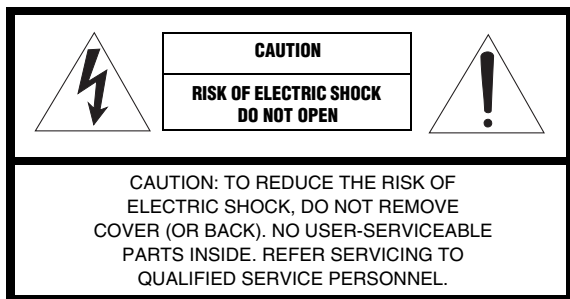

• Explanation of Graphical Symbols



The lightning flash with arrowhead symbol, within an equilateral triangle, is intended to alert you to the presence of uninsulated “dangerous voltage” within the product’s enclosure that may be of sufficient magnitude to constitute a risk of electric shock to persons.



The exclamation point within an equilateral triangle is intended to alert you to the presence of important operating and maintenance (servicing) instructions in the literature accompanying the appliance.

Note to CATV system installer:

This reminder is provided to call the CATV system installer’s attention to Article 820-40 of the NEC that provides guidelines for proper grounding and, in particular, specifies that the cable ground shall be connected to the grounding system of the building, as close to the point of cable entry as practical.

- 1 Read these instructions.
- 2 Keep these instructions.
- 3 Heed all warnings.
- 4 Follow all instructions.
- 5 Do not use this apparatus near water.
- 6 Clean only with dry cloth.
- 7 Do not block any ventilation openings. Install in accordance with the manufacturer’s instructions.
- 8 Do not install near any heat sources such as radiators, heat registers, stoves, or other apparatus (including amplifiers) that produce heat.
- 9 Do not defeat the safety purpose of the polarized or grounding-type plug. A polarized plug has two blades with one wider than the other. A grounding type plug has two blades and a third grounding prong. The wide blade or the third prong are provided for your safety. If the provided plug does not fit into your outlet, consult an electrician for replacement of the obsolete outlet.
- 10 Protect the power cord from being walked on or pinched particularly at plugs, convenience receptacles, and the point where they exit from the apparatus.
- 11 Only use attachments/accessories specified by the manufacturer.
- 12 Use only with the cart, stand, tripod, bracket, or table specified by the manufacturer, or sold with the apparatus. When a cart is used, use caution when moving the cart/apparatus combination to avoid injury from tip-over.
- 13 Unplug this apparatus during lightning storms or when unused for long periods of time.
- 14 Refer all servicing to qualified service personnel. Servicing is required when the apparatus has been damaged in any way, such as power-supply cord or plug is damaged, liquid has been spilled or objects have fallen into the apparatus, the apparatus has been exposed to rain or moisture, does not operate normally, or has been dropped.



FCC INFORMATION (for US customers)

1 IMPORTANT NOTICE: DO NOT MODIFY THIS UNIT!

This product, when installed as indicated in the instructions contained in this manual, meets FCC requirements. Modifications not expressly approved by Yamaha may void your authority, granted by the FCC, to use the product.

- 2 **IMPORTANT:** When connecting this product to accessories and/or another product use only high quality shielded cables. Cable/s supplied with this product **MUST** be used. Follow all installation instructions. Failure to follow instructions could void your FCC authorization to use this product in the USA.

- 3 **NOTE:** This product has been tested and found to comply with the requirements listed in FCC Regulations, Part 15 for Class “B” digital devices. Compliance with these requirements provides a reasonable level of assurance that your use of this product in a residential environment will not result in harmful interference with other electronic devices.

This equipment generates/uses radio frequencies and, if not installed and used according to the instructions found in the users manual, may cause interference harmful to the operation of other electronic devices.

Compliance with FCC regulations does not guarantee that interference will not occur in all installations. If this product is found to be the source of interference, which can be determined by turning the unit “OFF” and “ON”, please try to eliminate the problem by using one of the following measures:

Relocate either this product or the device that is being affected by the interference.

Utilize power outlets that are on different branch (circuit breaker or fuse) circuits or install AC line filter/s.

In the case of radio or TV interference, relocate/reorient the antenna. If the antenna lead-in is 300 ohm ribbon lead, change the lead-in to coaxial type cable.

If these corrective measures do not produce satisfactory results, please contact the local retailer authorized to distribute this type of product. If you can not locate the appropriate retailer, please contact Yamaha Electronics Corp., U.S.A. 6660 Orangethorpe Ave, Buena Park, CA 90620.

The above statements apply **ONLY** to those products distributed by Yamaha Corporation of America or its subsidiaries.

Caution: Read this before operating your unit.

- 1 To assure the finest performance, please read this manual carefully. Keep it in a safe place for future reference.
- 2 Install this sound system in a well ventilated, cool, dry, clean place – away from direct sunlight, heat sources, vibration, dust, moisture, and/or cold. Allow ventilation space of at least 30 cm on the top, 20 cm on the left and right, and 20 cm on the back of this unit.
- 3 Locate this unit away from other electrical appliances, motors, or transformers to avoid humming sounds.
- 4 Do not expose this unit to sudden temperature changes from cold to hot, and do not locate this unit in an environment with high humidity (i.e. a room with a humidifier) to prevent condensation inside this unit, which may cause an electrical shock, fire, damage to this unit, and/or personal injury.
- 5 Avoid installing this unit where foreign objects may fall onto this unit and/or this unit may be exposed to liquid dripping or splashing. On the top of this unit, do not place:
 - Other components, as they may cause damage and/or discoloration on the surface of this unit.
 - Burning objects (i.e. candles), as they may cause fire, damage to this unit, and/or personal injury.
 - Containers with liquid in them, as they may fall and liquid may cause electrical shock to the user and/or damage to this unit.
- 6 Do not cover this unit with a newspaper, tablecloth, curtain, etc. in order not to obstruct heat radiation. If the temperature inside this unit rises, it may cause fire, damage to this unit, and/or personal injury.
- 7 Do not plug in this unit to a wall outlet until all connections are complete.
- 8 Do not operate this unit upside-down. It may overheat, possibly causing damage.
- 9 Do not use force on switches, knobs and/or cords.
- 10 When disconnecting the power cable from the wall outlet, grasp the plug; do not pull the cable.
- 11 Do not clean this unit with chemical solvents; this might damage the finish. Use a clean, dry cloth.
- 12 Only voltage specified on this unit must be used. Using this unit with a higher voltage than specified is dangerous and may cause fire, damage to this unit, and/or personal injury. Yamaha will not be held responsible for any damage resulting from use of this unit with a voltage other than specified.
- 13 To prevent damage by lightning, keep the power cord and outdoor antennas disconnected from a wall outlet or the unit during a lightning storm.
- 14 Do not attempt to modify or fix this unit. Contact qualified Yamaha service personnel when any service is needed. The cabinet should never be opened for any reasons.
- 15 When not planning to use this unit for long periods of time (i.e. vacation), disconnect the AC power plug from the wall outlet.
- 16 Install this unit near the AC outlet and where the AC power plug can be reached easily.
- 17 Be sure to read the “Troubleshooting” section on common operating errors before concluding that this unit is faulty.
- 18 Before moving this unit, press **ⓂMASTER ON/OFF** to release it outward to the OFF position to turn off this unit, the main room, Zone 2 and Zone 3 and then disconnect the AC power plug from the AC wall outlet.
- 19 **VOLTAGE SELECTOR** (Asia and General models only)
The **VOLTAGE SELECTOR** on the rear panel of this unit must be set for your local main voltage BEFORE plugging into the AC wall outlet. Voltages are:
.....AC 110/120/220/230–240 V, 50/60 Hz
- 20 The batteries shall not be exposed to excessive heat such as sunshine, fire or like.
- 21 Excessive sound pressure from earphones and headphones can cause hearing loss.
- 22 When replacing the batteries, be sure to use batteries of the same type. Danger of explosion may happen if batteries are incorrectly replaced.

WARNING

TO REDUCE THE RISK OF FIRE OR ELECTRIC SHOCK, DO NOT EXPOSE THIS UNIT TO RAIN OR MOISTURE.

As long as this unit is connected to the AC wall outlet, it is not disconnected from the AC power source even if you turn off this unit by **ⓂMASTER ON/OFF**. In this state, this unit is designed to consume a very small quantity of power.

FOR CANADIAN CUSTOMERS

To prevent electric shock, match wide blade of plug to wide slot and fully insert.
This Class B digital apparatus complies with Canadian ICES-003.

POUR LES CONSOMMATEURS CANADIENS

Pour éviter les chocs électriques, introduire la lame la plus large de la fiche dans la borne correspondante de la prise et pousser jusqu'au fond.
Cet appareil numérique de la classe B est conforme à la norme NMB-003 du Canada.

IMPORTANT

Please record the serial number of this unit in the space below.
MODEL:
Serial No.:
The serial number is located on the rear of the unit.
Retain this Owner's Manual in a safe place for future reference.



Manufactured under license from Dolby Laboratories. Dolby, Pro Logic and the double-D symbol are trademarks of Dolby Laboratories.



Manufactured under license under U.S. Patent No's: 5,451,942;5,956,674;5,974,380;5,978,762;6,226,616;6,487,535 & other U.S. and worldwide patents issued & pending. DTS is a registered trademark and the DTS logos, Symbol, DTS-HD and DTS-HD Master Audio are trademark of DTS, Inc. © 1996-2007 DTS, Inc. All Rights Reserved.

iPod™

“iPod” is a trademark of Apple Inc., registered in the U.S. and other countries.



Fraunhofer Institut Integrierte Schaltungen

MPEG Layer-3 audio coding technology licensed from Fraunhofer IIS and Thomson.



This receiver supports network connections.

HDMI

“HDMI”, the “HDMI” logo and “High-Definition Multimedia Interface” are trademarks, or registered trademarks of HDMI Licensing LLC.

x.v.Color™

“x.v.Color” is a trademark of Sony Corporation.

SILENT™ CINEMA

“SILENT CINEMA” is a trademark of Yamaha Corporation.



The XM name and related logos are registered trademarks of XM Satellite Radio Inc.



This product is manufactured under license from Neural Audio Corporation and THX Ltd. YAMAHA CORPORATION hereby grants the user a non-exclusive, non-transferable, limited right of use to this product under U.S.A. and foreign patent, patent pending and other technology or trademarks owned by Neural Audio Corporation and THX Ltd. “Neural Surround”, “Neural Audio”, “Neural” and “NRL” are trademarks and logos owned by Neural Audio Corporation. THX is a trademark of THX Ltd., which may be registered in some jurisdictions. All rights reserved.



©2006 SIRIUS Satellite Radio Inc. “SIRIUS”, “SiriusConnect”, the SIRIUS dog logo, channel names and logos are trademarks of SIRIUS Satellite Radio Inc.

HD Radio

HD Radio™ Technology Manufactured Under License From iBiquity Digital Corp. U.S. and Foreign Patents. HD Radio™ and the HD Radio logo are proprietary trademarks of iBiquity Digital Corp.



Rhapsody and the Rhapsody logo are registered trademarks of RealNetworks, Inc.



Circle Surround II, Dialog Clarity, TruBass, SRS and the (●) symbol are trademarks of SRS Labs, Inc. Circle Surround II, Dialog Clarity and TruBass technologies are incorporated under license from SRS Labs, Inc.

Windows XP, Windows Vista, Windows Media Audio, Windows Media Connect and Windows Media Player are either registered trademarks or trademarks of Microsoft corporation in the United States and/or other countries.

Contents

INTRODUCTION

Features	3
Supplied accessories	3
Getting started	4
Quick start guide	5

PREPARATION

Connections	9
Optimizing the speaker setting for your listening room	30

BASIC OPERATION

Playback	36
Basic procedure	36
Selecting audio input jacks (AUDIO SELECT)	37
Selecting the multi-channel input component	37
Selecting the HDMI OUT jack	37
Using your headphones	38
Muting the audio output	38
Displaying the input source information	38
Using the sleep timer	39
Sound field programs	40
Selecting sound field programs	40
Using CINEMA DSP 3D mode	46
Enjoying unprocessed input sources	46
Using audio features	47
Enjoying pure hi-fi sound	47
Adjusting the tonal quality	47
Adjusting the speaker level	47
Selecting the recording source	47
FM/AM tuning	48
Overview	48
FM/AM tuning operations	48
Preset FM/AM stations	49
Using HD Radio™ features	48
(U.S.A. model only)	51
Selecting HD Radio™ audio programs	51
Using the iTunes Tagging feature	51
Displaying HD Radio™ information	52
XM® Satellite Radio tuning	53
Connecting XM Mini-Tuner Home Dock	53
Activating XM Satellite Radio	54
XM Satellite Radio operations	54
Setting the XM Satellite Radio preset channels	55
Displaying the XM Satellite Radio information	56
SIRIUS Satellite Radio™ tuning	58
Connecting the SiriusConnect™ tuner	58
Activating SIRIUS Satellite Radio™ subscription	59
SIRIUS Satellite Radio™ operations	59
Setting the SIRIUS Satellite Radio™ preset channels	61
Setting the Parental Lock	62
Displaying the SIRIUS Satellite Radio™ information	63
Using Bluetooth™ components	64
Pairing the Bluetooth™ receiver and your Bluetooth component	64
Playback of the Bluetooth™ component	64
Music Content menu	65
Music Content menu operations	65

Using iPod™	66
iPod menu tree	66
Controlling iPod™	67
Using USB and network features	68
USB and network menu tree	68
Navigating USB and network menus	69
Using a USB storage device or a USB portable audio player	69
Using a PC server or Yamaha MCX-2000	70
Using the Internet Radio	71
Using the Rhapsody® service (U.S.A. model only)	71
Using shortcut buttons	72

ADVANCED OPERATION

Advanced sound configurations	74
Selecting decoders	74
Graphical user interface (GUI) menu	76
GUI menu overview	78
GUI menu operations	79
Saving and recalling the system settings (System Memory)	101
Controlling this unit by using the Web browser (Web Control Center)	105
Remote control features	106
Controlling this unit, a TV, or other components	106
Customizing the remote control	108
Setting the backlight mode of the remote control	109
Setting remote control codes	109
Programming codes from other remote controls	111
Changing source names in the display window	112
Macro programming features	113
Clearing configurations	115
Simplified remote control	116
Using multi-zone configuration	117
Connecting the Zone 2 and Zone 3 components	117
Controlling Zone 2 or Zone 3	119
Advanced setup	121
Using the advanced setup menu	121

ADDITIONAL INFORMATION

Troubleshooting	124
Resetting the system	138
Operation modes of front panel controls	139
Glossary	140
Sound field program information	143
Parametric equalizer information	144
Specifications	145
Index	147

APPENDIX

(at the end of this manual)

Front panel	i
Remote control	ii
Sound output in each sound field program	iii
List of remote control codes	v

INTRODUCTION

PREPARATION

BASIC OPERATION

ADVANCED OPERATION

ADDITIONAL INFORMATION

APPENDIX

English

What you can do with the GUI menu

By configuring the parameters in the GUI menu of this unit, you can adjust a variety of system settings suited for your listening environment. The following is a brief description of some of the useful menus you can configure in the GUI menu. For more detailed information, see “Graphical user interface (GUI) menu” (page 76).

Fine adjusting the speaker settings

In case speaker settings configured by automatic setup does not match your listening environment, you can configure them manually.

Setup → Speaker (page 87)

Specifying the muting type

In case you do not want to fully mute audio when you receive a call while watching your favorite TV program, you can use this menu to specify the muting level.

Setup → Volume → Muting Type (page 90)

Specifying the initial volume level

By adjusting this parameter, you can automatically control the initial volume level regardless of the recording level of the audio source.

Setup → Volume → Initial Volume (page 90)

Adjusting the dynamic range

The dynamic range is the difference between the minimum and maximum amplitude. The higher the dynamic range, the more accurate the sound reproduction for bitstream signals. You can adjust the dynamic range for speakers and headphones individually. Also, you can use the adaptive dynamic range control feature to adjust the dynamic range automatically in conjunction with the volume level.

Setup → Sound → Dynamic Range (page 90)

Setup → Volume → Adaptive DRC (page 89)

Adjusting the audio and video synchronization

Sometimes, depending on your video source component, video is delayed relative to audio due to processing problems. In this case, you need to manually adjust the audio delay to keep it synchronized with the video. If you connect the video source component to this unit using an HDMI connection and your component supports the LIPSYNC feature, you can adjust the audio/video synchronization automatically.

Setup → Sound → Lipsync (page 92)

Changing input/output assignment

In case the initial input/output assignments do not correspond to your needs, you can rearrange them according to your component to be connected to this unit. You can also edit the input name to be displayed in the front panel or in the GUI screen as necessary.

Setup → Option → I/O Assignment (page 98)

Setup → Option → Input Rename (page 98)

Fixing the volume difference between input sources

The sound output level may vary depending on the audio source components connected to this unit. In this case, you can reduce or increase the output level of each input source using this feature.

Input Select → (input source) → (submenu) → Volume Trim (page 85)

Setting the background video for discrete multi-channel input

If you want to enjoy video images in combination with discrete multi-channel audio input, configure this setting to specify the video input source. For example, to view DVD video images while listening to the music sources from a multi-format player or an external decoder, set this setting to “DVD”.

Input Select → MULTI CH → (submenu) → BGV (page 86)

Adjusting the brightness of the front panel display

You can make the front panel display darker or brighter by configuring this setting.

Setup → Option → Display Set → Front Panel Display → Dimmer (page 98)

Turning on or off the short message display

Each time you operate this unit using controls on the front panel or remote control keys, this unit displays short messages on the video monitor. If you want to turn off the short message display, select “Off” in this setting (Initial factory setting is “On”).

Setup → Option → Display Set → Short Message (page 98)

Setting the amount of time to display GUI screen information

You can set the amount of time to display playback information in the GUI screen after you perform a certain operation.

Setup → Option → Display Set → Playback Screen (page 98)

Protecting the setup values

After you have configured the sound field program parameters and other system settings, you can use this feature to prevent accidental changes to those setup values.

Setup → Option → Memory Guard (page 97)

Features

Built-in 7-channel power amplifier

- ◆ Minimum RMS output power (20 Hz to 20 kHz, 0.04% THD, 8 Ω)
Front: 140 W + 140 W
Center: 140 W
Surround: 140 W + 140 W
Surround back: 140 W + 140 W

Various input/output connectors

- ◆ HDMI (IN x 4, OUT x 2), Component video (IN x 3, OUT x 1), S-video (IN x 6, OUT x 3), Composite video (IN x 6, OUT x 5), Coaxial digital audio (IN x 3), Optical digital audio (IN x 5, OUT x 2), Analog audio (IN x 10, OUT x 3)
- ◆ Speaker out (7-channel), Pre out (7-channel), Subwoofer out, Presence out, Zone 2/Zone 3 out
- ◆ Discrete multi-channel input (6 or 8-channel)

Sound field programs

- ◆ Proprietary Yamaha technology for the creation of sound fields
- ◆ CINEMA DSP 3D
- ◆ Compressed Music Enhancer mode
- ◆ Virtual CINEMA DSP
- ◆ SILENT CINEMA

Digital audio decoders

- ◆ Dolby TrueHD, Dolby Digital Plus decoder
- ◆ DTS-HD Master Audio, DTS-HD High Resolution Audio decoder
- ◆ Dolby Digital/Dolby Digital EX decoder
- ◆ DTS/DTS-ES Matrix 6.1, Discrete 6.1, DTS 96/24 decoder
- ◆ Dolby Pro Logic/Dolby Pro Logic II/Dolby Pro Logic IIX decoder
- ◆ DTS NEO:6 decoder
- ◆ Neural-THX Surround decoder (U.S.A. and Canada models only)
- ◆ SRS Circle Surround II decoder (U.S.A. model only)

Radio tuners

- ◆ FM/AM tuning capability, 40-station preset tuning
- ◆ HD Radio™ digital broadcast reception capability (U.S.A. model only)
- ◆ XM Satellite Radio tuning capability (using XM Mini-Tuner and Home Dock, sold separately)
- ◆ SIRIUS Satellite Radio™ tuning capability (using SiriusConnect tuner, sold separately)

HDMI™ (High-Definition Multimedia Interface)

- ◆ HDMI interface for standard, enhanced or high-definition video as well as multi-channel digital audio based on HDMI version 1.3a (HDMI is licensed by HDMI Licensing, LLC.)
 - Automatic audio and video synchronization (lip sync) information capability
 - Deep Color video signal (30/36 bit) transmission capability

- “x.v.Color” video signal transmission capability
- High refresh rate and high resolution video signals capability
- High definition digital audio format signals capability
- ◆ HDCP (High-bandwidth Digital Content Protection System) licensed by Digital Content Protection, LLC.
- ◆ Analog video to HDMI digital video up-conversion (composite video ↔ S-video ↔ component video → HDMI digital video) capability for monitor out
- ◆ Analog and HDMI video up-scaling: 480i(576i) → 480p(576p)/720p/1080i/1080p, 480p(576p) → 720p/1080i/1080p, 720p → 1080i/1080p, 1080i → 720p/1080p

DOCK terminal

- ◆ DOCK terminal to connect a Yamaha iPod universal dock (such as YDS-11, sold separately) or Bluetooth wireless audio receiver (such as YBA-10, sold separately)

USB and network features

- ◆ USB port to connect a USB storage device, USB Hard disc drive, or USB portable audio player
- ◆ NETWORK port to connect a PC and Yamaha MCX-2000 or access the Internet Radio and Rhapsody® (U.S.A. model only) via LAN
- ◆ DHCP automatic or manual network configuration
- ◆ Web control capability of this unit by using a Web browser

Automatic speaker setup features

- ◆ Advanced YPAO (Yamaha Parametric room Acoustic Optimizer) for automatic speaker setup
- ◆ Multi-point measurement feature for multiple listening positions
- ◆ Parametric equalizer select feature

Other features

- ◆ 192-kHz/24-bit D/A converter
- ◆ GUI (graphic user interface) menus that allow you to optimize this unit to suit your individual audiovisual system
- ◆ Music Content menu that allows you to easily navigate music content menus of your iPod, USB component, Internet Radio, etc.
- ◆ PURE DIRECT mode for pure hi-fi sound for all sources
- ◆ Adaptive dynamic range controlling capability
- ◆ Adaptive DSP effect level controlling capability
- ◆ Remote control with preset remote control codes, learning and macro capability
- ◆ ZONE 2/ZONE 3 custom installation facility
- ◆ Zone switching capability between the main zone and ZONE 2/ZONE 3 using ZONE CONTROLS
- ◆ System Memory capability for saving and recalling multiple system parameter settings
- ◆ Sleep timer for each zone



Supplied accessories

Check that you received all of the following parts.

- Remote control
- Simplified remote control
- Batteries (4) (AAA, LR03, UM-4)
- Power cable (Two for Asia model)
- Optimizer microphone
- AM loop antenna
- Indoor FM antenna

Getting started

About this manual

-  indicates a tip for your operation.
- Some operations can be performed by using either the buttons on the front panel or the ones on the remote control. In case the button names differ between the front panel and the remote control, the button name on the remote control is given in parentheses.
- This manual is printed prior to production. Design and specifications are subject to change in part as a result of improvements, etc. In case of differences between the manual and product, the product has priority.
- “ MASTER ON/OFF” or “ DVD” (example) indicates the name of the parts on the front panel or the remote control. Refer to the attached sheet or the pages at the end of this manual for the information about each position of the parts.

■ Installing batteries in the remote control

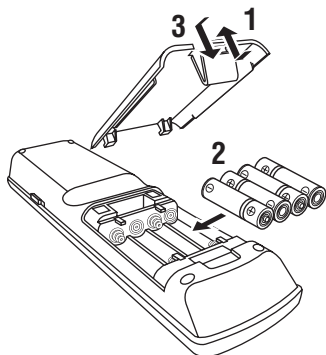

- 1 Take off the battery compartment cover.**
- 2 Insert the four supplied batteries (AAA, LR03, UM-4) according to the polarity markings (+ and -) on the inside of the battery compartment.**
- 3 Snap the battery compartment cover back into place.**

Notes

- Change all of the batteries if you notice the following conditions:
 - the operation range of the remote control decreases.
 - the transmit indicator does not flash or its light becomes dim.
- Do not use old batteries together with new ones.
- Do not use different types of batteries (such as alkaline and manganese batteries) together. Read the packaging carefully as these different types of batteries may have the same shape and color.
- If the batteries have leaked, dispose of them immediately. Avoid touching the leaked material or letting it come into contact with clothing, etc. Clean the battery compartment thoroughly before installing new batteries.
- Do not throw away batteries with general house waste; dispose of them correctly in accordance with your local regulations.
- If the remote control is without batteries for more than 2 minutes, or if exhausted batteries remain in the remote control, the contents of the memory may be cleared. When the memory is cleared, insert new batteries, set up the remote control code and program any acquired functions that may have been cleared.

■ VOLTAGE SELECTOR (Asia and General models only)

Caution

The VOLTAGE SELECTOR on the rear panel of this unit must be set for your local voltage BEFORE plugging the power cable into the AC wall outlet. Improper setting of the VOLTAGE SELECTOR may cause damage to this unit and create a potential fire hazard.

Rotate the VOLTAGE SELECTOR clockwise or counterclockwise to the correct position using a straight slot screwdriver.

Voltages are as follows:

.....AC 110/120/220/230-240 V, 50/60 Hz

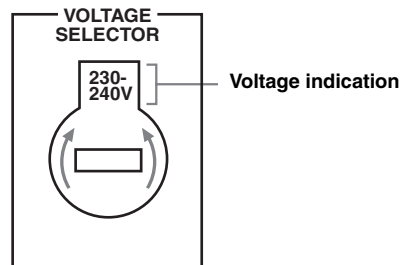

Quick start guide

The following steps describe the easiest way to enjoy DVD movie playback in your home theater.

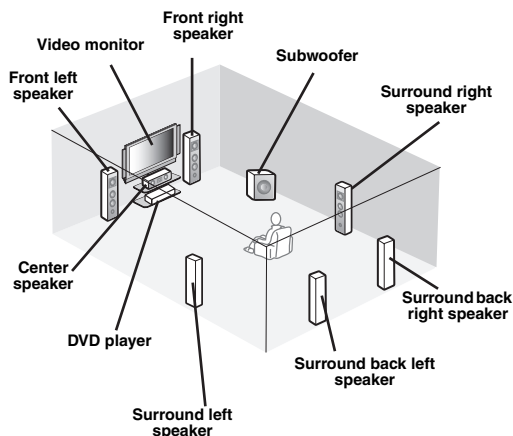

Step 1: Set up your speakers

P. 6

Step 2: Connect your DVD player and other components

P. 7

Step 3: Turn on the power and start playback

P. 8

Enjoy DVD playback!

Preparation: Check the items

In these steps, you need the following supplied accessories.

- Power cable**

The following items are not included in the package of this unit.

- Speakers**
 - Front speaker** x 2
 - Center speaker** x 1
 - Surround speaker** x 4

Select magnetically shielded speakers. The minimum required speakers are two front speakers. The priority of the requirement of other speakers is as follows:

1. Two surround speakers
2. One center speaker
3. One (or two) surround back speaker(s)

- Active subwoofer** x 1
Select an active subwoofer equipped with an RCA input jack.
- Speaker cable** x 7
- Subwoofer cable** x 1
Select a monaural RCA cable.
- DVD player** x 1
Select DVD player equipped with coaxial digital audio output jack and composite video output jack.
- Video monitor** x 1
Select a TV monitor, video monitor or projector equipped with a composite video input jack.
- Video cable** x 2
Select RCA composite video cables.
- Digital coaxial audio cable** x 1

Step 1: Set up your speakers

Place your speakers in the room and connect them to this unit.

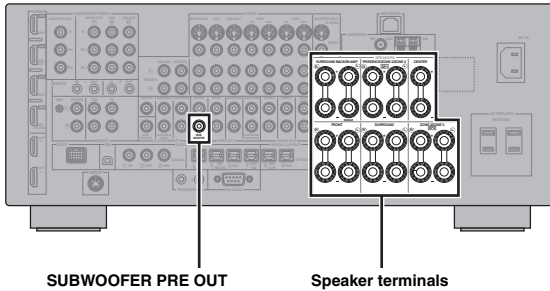

1 Place your speakers and subwoofer in the room.

2 Connect speaker cables to each speaker.

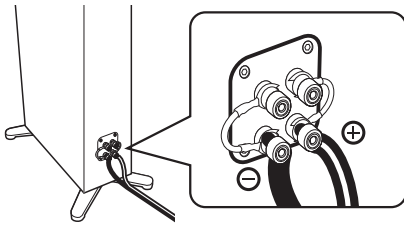

3 Connect each speaker cable to the corresponding speaker terminal of this unit.

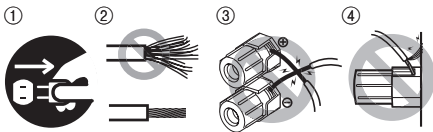

- 1 Make sure that this unit and the subwoofer are unplugged from the AC wall outlets.
- 2 Twist the exposed wires of the speaker cables together to prevent short circuits.
- 3 Do not let the bare speaker wires touch each other.
- 4 Do not let the bare speaker wires touch any metal part of this unit.

Be sure to connect the left channel (L), right channel (R), “+” (red) and “-” (black) properly.

Front speakers and center speaker

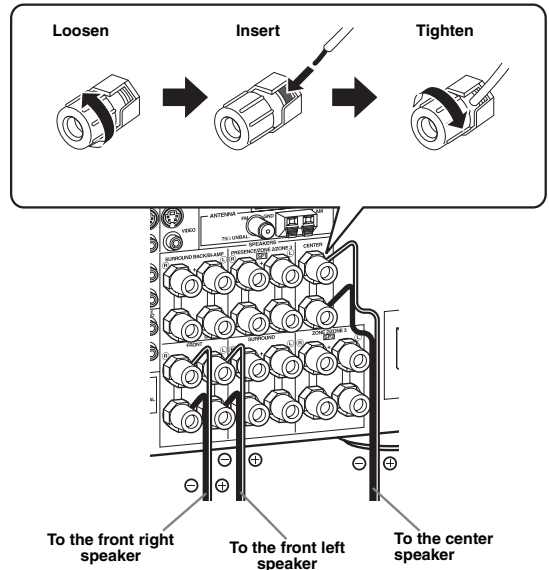

Surround and surround back speakers

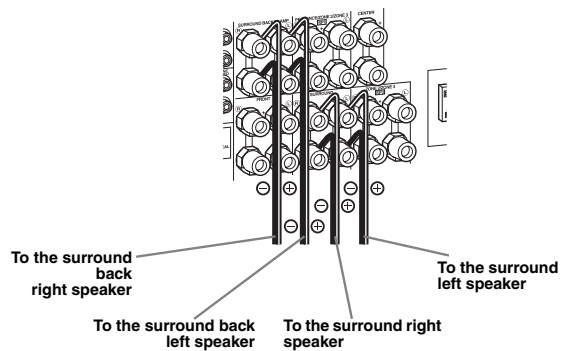

4 Connect the subwoofer cable to the SUBWOOFER PRE OUT jack of this unit and the input jack of the subwoofer.

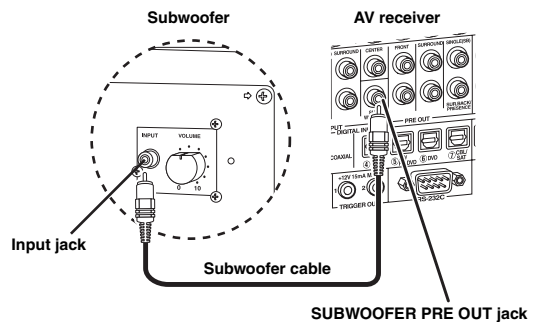

Step 2: Connect your DVD player and other components

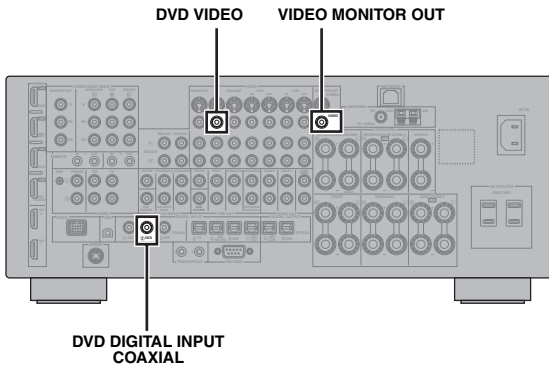

Make sure that this unit and the DVD player are unplugged from the AC wall outlets.

- 1 Connect the digital coaxial audio cable to the digital coaxial audio output jack of your DVD player and the DVD DIGITAL INPUT COAXIAL jack of this unit.

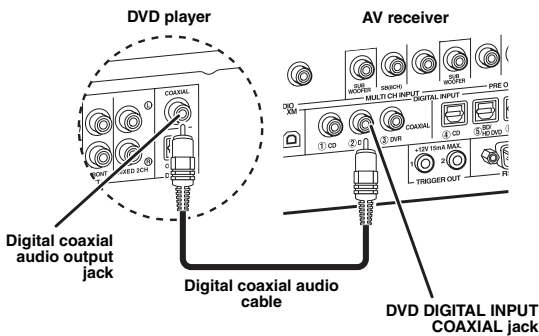

- 2 Connect the video cable to the composite video output jack of your DVD player and DVD VIDEO jack of this unit.

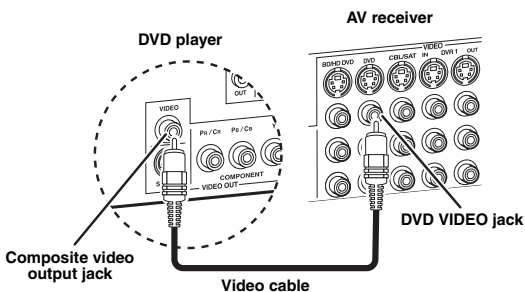

- 3 Connect the video cable to the VIDEO MONITOR OUT jack of this unit and the video input jack of your video monitor.

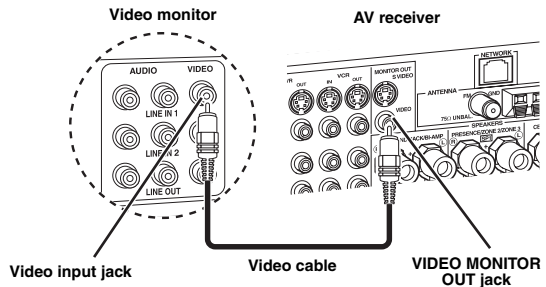

- 4 Connect the supplied power cable to this unit and then plug of the power cable and other components into the AC wall outlet.



For details about connecting the power cable, see page 25.

■ For other connections

- Other speaker combinations P. 12
- Information on jacks and cable plugs P. 15
- Information on HDMI™ P. 16
- TV monitor or projector P. 18
- Other components P. 19
- External amplifier P. 21
- Multi-format player or external decoder P. 22
- Yamaha iPod universal dock or Bluetooth wireless audio receiver P. 22
- FM/AM antennas P. 24
- XM Mini-Tuner Home Dock P. 53
- SiriusConnect tuner P. 58
- Network P. 23
- USB device P. 23

Step 3: Turn on the power and start playback

Check the type of the connected speakers.

If the speakers are 6-ohm speakers, set "SPEAKER IMP:" to "6Ω MIN" before using this unit (page 26). You can also use 4-ohm speakers as the front speakers (page 121).

1 Turn on the video monitor connected to this unit.

2 Press **A** **MASTER ON/OFF** inward to the ON position on the front panel.

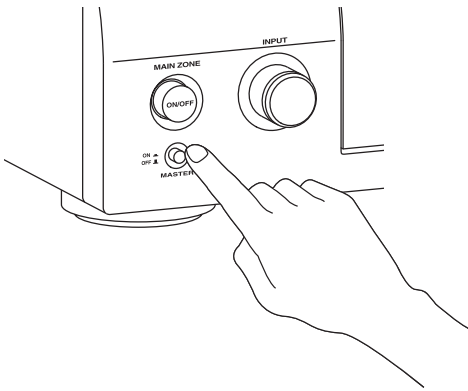

3 Rotate the **C** **INPUT** selector to set the input source to "DVD".

4 Start playback of the desired DVD on your player.

5 Rotate **P** **VOLUME** to adjust the volume.

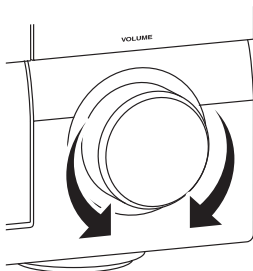

6 To set this unit to the standby mode, press **B** **MAIN ZONE ON/OFF**.

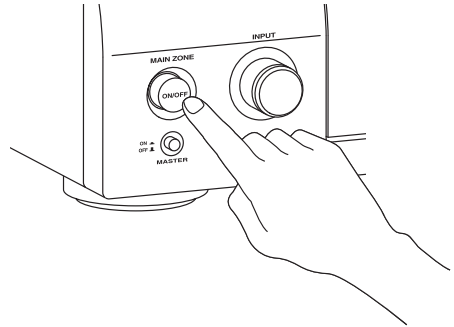

For details about turning on/off this unit and the standby mode, see page 26.

■ For other operations

- Optimizing the speaker parameters automatically P. 30
- Basic playback operations P. 36
- Sound field programs P. 40
- Pure high-fidelity sounds P. 47
- FM/AM radio tuning P. 48
- XM Satellite Radio tuning P. 53
- SIRIUS Satellite Radio tuning P. 58
- Bluetooth component playback P. 64
- iPod playback P. 66
- Playback via USB or network P. 68

Connections

Rear panel

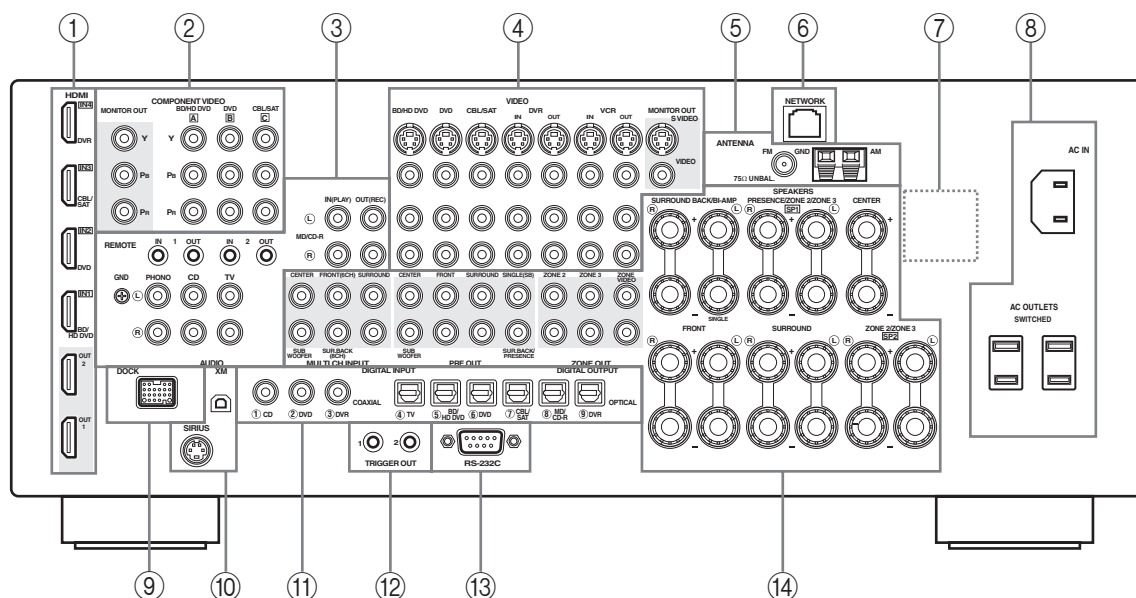

Name	Page
① HDMI jacks	16
② COMPONENT VIDEO jacks	15
③ Audio component jacks	15
REMOTE IN/OUT jacks	22, 117
④ Video component jacks	15
⑤ ANTENNA terminals	24
⑥ NETWORK port	23
⑦ VOLTAGE SELECTOR (Asia and General models only)	25
⑧ AC IN	25
AC OUTLET(S)	25
⑨ DOCK terminal	22
⑩ XM jack (U.S.A. and Canada models only)	53
SIRIUS jack (U.S.A. and Canada models only)	58
⑪ DIGITAL INPUT/OUTPUT jacks	15
⑫ TRIGGER OUT jacks	119
⑬ RS-232C terminal	—

Name	Page
⑭ MULTI CH INPUT jacks	22
PRE OUT jacks	21
ZONE OUT jacks	117
Speaker terminals	12

Note

The RS-232C terminal is a control expansion terminal for factory use only. Consult your dealer for details.

Placing speakers

The speaker layout below shows the speaker setting we recommend.



- 7.1-channel speaker layout is highly recommended for playback of the high definition digital audio sources (Dolby TrueHD, DTS-HD Master Audio, etc.) with sound field programs.
- We recommend that you add the presence speakers for the effect sounds of the CINEMA DSP sound field program.

7.1-channel speaker layout

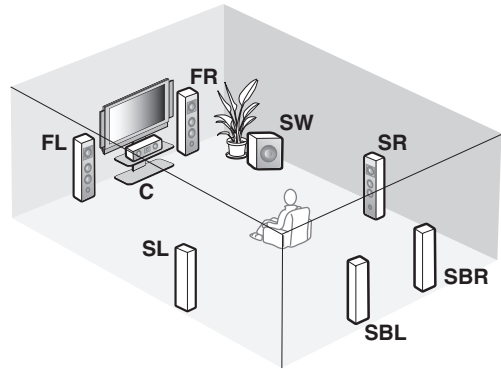
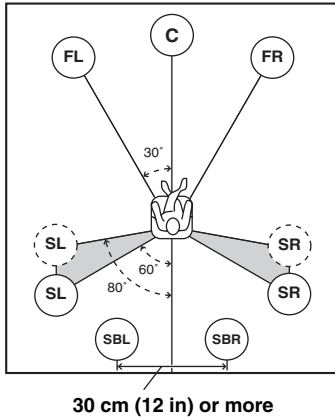

6.1-channel speaker layout

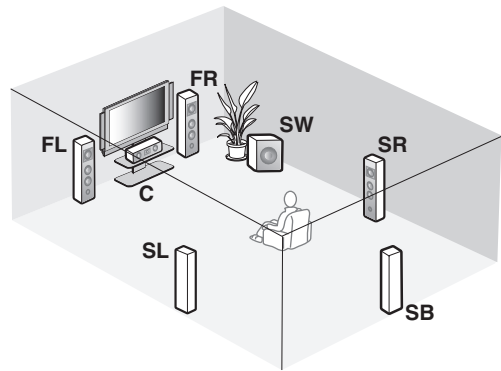
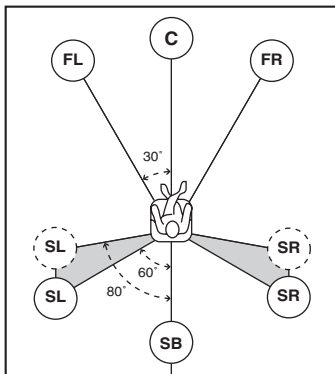

5.1-channel speaker layout

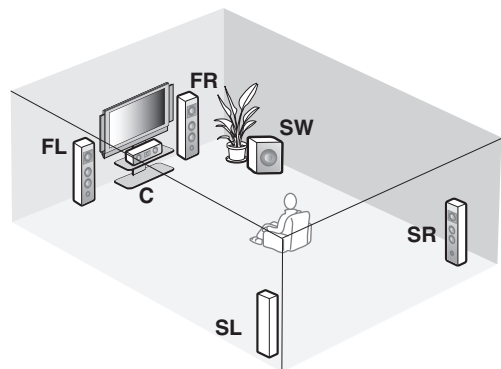
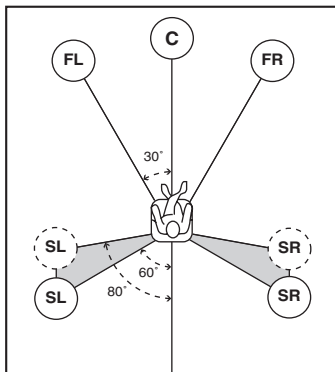

■ Speaker types

Front left and right speakers (FL and FR)

The front speakers are used for the main source sound plus effect sounds. Place these speakers at an equal distance from the ideal listening position. The distance of each speaker from each side of the video monitor should be the same.

Center speaker (C)

The center speaker is for the center channel sounds (dialog, vocals, etc.). If for some reason it is not practical to use a center speaker, you can do without it. Best results, however, are obtained with the full system.

Surround left and right speakers (SL and SR)

The surround speakers are used for effect and surround sounds.

For 5.1-channel speaker layout, place these speakers farther back compared with the placement in the 7.1-channel speaker layout.

Surround back left and right speakers (SBL and SBR) /Surround back speaker (SB)

The surround back speakers supplement the surround speakers and provide more realistic front-to-back transitions.

For 6.1-channel speaker layout, surround back left and right channel signals are mixed down and output at the single surround back speaker by configuring the “Surround Back” setting (page 88).

For 5.1-channel speaker layout, surround back left and right channel signals are output at the surround left and right speakers by configuring the “Surround Back” setting (page 88).

Subwoofer (SW)

The use of a subwoofer with a built-in amplifier, such as the Yamaha Active Servo Processing Subwoofer System, is effective not only for reinforcing bass frequencies from any or all channels, but also for reproducing the high fidelity sound of the LFE (low-frequency effect) channel included in bitstreams and multi-channel PCM sources.

The position of the subwoofer is not so critical, because low bass sounds are not highly directional. But it is better to place the subwoofer near the front speakers. Turn it slightly toward the center of the room to reduce wall reflections.

For other speaker combinations

You can enjoy multi-channel sources with sound field programs by using a speaker combination other than the 7.1/6.1/5.1-channel speaker combinations.

Use the automatic setup feature (page 30) or set the “Speaker” parameters (page 87). to output the surround sounds at the connected speakers.

■ Presence left and right speakers (PL and PR)

The presence speakers supplement the sound from the front speakers with extra ambient effects produced by the sound field programs (page 40). We recommend that you use the presence speakers especially for the CINEMA DSP sound field programs. To use the presence speakers, connect the speakers to SP1 speaker terminals and then set “Front Presence” to “Yes” (page 88).

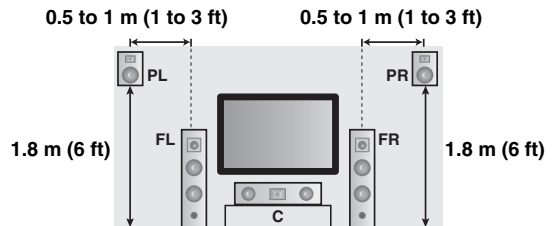

Connecting speakers

Be sure to connect the left channel (L), right channel (R), “+” (red) and “-” (black) properly. If the connections are faulty, this unit cannot reproduce the input sources accurately.

Caution

- Before connecting the speakers, make sure that this unit is turned off (page 26).
- Do not let the bare speaker wires touch each other or do not let them touch any metal part of this unit. This could damage this unit and/or speakers.
- Use magnetically shielded speakers. If this type of speaker still creates interference with the monitor, place the speakers away from the monitor.
- If you are to use 6-ohm speakers, be sure to set “SPEAKER IMP.” to “6Ω MIN” before using this unit (page 26). You can also use 4-ohm speakers as the front speakers (page 121).

Notes

- A speaker cord is actually a pair of insulated cables running side by side. Cables are colored or shaped differently, perhaps with a stripe, groove or ridge. Connect the striped (grooved, etc.) cable to the “+” (red) terminals of this unit and your speaker. Connect the plain cable to the “-” (black) terminals.
- You can connect both surround back and presence speakers to this unit, however they do not output sound simultaneously. This unit automatically switches the presence speakers and surround back speakers depending on the input sources and the selected sound field programs.

■ 7.1-channel speaker connection

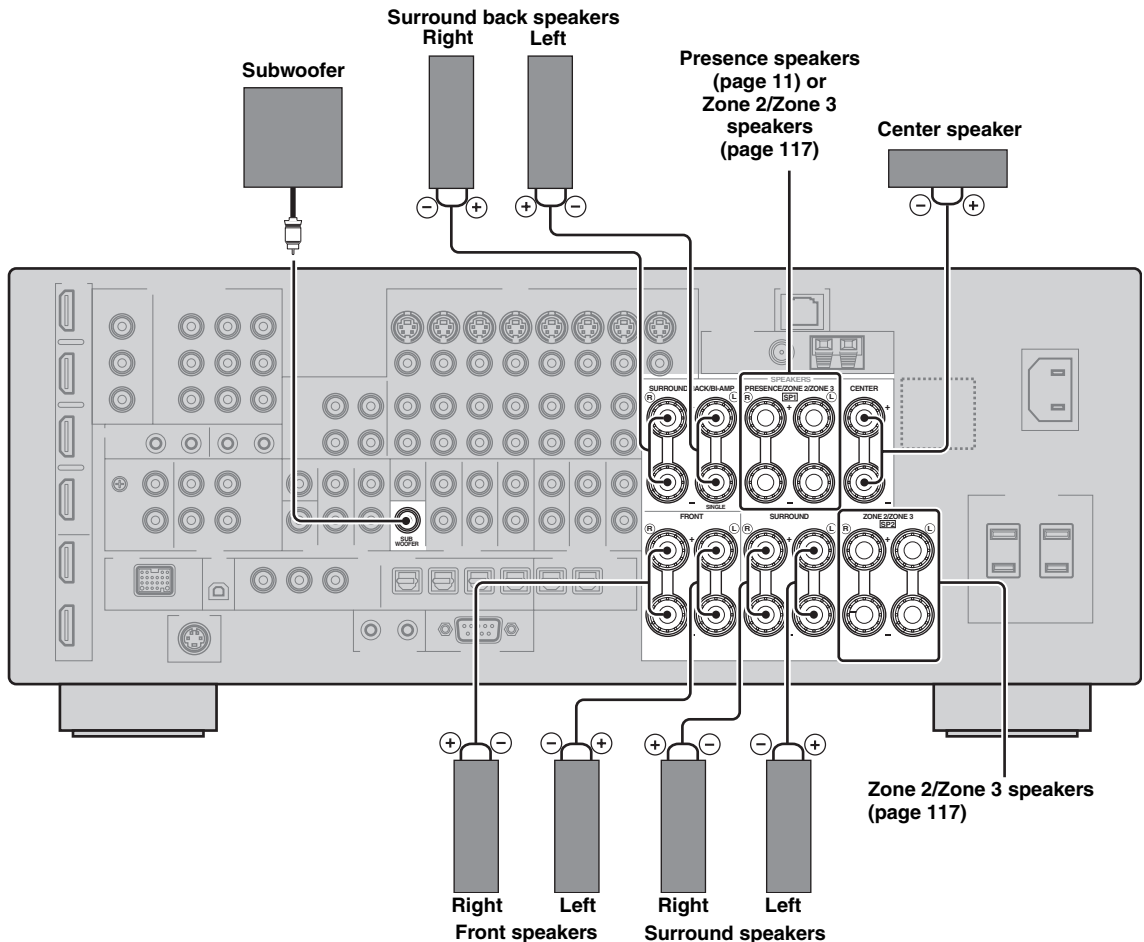

■ 6.1-channel speaker connection

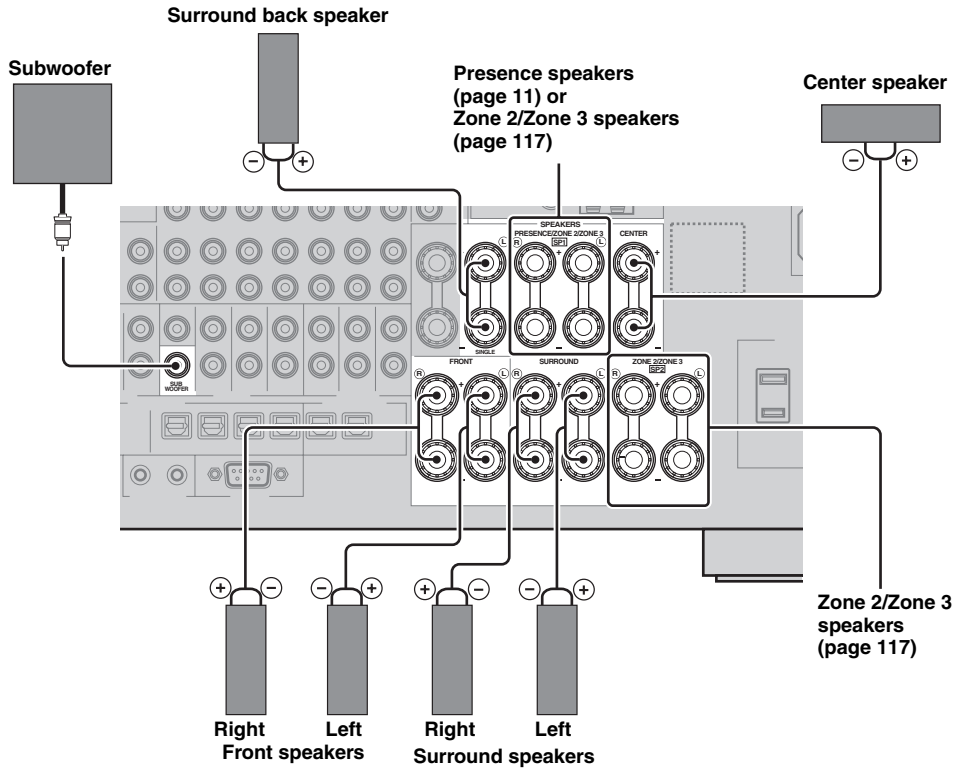

■ 5.1-channel speaker connection

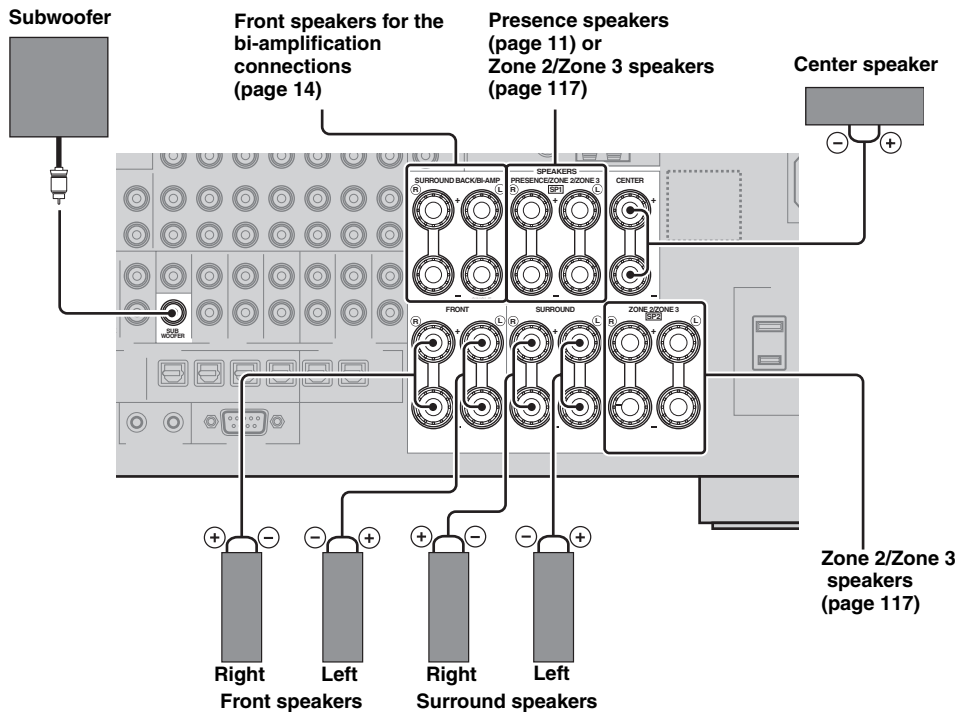

■ Connecting the speaker cable

- 1 Remove approximately 10 mm (0.4 in) of insulation from the end of each speaker cable and then twist the exposed wires of the cable together to prevent short circuits.

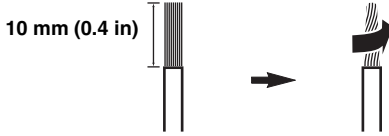

- 2 Loosen the knob, insert one bare wire into the hole and then tighten the knob.

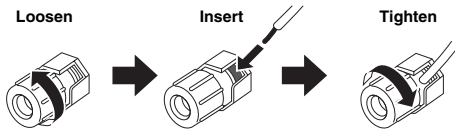

■ Connecting the banana plug (Except U.K., Europe, Asia and Korea models)

Tighten the knob and then insert the banana plug into the end of the terminal.

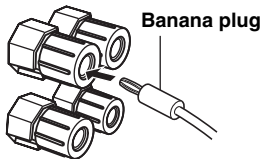

■ Using bi-amplification connections

Caution

Remove the shorting bars or bridges of your speakers to separate the LPF (low pass filter) and HPF (high pass filter) crossovers.

You can make bi-amplification connections to one speaker system which supports bi-amplification connection as shown below. To activate the connections, configure the "BI-AMP" setting (page 122).

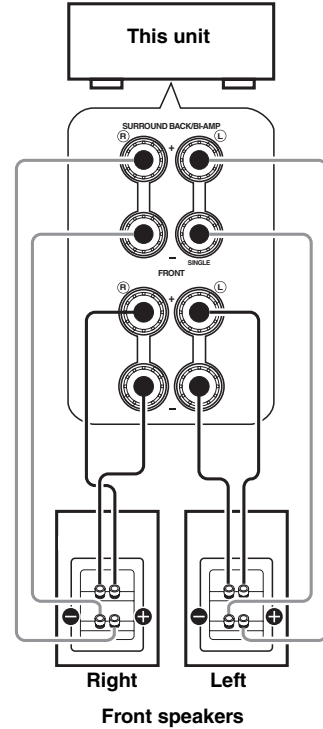

Note

When you make the conventional connection with the speakers, make sure that the shorting bars are put into the terminals of the speakers appropriately. Refer to the instruction manuals of the speakers for details.

Information on jacks and cable plugs

This unit has three types of audio jacks, three types of video jacks and HDMI jacks. You can choose the connection method depending on the component to be connected.

■ Audio jacks

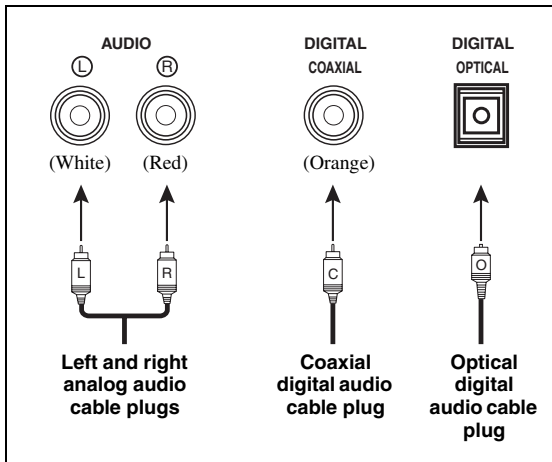

AUDIO jacks

For conventional analog audio signals transmitted via left and right analog audio cables. Connect red plugs to the right jacks and white plugs to the left jacks.

COAXIAL jacks

For digital audio signals transmitted via coaxial digital audio cables.

OPTICAL jacks

For digital audio signals transmitted via optical digital audio cables.

Note

You can use the digital jacks to input PCM, Dolby Digital and DTS bitstreams. When you connect components to both the COAXIAL and OPTICAL jacks, priority is given to the signals input at the COAXIAL jack. All digital input jacks are compatible with up to 96-kHz sampling digital signals.

■ Video jacks

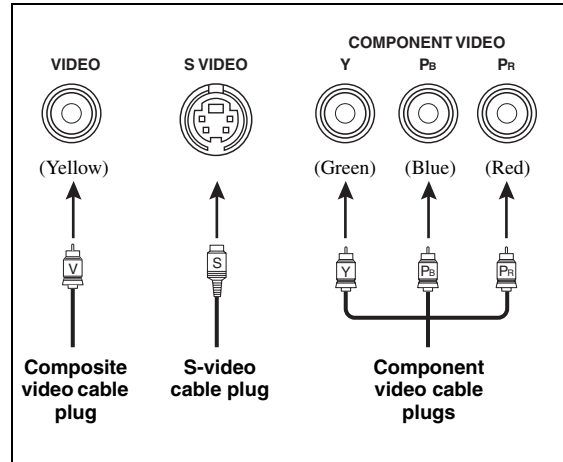

VIDEO jacks

For conventional composite video signals transmitted via composite video cables.

S VIDEO jacks

For S-video signals, separated into the luminance (Y) and chrominance (C) video signals transmitted on separate wires of S-video cables.

COMPONENT VIDEO jacks

For component video signals, separated into the luminance (Y) and chrominance (P_B, P_R) video signals transmitted on separate wires of component video cables.



This unit is equipped with the video conversion function. (page 17)

Information on HDMI™

This unit has four HDMI input jacks and two HDMI output jacks for digital audio and video signal input/output.

■ HDMI jack and cable plug

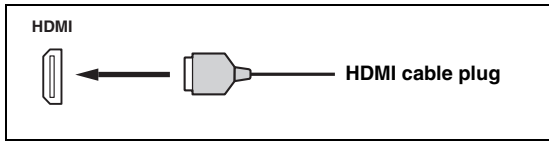

- We recommend that you use a commercially available HDMI cable shorter than 5 meters (16 feet) with the HDMI logo printed on it.
- Use a conversion cable (HDMI jack ↔ DVI-D jack) to connect this unit to other DVI components.
- You can check the potential problem about the HDMI connection (page 38).
- If you set “Mode” in “Standby Through” to “Last” or “Fix”, this unit allows the HDMI signals input at an HDMI IN jack to pass through this unit and output at an HDMI OUT jack (page 94).
- This unit is equipped with two HDMI OUT jacks. You can select the active HDMI OUT jack(s) (page 37).
- This unit is equipped with the video conversion function (page 17).

Notes

- Do not disconnect or connect the cable or turn off the power of the HDMI components connected to the HDMI OUT jacks of this unit while data is being transferred. Doing so may disrupt playback or cause noise.
- The HDMI OUT jacks output the audio signals input at the HDMI input jacks only.
- If you turn off the video monitor connected to the HDMI OUT jacks via a DVI connection, the connection may fail.

■ HDMI signal compatibility with this unit

Audio signals

Audio signal types	Audio signal formats	Compatible media
2ch Linear PCM	2ch, 32-192 kHz, 16/20/24 bit	CD, DVD-Video, DVD-Audio, etc.
Multi-ch Linear PCM	8ch, 32-192 kHz, 16/20/24 bit	DVD-Audio, etc.
DSD	2/5.1ch, 2.8224 MHz, 1 bit	SA-CD, etc.
Bitstream	Dolby Digital, DTS	DVD-Video, etc.
Bitstream (High definition audio)	Dolby TrueHD, Dolby Digital Plus, DTS-HD Master Audio, DTS-HD High Resolution Audio	Blu-ray Disc, HD DVD, etc.



- If the input source component can decode the bitstream audio signals of audio commentaries, you can play back the audio sources with the audio commentaries mixed down by using the following

connections:

- multi-channel analog audio input (page 22)
- DIGITAL INPUT OPTICAL (or COAXIAL)
- Refer to the instruction manuals of the input source component, and set the component appropriately.

Notes

- When CPPM copy-protected DVD audio is played back, video and audio signals may not be output depending on the type of the DVD player.
- This unit is not compatible with HDCP-incompatible HDMI or DVI components.
- To decode the audio bitstream signals on this unit, set the input source component appropriately so that the component outputs the audio bitstream signals directly (does not decode the bitstream signals on the component).
- This unit is not compatible with the audio commentary features (for example, the special audio contents downloaded via Internet) of Blu-ray Disc or HD DVD. This unit does not play back the audio commentaries of the Blu-ray Disc or HD DVD contents.

Video signals

This unit is compatible with the video signals of the following resolutions:

- 480i/60 Hz
- 576i/50 Hz
- 480p/60 Hz
- 576p/50 Hz
- 720p/60 Hz, 50 Hz
- 1080i/60 Hz, 50 Hz
- 1080p/60 Hz, 50 Hz, 24Hz

Compatibility with Deep Color and x.v.Color video signals

This unit accepts Deep Color (30 or 36-bit) and x.v.Color video signals. To output those video signals from the HDMI OUT jacks without any processing, set “HDMI ▶ HDMI” (page 94)” to “Through”.

Note

If the video monitor is not compatible with Deep Color or x.v.Color video signals, the video source may not be played back correctly.

■ Default input assignment of HDMI input jacks

HDMI input jack	Assigned input source
IN1	BD/HD DVD
IN2	DVD
IN3	CBL/SAT
IN4	DVR

Audio and video signal flow

Audio signal flow

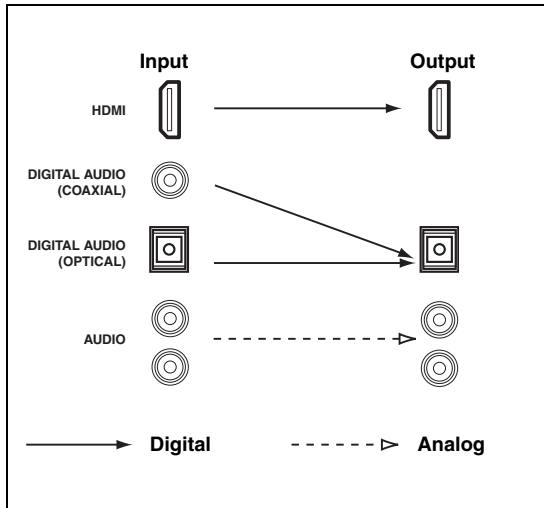

Note

Only the HDMI input jacks support DSD, Dolby TrueHD, Dolby Digital Plus, DTS-HD Master Audio and DTS-HD High Resolution Audio signal inputs.

Video signal flow

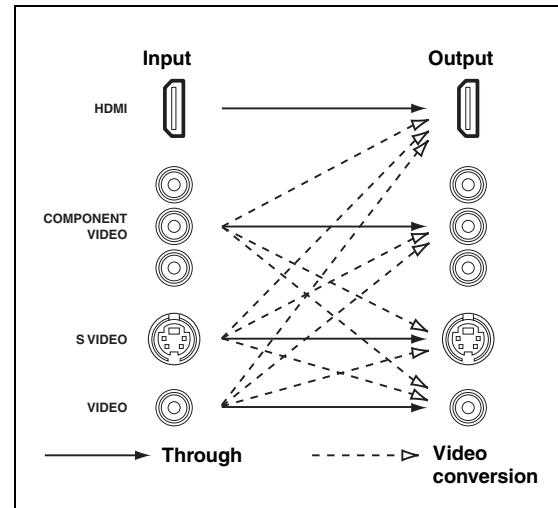

- Analog-to-HDMI video conversion is always possible unless video signals are being input at the HDMI input jacks or 1080p-resolution analog video signals are being input.
- To set the analog-to-analog video conversion or change the other video settings, configure the "Video" parameters (page 93).
- If different analog video signals are input concurrently, the following priority order will be applied:
(1) COMPONENT VIDEO, (2) S VIDEO, (3) VIDEO

Connecting a TV monitor or projector



Make sure that this unit and other components are unplugged from the AC wall outlets.



To select the types of the audio signals output at the HDMI OUT jacks, configure the "Audio Output" setting (page 95).

Note

If you turn off the video monitor connected to the HDMI OUT jacks via a DVI connection, the connection may fail. In this case, the HDMI indicator flashes irregularly.

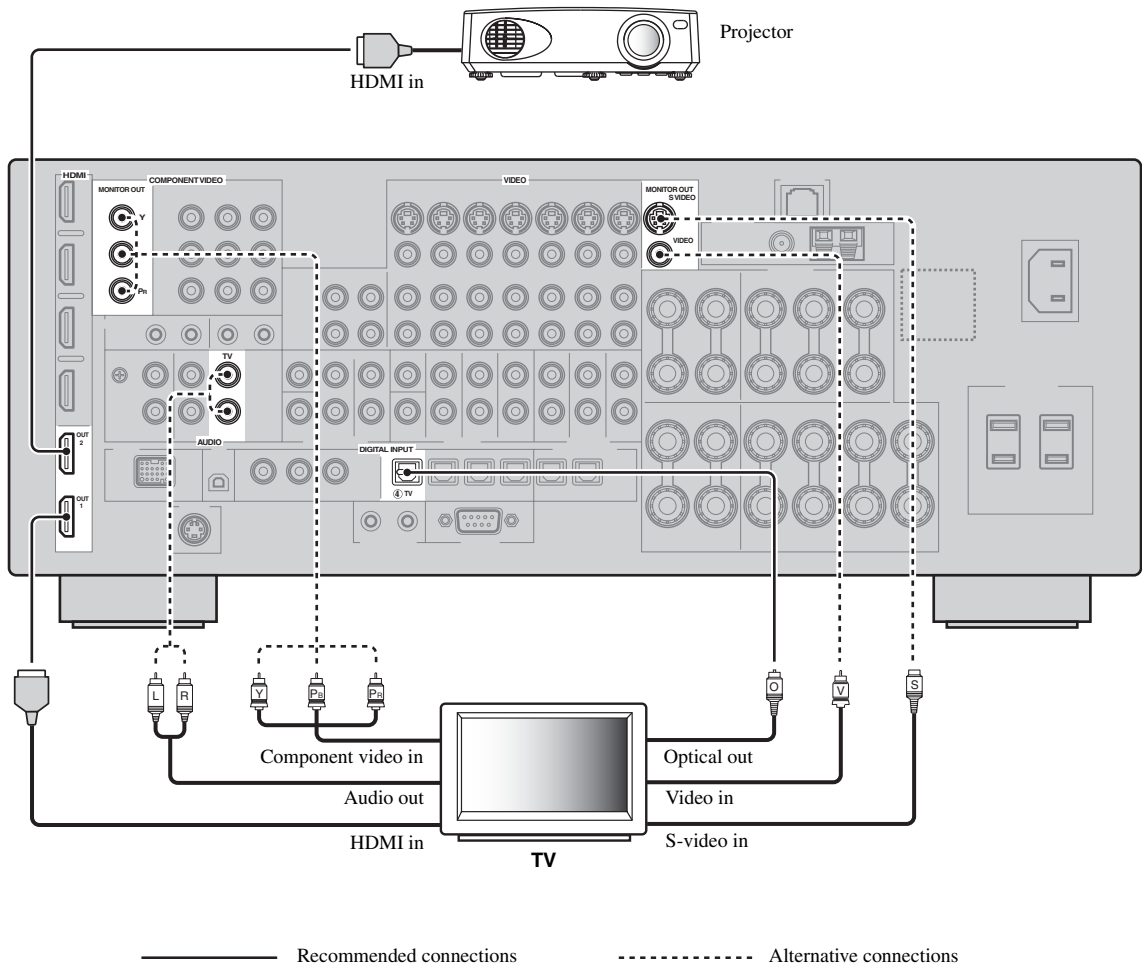

Connecting other components

■ Connecting audio and video components

This unit has three types of audio jacks, three types of video jacks and HDMI jacks. You can choose the connection method depending on the component to be connected.



HDMI can transmit both digital audio and video over a single HDMI cable.

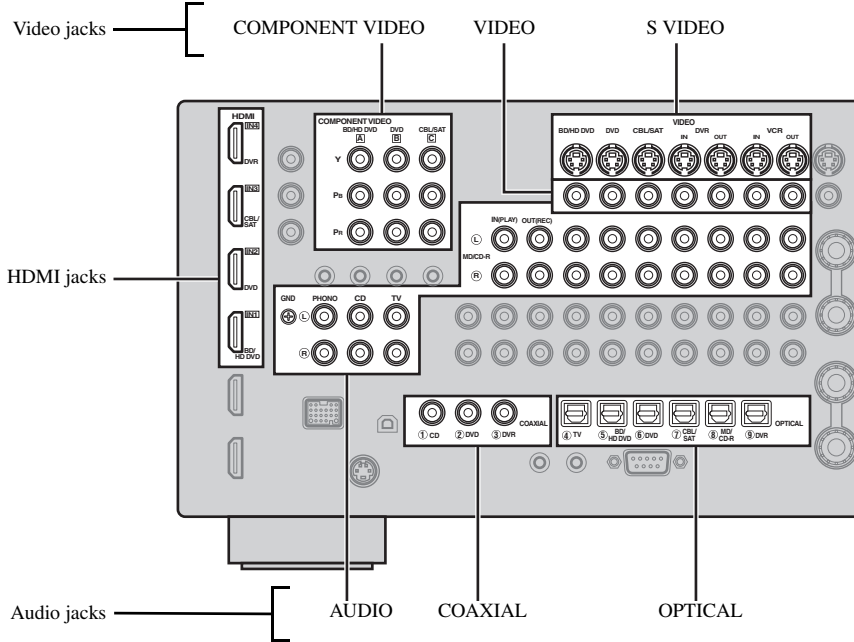

Connection example (connecting a DVD player)

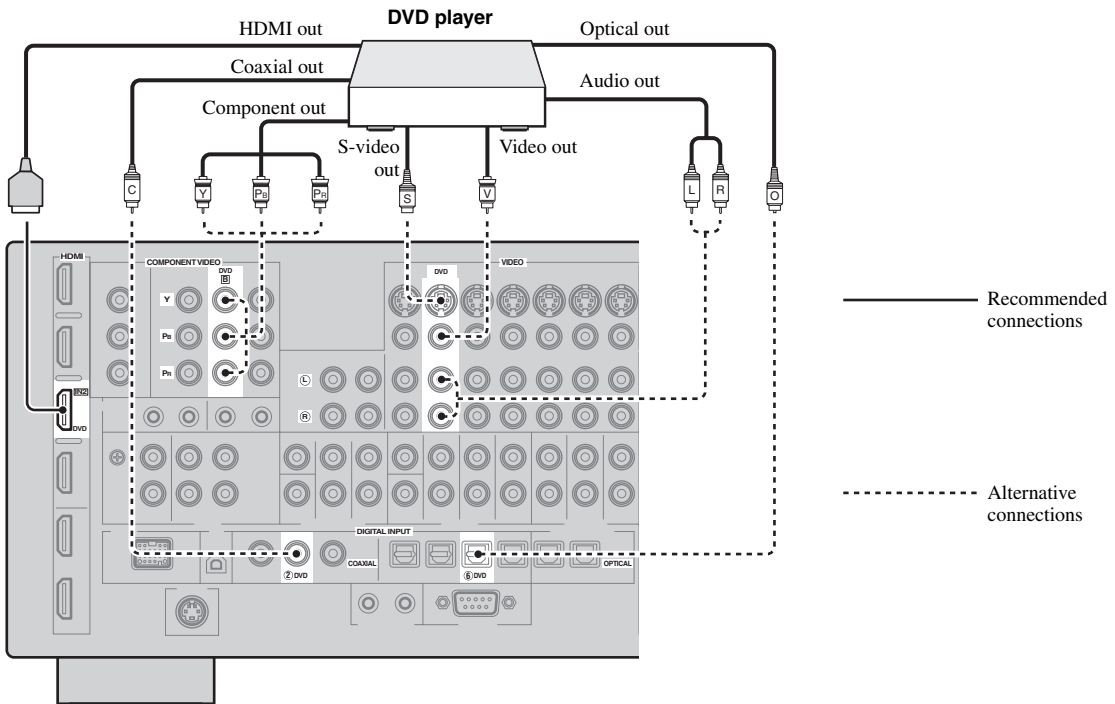

Jacks used for audio and video connections

Recommended connections are indicated by boldface. When connecting a recording component, you need to make additional connections for recording (signal transmission from this unit to the recording component).



Make sure that this unit and other components are unplugged from the AC wall outlets.



You can also use the VIDEO AUX jacks (page 24) on the front panel to connect an additional component.

Component	Signal type	Jacks to connect	
		On component	On this unit
Blu-ray Disc or HD DVD player	Audio/Video	HDMI out	HDMI IN1 (BD/HD DVD)
	Audio	Optical out	OPTICAL (BD/HD DVD)
		Audio out (analog)	AUDIO (BD/HD DVD)
	Video	Component out	COMPONENT VIDEO (BD/HD DVD)
		S-video out	S VIDEO (BD/HD DVD)
		Video out (composite)	VIDEO (BD/HD DVD)
DVD player	Audio/Video	HDMI out	HDMI IN2 (DVD)
	Audio	Optical out	OPTICAL (DVD)
		Coaxial out	COAXIAL (DVD)
		Audio out (analog)	AUDIO (DVD)
	Video	Component out	COMPONENT VIDEO (DVD)
		S-video out	S VIDEO (DVD)
Video out (composite)		VIDEO (DVD)	
Set-top box	Audio/Video	HDMI out	HDMI IN3 (CBL/SAT)
	Audio	Optical out	OPTICAL (CBL/SAT)
		Audio out (analog)	AUDIO (CBL/SAT)
		Video	Component out
	S-video out	S VIDEO (CBL/SAT)	
		Video out (composite)	VIDEO (CBL/SAT)
DVD recorder	Audio/Video	HDMI out	HDMI IN4 (DVR)
	Audio	Coaxial out	COAXIAL (DVR)
		Audio out (analog)	AUDIO (DVR IN)
		Video	S-video out
	Video out (composite)	VIDEO (DVR IN)	
	Audio recording	Optical in	OPTICAL (DVR)
		Audio in (analog)	AUDIO (DVR OUT)
	Video recording	S-video in	S VIDEO (DVR OUT)
		Video in (composite)	VIDEO (DVR OUT)

Component	Signal type	Jacks to connect	
		On component	On this unit
VCR	Audio	Audio out (analog)	AUDIO (VCR IN)
	Video	S-video out	S VIDEO (VCR IN)
		Video out (composite)	VIDEO (VCR IN)
	Audio recording	Audio in (analog)	AUDIO (VCR OUT)
	Video recording	S-video in	S VIDEO (VCR OUT)
Video in (composite)		VIDEO (VCR OUT)	
CD player	Audio	Coaxial out	COAXIAL (CD)
		Audio out (analog)	AUDIO (CD)
MD or CD recorder	Audio	Audio out (analog)	AUDIO (MD/CD-R IN)
	Audio recording	Optical in	OPTICAL (MD/CD-R)
		Audio in (analog)	AUDIO (MD/CD-R OUT)
Turntable	Audio	Audio out (analog)	AUDIO (PHONO)

Notes

- Be sure to make the same type of video connections as those made for your TV if the video conversion is disabled. For example, if you connected your TV to the VIDEO MONITOR OUT jack of this unit, connect other components to the VIDEO jacks.
- Check the copyright laws in your country to record from CDs, radio, etc. Recording of copyrighted material may infringe copyright laws.
- If you connect your DVD player to both the OPTICAL and COAXIAL jacks, priority is given to the signals input at the COAXIAL jack.
- GUI signals are not output at the DVR OUT and VCR OUT jacks and cannot be recorded.
- To make a digital connection to a component other than the default one assigned to each DIGITAL INPUT or DIGITAL OUTPUT jack, configure the “I/O Assignment” setting (page 98).
- When connecting a turntable with a low-output MC cartridge to the PHONO jack, use an in-line boosting transformer or MC-head amplifier.
- Connect your turntable to the GND terminal of this unit to reduce noise in the signal.

■ Connecting an external amplifier

This unit has more than enough power for any home use. However, if you want to add more power to the speaker output or if you want to use another amplifier, connect an external amplifier to the PRE OUT jacks. Each PRE OUT jack outputs the same channel signals as the corresponding SPEAKERS terminals.

Notes

- When you make connections to the PRE OUT jacks, do not make any connections to the SPEAKERS terminals.
- Adjust the volume level of the subwoofer with the control on the subwoofer.

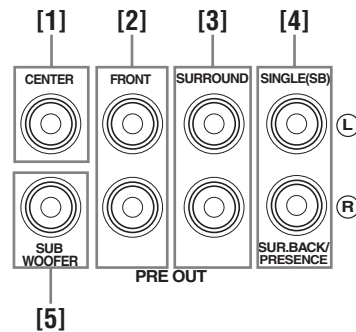

[1] CENTER PRE OUT jack

Center channel output jack.

[2] FRONT PRE OUT jacks

Front channel output jacks.

[3] SURROUND PRE OUT jacks

Surround channel output jacks.

[4] SUR.BACK/PRESENCE PRE OUT jacks

Surround back or presence channel output jacks. When you only connect one external amplifier for the surround back channel, connect it to the SINGLE (SB) jack.



- To output surround back channel signals at these jacks, set “Front Presence” to “None” and “Surround Back” to any parameter except “None” (page 88).
- To output presence channel signals at these jacks, set “Front Presence” to “Yes” and “Surround Back” to “None” (page 88).

[5] SUBWOOFER PRE OUT jack

Connect a subwoofer with a built-in amplifier.

■ Connecting a multi-format player or an external decoder

This unit is equipped with 6 additional input jacks (FRONT L/R, CENTER, SURROUND L/R and SUBWOOFER) for discrete multi-channel input from a multi-format player, external decoder, etc. If you set “Input Channels” to “8ch” (page 86), the analog audio input jacks assigned as “Front Input” can be used as the front channel input jacks.

Notes

- When you select “MULTI CH” as the input source, the digital sound field processor is automatically disabled.
- Since this unit does not redirect signals input at the MULTI CH INPUT jacks to accommodate for missing speakers, connect at least a 5.1-channel speaker system when using this feature.

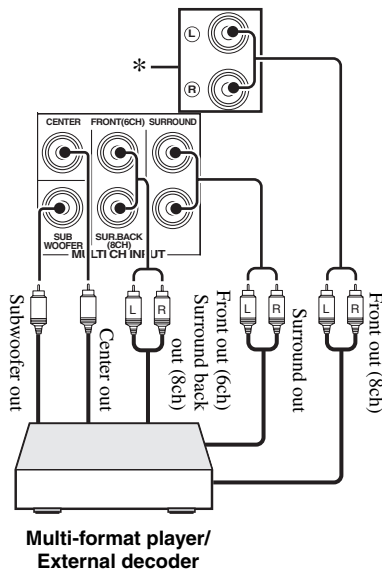

* The analog audio input jacks assigned as “Front Input” in “MULTI CH” (page 86).

■ Connecting a Yamaha iPod universal dock or Bluetooth wireless audio receiver

This unit is equipped with the DOCK terminal on the rear panel that allows you to connect a Yamaha iPod universal dock (such as YDS-11, sold separately) or Bluetooth wireless audio receiver (such as YBA-10, sold separately). Connect a Yamaha iPod universal dock or Bluetooth receiver to the DOCK terminal on the rear panel of this unit using its dedicated cable.

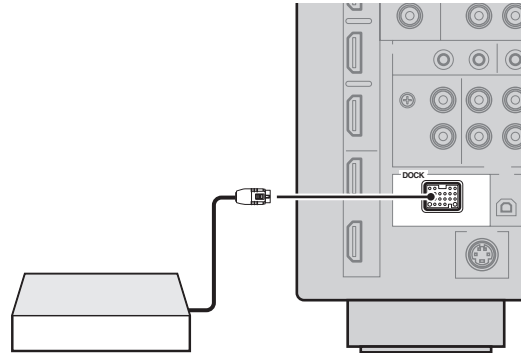

Yamaha iPod universal dock or Bluetooth wireless audio receiver

■ Using REMOTE IN/OUT jacks

When the components are the Yamaha products and have the capability of the transmission of the remote control signals, connect the REMOTE IN and REMOTE OUT jacks to the remote control input and output jack with the monaural analog mini cable as follows.

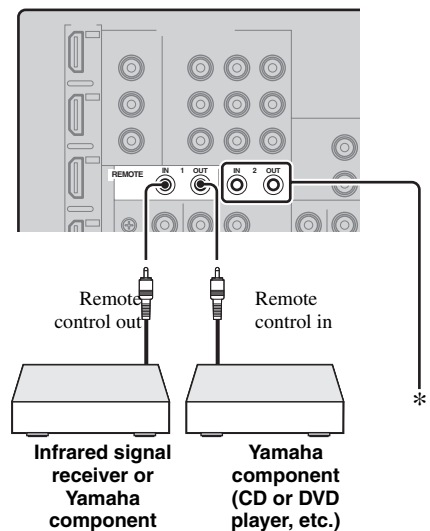

* You can connect another set of infrared signal receiver and Yamaha component to the REMOTE IN/OUT 2 jacks same as the REMOTE IN/OUT 1 jacks.

■ Connecting to the network

To connect this unit to your network, plug one end of a network cable (CAT-5 or higher straight cable) into the NETWORK port of this unit, and plug the other end into one of the LAN ports on your router that supports the DHCP (Dynamic Host Configuration Protocol) server function. The following diagram shows a connection example where this unit is connected to one of the LAN ports on a 4-port router. To enjoy music files saved on your PC and Yamaha MCX-2000, access the Internet Radio, or control this unit by using your PC, each device must be connected properly in the network.

Notes

- You must use an STP (shielded twisted pair) cable (commercially available) to connect a network hub or router and this unit.
- If the DHCP server function on your router is disabled, you need to configure the network settings manually (page 95).
- Yamaha MCX-2000, MCX-A10 and MCX-C15 may not be for sale in some locations.

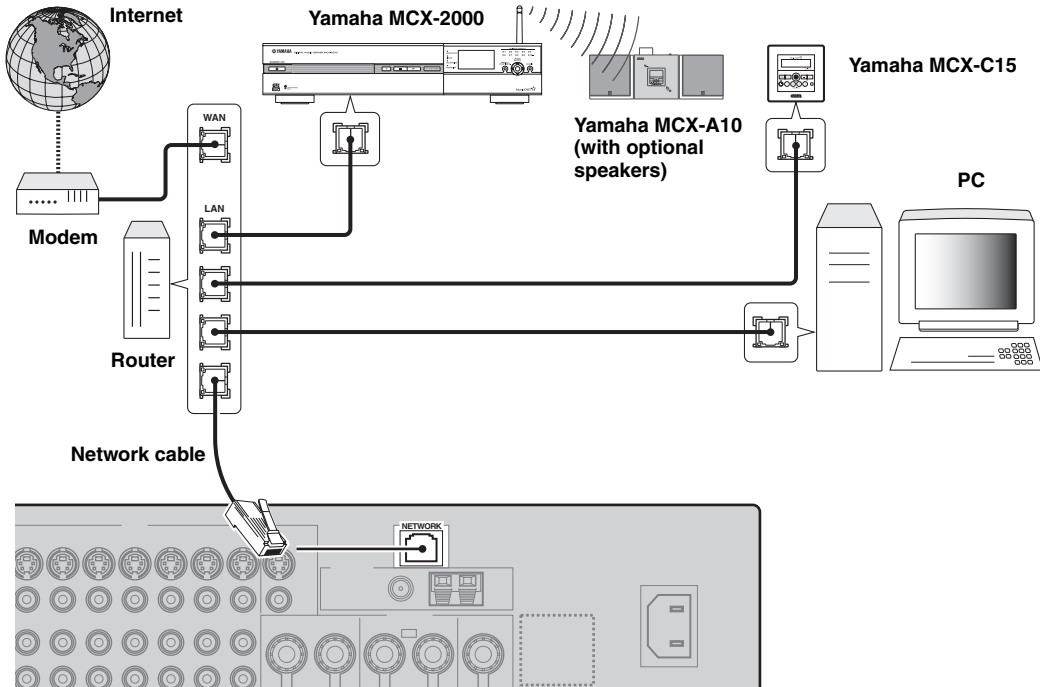

■ Connecting a USB storage device

Connect a USB memory device or USB portable audio player to the USB port on the front panel of this unit. For information about the USB storage devices supported by this unit, see page 69.

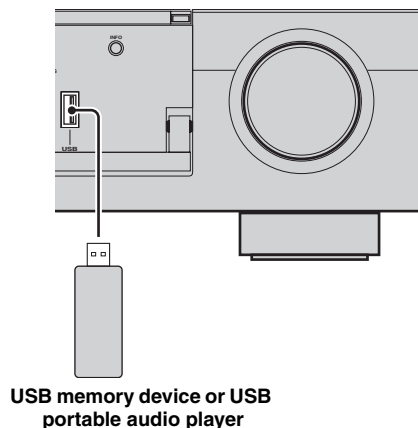

Using the VIDEO AUX jacks on the front panel

Use the VIDEO AUX jacks on the front panel to connect a game console or a video camera to this unit. To reproduce the source signals input at these jacks, select “V-AUX” as the input source.

Caution

Be sure to turn down the volume of this unit and other components before making connections.

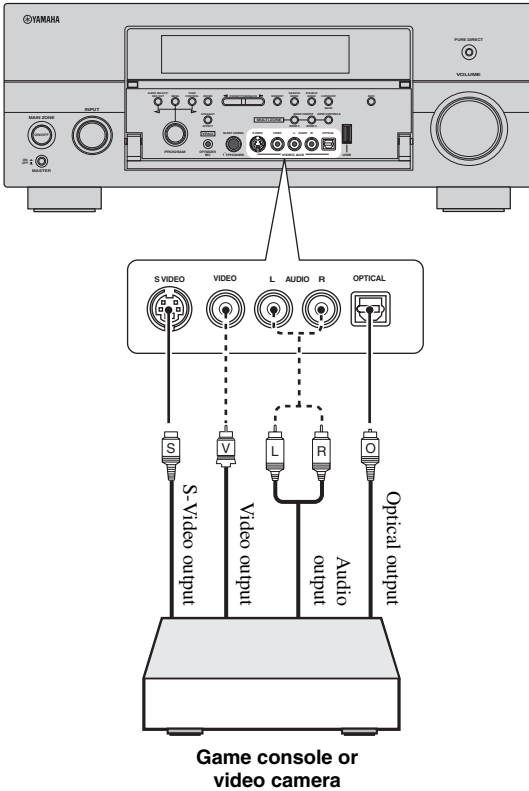

Connecting the FM and AM antennas

Both FM and AM indoor antennas are supplied with this unit. In general, these antennas should provide sufficient signal strength.

Notes

- The types of the supplied antennas and the FM antenna terminal of this unit are different depending on the models.
- (Asia and General models only) Be sure to set the tuner frequency step according to the frequency spacing in your area (page 122).
- The AM loop antenna should be placed away from this unit.
- The AM loop antenna should always be connected, even if an outdoor AM antenna is connected to this unit.
- If you experience poor reception quality, install an outdoor antenna. Consult the nearest authorized Yamaha dealer or service center about outdoor antennas.

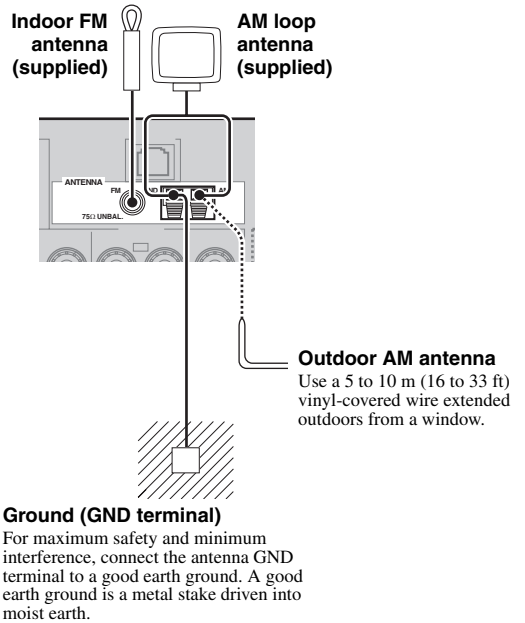

Assembling the supplied AM loop antenna

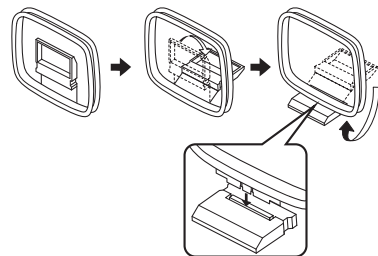

(U.S.A. model)

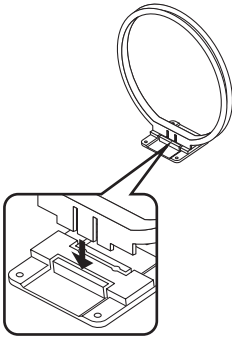

Connecting the wire of the AM loop antenna

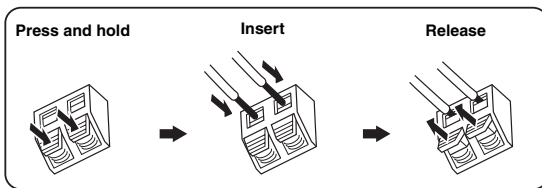

The wire of the AM loop antenna does not have any polarity and you can connect either end of the wire to AM or GND terminal.

Connecting the power cable

■ Connecting the AC power cable

Plug the supplied AC power cable into the AC inlet after all other connections are complete, then plug the AC power cable into an AC wall outlet.

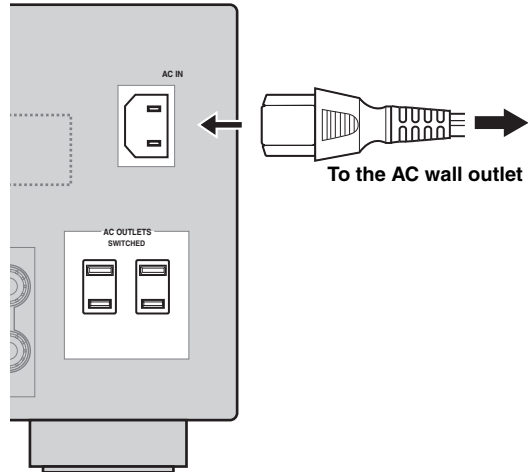

Note

(Asia model only) Select one of the supplied power cables suitable for the type of AC wall outlet in your location before plugging this unit into the AC wall outlet.

■ AC OUTLET(S) (SWITCHED)

U.K. and Australia models 1 outlet
 Korea model None
 Other models 2 outlets

Use these outlet(s) to supply power to any connected components. Connect the power cable of your other components to these outlet(s). Power to these outlet(s) is supplied when this unit is turned on. However, power to these outlet(s) is cut off when this unit is turned off. For information on the maximum power or the total power consumption of the components that can be connected to these outlet(s), see “Specifications” (page 145).



The rated power of the component (such as a subwoofer) connected to these outlet(s) cannot exceed the maximum power supplied by this unit.

Memory back-up

The memory back-up circuit prevents the stored data from being lost even if this unit is in the standby mode. However, the stored data will be lost in case the power cable is disconnected from the AC wall outlet or if the power supply is cut off for more than one week.

Setting the speaker impedance and GUI language

Caution

If you are to use 6 ohm speakers, set “SPEAKER IMP:” to “6Ω MIN” as follows BEFORE using this unit. You can also use 4 ohm speakers as the front speakers (page 121).

- 1 Make sure this unit is turned off.
- 2 Press and hold **ⓃSTRAIGHT** on the front panel and then press **ⒶMASTER ON/OFF** inward to the ON position.
This unit turns on, and the advanced setup menu appears in the front panel display.



- 3 Rotate the **ⓂPROGRAM** selector to select “SPEAKER IMP.”.
- 4 Press **ⓃSTRAIGHT** repeatedly to select “6Ω MIN”.
- 5 Rotate the **ⓂPROGRAM** selector to select “LANGUAGE”.
- 6 Press **ⓃSTRAIGHT** to select desired language setting for the GUI screen in the video monitor.
Choices: **ENGLISH** (English), **JAPANESE** (Japanese), **FRENCH** (French), **GERMAN** (German), **SPANISH** (Spanish), **RUSSIAN** (Russian)

Notes

- For details about the display language, see “Language” (page 123)
- You can also select the display language with the GUI menu (page 100).

- 7 Press **ⒶMASTER ON/OFF** to release it outward to the OFF position to save the new setting and turn off this unit.

Note

The setting you made is reflected next time you turn on this unit.

Turning this unit on and off

Turning on this unit

Press **ⒶMASTER ON/OFF** on the front panel inward to the ON position.

When you turn on this unit by pressing **ⒶMASTER ON/OFF**, the main zone is turned on.

Turning off this unit

Press **ⒶMASTER ON/OFF** on the front panel again to release it outward to the OFF position.

Set the main zone to the standby mode

Press **ⒷMAIN ZONE ON/OFF** (or **ⒾSTANDBY**).

Turning on the main zone from the standby mode

Press **ⒷMAIN ZONE ON/OFF** (or **ⓅPOWER**).



- Basically, we recommend that you use the standby mode to turn off this unit. In the standby mode, this unit consumes a small amount of power in order to receive infrared signals from the remote control.
- **ⒷMAIN ZONE ON/OFF**, **ⒾSTANDBY** and **ⓅPOWER** are operational only when **ⒶMASTER ON/OFF** is pressed inward to the ON position.
- When you turn on this unit, there will be a delay for a few seconds before this unit can reproduce sound.

If there are some problems...

- First, turn off and then turn on this unit again.
- If problems persist, initialize the parameters of this unit (page 138).

Front panel display

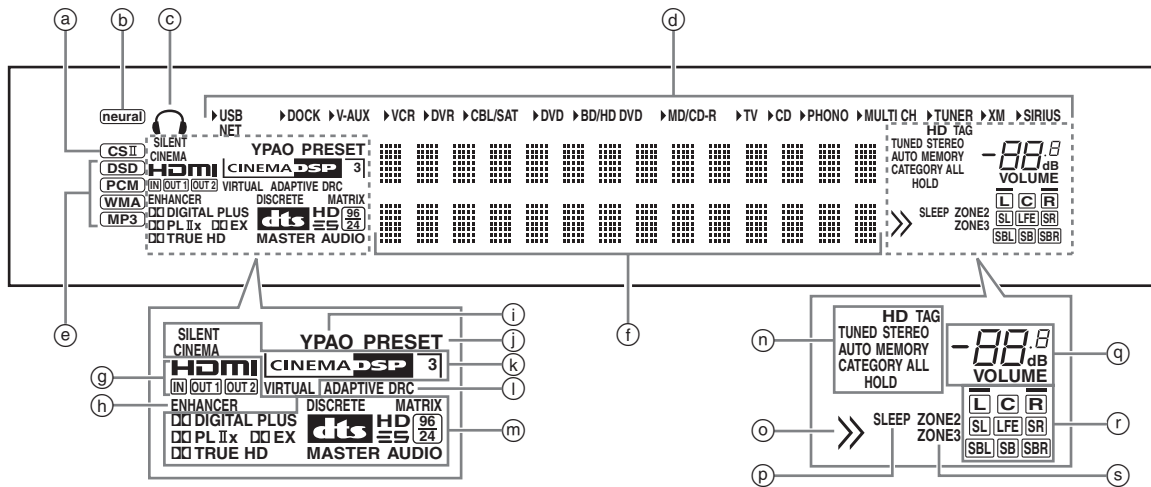

Ⓐ CSII indicator (U.S.A. model only)

Lights up when the SRS Circle Surround II decoder is active (page 74).

Ⓑ neural indicator (U.S.A. and Canada models only)

Lights up when the Neural-THX Surround decoder is active (page 74).

Ⓒ Headphones indicator

Lights up when headphones are connected (page 38).

Ⓓ Input source indicators

The corresponding cursor lights up to show the currently selected input source.

Notes

- The XM and SIRIUS indicators are only applicable to the U.S.A. and Canada models.
- The NET indicator also lights up when "Network Standby" (page 96) is set to "On" and this unit is in the standby mode.

Ⓔ Input signal indicators

The respective indicator lights up when this unit is reproducing DSD (Direct Stream Digital), PCM (Pulse Code Modulation), WMA (Windows Media Audio) or, MP3 (MPEG-1 Audio Layer-3) audio signals.

Ⓕ Multi-information display

Shows the name of the current sound field program and other information when adjusting or changing settings.

Ⓖ HDMI indicator

IN indicator

Lights up when the signal of the selected input source is input at one of the HDMI input jacks (page 16).

OUT 1/OUT 2 indicator

The respective indicator lights up when the HDMI signal is output at the HDMI OUT jacks. (page 16).

Ⓗ ENHANCER indicator

Lights up when the Compressed Music Enhancer mode is turned on (page 45).

Ⓙ YPAO indicator

Lights up when you run the automatic setup and when the speaker settings configured by the automatic setup are used without any modifications (page 30).

Ⓚ PRESET indicator

Lights up while this unit is in the preset tuning mode.

Ⓛ DSP indicators

The respective indicator lights up when any of the sound field programs are selected.

SILENT CINEMA indicator

Lights up when headphones are connected and a sound field program is selected (page 45).

CINEMA DSP indicator

Lights up when you select a CINEMA DSP sound field program (page 40).

3D indicator

Lights up when the CINEMA DSP 3D mode is turned on (page 46).

VIRTUAL indicator

Lights up when Virtual CINEMA DSP is active (see page 45).

Ⓛ ADAPTIVE DRC indicator

Lights up when the adaptive dynamic range control feature is turned on (page 89).

Ⓜ Decoder indicators

The respective indicator lights up when any of the decoders of this unit function.

Ⓝ Tuner indicators

Light up when this unit is in the FM, AM, XM Satellite Radio, or SIRIUS Satellite Radio tuning mode.

Note

The HD and TAG indicators are only applicable to the U.S.A. model and used when this unit is tuned into the HD Radio reception band.

Ⓞ Menu browsing indicator

Lights up if any items exist under the current item during menu browsing for iPod, etc.

Ⓟ SLEEP indicator

Lights up while the sleep timer is on (page 39).

Ⓠ VOLUME level indicator

- Indicates the current volume level.
- Flashes while the mute function is on (page 38).

Ⓡ Input channel and speaker indicators

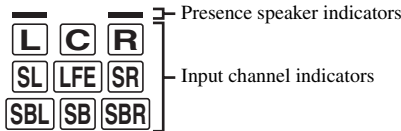

Input channel indicators

- Indicate the channel components of the current digital input signal.
- Light up or flash according to the settings of the speakers when this unit is in the automatic setup procedure (page 30).

Presence speaker indicators

Light up according to setting for “Front Presence” (page 88) in “Configuration” when this unit is in the auto setup procedure (page 30) or the speaker level setting procedure in the “Level” (page 89).

Ⓢ ZONE2/ZONE3 indicators

Lights up when Zone 2 or Zone 3 is turned on (page 119).

Using the remote control

The remote control transmits a directional infrared ray. Be sure to aim the remote control directly at the remote control sensor on this unit during operation.

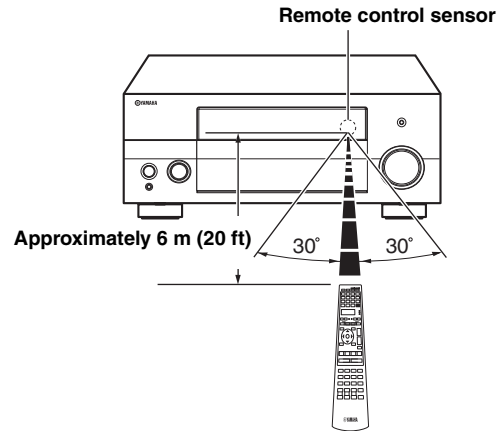

Ⓣ LIGHT

Lights up the remote control buttons and the display window (④).

Display window (④)

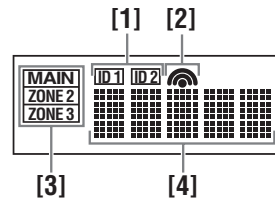

[1] ID1/ID2 indicator

Indicates the currently selected remote control ID (page 121).

[2] Transmit indicator

Appears while the remote control is sending infrared signals.

[3] Zone indicators

Indicates the currently controlling zone (page 119).

[4] Information display

Shows the name of the selected input source that you can control.

Infrared window (①)

Outputs infrared control signals. Aim this window at the component you want to operate.

Operation mode selector (18)

The function of some buttons depends on the operation mode selector position.

AMP

Operates the amplifier function of this unit.

SOURCE

Operates the component selected with an input selector button (page 107).

TV

Operates the TV (page 106).

Notes

- Do not spill water or other liquids on the remote control.
- Do not drop the remote control.
- Do not leave or store the remote control in the following conditions:
 - places of high humidity, such as near a bath
 - places of high temperatures, such as near a heater or stove
 - places of extremely low temperatures
 - dusty places
- To set the remote control codes for other components, see page 109.

Opening and closing the front panel door

When you want to use the controls behind the front panel door, open the door by gently pressing on the lower part of the panel. Keep the door closed when not using these controls.

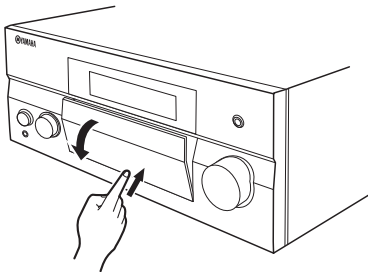

Optimizing the speaker setting for your listening room

This unit employs the YPAO (Yamaha Parametric room Acoustic Optimizer) technology which lets you avoid troublesome listening-based speaker setup and achieves highly accurate sound adjustments automatically. The supplied optimizer microphone collects and this unit analyzes the sound your speakers produce in your actual listening environment.

This unit is equipped with various automatic setup features. You can select the automatic setup features according to your preference.

Quick automatic setup (page 30)

Use this feature to carry out the automatic setup without using the GUI screen.

Basic automatic setup (page 31)

Use this feature to optimize the setup of this unit for one listening position. You can also select the parameters to be optimized by the automatic setup.

Advanced automatic setup (page 33)

Use this feature to optimize the setup of this unit for multiple listening positions. You can also select the parameters to be optimized by the automatic setup.

Before starting the automatic setup

Make sure of the following check points before starting the automatic setup operations.

- Speakers are connected appropriately.
- Headphones are disconnected from this unit.
- This unit is turned on.
- The connected subwoofer is turned on and the volume level is set to about half way (or slightly less).
- The crossover frequency controls of the connected subwoofer is set to the maximum.

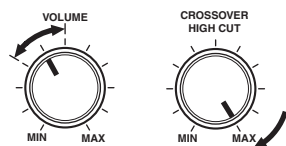

Controls of a subwoofer (example)

- The room is sufficiently quiet.
- Set the operation mode selector on the remote control to **AMP**.

Notes

- Be advised that it is normal for loud test tones to be output during the automatic setup procedure.
- To achieve the best results, make sure the room is as quiet as possible while the automatic setup procedure is in progress. If there is too much ambient noise, the results may not be satisfactory.

Quick automatic setup

Use this feature to carry out the automatic setup without using the GUI screen.

- 1 Connect the supplied optimizer microphone to the OPTIMIZER MIC jack on the front panel.



Omni-directional microphone

The following screen appears in the front panel display.

AUTO SETUP
ENTER TO START

Note

“View GUI Menu” appears if the GUI menu screen is turned on. In this case, press **MENU** to turn off the GUI menu screen or follow “Basic automatic setup” (page 31).

- 2 Place the optimizer microphone at your normal listening position on a flat level surface with the omni-directional microphone heading upward.

Optimizer microphone

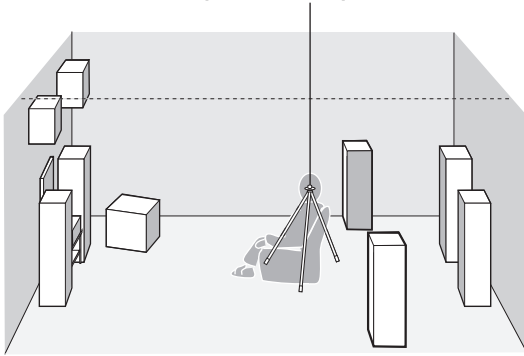

It is recommended that you use a tripod (etc.) to affix the optimizer microphone at the same height as your ears would be when you are seated in your listening position. You can use the attached screw of a tripod (etc.) to fix the optimizer microphone to the tripod (etc.).

Before proceeding next operation

Once you perform the next operation, this unit starts the automatic setup procedure in 10 seconds. During the automatic setup procedure, do not perform any operation on this unit. For more accurate measurements, we recommended that you get out of the room or move to the wall where speakers are not around during the measurement. It takes approximately 3 minutes.

3 Press ENTER to start the measurement.

This unit starts to count down from 10 seconds.



- To start the measurement immediately, press ENTER again.
- To cancel the automatic setup and return to the previous screen, press RETURN .

Loud test tones are output from each speaker during the measurement. Once all items are measured, “COMPLETED” appears.

COMPLETED
PLS UNPLUG MIC

Note

If an error or warning message appears, see “Automatic setup” (page 136).

ERROR: E-01
PRESS ENTER

4 Disconnect the optimizer microphone to complete the automatic setup.



You can check the results of the measurements by using the GUI screen (page 34).

Basic automatic setup

Use this feature to optimize the setup of this unit this unit for one listening position. You can also select the parameters to be optimized in the automatic setup.

1 Turn on the video monitor and then follow steps 1 and 2 in “Quick automatic setup” (page 30).

2 Press MENU on the remote control.

The following screen (GUI menu) appears in the video monitor.

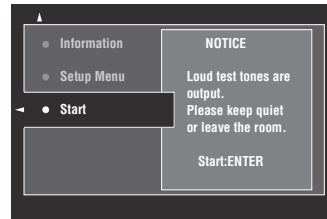

3 To select the parameters to be optimized, press UP to select “Setup Menu” and then press RIGHT .

When you do not need to select the parameters to be optimized, skip to step 6.



If you do not select the parameters to be optimized, this unit will optimize the parameters you selected last time. All the parameters are selected by the initial factory settings.

4 Press UP / DOWN repeatedly to select the parameter and then press ENTER to check or uncheck the box.

Check the boxes for the parameters to be optimized.

Parameter	Descriptions
Multi Measure (Multiple point measurement)	You can optimize the setup of this unit for multiple listening positions. For details, see “Advanced automatic setup” (page 33). In the basic automatic setup, leave this setting to the default.
Wiring (Speaker wiring)	This unit checks and adjusts which speakers are connected and the polarity of each speaker.

Parameter	Descriptions
Distance (Speaker distance)	This unit checks and adjusts the distance of each speaker from the listening position and adjusts the timing of each channel.
Size (Speaker size)	This unit checks and adjusts the frequency response of each speaker and sets the appropriate low-frequency crossover for each channel.
Equalizing (Speaker equalizing)	Parametric equalizer adjusts the level of the specified frequency bands. This unit automatically selects the crucial frequency bands for the listening room and adjusts the level of the selected frequency bands to create a cohesive sound field in the room.
Level (Speaker level)	This unit checks and adjusts the volume level of each speaker.

5 If you have finished the settings, press **⏪** to return to the previous menu level and then press **⏴** to select “Start”.

Before proceeding next operation

Once you perform the next operation, this unit starts the automatic setup procedure in 10 seconds. During the automatic setup procedure, do not perform any operation on this unit. For more accurate measurements, we recommended that you get out of the room or move to the wall where speakers are not around during the measurement. It takes approximately 3 minutes.

6 Press **ENTER** to start the measurement.

This unit starts to count down from 10 seconds.



- To start the measurement immediately, press **ENTER** again.
- To cancel the automatic setup and return to the previous screen, press **RETURN**.

Loud test tones are output from each speaker during the measurement. Once all items are measured, “Measurement Completed Successful” appears.

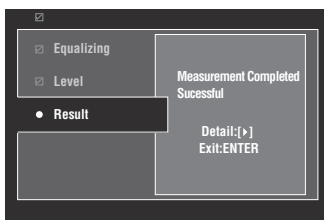

Note

If an error or warning message appears, see “Error and warning messages” (page 32).

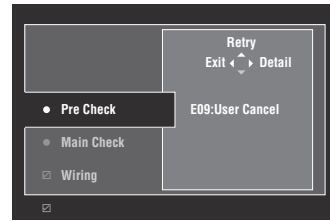

7 Press **ENTER** to exit from the “Result” screen.



- To view the measurement results in detail, press **⏩**. Press **⏴** / **⏵** repeatedly to toggle between parameters (page 35). Press **⏪** to return to the “Result” screen.
- To retry the measurement from step 4, press **⏴**.

8 Press **⏪** to save the measurement results or **⏩** to discard them.

9 Press **MENU** to turn off the GUI menu and disconnect the optimizer microphone.

Error and warning messages

If an error or warning message appears during the automatic setup procedure, carry out one of the following operations. For details on each message, see “Automatic setup” (page 113).

- To view the details on the error and warning messages, press **⏩**. Press **⏴** / **⏵** to display the previous/next page (if available). Press **⏪** to return to the previous menu level.
- To return to the GUI menu, press **⏪**.
- To retry the measurement, press **⏴**.
- To ignore the message and continue the process, press **⏵**.

Note

Some operations cannot be performed depending on the type of error (or warning).

Advanced automatic setup

Use this feature to optimize the setup of this unit for multiple listening positions. You can also select the parameters to be optimized by the automatic setup.

1 Turn on the video monitor and then connect the optimizer microphone to the OPTIMIZER MIC jack on the front panel.

2 Place the optimizer microphone at the first listening position.

The following illustration shows how to place the optimizer microphone in order to optimize the setup of this unit for seven listening positions for example.

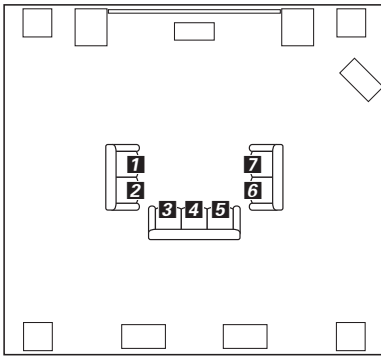

1/2/3/4/5/6/7: Listening positions

3 Press MENU on the remote control.
The GUI menu appears in the video monitor.

4 Press Δ to select "Setup Menu" and then press \triangleright .

5 Press Δ / ∇ repeatedly to select "Multi Measure" and then press \triangleright .

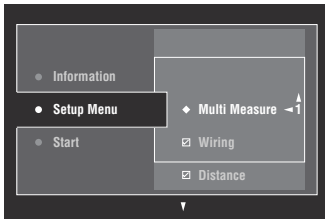

6 Press Δ / ∇ repeatedly to set the number of listening positions and press \triangleleft .

Choices: 1 (default), 2, 3, 4, 5, 6, 7, 8

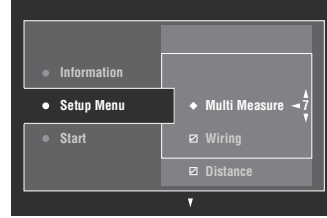

7 To select the parameters to be optimized, press Δ / ∇ to select the parameter and then press ENTER to check or uncheck the box.

When you do not need to select the parameters to be optimized, skip to step 8.



If you do not select the parameters to be optimized, this unit will optimize the parameters you selected last time. All the parameters are selected by the initial factory settings.

8 Press \triangleleft to return to the previous menu level and then press ∇ to select "Start".

Before proceeding next operation

Once you perform the next operation, this unit starts the automatic setup procedure in 10 seconds. During the automatic setup procedure, do not perform any operation on this unit. For more accurate measurements, we recommended that you get out of the room or move to the wall where speakers are not around during the measurement.

9 Press ENTER to start the measurement.

This unit starts to count down from 10 seconds.



- To start the measurement immediately, press ENTER again.
- To cancel the automatic setup and return to the previous screen, press RETURN .

Loud test tones are output from each speaker during the measurement. Once all items for the first listening position are measured, the following message appears.

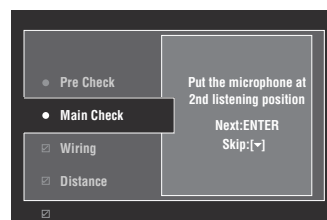

Note

If an error or warning message appears, see “Error and warning messages” (page 32).

-
- 10 Move the optimizer microphone to the second listening position and then press $\text{\textcircled{9}}$ ENTER to start the measurement.**



To skip the measurements at the remaining listening positions, press $\text{\textcircled{9}}\nabla$.

-
- 11 Repeat step 10 until the measurement at all listening positions are made.**

If you have made the measurement at all listening positions or skipped the measurement at the remaining listening positions, “Measurement Completed Successful” appears.

-
- 12 Follow steps 7 to 9 in “Basic automatic setup” (page 31) to view the measurement results and turn off the GUI menu.**

Reviewing and reloading the automatic setup parameters

Use this feature to review the result of the automatic setup. You can also reload the automatic setup parameters in case you are not satisfied with the speaker setup and sound adjustments you have configured manually.

Note

If you reload the automatic setup parameters, the settings you have configured manually are cleared. To save the settings before reloading the automatic setup parameters, see “System Memory” (page 101).

-
- 1 Set the operation mode selector to $\text{\textcircled{16}}$ AMP and then press $\text{\textcircled{19}}$ MENU.**

The GUI menu appears in the video monitor.



If the menu directory other than “Top Menu” (page 79) is displayed, press and hold $\text{\textcircled{19}}$ MENU to display the top GUI menu.

-
- 2 Press $\text{\textcircled{9}}\Delta / \nabla$ repeatedly to select “Setup” and then press $\text{\textcircled{9}}\triangleright$.**

-
- 3 Press $\text{\textcircled{9}}\Delta / \nabla$ repeatedly to select “Auto Setup” and then press $\text{\textcircled{9}}\triangleright$.**

-
- 4 Press $\text{\textcircled{9}}\Delta$ to select “Information” and then press $\text{\textcircled{9}}\triangleright$.**

-
- 5 Press $\text{\textcircled{9}}\Delta / \nabla$ repeatedly to select the parameter of which you want to check the setting.**

Parameter	Descriptions
Multi Measure (Multiple point measurement)	Displays the number of listening position actually measured.
Wiring (Speaker wiring)	Displays the polarity of each connected speaker. <ul style="list-style-type: none"> – “NRM” appears when the polarity of the connected speaker is normal. – “REV” appears when the polarity of the connected speaker is reversed. – “DET” appears when this unit detects the subwoofer is connected. – “----” appears when no speaker is connected to the corresponding speaker channel.
Distance (Speaker distance)	Displays the speaker distance from the listening position. Press repeatedly to switch the unit to display the value of the each speaker distance.
Size (Speaker size)	Displays the size of the connected speakers and the bass cross over frequency (“Cross”). <ul style="list-style-type: none"> – “LRG” appears when the connected speaker has the ability to reproduce the low-frequency signals effectively. – “SML” appears when the connected speaker does not have the ability to reproduce the low-frequency signals effectively.
Equalizing (Speaker equalizing)	Displays the result of the adjustment of the frequency responses of each connected speaker. You can switch the parametric equalizer type that appears in the result display by pressing repeatedly in the “Equalizing” result display. To apply the result that is displayed in the display, press . <p>Choices: Natural, Flat, Front</p> <ul style="list-style-type: none"> – Select “Natural” to average out the frequency response of all speakers with higher frequencies being less emphasized. Recommended if the “Flat” setting sounds a little harsh. – Select “Flat” to average the frequency response of all speakers. Recommended if all of your speakers are of similar quality. – Select “Front” to adjust the frequency response of each speaker in accordance with the sound of your front speakers. Recommended if your front speakers are of much higher quality than your other speakers.
Level (Speaker level)	Displays the result of the adjustment of each connected speaker output level. You can display the result of the adjustment of the speaker level for each parametric equalizer type (see above) by pressing repeatedly. Select “Through” to display the result when this unit does not use the parametric equalizer.

Notes

- “----” appears when no speaker is connected to the corresponding speaker channel or this unit does not measure the corresponding speaker channel yet.
- If you change speakers, speaker positions, or the layout of your listening environment, run the automatic setup again to recalibrate your system.
- The distances displayed in the “Distance” results may be longer than the actual distance depending on the characteristics of your subwoofer or external amplifiers if you connect them.
- In the “Equalizing” results, different values may be set for the same band to provide finer adjustments.

6 To reload the displayed parameter, press .

7 Press to turn off the GUI menu.



- You can also set the parametric equalizer type with “PEQ Select” (page 91).
- You can set the phase of the connected subwoofer with “Phase” (page 88).



The results of the measurement that are the causes of the warning message(s) appear in yellow or pink.

Playback

Caution

Extreme caution should be exercised when you play back CDs encoded in DTS. If you play back a CD encoded in DTS on a DTS-incompatible CD player, you will only hear some unwanted noise that may damage your speakers. Check whether your CD player supports CDs encoded in DTS. Also, check the sound output level of your CD player before you play back a CD encoded in DTS.



To play DTS-encoded CDs when using a digital audio connection, set "Decoder Mode" in "Input Select" to "DTS" before the playback (page 85).

Before performing the following operations, set the operation mode selector on the remote control to **AMP**.

Basic procedure

1 Turn on the video monitor connected to this unit.



- If you connect two video monitors to the HDMI OUT jacks of this unit, press **HDMI OUT** repeatedly to select the active video monitor(s). See page 37 for details.
- You can operate this unit by using the graphical user interface (GUI) screen (page 76).
- You can configure the display settings with "Video" (page 93) and "Display Set" (page 98).

2 Rotate the **INPUT** selector (or press one of the input selector buttons (3))

The name of the selected input source appears for a few seconds.

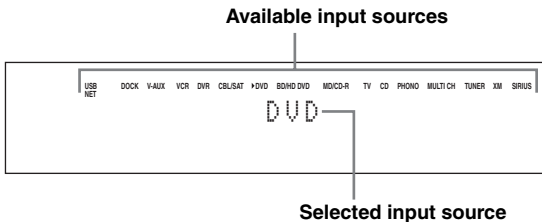

3 Start playback on the selected source component or select a broadcast station.

- Refer to the instruction manuals for the source component.
- FM/AM radio tuning (page 48)
- XM Satellite Radio tuning (page 53)
- SIRIUS Satellite Radio tuning (page 58)
- Bluetooth component playback (page 64)
- iPod playback (page 66)
- Playback via USB or network (page 68)

4 Rotate **VOLUME** (or press **VOLUME +/-**) to adjust the volume to the desired output level.



To adjust the level of each speaker, see page 47.

5 Rotate the **PROGRAM** selector (or press one of the sound field program selector buttons (7)) repeatedly) to select the desired sound field program.

For details about sound field program, see page 40.

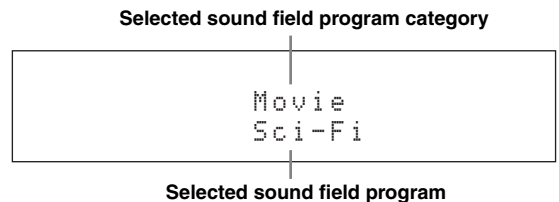

To switch the information (current input source, current sound field program, etc) displayed in the front panel display, press **INFO** (or set the operation mode selector to **AMP** and then press **INFO**) repeatedly.

Selecting audio input jacks (AUDIO SELECT)

Use this feature (audio input jack select) to switch the input jack assigned to an input source when more than one jacks are assigned to an input source.

- 1 Rotate the **ⒸINPUT** selector (or press one of the input selector buttons (**Ⓒ**)) to select the desired input source.
- 2 Press **ⒹAUDIO SELECT** and then rotate **ⓂPROGRAM** selector (or set the operation mode to **ⒺAMP** and then press **ⒺAUDIO SEL** repeatedly) to select the desired audio input jack select setting.

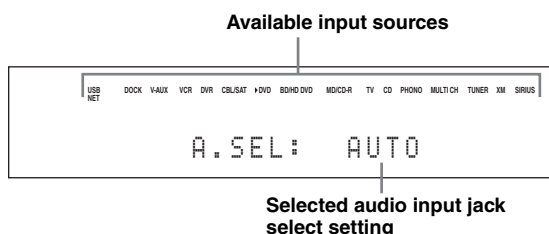

AUTO	Automatically selects input signals in the following order: (1) HDMI (2) Digital signals (3) Analog signals
HDMI	Selects only HDMI signals. When HDMI signals are not input, no sound is output.
COAX/OPT	Automatically selects input signals in the following order: (1) Digital signals input at the COAXIAL jack. (2) Digital signals input at the OPTICAL jack. When no signals are input, no sound is output.
ANALOG	Selects only analog signals. If no analog signals are input, no sound is output.

You can configure the default audio input jack select setting with “Audio Select” (page 85).

Note

This feature is not available if no digital input jack is assigned to the selected input source in “I/O Assignment” (page 98). “HDMI” is available only when an HDMI input jack is assigned.

Selecting the multi-channel input component

Use this feature to select the component connected to the MULTI CH INPUT jacks (page 22) as the input source.

Rotate the **ⒸINPUT** selector on the front panel to select “MULTI CH” (or press **ⒸMULTI**).

You can configure the multi channel input settings with “MULTI CH” (page 85).

Note

Sound field programs cannot be selected when “MULTI CH” is selected as the input source.

Selecting the HDMI OUT jack

Use this feature to select the HDMI OUT jack(s) to output the input signals.

Set the operation mode selector to **ⒺAMP** and then press **ⒺHDMI OUT** on the remote control repeatedly to select the desired setting.

The HDMI output setting changes as follows.

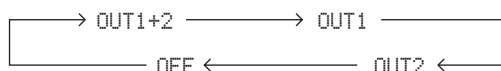

OUT 1+2	Outputs the signals at both the HDMI OUT 1 and HDMI OUT 2 jacks simultaneously.
OUT 1	Outputs the signals at the HDMI OUT 1 jack.
OUT 2	Outputs the signals at the HDMI OUT 2 jack.
OFF	Does not output any signals at the HDMI OUT 1 and HDMI OUT 2 jacks. Select this setting when you do not use the video monitor connected to one of the HDMI OUT jacks.

You can select the HDMI OUT jack at which HDMI control signals are output with “Control Monitor” (page 95).

Using your headphones

Connect a pair of headphones with a stereo analog audio cable plug to the PHONES jack on the front panel.

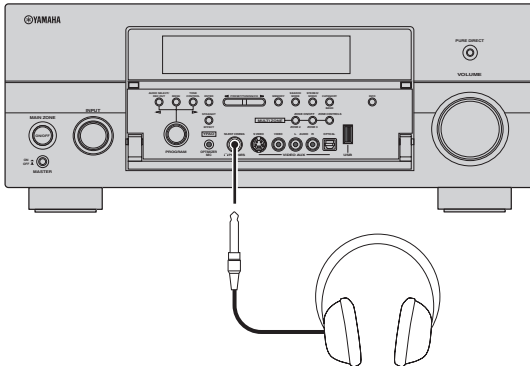

When you select a sound field program, SILENT CINEMA mode activates automatically (page 45).

Notes

- When you connect headphones, no signals are output at the speaker terminals.
- All digital multi-channel audio signals are mixed down to the left and right headphone channels.
- When “MULTI CH” is selected as the input source, only the signals input at the MULTI CH INPUT FRONT jacks are output.

Muting the audio output

Press **MUTE** on the remote control to mute the audio output. Press **MUTE** again to resume the audio output.



- The VOLUME level indicator flashes while the mute function is on.
- You can configure the muting level with “Muting Type” (page 90).

Displaying the input source information

You can display the format, sampling frequency, channel, bit rate and flag data of the current input signal.

- 1 Set the operation mode selector to **AMP** and then press **STATUS** on the remote control.
The input source information screen appears in the GUI screen.
- 2 Press **◀ / ▶** to toggle between the audio and video information.
- 3 Press **STATUS** on the remote control again to exit from the input source information screen.

Audio information

Format	Signal format. When this unit cannot detect a digital signal, it automatically switches to analog input.
Sampling	The number of samples per second taken from a continuous signal to make a discrete signal.
Channel	The number of source channels in the input signal (front/surround/LFE). For example, a multi-channel soundtrack with 3 front channels, 2 surround channels and LFE, is displayed as “3/2/0.1”.
Bitrate	The number of bits passing a given point per second.
Dialogue	The dialogue normalization level preset to the current input bitstream signal.
Flag1/Flag2	Flag data encoded in the bitstream, or PCM signals that cue this unit to automatically switch decoders.

Notes

- “—” appears when this unit cannot display the corresponding information.
- Some high definition audio bitstream contents may not include the discrete surround back left and right channel signals but are encoded at the bitrate of 192 kHz.
- Even if you make settings to output bitstreams directly, some players convert the Dolby TrueHD or Dolby Digital Plus bitstreams to the Dolby Digital bitstreams, while converting the DTS-HD Master Audio or DTS-HD High Resolution Audio bitstreams to the DTS bitstreams.

■ Video information

HDMI signal	Type of the source video signals and the video signals output at the HDMI OUT jacks of this unit.
HDMI Resolution	Resolution of the input signal (analog or HDMI) and the output signal (HDMI).
Analog Resolution	Resolution of the source video signals and the analog video signals output at the COMPONENT MONITOR OUT jacks of this unit.
HDMI Error	Error message for HDMI sources or connected HDMI devices.

HDMI error message

Device Over	The number of the connected HDMI components is over the limit.
HDCP Error (HDMI Message)	HDCP authentication failed.
Out Of Resolution	Out of resolution. The connected monitor is not compatible with the resolution of the input video signal.

Using the sleep timer

Use this feature to automatically set the main zone to the standby mode after a certain amount of time. The sleep timer is useful when you are going to sleep while this unit is playing or recording a source. The sleep timer also automatically turns off any external components connected to the AC OUTLET(S) (page 25).

Set the operation mode selector to **AMP and then press **SLEEP** on the remote control repeatedly to set the amount of time.**

The sleep timer setting changes as shown below.

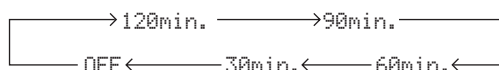

Once the sleep timer is set, the SLEEP indicator lights up in the front panel display, and the display returns to the selected sound field program.

To cancel the sleep timer

Set the operation mode selector to **AMP** and then press **SLEEP** on the remote control repeatedly to select “SLEEP OFF”.



If you set the main zone to the standby mode, the sleep timer is automatically canceled.

Sound field programs

This unit is equipped with a variety of precise digital decoders that allow you to enjoy multi-channel playback from almost any stereo or multi-channel sound source. This unit is also equipped with a Yamaha digital sound field processing (DSP) chip containing several sound field programs which you can use to enhance your playback experience.



The Yamaha CINEMA DSP sound field programs are compatible with all Dolby Digital, DTS, Dolby Surround, Dolby TrueHD and DTS-HD Master Audio sources.

Selecting sound field programs

Rotate the **PROGRAM** selector (or set the operation mode selector to **AMP** and then press one of the sound field selector buttons repeatedly).

The name of the selected sound field program appears in the front panel display and in the short message display.



- You can select the desired sound field program and setting the parameters by using the GUI menu (page 80).
- Available sound field parameters and the created sound field differ depending on the input sources and the settings of this unit.

Notes

- When you select an input source, this unit automatically selects the last sound field program used with the corresponding input source.
- Sound field programs cannot be selected when the component connected to the MULTI CH INPUT jacks is selected as the input source (page 37) or when this unit is in the PURE DIRECT mode (page 47).
- When you play back DTS 96/24 sources with any sound field program, this unit applies the selected program without activating the DTS 96/24 decoder.
- Sampling frequencies higher than 48 kHz are sampled down to 48 kHz or lower and then sound field programs are applied.

Descriptions of the characteristics of the sound field programs

Following indexes indicates the characteristics and trends of each sound field program.

Note

The characteristics of the sound field programs may differ depending on the settings of the listening room, etc.

Size of sound field space (Size)



Indicates the size of the sound field to be generated. If the value for this item is small, the sound is that of a small space, while if the value is large, the sound is that of a vast space.

Vertical/horizontal balance (V/H balance)



Indicates the balance of the vertical (height) and horizontal directions for the sound field to be generated. If this item is more in the horizontal direction, the sound is that of a space with strong reflections from the walls, while if it is more in the vertical direction, the sound is that of a space with strong reflections from the ceiling.

Front/rear balance (F/R balance)



A CINEMA DSP sound field processing expressing whether the effect is stronger towards the front or rear. When the effect is stronger towards the front, the listener senses a feeling of openness and depth towards the screen, while when the effect is stronger towards the rear, the listener gets a sense of envelopment and movement. Suits basically all types of contents for programs with a good front/rear balance, and is effective when selected appropriately for programs in which the balance is more towards either the front or rear.

Sound field atmosphere (Atmosphere)



The sound field to be generated is evaluated according to whether it is nearer to one or the other of the following; Simple: Sounds that fade straight-forwardly, with a light, gentle impression, depending on the program. This suits almost all contents relatively well, but provides little brilliance or powerfulness.

Complex: Sounds transform in complex ways as they fade out, with a rich, brilliant impression, depending on the program.

This is extremely effective for the right contents, but is suited for a smaller range of contents.



The sound field to be generated is evaluated according to whether it is nearer to one or the other of the following; Calm: An overall composed, moderate effect, stressing the overall quality of the atmosphere without aiming at any extreme effects. This suits almost all contents relatively well, but provides little showiness or powerfulness.

Powerful: Designed with specific contents in mind (expressing vast spaces, feverish excitement, etc.). This is extremely effective for the right contents, but is suited for a smaller range of contents.

■ For audio music sources



For audio music sources, we also recommend using the PURE DIRECT mode (page 47), STRAIGHT mode (page 46), or surround decode mode (page 74).

CLASSICAL

CLASSICAL	
<p>Hall in Munich</p> <p>This sound field simulates a concert hall with approximately 2500 seats in Munich, using stylish wood for the interior finishing as normal standards for European concert halls. Fine, beautiful reverberations spread richly, creating a calming atmosphere. The listener's virtual seat is at the center left of the arena.</p>	<p>Size Small Large</p> <p>V/H balance Vertical Horizontal</p> <p>Atmosphere Simple Complex</p>
<p>Hall in Vienna</p> <p>This is an approximately 1700-seated, middle-sized concert hall with a shoebox shape that is traditional in Vienna. Pillars and ornate carvings create extremely complex reflections from all around the audience, producing a very full, rich sound.</p>	<p>Size Small Large</p> <p>V/H balance Vertical Horizontal</p> <p>Atmosphere Simple Complex</p>

Hall in Amsterdam	Size Small Large
The large, shoe box shaped hall seats about 2200 around the circle stage. Reflections are rich and pleasing while the sound travels freely.	V/H balance Vertical Horizontal
	Atmosphere Simple Complex

Church in Freiburg	Size Small Large
Located in the south of Germany, this grand, stone-built church has a pointed tower at 120 meters in height. Its long and narrow shape and the high ceiling enable the elongated reverberation time and limited initial reflection time. Thus, the rich reverberation rather than the sound itself reproduces the atmosphere of the church.	V/H balance Vertical Horizontal
	Atmosphere Simple Complex

Chamber	Size Small Large
This program creates a relatively wide space with a high ceiling like an audience hall in a palace. It offers pleasant reverberations that are suitable for courtly music and chamber music.	V/H balance Vertical Horizontal
	Atmosphere Simple Complex

LIVE/CLUB
2

LIVE/CLUB

Village Vanguard	Size Small Large
The Jazz club is on 7th Avenue, New York. This small club with the low ceiling makes the powerful reflections converge toward the stage located in the corner.	V/H balance Vertical Horizontal
	Atmosphere Simple Complex

Warehouse Loft	Size Small Large
The warehouse resembles some lofts in Soho. Sound reflects off the concrete walls clearly with a lot of energy.	V/H balance Vertical Horizontal
	Atmosphere Simple Complex

Cellar Club	Size Small Large
This program simulates a live house with a low ceiling and homey atmosphere. A realistic, live sound field features powerful sound as if the listener is in a row in front of a small stage.	V/H balance Vertical Horizontal
	Atmosphere Simple Complex

The Roxy Theatre	Size Small Large
This is the sound field of a rock music live house in Los Angeles, with approximately 460 seats. The listener's virtual seat is at the center left of the hall.	V/H balance Vertical Horizontal
	Atmosphere Simple Complex

The Bottom Line	Size Small Large
This is the sound field at stage front in The Bottom Line, that was a famous New York jazz club once. The floor can seat 300 people to the left and right in a sound field offering real and vibrant sound.	V/H balance Vertical Horizontal
	Atmosphere Simple Complex

■ For various sources

ENTERTAIN
3 ENTERTAIN

Sports	Size Small Large
This program allows the listeners to enjoy stereo sport broadcasts and studio variety programs with enriched live feeling. In sports broadcasts, the voices of the commentator and sportscaster are positioned clearly on the center while the atmosphere of the stadium expands in an optimum space to offer the listeners with a feeling of presence in the stadium.	V/H balance Vertical Horizontal
	F/R balance Front Rear
	Atmosphere Calm Powerful

■ For game programs

ENTERTAIN
3 ENTERTAIN

Action Game	Size Small Large
This sound field is suitable for action games such as car racing and FPS games. It uses the reflection data that limits the effects range per channel in order to offer a powerful playing environment with a being-there feeling by enhancing various effects tones while maintaining a clear sense of directions.	V/H balance Vertical Horizontal
	F/R balance Front Rear
	Atmosphere Calm Powerful

Roleplaying Game	Size Small Large
This sound field is suitable for role-playing and adventure games. It combines the sound field effects for movies and the sound field design used with “Action Game” to represent the depth and spatial feeling of the field during play, while offering movie-like surround effects in the movie scenes in the game.	V/H balance Vertical Horizontal
	F/R balance Front Rear
	Atmosphere Calm Powerful

■ For visual sources of music

ENTERTAIN
3 ENTERTAIN

Music Video	Size Small Large
This sound field offers an image of a concert hall for live performance of pop, rock and jazz music. The listener can indulge oneself in a hot live space thanks to the presence sound field that emphasizes the vividness of vocals and solo play and the beat of rhythm instruments, and to the surround sound field that reproduces the space of a big live hall.	V/H balance Vertical Horizontal
	F/R balance Front Rear
	Atmosphere Calm Powerful

Recital/Opera	Size Small Large
This program controls the amount of reverberations at an optimum level and emphasizes the depth and clarity of human voices. “Recital/Opera” offers the reverberations of an orchestra box in front of the listener at the same time as providing the acoustic positioning and feeling of presence on the stage. The surround sound field is relatively moderate, but the data for concert hall effects are used to represent the inherent beauty of music. The listener will not be fatigued even after long hours of opera entertainment.	V/H balance Vertical Horizontal
	F/R balance Front Rear
	Atmosphere Calm Powerful

BASIC OPERATION

English

■ For movie sources



You can select the desired decoder (page 74) used with following sound field program (except “Mono Movie”).

MOVIE

<p>Standard</p> <p>This program create a sound field emphasizing the surrounding feeling without disturbing the original acoustic positioning of multi-channel audio such as Dolby Digital and DTS. It has been designed with the concept of “an ideal movie theater”, in which the audience is surrounded by beautiful reverberations from the left, right and rear.</p>	<p>Size Small Large</p> <p>V/H balance Vertical Horizontal</p> <p>F/R balance Front Rear</p> <p>Atmosphere Calm Powerful</p>
<p>Spectacle</p> <p>This program represents the spectacular feeling of large-scale movie productions. It reproduces a broad theater sound field matching the cinemascope and wider-screen movies with an excellent dynamic range from very small to extremely large sound.</p>	<p>Size Small Large</p> <p>V/H balance Vertical Horizontal</p> <p>F/R balance Front Rear</p> <p>Atmosphere Calm Powerful</p>
<p>Sci-Fi</p> <p>This program clearly reproduces the finely elaborated sound design of the latest science fiction and special effects-featuring movies. You can enjoy a variety of cinematographically created virtual spaces reproduced with clear separation between dialog, sound effects and background music.</p>	<p>Size Small Large</p> <p>V/H balance Vertical Horizontal</p> <p>F/R balance Front Rear</p> <p>Atmosphere Calm Powerful</p>
<p>Adventure</p> <p>This program is ideal for precisely reproducing the sound design of action and adventure movies. The sound field restrains reverberations but puts emphasis on reproducing a powerful space expanded widely to the left and right. The reproduced depth is also restrained relatively to ensure the separation between audio channels and the clarity of the sound.</p>	<p>Size Small Large</p> <p>V/H balance Vertical Horizontal</p> <p>F/R balance Front Rear</p> <p>Atmosphere Calm Powerful</p>
<p>Drama</p> <p>This sound field features stable reverberations that match a wide range of movie genres from serious dramas to musicals and comedies. The reverberations are modest but offer an optimum spatial feeling, reproducing effects tones and background music softly but cubically around clear words and center positioning in a way that does not fatigue the listener even after long hours of viewing.</p>	<p>Size Small Large</p> <p>V/H balance Vertical Horizontal</p> <p>F/R balance Front Rear</p> <p>Atmosphere Calm Powerful</p>
<p>Mono Movie</p> <p>This program is provided for reproducing monaural video sources such as a classic movie in an atmosphere of a good old movie theater. The program produces the optimum expansion and reverberation to the original audio to create a comfortable space with a certain sound depth.</p>	<p>Size Small Large</p> <p>V/H balance Vertical Horizontal</p> <p>F/R balance Front Rear</p> <p>Atmosphere Calm Powerful</p>

■ Stereo playback

STEREO
5 STEREO

2ch Stereo

Use this program to mix down multi-channel sources to 2 channels.

7ch Stereo

Use this program to output sound from all speakers. When you play back multi-channel sources, this unit downmixes the source to 2 channels, and then output the sound from all speakers. This program creates a larger sound field and is ideal for background music at parties, etc.

■ For compression artifacts (Compressed Music Enhancer mode)

ENHANCER
6 ENHANCER

Straight Enhancer

Use this program to improve the sound enhancer nearest to the original depth and width of the 2-channel or multi-channel compression artifacts.

7ch Enhancer

Use this program to play back compression artifacts in 7-channel stereo.

■ Surround decoder mode

SUR. DECODE
7 SUR. DECODE

Surround Decoder

Use this program to play back sources with using the desired surround decoders (page 74).

■ Using sound field programs without surround speakers (Virtual CINEMA DSP)

Virtual CINEMA DSP allows you to enjoy the CINEMA DSP sound field programs without surround speakers. It creates virtual speakers to reproduce the natural sound field.

When you set “Surround” to “None” (page 87), Virtual CINEMA DSP activates automatically whenever you select a CINEMA DSP sound field program (page 40).

Note

Virtual CINEMA DSP does not activate in the following cases:

- “MULTI CH” is selected as the input source (page 37).
- headphones are connected to the PHONES jack.
- the unit is in the “7ch Stereo” mode (page 45).

■ Enjoying multi-channel sources and sound field programs with headphones (SILENT CINEMA)

SILENT CINEMA allows you to enjoy multi-channel music or movie sound through ordinary headphones. SILENT CINEMA activates automatically whenever you connect headphones to the PHONES jack while listening to CINEMA DSP sound field programs (page 40). When activated, the SILENT CINEMA indicator lights up in the front panel display.

Note

SILENT CINEMA does not activate in the following cases:

- “MULTI CH” is selected as the input source (page 37).
- the unit is in the “2ch Stereo” (page 45), STRAIGHT (page 46) or “PURE DIRECT” (page 47) mode.

Before performing the following operation, set the operation mode selector on the remote control to **AMP**.

Using CINEMA DSP 3D mode

CINEMA DSP 3D mode creates the intensive and accurate stereoscopic sound field in the listening room. You can activate and deactivate the CINEMA DSP 3D mode.

Press **3D DSP repeatedly to turn on or off the CINEMA DSP 3D mode.**

While this unit is in the CINEMA DSP 3D mode, the 3D indicator lights up.

Note

CINEMA DSP 3D does not activate (“3D:--“ appears) in the following cases:

- the “Front Presence” setting is set to “None” (page 88).
- no CINEMA DSP is selected.
- headphones are connected to the PHONES jack.

Before performing the following operation, set the operation mode selector on the remote control to **AMP**.

Enjoying unprocessed input sources

When this unit is in the STRAIGHT mode, 2-channel stereo sources are output from only the front left and right speakers. Multi-channel sources are decoded straight into the appropriate channels without any additional effect processing.

Press **STRAIGHT (or **STRAIGHT**) to select “STRAIGHT”.**

The names of the audio signal format of the input source and the active decoder appear in the front panel display.

To deactivate the STRAIGHT mode

Press **STRAIGHT** (or **STRAIGHT**) again or select another sound field program (page 40).

Using audio features

Before performing the following operation, set the operation mode selector on the remote control to **ⓂAMP**.

Enjoying pure hi-fi sound

Use the PURE DIRECT mode to enjoy the pure fidelity sound of the selected source. When the PURE DIRECT mode is activated, this unit plays back the selected source with the least circuitry.

Press **ⓁPURE DIRECT** (or **ⓂPURE DIRECT**) to turn on or off the PURE DIRECT mode.

The **ⓁPURE DIRECT** button on the front panel lights up and the front panel display automatically turns off while this unit is in the PURE DIRECT mode.

Notes

- The following operations are not possible when this unit is in the PURE DIRECT mode:
 - switching the sound field program
 - displaying the GUI menu
- The PURE DIRECT mode is automatically canceled whenever this unit is turned off.



To make this unit output video signals during the PURE DIRECT mode, configure the “Pure Direct” setting (page 93).

Adjusting the tonal quality

Use this feature to adjust the balance of bass and treble for the front L/R and center speaker channels and the subwoofer channel.

1 Press **ⓈTONE CONTROL** on the front panel repeatedly to select the high-frequency response (TREBLE) or the low-frequency response (BASS).

2 Rotate the **ⓂPROGRAM** selector to adjust the high-frequency response (TREBLE) or the low-frequency response (BASS).

Control range: -6.0 dB to +6.0 dB

Notes

- If you increase or decrease the high-frequency or the low-frequency sound to an extreme level, the tonal quality of the surround speakers may not match that of the front L/R and center speakers and the subwoofer.
- TONE CONTROL is not effective when the PURE DIRECT mode is activated, or when “MULTI CH” is selected as the input source.

Before performing the following operation, set the operation mode selector on the remote control to **ⓂAMP**.

Adjusting the speaker level

You can adjust the output level of each speaker while listening to a music source. This is also possible when playing sources input at the MULTI CH INPUT jacks.

Note

This operation will override the level adjustments made in the automatic setup (page 30) and “Level” (page 89).

1 Press **ⓈLEVEL** and then **ⓈΔ / ▽** repeatedly to select the speaker you want to adjust.

Display	Adjusted speaker
FRONT L	Front left speaker
FRONT R	Front right speaker
CENTER	Center speaker
SUR. L	Surround left speaker
SUR. R	Surround right speaker
SB L	Surround back left speaker
SB R	Surround back right speaker
FP L	Presence left speaker
FP R	Presence right speaker
SWFR	Subwoofer



The available speaker channels differ depending on the speaker settings.

2 Press **Ⓢ◀ / ▶** on the remote control to adjust the speaker output level.

Control range: -10.0 dB to +10.0 dB

Selecting the recording source

Use this feature to select a source component from which you want to record.

1 Press and hold **ⓈREC OUT** until “REC OUT” appears in the front panel display.

2 Rotate **ⓂPROGRAM** to select the source component.



To record the input source currently selected, select “SOURCE”.

FM/AM tuning

Overview

You can use two tuning modes to tune into the desired FM/AM station:

Frequency tuning mode

You can search or specify the frequency of the desired FM/AM station automatically or manually (see “FM/AM tuning operations” on this page).

Preset tuning mode

You can preset the desired FM/AM station in advance, and then recall the station by specifying the preset group and number (see “Recalling a preset station” on page 50).

Note

Orient the connected FM and AM antennas for the best reception.

Before performing the following operations, set the operation mode selector on the remote control to **⑫SOURCE** and then press **⑬TUNER**.

FM/AM tuning operations

1 Press **⑪BAND** (or **⑧BAND**) to select the desired reception band.

2 If the PRESET indicator in the front panel lights up, press **⑭SEARCH MODE** (or **⑲SRCH MODE**) to turn it off.

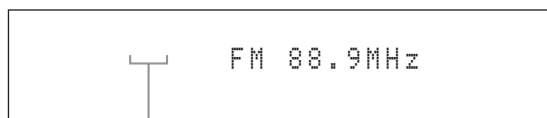

PRESET turns off

3 To search the station automatically, press and hold **ⓕPRESET/TUNING/CH </>** (or press **ⓐPRESET/CH Δ / ▽**) for about 2 seconds. To search the station manually, press **ⓕPRESET/TUNING/CH </>** repeatedly.

- To tune into a higher frequency, press **ⓕ>** (or **ⓑΔ**).
- To tune into a lower frequency, press **ⓕ<** (or **ⓑ▽**).

Note

If the signal from the station you want to select is weak, search the station manually or enter the frequency directly (page 48).



- When this unit is tuned into a station, the TUNED indicator lights up.
- To switch the information (current input source, current sound field program, etc) displayed in the front panel display, press **ⓀINFO** (or set the operation mode to **⑫AMP** and then press **⑬INFO**) repeatedly.
- To switch between stereo or monaural FM reception, press **①STEREO/MONO** (or **⑳AUDIO**).
- (U.S.A. model only)

If this unit is tuned into an HD Radio station (page 51), the HD indicator lights up in the front panel display.

Direct frequency tuning

Use this feature to tune into the desired station directly by entering the frequency.

1 Follow steps 1 and 2 in “FM/AM tuning operations” (page 48) to select the desired reception band.

2 Enter the frequency of the desired station by pressing the numeric buttons (**⑫**).

Example: To tune into 103.7 MHz



If the entered frequency is out of the range of the FM/AM tuning, “WRONG STATION!” appears in the front panel display.

Before performing the following operations, set the operation mode selector on the remote control to **SOURCE** and then press **TUNER**.

Preset FM/AM stations

Use this feature to store up to 40 stations FM/AM stations (A1 to E8: 8 preset station numbers in each of the 5 preset station groups). Preset the desired stations to this unit by using the automatic or manual station preset.

Automatic station preset

You can use the automatic preset tuning feature to store up to 40 FM stations with strong signals in order.

(U.S.A. model only)

You can use the automatic preset tuning feature to store up to 40 AM HD Radio, FM HD Radio, and analog FM radio stations with strong signals.

(U.S.A. model only)

1 Press **BAND** (or **BAND**) to select the desired reception band.

This unit searches the stations in the selected band and then another band.

2 Press and hold **BAND** (or **BAND**) for more than 3 seconds.

The MEMORY indicator flashes and “AUTO MEMORY” appears in the front panel display. After approximately 5 seconds, automatic presetting starts from the current frequency and proceeds toward higher frequencies.

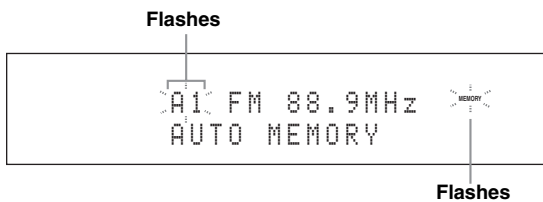

When automatic preset tuning is completed, the MEMORY indicator disappears.



- To specify the preset group and number from which this unit stores stations, press **PRESET/TUNING/CH** $\triangleleft/\triangleright$ (or **CAT./A-E** $\triangleleft/\triangleright$ and **PRESET/CH** \triangle/∇) repeatedly after you perform step 2.
- To cancel the automatic station preset, press **BAND** (or **BAND**) again.

Notes

- Any stored station data existing under a preset station number is cleared when you store a new station under the same preset station number.
- If the number of received stations does not reach 40 (E8), automatic preset tuning automatically stops after searching for all the available stations.

- (U.S.A. model only)

When this unit stores the FM HD Radio stations with this feature, this unit stores only the main audio program of the stations (HD1). When you want to store the sub-audio programs of the FM HD Radio stations, preset the stations manually.

Manual station preset

Use this feature to store the FM or AM stations manually.

(U.S.A. model only)

You can store the analog FM/AM radio stations and FM/AM HD Radio stations manually, and you can also store the sub-audio programs of FM HD Radio station.

1 Tune into a station.

See page 48 for tuning instructions.



(U.S.A. model only)

To store a sub-audio program of the HD Radio station (HD2 to HD8), press **PRG SELECT** $\triangleleft\triangleleft/\triangleright\triangleright$ repeatedly to select the desired audio program (page 51).

2 Press **MEMORY** (or **MEMORY**).

The PRESET indicator lights up in the front panel and this unit automatically selects an empty preset number.

Lights up

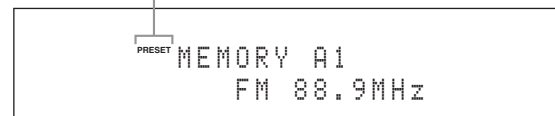

- To store the selected station under an empty preset number automatically, press and hold **MEMORY** (or **MEMORY**) for more than 2 seconds instead of step 2. In this case, the following steps are unnecessary.
- To cancel the manual station preset, press **MEMORY** (or **MEMORY**) again.

3 To select the preset group and number (A1 to E8), press **PRESET/TUNING/CH** $\triangleleft/\triangleright$ (or **CAT./A-E** $\triangleleft/\triangleright$ and **PRESET/CH** \triangle/∇) repeatedly.

- To select a higher preset station group and number, press **F** \triangleright (or **9** \triangle).
- To select a lower preset station group and number, press **F** \triangleleft (or **9** ∇).

Preset station group and number

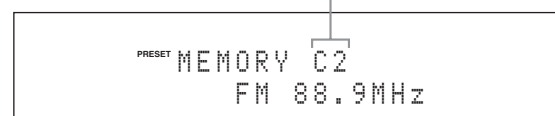



- You can also select a preset number (1 to 8) by pressing the numeric buttons (12).
- If you select a preset number being used (“*” appears next to the preset number), the current preset station will be overwritten.

4 Press ENTER (or ENTER).

The preset station is set and the PRESET indicator disappears.

Note

The reception mode (stereo or monaural) is stored along with the station frequency.

Recalling a preset station



(U.S.A. model only)

You can search for preset HD Radio stations by specifying a keyword (station name) with “Station Search” (page 86).

- 1 If the PRESET indicator in the front panel turns off, press SEARCH MODE (or SRCH MODE) to turn it on.**

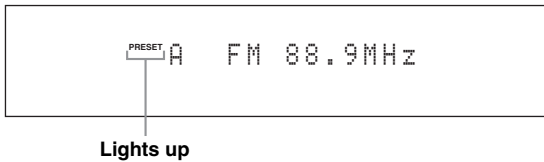

Note

You cannot enter the preset tuning mode if no preset station is set in advance.

- 2 Press PRESET/TUNING/CH \triangle/\triangleright (or PRESET/CH \triangle/∇) repeatedly to select the desired preset station group and number (A1 to E8).**

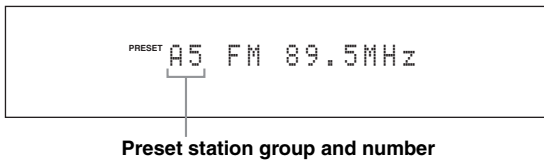

- Empty preset numbers are skipped.
- You can also select a preset station group (A to E) by pressing CAT/A-E \triangle/\triangleright and number (1 to 8) by pressing the numeric buttons (12),

Notes

- (U.S.A. model only)
When you recall one of the sub-audio program (HD2 to HD8) of an FM HD Radio station, it takes a few seconds for this unit to recall the desired program. While this unit recalls the sub-audio program, this unit outputs the sound of the analog service of the station.
- (U.S.A. model only)
If the selected sub-audio program is currently not available, this unit is tuned into the main audio program, and if the main audio program is also not available, this unit is tuned into the analog service.

Clearing preset stations

You can clear the assignments of preset stations.

- 1 Select the preset station you want to clear.**
For details, see “Recalling a preset station” (page 50).
- 2 Press and hold SEARCH MODE (or SRCH MODE) until “CLEAR?” appears in the front panel display.**

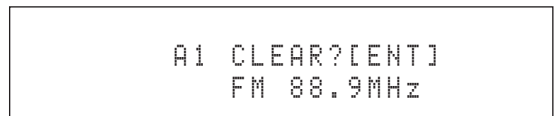

- 3 Press ENTER (or ENTER) to clear the preset station.**



To cancel the operation, press SEARCH MODE (or SRCH MODE) again.

Using HD Radio™ features (U.S.A. model only)

HD Radio technology is a new technology that enables FM and AM radio stations to broadcast programs digitally. Digital broadcasting provides listeners with radically improved audio quality and reception as well as new data services. Furthermore, supplemental program services allow listeners to select from up to 8 HD Radio programs multicast on a single FM HD Radio channel. For further information on HD Radio technology, visit “<http://www.ibequity.com/>”. This unit is equipped with an HD Radio reception feature, facilitating CD quality FM broadcasts as well as analog FM stereo quality AM broadcasts. In addition, this unit can receive both audio and data (such as song titles, artist names, program types, and comments) from supplemental program services (HD1 to HD8).

Notes

- The tuning method for HD Radio stations are same as analog FM/AM radio stations; however, you cannot tune into a hybrid HD Radio station while this unit is in the monaural tuning mode (page 48).
- This unit is capable of receiving both hybrid and all-digital HD Radio station signals. However, this unit may not automatically receive all-digital FM station signals and the automatic tuning operation may stop. In this case, enter the frequency of the desired all-digital FM HD Radio station directly by using the numeric buttons (Ⓜ) (page 48).

Before performing the following operations, set the operation mode selector on the remote control to Ⓜ **SOURCE** and then press Ⓝ **TUNER**.

Selecting HD Radio™ audio programs

Use this feature to select one of the 8 HD Radio audio programs (HD1 to HD8) when the unit is in the tuner mode. Each audio program contains data programs. When the selected FM HD Radio station provides some audio programs, currently selected audio program number appears in the front panel display as follows.

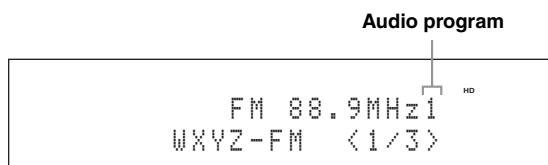

Press Ⓜ **PRG SELECT** ⏪ / ⏩ on the remote control repeatedly to toggle between HD Radio audio programs.



You can also select the desired HD Radio audio program by pressing the numeric key. While this unit is in the automatic or manual tuning mode, press a numeric button (1-8) (Ⓜ) and then Ⓝ **ENT**.

Notes

- Only 1 HD Radio audio program (HD1) is available for AM broadcasts, while up to 8 audio programs (HD1 to HD8) are available for FM broadcasts. The audio programs from HD2 to HD8 can be selected only when they contain data programs.
- When reception for an audio program ceases, the HD indicator disappears from the front panel display and HD1 is automatically selected after approximately 20 seconds.

- Some audio programs may not contain data programs depending on the broadcasting station and the time period.
- For the best reception, adjust the orientation of the antenna so that “|||.” or “||||” is displayed.

Before performing the following operations, set the operation mode selector on the remote control to Ⓜ **SOURCE** and then press Ⓝ **TUNER**.

Using the iTunes Tagging feature

This unit is equipped with the iTunes Tagging feature that enables HD Radio listeners to “tag” songs for subsequent preview and purchase on iTunes. For details on the iTunes Tagging feature, visit “<http://www.ibequity.com/>”.

1 Tune into an HD Radio station and select HD Radio audio program (if available).

If the selected station supports the iTunes Tagging feature, the TAG indicator lights up in the front panel display and “TAG” appears in the GUI screen.

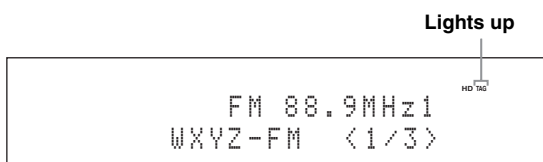

2 While a song you want to tag is being played back, press Ⓜ **TAG**.

The song is tagged and “TAG OK” appears in the front panel display and GUI screen.

Notes

- “Not Available” appears in the front panel display and GUI screen if tagging is not available.
- If a status message or an error message appears in the front panel display or in the GUI screen, see “iTunes Tagging” (page 129)



- This unit transmits the iTunes Tagging information to the iPod if an iPod that supports iTunes Tagging feature is stationed in the Yamaha iPod universal dock (YDS-11, sold separately) connected to the DOCK terminal of this unit. Otherwise, this unit stores the information in the internal memory and will transmit it next time your iPod is stationed.

Before performing the following operations, set the operation mode selector on the remote control to **AMP**.

Displaying HD Radio™ information

Use this feature to display the HD Radio information in the front panel display or in the GUI screen.



- You can configure the display settings with “Display Set” (page 98).
- To hold or release the displayed information, set the operation mode selector to **SOURCE** and then press **ENTER**. While it is held, the HOLD indicator flashes in the front panel.

Front panel display

Press **INFO** (or **INFO**) repeatedly to toggle between the following HD Radio information displays.

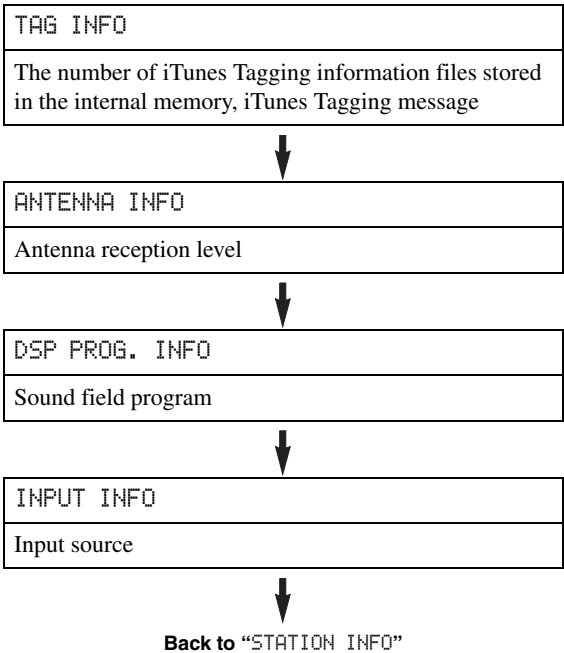
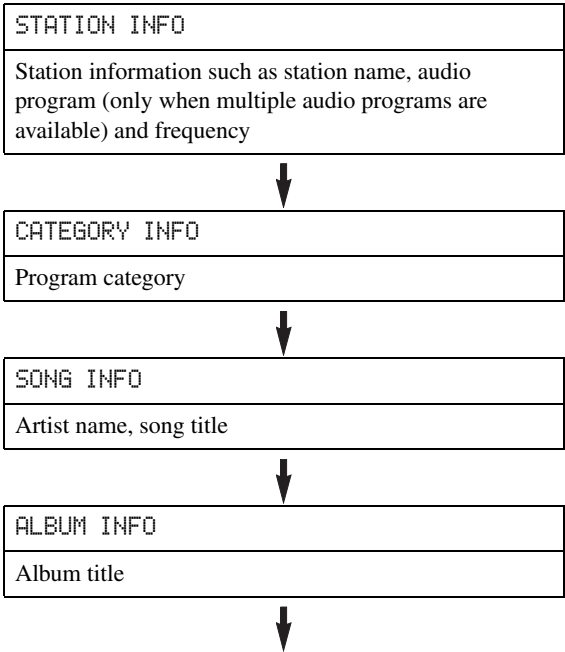

GUI screen

Press **DISPLAY** on the remote control to turn on or off the information display. The following information is displayed in the GUI screen.

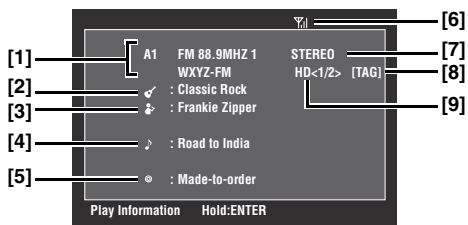

- [1] Preset station group and number, frequency, station name
- [2] Program category
- [3] Artist name
- [4] Song title
- [5] Album title
- [6] Antenna reception level
- [7] Stereo/mono
- [8] “TAG” (only when tagging is available)
- [9] Audio program number (currently selected/ total)

XM[®] Satellite Radio tuning

XM Satellite Radio offers an extraordinary variety of commercial-free music, plus the best in sports, news, talk and entertainment. XM is broadcast in superior digital audio from coast to coast. From rock to reggae, from classical to hip hop, XM has something for every music fan.

XM Satellite Radio online information

For U.S. customers: <http://www.xmradio.com/>

For Canadian customers: <http://www.xmradio.ca/>

Note

The XM Satellite Radio service is only available in the 48 contiguous United States (not available in Alaska and Hawaii) and Canada.

XM READY legal disclaimer

XM monthly service subscription sold separately. XM Mini-Tuner and Home Dock required (each sold separately) to receive XM service. It is prohibited to copy, decompile, disassemble, reverse engineer, hack, manipulate or otherwise make available any technology or software incorporated in receivers compatible with the XM Satellite Radio System. Installation costs and other fees and taxes, including a one-time activation fee may apply. All fees and programming subject to change. Channels with frequent explicit language are indicated with an XL. Channel blocking is available for XM radio receivers by calling 1-800-XMRADIO (U.S. residents) and 1-877-GETXMSR (Canadian residents). XM service only available in the 48 contiguous United States and Canada. ©2008 XM Satellite Radio Inc. All rights reserved.

■ Enjoying XM HD Surround content

This unit is equipped with the Neural-THX and Neural-THX Music decoders that play back the XM HD surround sound content of the XM Satellite Radio broadcasts in multi-channels, resulting in a full surround sound experience (page 74).

Connecting XM Mini-Tuner Home Dock

Connect XM Mini-Tuner and XM Mini-Tuner Home Dock (sold separately) to the XM jack on the rear panel of this unit. For details, see the operating instructions provided with the XM Mini-Tuner Home Dock.

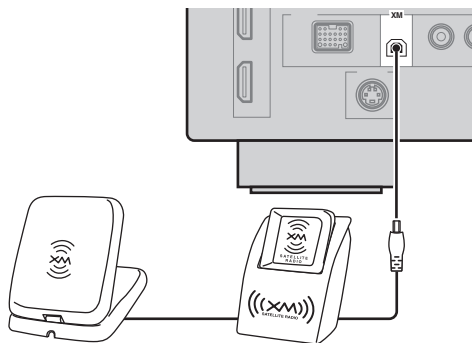

XM Mini-Tuner and XM Mini-Tuner Home Dock (sold separately)



To ensure optimal reception of the XM Satellite Radio signals, the XM Mini-Tuner Home Dock must be placed at or near a southerly facing window with no obstacles in the path to the sky. You can mount it indoors or outdoors. Use the “ANTENNA INFO” information in the front panel or in the GUI screen (page 56) to check the antenna reception level and adjust the orientation of the antenna.

Notes

- If “CHECK ANTENNA” or “CHECK XM TUNER” appears in the front panel display, the connection and setting of the antenna, XM Mini-Tuner Home Dock, or XM Mini-Tuner may not be correct.
- If “UPGRADE XM TUNER” appears in the front panel display, the connected XM Mini-Tuner is incompatible with this unit.

Activating XM Satellite Radio

Once you have installed the XM Mini-Tuner Home Dock, inserted the XM Mini-Tuner, connected the XM Mini-Tuner Home Dock to your XM Ready® home audio system, and installed the antenna, you are ready to subscribe and begin receiving XM programming. There are three places to find your eight character XM Radio ID: On the XM Mini-Tuner, on the XM Mini-Tuner package, and on XM Channel 0. Record the XM Radio ID in the following eight squares for reference.



Note

The XM Radio ID does not use the letters “I”, “O”, “S” or “F”. Activate your XM Satellite Radio service in the U.S. online at <http://activate.xmradio.com/> or call 1-800-XM-RADIO (1-800-967-2346). Activate your XM Satellite Radio service in Canada online at <https://activate.xmradio.ca/> or call 1-877-GET-XMSR (1-877-438-9677). You will need a major credit card. XM will send a signal from the satellites to activate the full channel lineup. Activation normally takes 10 to 15 minutes, but during peak busy periods you may need to keep your XM Ready home audio system on for up to an hour. When you can access the full lineup on your XM Ready home audio system you are done.

Before performing the following operations, set the operation mode selector on the remote control to **16 SOURCE**.

XM Satellite Radio operations

1 Rotate the **10 INPUT** selector (or press **3 XM**) to select “XM” as the input source.

The cursor on the left of the XM indicator lights up in the front panel display and the XM Satellite Radio information (such as channel number, channel name, category, artist name, or song title) for the currently selected channel appears in the front panel display.

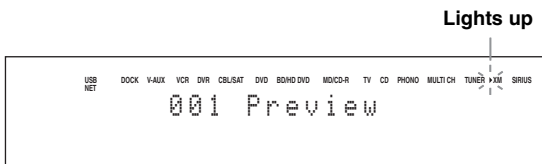

When you select “XM” as the input source, this unit automatically recalls the previously selected channel.

Notes

- The XM Satellite Radio signals cannot be output at the analog AUDIO OUT jacks.
- If a status message or an error message appears in the front panel display or in the GUI screen, see “XM Satellite Radio” (page 130)

2 Search for a channel by using one of the XM Satellite Radio search modes.

- To select a channel from the all channel list, see “All Channel Search mode” (page 54).
- To select a channel by category, see “Category Search mode” (page 54).
- To select a channel from the preset channels, see “Preset Search mode” (page 55).
- To select the desired channel directly by entering the channel number, see “Direct number access mode” (page 55).



- You can use the Neural Surround decoder to enjoy the XM HD surround sound content of the XM Satellite Radio broadcasts in multi-channels (page 74).
- You can set the XM Satellite Radio preset channels (page 55).
- You can display the XM Satellite Radio information in the front panel display or in the GUI screen (page 56).

All Channel Search mode

1 Press **10 SEARCH MODE** (or **19 SRCH MODE**) repeatedly to select “ALL CH SEARCH”.

2 Press **16 PRESET/TUNING/CH** $\triangleleft/\triangleright$ (or **19 PRESET/CH** \triangle/∇) repeatedly to search for a channel within all channels.



You can search for a channel quickly by pressing and holding **16 PRESET/TUNING/CH** $\triangleleft/\triangleright$ (or **19 PRESET/CH** \triangle/∇).

Category Search mode

1 Press **10 SEARCH MODE** (or **19 SRCH MODE**) repeatedly to select “CAT SEARCH”.

2 Press **11 CATEGORY** (or **19 A-E/CAT.** $\triangleleft/\triangleright$) repeatedly to change the channel category.

3 Press **16 PRESET/TUNING/CH** $\triangleleft/\triangleright$ (or **19 PRESET/CH** \triangle/∇) repeatedly to search for a channel within the selected channel category.



You can search for a channel quickly by pressing and holding **16 PRESET/TUNING/CH** $\triangleleft/\triangleright$ (or **19 PRESET/CH** \triangle/∇).

■ Preset Search mode

Prior to selecting a preset channel in the Preset Search mode, you must preset XM Satellite Radio channels. For details, see “Setting the XM Satellite Radio preset channels” (page 55).

- 1 Press **(H)SEARCH MODE** (or **(I)SRCH MODE**) repeatedly to select “PRESET SEARCH”.
- 2 Press **(J)CATEGORY** (or **(K)A-E/CAT.** **</>**) repeatedly to change the preset channel group (A to E).
- 3 Press **(L)PRESET/TUNING/CH** **</>** (or **(M)PRESET/CH** **Δ/∇**) repeatedly to change the preset channel number (1 to 8).



You can also select the preset channel number directly by pressing the numeric buttons (1 to 8) **(N)**.

■ Direct number access mode

- 1 Press **(I)SRCH MODE** on the remote control repeatedly to select “ALL CH SEARCH” or “CAT SEARCH”.
- 2 Press the numeric buttons **(N)** to enter the desired three-digit channel number.
For example, to enter the number 123, press the numeric buttons **(N)** as shown below.

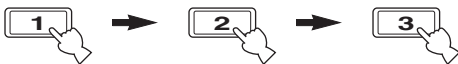

- To display the XM Radio ID number in the front panel display, select channel “0”.
- To enter a one-digit or two-digit channel number, press the numeric buttons **(N)** on the remote control and then press **(O)ENT** to confirm the input number.
- Instead of pressing **(O)ENT** to tune into the channel immediately, you can wait a few seconds until this unit confirms the entered channel number.
- Pressing a button other than the numeric buttons **(N)** or **(O)ENT** cancels the Direct Number Access mode procedure.

Before performing the following operations, set the operation mode selector on the remote control to **(P)SOURCE** and then press **(Q)XM**.

Setting the XM Satellite Radio preset channels

You can use this feature to store up to 40 XM Satellite Radio channels (A1 to E8: 8 preset channel numbers in each of the 5 preset channel groups). You can then recall any preset channel easily by selecting the preset channel group and number as described in “Preset Search mode” (page 55).

- 1 Search for a channel you want to set as a preset channel by using one of the XM Satellite Radio search modes.
For details, see “XM Satellite Radio operations” (page 54).

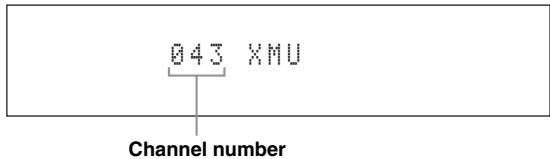

- 2 Press **(R)MEMORY** (or **(S)MEMORY**).
The PRESET indicator lights up in the front panel and this unit automatically selects an empty preset number.

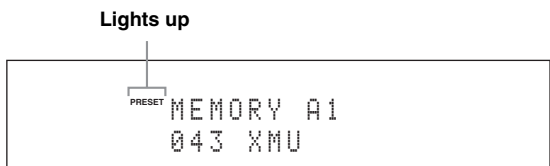

- To store the selected channel under an empty preset number automatically, press and hold **(R)MEMORY** (or **(S)MEMORY**) for more than 2 seconds instead of step 2. In this case, the following steps are unnecessary.
- To cancel the preset operation, press **(R)MEMORY** (or **(S)MEMORY**) again.

- 3 To select the preset channel group and number (A1 to E8), press **(L)PRESET/TUNING/CH** **</>** (or **(M)CAT./A-E** **</>** and **(M)PRESET/CH** **Δ/∇**) repeatedly.
 - To select a higher preset channel group and number, press **(L)>** (or **(M)Δ**).
 - To select a lower preset channel group and number, press **(L)<** (or **(M)∇**).



- You can also select a preset number (1 to 8) by pressing the numeric buttons (12).
- If you select a preset number being used (“*” appears next to the preset number), the current preset channel will be overwritten.

4 Press (ENTER) (or (ENTER)).

The preset channel is set and the PRESET indicator disappears.

■ Clearing preset channels

You can clear the assignments of preset XM Satellite Radio channels.

1 Select the preset XM Satellite Radio channel to clear.

For details, see “Preset Search mode” (page 55).

2 Press and hold (H)SEARCH MODE (or (SRCH MODE)) until “CLEAR?” appears in the front panel display.

3 Press (ENTER) (or (ENTER)) to clear the preset channel.

To cancel the operation, press (H)SEARCH MODE (or (SRCH MODE)).

Before performing the following operations, set the operation mode selector on the remote control to (AMP).

Displaying the XM Satellite Radio information

Use this feature to display the XM Satellite Radio information in the front panel display or in the GUI screen.



- You can configure the display settings with “Display Set” (page 98).
- You can hold or release the displayed information by pressing (ENTER). While it is held, the HOLD indicator flashes in the front panel.

Notes

- If a status message or an error message appears in the front panel display or GUI screen, see “XM Satellite Radio” (page 130).
- The current XM Satellite Radio reception level appears on the top of the XM Satellite Radio information screen. For the best reception, adjust the orientation of the antenna of Home Dock so that “|||.” or “||||” is displayed here. “....” is displayed if the antenna cannot receive the signals correctly. In this case, adjust the orientation of the antenna (page 53).

■ Front panel display

Press (INFO) (or (INFO)) repeatedly to toggle between the following XM Satellite Radio information display modes.

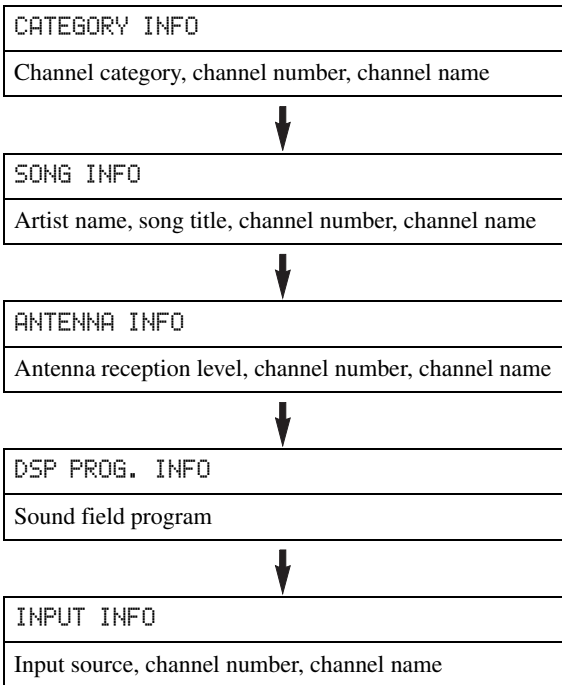



Back to "CATEGORY INFO"



- If the XM Satellite Radio information contains a character that cannot be recognized by this unit, the character will be displayed with a space.
- When the antenna of the XM Mini-Tuner Home Dock cannot receive the signals, "NO SIGNAL" appears in the front panel display.

■ GUI screen

Press **Ⓜ** **DISPLAY** on the remote control to turn on or off the information display.

The following information is displayed in the GUI screen.

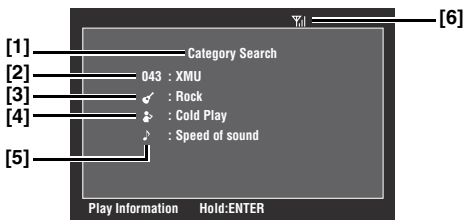

[1] Search mode (page 54)

[2] Channel number, channel name

[3] Channel category

[4] Artist name

[5] Song title

[6] Antenna reception level

SIRIUS Satellite Radio™ tuning

SIRIUS Satellite Radio provides over 130 channels of exclusive entertainment and 100% commercial-free music. Only SIRIUS has more than 65 original music channels, from today's hits to R&B, oldies, and classical masterpieces. From authentic country and real bluegrass to cool jazz, hot latin, reggae, rock and many more. Best of all, it's all 100% commercial-free.

SIRIUS also has more than 55 channels of world-class sports, news and entertainment. Included as part of your subscription, you get up to 16 NFL games a week, up to 40 NBA games a week and up to 40 NHL games a week. (Games are broadcast during their respective seasons.)

Coupled with great sports news from ESPN, the SIRIUS sports offering is unrivaled. And don't forget a host of other great news and entertainment, like NPR, CNBC, Fox News, Radio Disney and E! Entertainment Radio. For more information, visit <http://www.sirius.com/>.

SIRIUS Satellite Radio legal disclaimer

SIRIUS is available in the U.S.A. for subscribers with addresses in the continental U.S.A. and is available in Canada for subscribers with a Canadian address. To Get SIRIUS Satellite Radio a subscription and compatible tuner and antenna are required and sold separately. Visit sirius.com for the most complete and up-to-date channel lineup and information.

"SIRIUS" and the SIRIUS dog logo and related marks are trademarks of SIRIUS Satellite Radio Inc.

Connecting the SiriusConnect™ tuner

Connect the SiriusConnect tuner (sold separately) to the SIRIUS jack on the rear panel of this unit. For details, see the operating instructions provided with the SiriusConnect tuner.

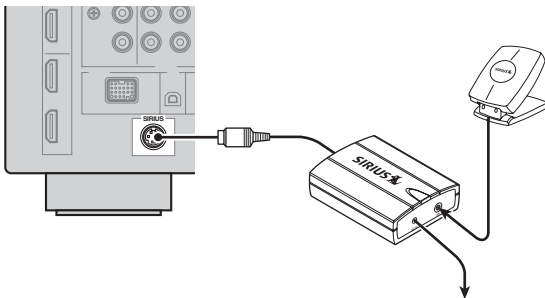

- To ensure optimal reception of the SIRIUS Satellite Radio signals, the antenna of the SiriusConnect tuner must be placed at or near a window with no obstacles in the path to the sky. The orientation of the antenna for the best reception differs depending on the area. Refer to the instruction manuals supplied with the SiriusConnect tuner for the installation of the antenna. You can mount it indoors or outdoors.
- Use the "ANTENNA INFO" information in the front panel or in the GUI screen (page 63) to check the antenna reception level and adjust the orientation of the antenna.
- You need to connect the SiriusConnect tuner to the AC wall outlet.

Notes

- If "CHECK SR TUNER" or "ANTENNA ERROR" appears in the front panel display, the connection of the SiriusConnect tuner or antenna is incorrect. In such cases, check the connection of the SiriusConnect tuner and the antenna.
- If "NOT SUPPORTED" appears in the front panel display, this unit does not support the connected SiriusConnect tuner.

Activating SIRIUS Satellite Radio™ subscription

Before using the SIRIUS Satellite Radio feature, you need to activate your SIRIUS Satellite Radio subscription. To activate the subscription you need the Sirius ID which is uniquely assigned to the SiriusConnect tuner. Sirius ID is 12-digit number and it appears on the package of the SiriusConnect tuner, on the label of the SiriusConnect tuner, and when you tune into the SIRIUS Satellite Radio channel “0” (see below).

■ Displaying the Sirius ID of your SiriusConnect tuner

1 Set the operation mode selector on the remote control to **16 SOURCE** and then press **3 SIRIUS**.

2 Press **12 0** and then **24 ENT** to display the Sirius ID of your SiriusConnect tuner.

“000 Sirius IDxxxxxxxxxx” (“xxxxxxxxxx” indicates the 12-digit Sirius ID of your SiriusConnect tuner) appears in the front panel display.

Write the Sirius ID below.

ID: _____

3 Contact SIRIUS Satellite Radio to activate your subscription.

SIRIUS Satellite Radio online information

Contact for activation

URL: <https://activate.siriusradio.com/>

Phone: 1-888-539-SIRIUS (1-888-539-7474)



Status messages appear in the front panel display or GUI screen during the activation. For details, see “SIRIUS Satellite Radio” (page 131). Once the activation is finished, “SUB UPDATED” appears.

Before performing the following operations, set the operation mode selector on the remote control to **16 SOURCE**.

SIRIUS Satellite Radio™ operations

1 Rotate the **INPUT** selector (or press **3 SIRIUS**) to select “SIRIUS” as the input source.

The cursor on the left of the SIRIUS indicator lights up in the front panel display and the SIRIUS Satellite Radio information (such as channel number, channel name, category, artist name, or song title) for the currently selected channel appears in the front panel display.

Lights up

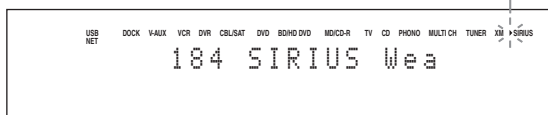

When you select “SIRIUS” as the input source, this unit automatically recalls the previously selected channel.

Notes

- The SIRIUS Satellite Radio signals cannot be output at the analog AUDIO OUT jacks.
- When you have not activated your subscription yet, you can only select channel “184” or “000”.
- If a status message or an error message appears in the front panel display or in the GUI screen, see “SIRIUS Satellite Radio” (page 131).

2 Search for a channel by using one of the SIRIUS Satellite Radio search modes.

- To select a channel from the all channel list, see “All Channel Search mode” (page 60).
- To select a channel by category, see “Category Search mode” (page 60).
- To select a channel from the preset channels, see “Preset Search mode” (page 60).
- To select the desired channel directly by entering the channel number, see “Direct number access mode” (page 60).



- If you tune into a channel that you do not subscribe, “CALL 888-539-SIRIUS TO SUBSCRIBE” appears in the front panel display.
- You can set the SIRIUS Satellite Radio preset channels (page 61).
- You can display the SIRIUS Satellite Radio information in the front panel display or in the GUI screen (page 63).

■ All Channel Search mode

1 Press **Ⓜ** **SEARCH MODE** (or **Ⓜ** **SRCH MODE**) repeatedly to select “ALL CH SEARCH”.

2 Press **Ⓟ** **PRESET/TUNING/CH** **◀/▶** (or **Ⓟ** **PRESET/CH** **△/▽**) repeatedly to search for a channel within all channels.



- You can search for a channel quickly by pressing and holding **Ⓟ** **PRESET/TUNING/CH** **◀/▶** (or **Ⓟ** **PRESET/CH** **△/▽**).
- You can skip channels to the previous or next category by pressing **Ⓜ** **CATEGORY** (or **Ⓟ** **A-E/CAT.** **◀/▶**).

■ Category Search mode

1 Press **Ⓜ** **SEARCH MODE** (or **Ⓜ** **SRCH MODE**) repeatedly to select “CAT SEARCH”.

2 Press **Ⓜ** **CATEGORY** (or **Ⓟ** **A-E/CAT.** **◀/▶**) repeatedly to change the channel category.

3 Press **Ⓟ** **PRESET/TUNING/CH** **◀/▶** (or **Ⓟ** **PRESET/CH** **△/▽**) repeatedly to search for a channel within the selected channel category.



You can search for a channel quickly by pressing and holding **Ⓟ** **PRESET/TUNING/CH** **◀/▶** (or **Ⓟ** **PRESET/CH** **△/▽**).

Note

This unit skips the channels when this unit is in the All Channel Search mode or Category Search mode in the following cases (it is not malfunction of this unit):

- the channel is locked (page 62).
- the channel is out of service.
- you do not subscribe to the channel.

■ Preset Search mode

Prior to selecting a preset channel in the Preset Search mode, you must preset SIRIUS channels. For details, see “Setting the SIRIUS Satellite Radio™ preset channels” (page 61).

1 Press **Ⓜ** **SEARCH MODE** (or **Ⓜ** **SRCH MODE**) repeatedly to select “PRESET SEARCH”.

2 Press **Ⓜ** **CATEGORY** (or **Ⓟ** **A-E/CAT.** **◀/▶**) repeatedly to change the preset channel group (A to E).

3 Press **Ⓟ** **PRESET/TUNING/CH** **◀/▶** (or **Ⓟ** **PRESET/CH** **△/▽**) repeatedly to change the preset channel number (1 to 8).



You can also select the preset channel number directly by pressing the numeric buttons (1 to 8) **Ⓜ**.

■ Direct number access mode

1 Press **Ⓜ** **SRCH MODE** on the remote control repeatedly to select “ALL CH SEARCH” or “CAT SEARCH”.

2 Press the numeric buttons **Ⓜ** to enter the desired three-digit channel number.

For example, to enter the number 123, press the numeric buttons **Ⓜ** as shown below.



- To display the Sirius ID number displayed in the front panel display, select channel “0”.
- To enter a one-digit or two-digit channel number, press the numeric buttons **Ⓜ** on the remote control and then press **Ⓜ** **ENT** to confirm the input number.
- Instead of pressing **Ⓜ** **ENT** to tune into the channel immediately, you can wait a few seconds until this unit confirms the entered channel number.
- If no button is pressed within a few seconds after you enter a one-digit or two-digit number, this unit automatically confirms the entered channel number.
- If the selected channel is locked, “PIN:_____” appears in the front panel display. Enter the four-digit Parental Lock code number by using the numeric buttons **Ⓜ** or press **Ⓜ** **ENT** to cancel (page 62).

Before performing the following operations, set the operation mode selector on the remote control to **⑩ SOURCE** and then press **③ SIRIUS**.

Setting the SIRIUS Satellite Radio™ preset channels

You can use this feature to store up to 40 SIRIUS Satellite Radio channels (A1 to E8: 8 preset channel numbers in each of the 5 preset channel groups). You can then recall any preset channel easily by selecting the preset channel group and number as described in “Preset Search mode” (page 60).

1 Search for a channel you want to set as a preset channel by using one of the SIRIUS Satellite Radio search modes.

For details, see “SIRIUS Satellite Radio™ operations” (page 59).

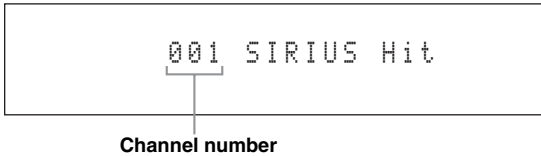

2 Press **Ⓞ MEMORY** (or **⑩ MEMORY**).

The PRESET indicator lights up in the front panel and this unit automatically selects an empty preset number.

Lights up

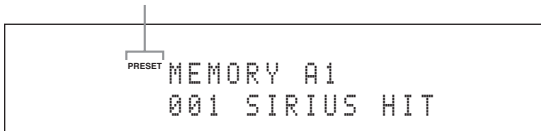

- To store the selected channel under an empty preset number automatically, press and hold **Ⓞ MEMORY** (or **⑩ MEMORY**) for more than 2 seconds instead of step 2. In this case, the following steps are unnecessary.
- To cancel the preset operation, press **Ⓞ MEMORY** (or **⑩ MEMORY**) again.

3 To select the preset channel group and number (A1 to E8), press **Ⓞ PRESET/TUNING/CH** **◀/▶** (or **⑨ CAT./A-E** **◀/▶**) and **⑨ PRESET/CH** **▲/▼** repeatedly.

- To select a higher preset channel group and number, press **Ⓞ▶** (or **⑨▲**).
- To select a lower preset channel group and number, press **Ⓞ◀** (or **⑨▼**).



- You can also select a preset number (1 to 8) by pressing the numeric buttons (**⑫**).
- If you select a preset number being used (“*” appears next to the preset number), the current preset channel will be overwritten.

4 Press **Ⓞ ENTER** (or **⑨ ENTER**).

The preset channel is set and the PRESET indicator disappears.

■ Clearing preset channels

You can clear the assignments of preset SIRIUS Satellite Radio channels.

1 Select the preset SIRIUS Satellite Radio channel to clear.

For details, see “Preset Search mode” (page 60).

2 Press and hold **Ⓞ SEARCH MODE** (or **⑲ SRCH MODE**) until “CLEAR?” appears in the front panel display.

3 Press **Ⓞ ENTER** (or **⑨ ENTER**) to clear the preset channel.

To cancel the operation, press **Ⓞ SEARCH MODE** (or **⑲ SRCH MODE**).

Setting the Parental Lock

You can use the Parental Lock feature to limit the access to the desired SIRIUS Satellite channels. This unit automatically skips the locked channels when this unit is in the All Channel Search mode or Category Search mode and you search a channel by pressing **PRESET/TUNING/CH** $\triangleleft/\triangleright$ (or **PRESET/CH** \triangle/∇).

■ Setting the code number and the locking channels

Use this feature to set the Parental Lock code number (PIN) and select the channels to be locked.

- 1 Set the operation mode selector to **AMP** on the remote control and then press **MENU** to display the GUI menu.



If the menu directory other than “Top Menu” (page 79) is displayed, press and hold **MENU** to display the top GUI menu.

- 2 Press **△/▽** repeatedly to select “Input Select” and then press **▷**.

- 3 Press **△/▽** repeatedly to select the SIRIUS Satellite Radio icon and then press **SUBMENU**.

- 4 Press **▽** to select “Parental Lock” and then **ENTER**.

The following screen appears.

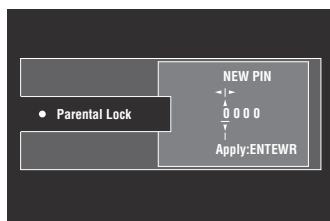

If the Parental Lock code number is already set, “PIN ----” appears instead of “NEW PIN 0000”.

- 5 Use **△/▽/◀/▶** to enter the desired 4-digit code number.

- To select a number, press **△/▽**.
- To move the digit position, press **◀/▶**.



If the Parental Lock code number is already set, enter it.

- 6 Press **ENTER** to confirm the code number. The SIRIUS Satellite Radio channel list screen appears.

- 7 Press **△/▽** repeatedly to select the desired channel category and then press **ENTER**. The SIRIUS Satellite Radio channel list screen appears.

Note

In the SIRIUS Satellite Radio channel list screen, this unit outputs the sound of the selected channel even if the channel is locked.

- 8 Press **△/▽** repeatedly to select the channel you want to lock and then press **ENTER**.

Check mark appears before the locked channel.



When you select the locked channel and press **ENTER**, this unit unlocks the selected channel.

- 9 Repeat steps 7 and 8 to lock or unlock another channel.



To switch between the category list screen and channel list screen, press **△/▽/◀/▶** to select “CAT” or “CHAN” and then press **ENTER**.

- 10 Press **△/▽/◀/▶** to select “EXIT” and then press **ENTER**.

- 11 Press **MENU** to turn off the GUI menu.

This unit is tuned into the last channel you select in the “Parental Lock” screen. If the channel is locked, this unit is tuned into “184 SIRIUS Weather & Emergency” or “000 Sirius ID”.



- If you forget or want to change the Parental lock code number, use “SIRIUS PIN” (page 122) to reset the Parental Lock code number.
- Selecting “ALL” in “INITIALIZE” (page 122) will cancel all parental locks.

■ Tuning into the locked channels

You can tune into the locked channels by the Direct number access mode or preset tuning mode. When you tune into the locked channel, following message appears in the front panel display. Enter the code number you set for the Parental Lock feature by using the numeric buttons (**12**) or press **ENT** to cancel the tuning.

Channel number

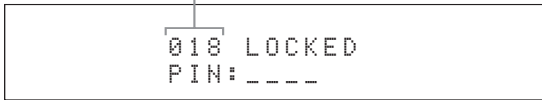

Note

If the entered code number is incorrect, “Wrong” appears in the front panel display and this unit is tuned into the previously selected channel.

Before performing the following operations, set the operation mode selector on the remote control to **AMP**.

Displaying the SIRIUS Satellite Radio™ information

Use this feature to display the SIRIUS Satellite Radio information in the front panel display or in the GUI screen.



- You can configure the display settings with “Display Set” (page 98).
- You can hold or release the displayed information by pressing **ENTER**. While it is held, the HOLD indicator flashes in the front panel.

Note

If a status message or an error message appears in the front panel display or GUI screen, see “SIRIUS Satellite Radio” (page 131).

Front panel display

Press **INFO** (or **INFO**) repeatedly to toggle between the following SIRIUS Satellite Radio information display modes.

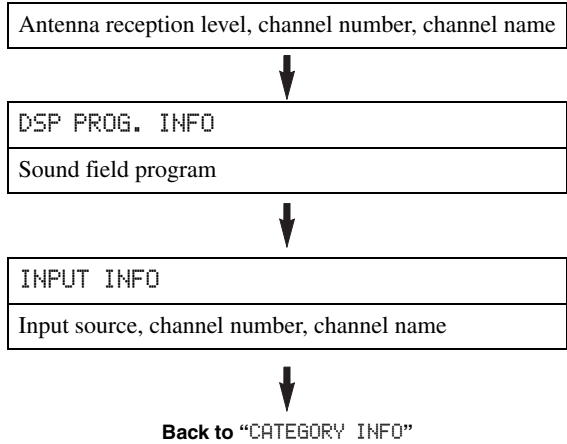
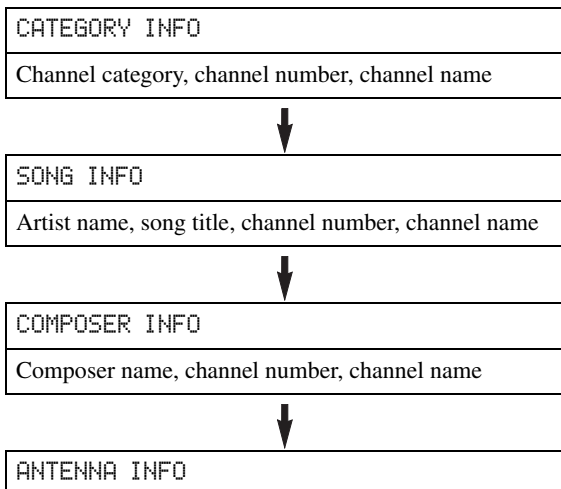

- If the SIRIUS Satellite Radio information contains a character that cannot be recognized by this unit, the character will be displayed with a space.
- When the antenna of the SiriusConnect tuner cannot receive the signals, “ACQUIRING” appears in the front panel display.
- When an information is unavailable, “----” appears.

GUI screen

Press **DISPLAY** on the remote control to turn on or off the information display.

The following information is displayed in the GUI screen.

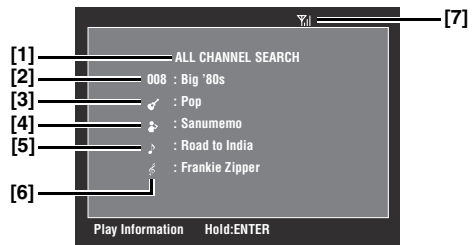

- [1] Search mode (page 59)
- [2] Channel number/name
- [3] Channel category
- [4] Artist name
- [5] Song title
- [6] Composer name
- [7] Antenna reception level

Using Bluetooth™ components

You can connect a Yamaha Bluetooth wireless audio receiver (such as YBA-10, sold separately) to the DOCK terminal of this unit and enjoy the music contents stored in your Bluetooth component (such as a portable music player) without wiring between this unit and the Bluetooth component. You need to perform “pairing” the connected Bluetooth receiver and your Bluetooth component in advance.

For details about status messages displayed in the front panel display and in the GUI screen, see “Bluetooth” (page 135).

Note

This unit supports A2DP (Advanced Audio Distribution Profile) Bluetooth profile.

Pairing the Bluetooth™ receiver and your Bluetooth component

Pairing must be performed when using a Bluetooth component with the Bluetooth receiver connected to this unit for the first time or if the pairing data has been deleted. “Pairing” refers to the operation of registering a Bluetooth component for Bluetooth communications.



- You need the pairing operation only for the first time when you use the Bluetooth component with the Bluetooth receiver.
- Pairing requires operations on this unit and on the other component with which Bluetooth communications are to be established. If necessary, refer to the other component’s operating instructions.

There are two pairing methods: pairing by using “Pairing” in the GUI menu and quick pairing.

■ Pairing by using the GUI menu

Use this feature to perform pairing with the GUI screen. For details, see “Pairing” (page 86).

■ Quick pairing

To ensure security, a time limit of 8 minutes is set for the pairing operation. You are recommended to read and fully understand all the instructions before starting.

1 Rotate the **Ⓒ INPUT selector (or set the operation mode selector to **Ⓔ** SOURCE and then press **Ⓕ** DOCK) to select “DOCK” as the input source.**

2 Turn on your Bluetooth component and then set the Bluetooth component to the pairing mode.

For details about how to operate the Bluetooth component, refer to the manual for it.

3 Press and hold **Ⓔ ENTER (or **Ⓕ** ENTER) until “Searching” appears in the front panel display.**

While the Bluetooth receiver is in the pairing mode, DOCK indicator flashes in the front panel display.



To cancel the pairing, press **Ⓔ** ENTER (or **Ⓕ** ENTER) again.

4 Check that the Bluetooth component detects the Bluetooth receiver.

If the Bluetooth component detects the Bluetooth receiver, “YBA-10 YAMAHA” (example) appears in the Bluetooth device list.

5 Select the Bluetooth receiver in the Bluetooth device list and then enter the pass key “0000” on the Bluetooth component.

When the pairing procedure is successful, “Completed” appears in the front panel display.

Note

The Yamaha Bluetooth receiver can be paired with up to eight Bluetooth components. When pairing is conducted successfully with a ninth component and the pairing data is registered, the pairing data for the least recently used other component is cleared.

Playback of the Bluetooth™ component

1 Rotate the **Ⓒ INPUT selector (or set the operation mode selector to **Ⓔ** SOURCE and then press **Ⓕ** DOCK) to select “DOCK” as the input source.**

2 Start playback of your Bluetooth component.

When the connected Bluetooth receiver detects the Bluetooth component, “BT Connected” appears in the front panel display.



- When you press **Ⓔ** ENTER on the remote control, the connected Bluetooth receiver searches and connect to the last connected Bluetooth component. If the Bluetooth receiver cannot find the Bluetooth component, “Not found” appears in the front panel display.
- To disconnect the Bluetooth receiver from the Bluetooth component, press **Ⓔ** ENTER.

Music Content menu

In “Music Content” menu of the GUI menu, you can browse the music contents of iPod, USB component, PC/MusicCAST, Internet radio, and Rhapsody® (U.S.A. model only). You can also use the playback control feature or configure the playback style setting for the selected sub input source.

Music Content menu operations

- 1 Set the operation mode selector to **AMP** on the remote control and then press **MENU** to display the GUI menu.



If the menu directory other than “Top Menu” (page 79) is displayed, press and hold **MENU** to display the top GUI menu.

- 2 Press **▲ / ▼** repeatedly to select “Music Content” and then press **▶**.

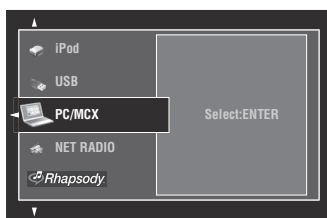

- 3 Press **▲ / ▼** repeatedly to select the desired sub input source and then press **ENTER**.

The menu of the selected sub input source appears in the GUI screen. The following screen shows the iPod menu for example.

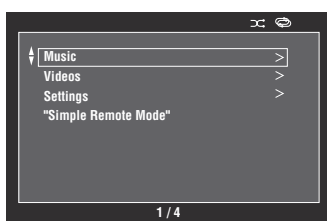

Note

If the selected sub input source is not available, “Not Available” appears.

- 4 Navigate the menu of the selected sub input source.

For details about the menu items and operation procedure for each sub input source, see the following pages.

- iPod (page 66)
- USB (page 68)
- PC/MCX (page 68)
- NET RADIO (page 68)
- Rhapsody (page 68)

- 5 Press **MENU** to turn off the GUI menu.

Using iPod™

Once you have stationed your iPod in a Yamaha iPod universal dock (such as YDS-11, sold separately) connected to the DOCK terminal of this unit (page 22), you can enjoy playback of your iPod using the supplied remote control. You can also use the Compressed Music Enhancer mode of this unit to enhance the sound quality of the compression artifacts (such as the MP3 format) stored on your iPod (page 45).

Notes

- This unit supports iPod touch, iPod (Click Wheel, including iPod classic), iPod nano and iPod mini.
- Some features may not be compatible depending on the model or the software version of your iPod.
- Some features may not be compatible depending on the model of your Yamaha iPod universal dock. The following description is based on using YDS-11.



- Once the connection between your iPod and this unit is complete, “iPod Connected” appears in the front panel display.
- For details about status messages displayed in the front panel display and in the GUI screen, see “iPod” (page 135).
- You can select whether or not this unit charges the battery of the stationed iPod when this unit is in the standby mode by configuring the “Standby Charge” setting (page 99).

iPod menu tree

The following diagram shows the construction of the iPod menu. For information on how to display the iPod menu, see “Music Content menu operations” (page 65).



Note

- * “Videos” does not appear unless your iPod and Yamaha iPod universal dock support the video browsing feature. Also, the folder structure under “Videos” varies depending on the video contents stored on your iPod.

Controlling iPod™

You control your iPod with the following remote control buttons.

■ GUI menu operation

To navigate the iPod menu using the GUI screen, set the operation mode selector to **ⓂAMP**.

Button	Function
Ⓜ ENTER	Subsequent menu/Play
△	Menu up
▽	Menu down
◀	Previous menu
▶	Subsequent menu
Ⓜ SUBMENU	Turns on/off the submenu when the play information screen is displayed
Ⓜ MENU	Turns on/off the GUI menu when the play information screen is not displayed
Ⓜ DISPLAY	Turns on/off the play information screen

Note

You can control your iPod by using the zone OSD. However, the design and available functions may be different from the iPod menu displayed in the GUI screen in the main zone.

■ Playback control operation

To operate your iPod using the following remote control buttons, set the operation mode selector to **Ⓜ SOURCE** and then press **Ⓜ DOCK**.

Button	Function
Ⓜ ◀◀	Search backward (Press and hold)
Ⓜ ▶▶	Search forward (Press and hold)
Ⓜ ▶▶▶	Skip forward
Ⓜ ◀◀◀	Skip backward
Ⓜ □	Stop
Ⓜ 	Pause
Ⓜ ▶	Play

■ Playback style settings

To change the following playback style settings, select “Settings” in the iPod menu.

Repeat (Repeat)

Use this feature to set this unit to repeat one song or a sequence of songs.

Choices: Off, One, All

- Select “Off” to deactivate this feature.
- Select “One” to set this unit to repeat one song.
- Select “All” to set this unit to repeat a sequence of songs.

Shuffle (Shuffle)

Use this feature to set this unit to play songs or albums in random order.

Choices: Off, Songs, Albums

- Select “Off” to deactivate this feature.
- Select “Songs” to set this unit to play songs in random order.
- Select “Albums” to set this unit to play albums in random order.



- To toggle between setting parameters, press **Ⓜ ENTER** repeatedly.
- When “Repeat” is set to “One” or “All”, “☺” or “☹” appears in the GUI screen.
- When “Shuffle” is on, “☺” appears in the GUI screen.

■ Simple Remote Mode

If you select “Simple Remote Mode” in the iPod menu, this unit turns off the GUI screen and allows you to operate your iPod with the remote control of this unit or controls on your iPod.



You can also select the Simple Remote Mode by holding down **Ⓜ DISPLAY** for 3 seconds when the operation mode selector is set to **Ⓜ AMP**.

■ Play information screen

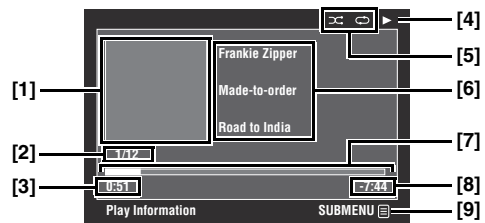

[1] Album art (if available)

[2] Track number/total tracks

[3] Elapsed time

[4] ▶ (playback), || (pausing), ▶▶ (search forward) or ◀◀ (search backward)

[5] Shuffle and repeat icons

[6] Artist name, album title, song title

[7] Progress bar

[8] Remaining time

[9] Submenu icon

Submenu items

Play Control (Playback control)

Select the desired playback control item and then press (or press and hold) **Ⓜ ENTER** to control your iPod.

Play Style (Playback style)

Select the desired playback style setting and then press **Ⓜ ENTER** repeatedly to toggle between setting parameters. For details on the playback style settings, see “Playback style settings” (page 67).

Using USB and network features

This unit is equipped with USB and network features that allow you to enjoy WAV (PCM format only), MP3, MPEG-4 AAC, and WMA files saved on your USB storage device, USB portable audio player, PC and Yamaha MCX-2000 or access the Internet Radio. You can also access the Rhapsody® streaming service (U.S.A. model only).

Notes

- Yamaha MCX-2000 may not be for sale in some locations.
- For further details about networking, refer to the operation manuals supplied with your network devices. Also refer to technical reference books, if needed.
- Some WAV, MP3, MPEG-4 AAC, and WMA files may not be playable or may be noisy when played.



For details about status messages displayed in the front panel display and in the GUI screen, see “USB and Network” (page 133).

USB and network menu tree

The following diagram shows the construction of the USB, PC/MCX, NET RADIO and Rhapsody menus. For information on how to display these menus, see “Music Content menu operations” (page 65).

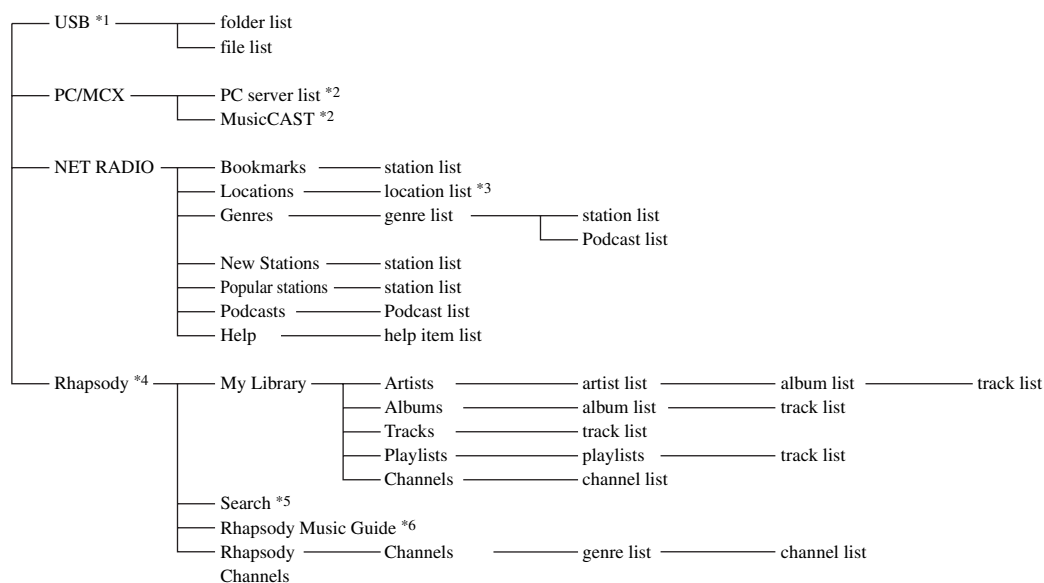

Notes

- *1 The directory hierarchy of the USB menu varies depending on the folder structure of the connected USB component.
- *2 Only the available PC servers and MCX-2000 are displayed.
- *3 The folder structure under the location list varies depending on your region.
- *4 The account setup screen appears if you have not entered your account information yet. For details, see “Account setup for Rhapsody®” (page 71).
- *5 You can search contents by keyword.
- *6 You can search contents by category provided by Rhapsody®.

Navigating USB and network menus

You can navigate the USB and network menus with the following remote control buttons.

GUI menu operation

To navigate the USB and network menus using the GUI screen, set the operation mode selector to **AMP**.

Button	Function
ENTER	Subsequent menu/Play
△	Menu up
▽	Menu down
◀	Previous menu
▶	Subsequent menu
SUBMENU	Turns on/off the submenu when any submenu items are available (submenu icon appears on the bottom right corner of the GUI menu screen)
MENU	Turns on/off the GUI menu when the play information screen is not displayed
DISPLAY	Turns on/off the play information screen

Note

You can navigate the USB and network menus by using the zone OSD. However, the design and available functions may be different from the menus displayed in the GUI screen in the main zone.

Playback control operation

To operate your USB or network component using the following remote control buttons, set the operation mode selector to **SOURCE** and then press **USB/NET**.

Button	Function
SKIP FORWARD	Skip forward (except "NET RADIO")
SKIP BACKWARD	Skip backward (except "NET RADIO")
STOP	Stop
PAUSE/PLAY	Pause/Play ("Rhapsody" only)
PLAY	Play (Menu browse mode) Play/Pause (Simple remote mode)

Notes

- Some button operations do not work depending on the selected sub input source.
- (U.S.A. model only)
 - SKIP BACKWARD** and **SKIP FORWARD** do not work during Rhapsody channel playback. **SKIP FORWARD** works up to 30 times every 3 hours.

Play information screen

The following screen shows the play information screen displayed for USB content playback for example. Available information and functions vary depending on the selected sub input source.

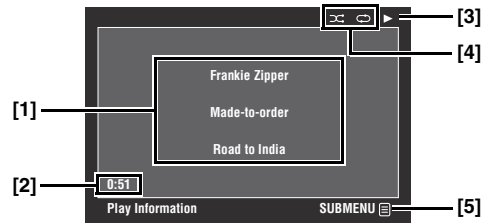

[1] Artist name, album title, song title

[2] Elapsed time

[3] ▶ (playback)

[4] Shuffle and repeat icons

[5] Submenu icon

Submenu items

Play Control (Playback control)

Select the desired playback control item and then press (or press and hold) **ENTER** to control the playback.

Play Style (Playback style)

Select the desired playback style setting and then press **ENTER** repeatedly to toggle between setting parameters. For details on the playback style settings, see "Playback style settings" (page 67).



To turn on the shuffle feature, set "Shuffle" to "On".

Using a USB storage device or a USB portable audio player

Use this feature to enjoy WAV (PCM format only), MP3, WMA and MPEG-4 AAC files saved on your USB storage device or USB portable audio player connected to the USB port on the front panel of this unit.

Notes

- This unit supports USB mass storage class devices (FAT 16 or FAT 32 format) or USB MTP devices.
- Only the first partition is displayed in the GUI menu. You cannot select files in other partitions.
- Up to 8 levels of directory hierarchy and 500 music files per directory are recognized.
- Some devices may not work properly even if they meet the requirements.
- Some WAV, MP3, WMA and MPEG-4 AAC files may not be playable or may be noisy when played.
- When you connect your USB storage device or USB portable audio player, there may be an about 10 seconds delay.

Using a PC server or Yamaha MCX-2000

Use this feature to enjoy music files saved on your PC or Yamaha MCX-2000. MCX-2000 is a music server that enhances the concept of Yamaha exclusive MusicCAST, a digital music delivery method over a personal network.

1 Install Windows Media Player 11 on your PC, or register this unit on your Yamaha MCX-2000.

- Refer to “Installing Windows Media Player 11 on your PC” and “Registering this unit on the Yamaha MCX-2000” (page 70).
- This procedure is needed only for the first time.
- (PC only) You may need to make some settings of Windows Media Player 11 to start the contents sharing. Refer to the attached documents of Windows Media Player 11.

2 Turn on your PC or MCX-2000.

3 Select “PC/MCX” in the “Music Contents” menu and then select the desired server or “MusicCAST” to begin playback.

Notes

- Yamaha MCX-2000 may not be for sale in some locations.
- You can connect this unit to up to 15 PC servers and 1 MCX-2000, and each server must be connected to the same subnet as this unit.
- Some WAV, MP3, MPEG-4 AAC, and WMA files on your PC may not be playable or may be noisy when played.
- (MCX-2000 only) Files marked with an asterisk (*) have not been converted to MP3 format. You cannot play back such files immediately unless you set the “Receive PCM Stream” setting of this unit to “ON” on MCX-2000. For details, refer to the instruction manual of MCX-2000.

■ Installing Windows Media Player 11 on your PC

With Windows Media Player 11, you can play back the audio files on your PC. For details refer to the documents of Windows Media Player 11.



You can also play back the audio files on your PC with Windows Media Connect 2.0 installed.

1 Install Windows Media Player 11 on your PC.

You can download the installer of Windows Media Player 11 from the Microsoft website, or use the upgrade function of the installed Microsoft Windows Media Player.

2 Turn on your PC and then share a folder on the PC.

The shared folder is added to the PC server list in the top “PC/MCX” menu screen.

Notes

- If the operating system (OS) of your PC is Windows Vista, Windows Media Player 11 is pre-installed (except some products).
- Some security software installed on your PC (anti-virus software, firewall software, etc.) may block the access of this unit to your PC. In such cases, configure the security software appropriately.

■ Registering this unit on the Yamaha MCX-2000

You must register this unit on your Yamaha MCX-2000 so that this unit can be recognized by your Yamaha MCX-2000. For details, refer to the operation manual supplied with your Yamaha MCX-2000.

1 Turn off this unit.

2 Set your Yamaha MCX-2000 to the “Auto Config” mode.

3 Turn on this unit.

- “MusicCAST” appears in the top “PC/MCX” menu screen.
- if the client ID for this unit appears in the OSD of your Yamaha MCX-2000 (shown as “CL-XXXXX”), the automatic configuration is complete.

Notes

- The latter part of the client ID for this unit is same as the last 5 digits of the MAC address of this unit.
- To clear the registered client ID of this unit, use the “Manual Config” mode of your Yamaha MCX-2000 (refer to the instruction manual of MCX-2000) and then select “NETWORK” in “ADVANCED SETUP” on this unit (page 122).
- The client control functions of MusicCAST over this unit other than “View Play Info”, “Receive PCM Stream” and “Edit Client title” are not available. Avoid using these functions as it will stop the playback on this unit.

Using the Internet Radio

Use this feature to listen to Internet Radio stations. This unit uses the vTuner Internet Radio station database service particularly customized for this unit, providing over 2000 radio station database. Further, you can store your favorite stations with bookmarks.

Notes

- This service may be discontinued without notice.
- Some Internet Radio stations may not be played.
- To listen to the Internet Radio, connect this unit to your network (page 23).
- A narrowband Internet connection (i.e. 56K modem, ISDN) will not provide satisfactory results, and a broadband connection is strongly recommended (i.e. a cable modem, an xDSL modem, etc.). For detailed information, consult with your ISP.



- “Podcast” is a type of the Internet Radio service, and there are a number of Podcast services available on the Internet. The Podcast is not a continuous service. That is, this unit stops playback when an episode of the Podcast ends.
- Some security devices (such as firewall) may block the access of this unit to Internet Radio stations. In such cases, configure the security settings appropriately.

■ Storing your favorite Internet Radio stations with bookmarks

Use this feature to select your favorite Internet Radio stations quickly.

Set the operation mode to **ⓅSOURCE and then press and hold **ⓈTITLE** while the selected Internet Radio station service is being broadcast.**

The stored Internet Radio station is added to the “Bookmarks” list (page 68).



- To remove the stored station from the list, select the station under “Bookmarks” and then press and hold **ⓈTITLE**.
- You can also register your favorite Internet Radio stations to this unit by accessing the following website with the web browser on your PC. To use this feature, you need the MAC address of this unit as the ID number and your e-mail address to create your personal account. Use “Information” in the “Network” menu to display the MAC address of this unit (page 96). For details, refer to the help information on the website. URL: <http://yradio.vtuner.com/>

Using the Rhapsody® service (U.S.A. model only)

Prohibition

You may not modify, reproduce, reverse-engineer or create derivative works based upon the software or any portion thereof.

The Rhapsody® service is the power behind the Rhapsody® Media Player (the Rhapsody® player software that you can download to your computer). Rhapsody® service supplies the music, keeps My Library up to date, provides you with Rhapsody® channels, the Playlist Central online community, and manages your downloads. Your software connects to Rhapsody® service through the internet. Because your account information and Rhapsody® content are on servers instead of any individual computer, your music is infinitely portable. Much of what you see in the Display area comes from Rhapsody® service. What you can do with Rhapsody® service depends on your subscription. You can use Rhapsody® service for free, or get even more from a paid membership. The Rhapsody® service also brings you Rhapsody® Online, a streamlined, internet version of Rhapsody® that you can access from almost anywhere. Just sign in to your Rhapsody® account to start letting the Rhapsody® service work for you.

For more information, <http://www.rhapsody-free.com/>.

■ Account setup for Rhapsody®

When you select “Rhapsody” as a sub input source for the first time, the account setup screen appears in the “Rhapsody” menu screen. Follow the procedure below to set up your account for the Rhapsody® service.

1 Press **Ⓢ / **◀** / **▶** to select “Formal registration” or “Trial registration” and then press **ⓈENTER**.**



If you select “Trial registration”, the URL for the content of the trial service appears. If you proceed, press **Ⓢ** / **◀** / **▶** to select “OK” and then press **ⓈENTER** to enter the Rhapsody menu.

2 Press **Ⓢ / **◀** / **▶** to select “OK” and then press **ⓈENTER**.**

3 Use **Ⓢ / **▲** / **▼** / **◀** / **▶** and **ⓈENTER** to input your user name (up to 64 characters), select “OK” and then press **ⓈENTER**.**

4 Press **Ⓢ / **◀** / **▶** to select “OK” and then press **ⓈENTER**.**

- 5 Use $\text{Ⓢ}/\text{Ⓡ}/\text{Ⓟ}/\text{Ⓛ}/\text{Ⓜ}$ and Ⓢ ENTER to input your password (up to 64 characters), select “OK” and then press Ⓢ ENTER.**

“Please wait...” appears and then top “Rhapsody” menu screen appears.

Note

If registration failed, the error message appears. In this case, start all over again.

■ Editing/deleting your account or checking trial information

- 1 In the top “Rhapsody” menu screen, press Ⓢ SUBMENU.**

The submenu screen appears.

- 2 Press $\text{Ⓢ}/\text{Ⓡ}/\text{Ⓟ}$ repeatedly to select “Upgrade account”, “Remove account” or “Show trial info” and then press Ⓢ ENTER.**

- If you selected “Upgrade account”, follow steps 2 to 5 in “Account setup for Rhapsody®”.
- If you selected “Remove account”, press $\text{Ⓢ}/\text{Ⓡ}/\text{Ⓟ}$ to select “OK” and then press Ⓢ ENTER to delete your account.
- If you selected “Show trial info”, check the trial information and then press Ⓢ ENTER.



“Show trial info” appears only when you are using the trial service.

■ Searching contents by keyword

Use this feature to search Rhapsody® music contents by artist, album name, or track name.

- 1 In the top “Rhapsody” menu screen, press $\text{Ⓢ}/\text{Ⓡ}$ to select “Search” and then press $\text{Ⓢ}/\text{Ⓟ}$.**

- 2 Press $\text{Ⓢ}/\text{Ⓡ}/\text{Ⓟ}$ repeatedly to select the category you want to search and then press Ⓢ ENTER.**

- 3 Use $\text{Ⓢ}/\text{Ⓡ}/\text{Ⓟ}/\text{Ⓛ}/\text{Ⓜ}$ and Ⓢ ENTER to input the desired keyword, select “OK” and then press Ⓢ ENTER.**

The list of the contents that match the specified keyword is displayed.



“No match data” appears if no content matches the specified keyword.

■ Submenu items in the “Rhapsody” menu

In the “Rhapsody” menu, the following submenu items are also available in addition to “Play Control” and “Play Style” (page 69).

Add to My Library

Select this item to add the track or album currently selected to “My Library”.

Add Album to My Library

Select this item to add the album currently selected to “My Library”.

Remove from My Library

Select this item to remove the track or album currently selected from “My Library”.

Play

Select this item to start playback of the item currently selected.



Available submenu items vary depending on the screen where you press Ⓢ SUBMENU.

Before performing the following operations, set the operation mode selector on the remote control to Ⓢ SOURCE and then press Ⓢ USB/NET.

Using shortcut buttons

Use this feature to access the desired music sources (WAV, MP3 and WMA files on the connected PC, MCX-2000 or USB storage devices, Internet Radio Stations, and Rhapsody® music contents) directly. You can preset 8 items for each sub input source.

■ Assigning the items to the numeric button (1-8) (Ⓢ)

- 1 Select a desired content you want to assign to a numeric button (1-8) (Ⓢ), and then play back the content.**

- 2 Press Ⓢ MEMORY (or Ⓢ MEMORY).**

The PRESET indicator lights up in the front panel and this unit automatically selects an empty preset number.

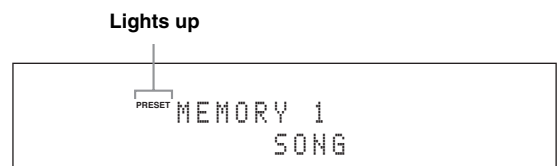



- To store the selected content under an empty preset number automatically, press and hold **ⓈMEMORY** (or **ⓈMEMORY**) for more than 2 seconds instead of step 2. In this case, the following steps are unnecessary.
- To cancel the preset, press **ⓈMEMORY** (or **ⓈMEMORY**) again.
- When you do not complete each of the following steps within 30 seconds, the memory preset mode is automatically canceled. In this case, start over from step 2.

3 Press a numeric button (1-8) (Ⓢ) that you want to assign.

Preset number



If you select a preset number being used (“*” appears next to the preset number), the current preset number will be overwritten.

4 Press **ⓈENTER** (or **ⓈENTER**).

The preset content is set and the PRESET indicator disappears.

■ Select an item by using numeric buttons (1-8) (Ⓢ)

Press one of the numeric button (1-8) (Ⓢ) to which the desired item is assigned to select the item as the input source.

This unit starts the playback of the source assigned to the selected numeric button.

Notes

- “Empty Memory!” appears in the front panel display and the short message display when you press the numeric button (1-8) (Ⓢ) to which no items are assigned.
- This unit does not recall the correct item assigned to the selected numeric button (1-8) (Ⓢ) in the following cases:
 - the connected USB device is incorrect.
 - the PC or MCX-2000 which stores the selected item is turned off or disconnected from the network.
 - the selected Internet Radio station or Rhapsody® service is temporary unavailable or out of service.
 - the directory of the selected item has been changed.



This unit stores the relative position of the preset items in a directory or playlist, and does not recall the correct item by using numeric buttons (1-8) (Ⓢ) if you add or delete music files to or from the same directory or playlist as the preset items. In such cases, preset the desired item to the numeric buttons (1-8) (Ⓢ) again.

We recommend the following methods:

USB storage devices

Create eight directories which contain the desired items in a directory beside the directory which contains all music files, and then preset the top item of each directory to the numeric buttons (1-8) (Ⓢ). When you change the items which are preset to the numeric buttons (1-8) (Ⓢ), replace the items in the directory to the desired items without deleting the directory.

PC server/MCX-2000

Create eight playlists which contain the desired items, and then preset the top item of each playlist to the numeric buttons (1-8) (Ⓢ). When you change the items which are preset to the numeric buttons (1-8) (Ⓢ), replace the registered items in the playlist with the desired items without deleting the playlist.

Advanced sound configurations

Selecting decoders

■ Selecting decoders for 2-channel sources (surround decode mode)

Use this feature to play back sources with selected decoders. You can play back 2-channel sources on multi-channels.

Set the operation mode selector to **AMP** and then press **SUR. DECODE** repeatedly on the remote control to select the surround decode mode.

You can select desired surround decoder modes depending on the type of source you are playing and your personal preference.



You can change the decoder parameter settings in “Stereo/ Surround” (page 80).

■ Decoder descriptions

Name of the decoder
(Decoder Type)

PLIIX Music
PLIIMusic

Dolby Pro Logic IIX (or Dolby Pro Logic II) processing for music sources. The Pro Logic IIX decoder is not available when “Surround Back” (page 88) is set to “None” or using headphones.

Decoder description

Pro Logic

Dolby Pro Logic processing for any sources.

PLIIX Movie
PLIIMovie

Dolby Pro Logic IIX (or Dolby Pro Logic II) processing for movie sources. The Pro Logic IIX decoder is not available when “Surround Back” (page 88) is set to “None” or using headphones.

PLIIX Music
PLIIMusic

Dolby Pro Logic IIX (or Dolby Pro Logic II) processing for music sources. The Pro Logic IIX decoder is not available when “Surround Back” (page 88) is set to “None” or using headphones.

PLIIX Game
PLIIGame

Dolby Pro Logic IIX (or Dolby Pro Logic II) processing for game sources. The Pro Logic IIX decoder is not available when “Surround Back” (page 88) is set to “None” or using headphones.

Neo:6 Cinema

DTS processing for movie sources.

Neo:6 Music

DTS processing for music sources.

CSII Cinema

(U.S.A. model only)

SRS Circle Surround II processing for movie sources.

CSII Music

(U.S.A. model only)

SRS Circle Surround II processing for music sources.

NRL-THX

(U.S.A. and Canada models only)

Neural-THX Surround processing for any sources. The Neural-THX Surround decoder is especially suitable for the XM HD Surround program of XM Satellite Radio.

NRL-THX Music

(U.S.A. and Canada models only)

Neural-THX Surround processing for music sources. The Neural-THX Surround decoder is especially suitable for the XM HD Surround music program of XM Satellite Radio.



When you select the surround decode mode for the multi-channel digital sources, this unit automatically selects the corresponding decoder for each source.

■ Selecting decoders used with MOVIE sound field programs

You can select one of the following decoder types for use with the MOVIE sound field programs (except “Mono Movie”). For details about the MOVIE sound field programs, see “For movie sources” (page 44). For details on how to select the decoder type, see “Sound field parameter descriptions” (page 81).

Choices: PLIIX Movie (PLIIMovie), Neo:6 Cinema

■ Selecting decoders for multi-channel sources

If you connected surround back speakers, use this feature to enjoy 6.1/7.1-channel playback for multi-channel sources using the Dolby Pro Logic IIX, Dolby Digital EX, DTS-ES, or Neural-THX decoders.

Set the operation mode selector to **ⒶAMP and then press **ⓈEXTD SUR.** on the remote control repeatedly to switch between 5.1 and 6.1/7.1-channel playback.**

Choice	Functions
AUTO	Activates the optimum decoder to play back signals in 6.1/7.1 channels when this unit recognizes a signal flag being input.
Decoders (PLIIX Movie, PLIIX Music, EX/ES, Neural-THX)	Use this feature to activate the desired decoders for the playback of multi-channel sources manually.
OFF	Does not use any decoders to create 6.1/7.1 channels.



Use this feature to activate the desired decoder manually when this unit cannot detect the signal flag encoded to the input sources correctly.

Notes

- The available decoders vary depending on the setting of the speakers and the input sources.
- 6.1/7.1-channel playback is not possible in the following cases:
 - when “Surround” (page 87) or “Surround Back” (page 88) is set to “None”.
 - when the component connected to the MULTI CH INPUT jacks is being played.
 - when the source being played does not contain surround left and right channel signals.
 - when a Dolby Digital KARAOKE source is being played.
 - when this unit is in the stereo playback, 7ch Enhancer (page 45) or PURE DIRECT (page 47) mode.
 - when “BI-AMP” is set to “ON” (page 122).
- If “EXTD Surround” is set to “Auto” (page 99), the decoder mode is automatically set to “AUTO” every time this unit is turned off.
- “Neural-THX” is only available on the U.S.A. and Canada models.

Graphical user interface (GUI) menu

■ GUI menu tree

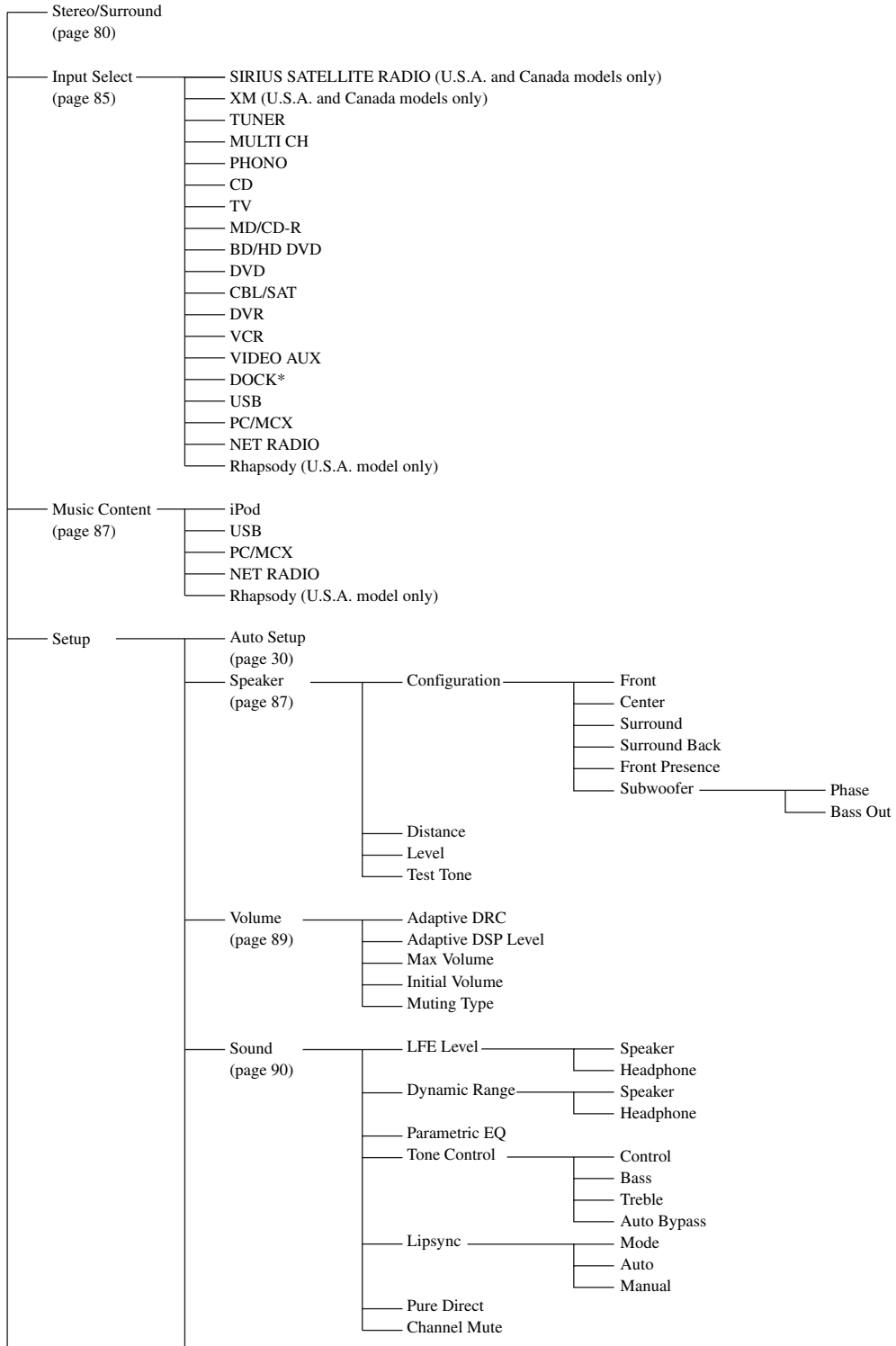

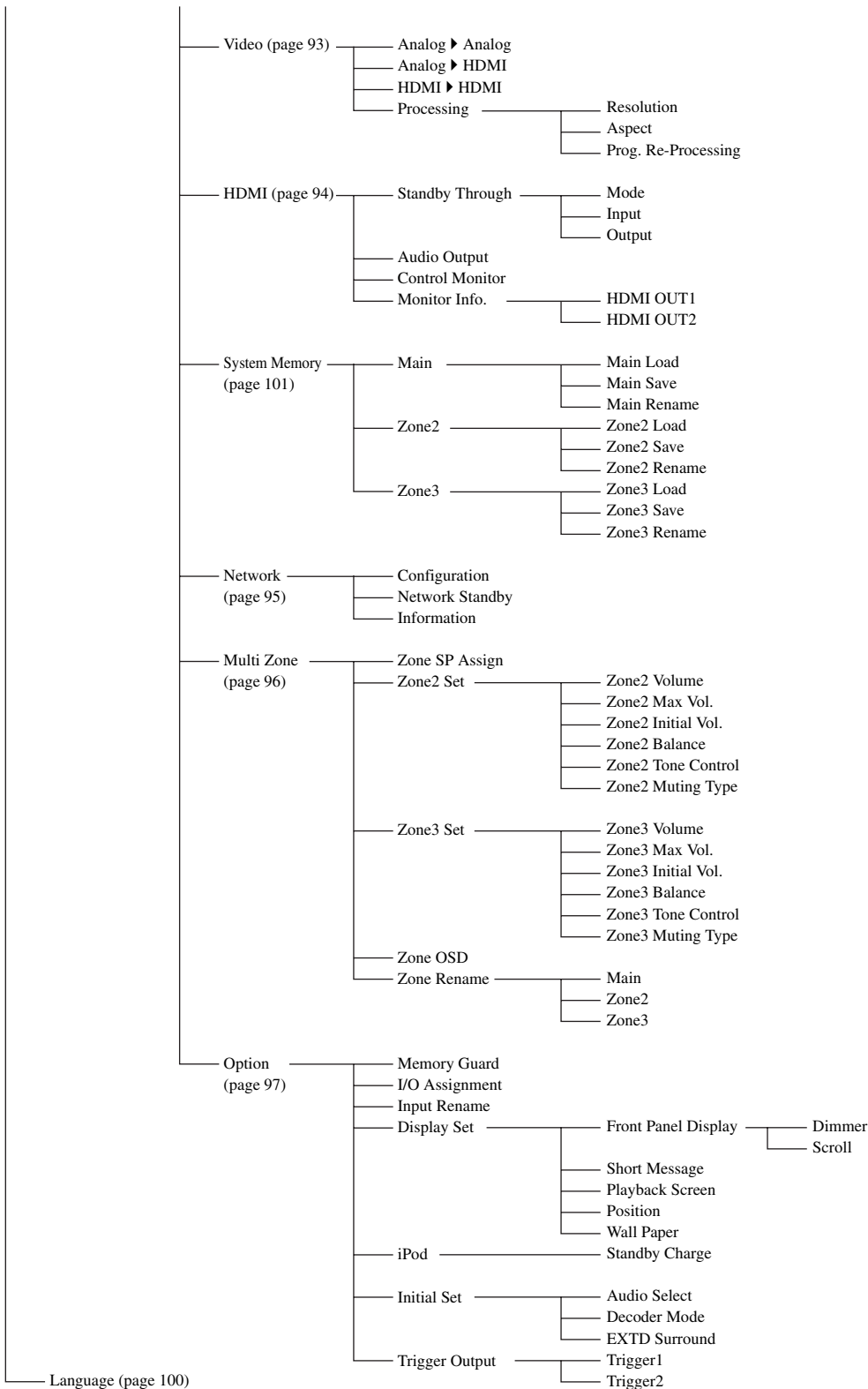

Note

* “iPod” appears when an iPod is stationed in a Yamaha iPod universal dock connected to the DOCK terminal. “Bluetooth” appears when a Yamaha Bluetooth receiver is connected to the DOCK terminal.

GUI menu overview

This unit features a sophisticated graphical user interface (GUI) menu that helps you to control the amplifier function of this unit. With the GUI menu, you can view the information of the signals being input and the status of this unit.



- Refer to “GUI menu tree” (page 76) for the complete menu structure.
- Refer to “GUI menu operations” (page 79) for details about the basic operations in the GUI menu.

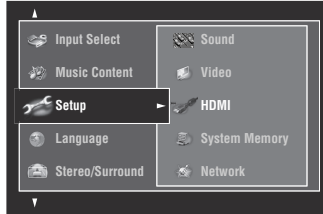

■ Stereo/Surround (Stereo/Surround menu)

Use this feature to select the sound field programs and customize the program parameter settings (page 80).

■ Input Select (Input select menu)

Use this feature to select the input source and customize the parameters of each input source (page 85).

■ Music Content (Music content menu)

Use this feature to browse the music contents of iPod, USB component, PC/MusicCAST, Internet radio, and Rhapsody® (U.S.A. model only) (page 87).

■ Setup (Setup menu)

Use this feature to manually adjust speaker and system parameters.

Auto Setup (Automatic setup menu)

Use this feature to run the automatic setup and specify which speaker parameters to be adjusted (page 30).

Speaker (Speaker menu)

See page 87 for details.

Volume (Volume menu)

See page 89 for details.

Sound (Sound menu)

See page 90 for details.

Video (Video menu)

See page 93 for details.

HDMI (HDMI menu)

See page 94 for details.

System Memory (System memory menu)

See page 101 for details.

Network (Network menu)

See page 95 for details.

Multi Zone (Multi-zone menu)

See page 96 for details.

Option (Option menu)

See page 97 for details.

■ Language (Display language menu)

Use this feature to select the language that appears in the front panel display or in the GUI menu of this unit (page 100).

GUI menu operations

This unit features a sophisticated graphical user interface (GUI) menu that helps you to control the amplifier function of this unit. With the GUI menu, you can view the information of the signals being input and the status of this unit. You can also set up this unit using the GUI menu.

■ Items in the GUI menu

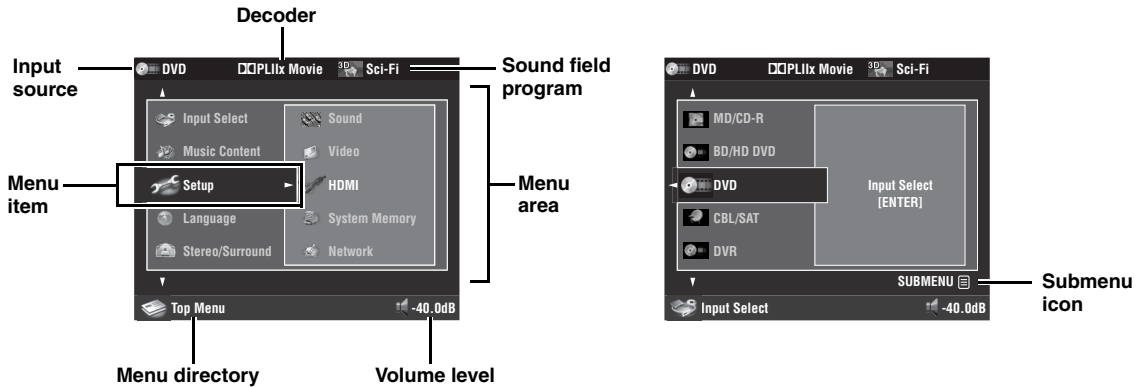

■ Remote control operation



Set the operation mode selector to **AMP** when you operate the GUI menu using the remote control.

Button	Function
▲ / ▼	Selects the item in the current menu level.
▶	Selects the currently selected menu item and moves to the next menu level.
◀	Returns to the previous menu level.
ENTER	Selects the currently selected menu item and moves to the next menu level.
SUBMENU	Turns on or off the submenu. (The submenu icon appears when any submenu items exist under the menu currently selected.)
MENU	Turns on or off the GUI menu. Press and hold MENU to display the top GUI menu (Top Menu).

Note

If you simply press **MENU**, the menu directory displayed before you turned off the GUI menu appears. To display the top GUI menu (Top Menu), press and hold **MENU**.

■ Front panel control operation

Control	Function
MENU	Turns on or off the GUI menu.
▶	Selects the currently selected menu item and moves to the next menu level.
◀	Returns to the previous menu level.
ENTER	Selects the currently selected menu item and moves to the next menu level.
PROGRAM	Selects the item in the current menu level.

Stereo/Surround

You can enjoy good quality sound with the initial factory settings. Although you do not have to change the initial factory settings, you can change some of the parameters to better suit the input source or your listening room.



To customize the program parameter settings, press **Ⓜ SUBMENU** to turn on the submenu after you select the desired program.

■ Basic configuration of sound field programs

Each sound field program has some parameters defining the characteristics of the program. To customize the selected sound field program, adjust “DSP Level” and/or “Dialogue Lift” first, and then try other parameters.

Adjusting the effect sound level of the sound field programs (DSP Level)

Sound field programs add effect sounds (DSP effect sounds) to the original source sound to create sound field in the listening room. Use the “DSP Level” parameter to adjust the level of the effect sounds.

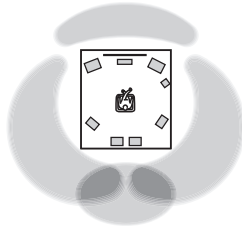

The DSP effect sound level is low

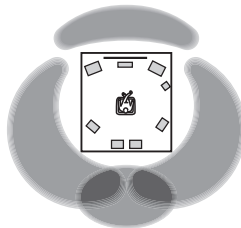

The DSP effect sound level is high

Adjust “DSP Level” as follows:

Increase the value of “DSP Level” when

- the effect sound of the selected sound field program is too weak.
- you cannot recognize any difference between the sound field programs.

Decrease the value of “DSP Level” when

- the sound is vague.
- you feel that the additional sound effect is excessive.

Control range: -6 dB to +3 dB

Adjusting the vertical dialogue position (Dialogue Lift)

Use this feature to adjust the vertical position of the dialogues in movies. The ideal position of the dialogues is at the center of the video monitor screen.

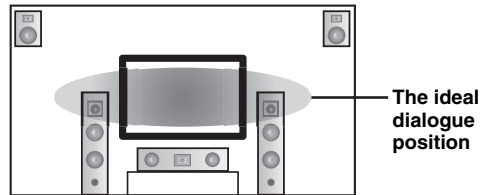

If the dialogues are heard at the lower position of the video monitor screen, increase the value of “Dialogue Lift”.

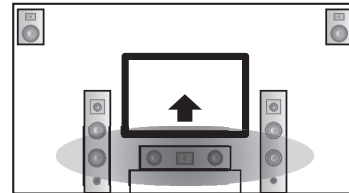

Move up to the ideal dialogue position

Choices: 0, 1, 2, 3, 4, 5

“0” (initial setting) is the lowest position, and “5” is the highest position.

Notes

- “Dialogue Lift” is available when “Front Presence” is set to “Yes” (page 88) and headphones are not connected.
- You cannot move the dialogue position down from the initial dialogue position.

■ Sound field parameter descriptions

You can adjust the values of certain digital sound field parameters so that the sound fields are recreated accurately in your listening room. Not all of the following parameters are found in every program.

Sound field parameter	Features
Decode Type	Decoder type. Select the decoder used with the selected sound field program. The decoder parameters for "Surround Decoder" vary depending on the selected decoder type. See page 84 for details.
Init. Delay Sur. Init. Delay SB. Init. Delay	<p>Initial delay. Presence, surround, and surround back sound field initial delay. Changes the apparent size of the sound field by adjusting the delay between the direct sound and the first reflection heard by the listener. The smaller the value, the smaller the sound field seems to the listener.</p> <p>☀️ When you adjust the initial delay parameters, we also recommend that you adjust the corresponding room size parameters likewise.</p> <p>Control range: 1 to 99 ms (Init. Delay) 1 to 49 ms (Sur. Init. Delay and SB Init. Delay)</p>

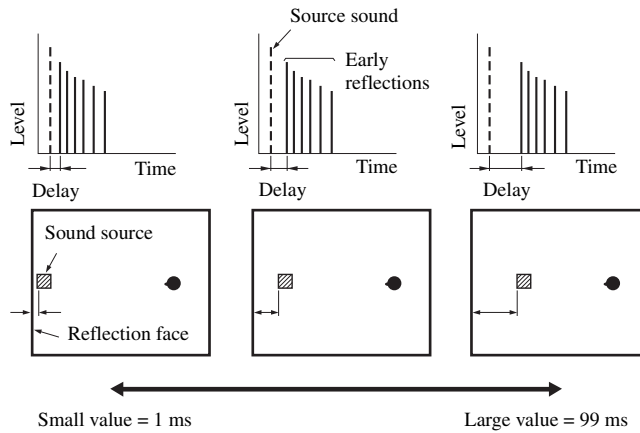

Room Size Sur. Room Size SB. Room Size	<p>Room size. Presence, surround, and surround back room size. Adjusts the apparent size of the sound field. The larger the value, the larger the surround sound field becomes. As the sound is repeatedly reflected around a room, the larger the hall is, the longer the time between the original reflected sound and the subsequent reflections. By controlling the time between the reflected sounds, you can change the apparent size of the virtual venue. Changing this parameter from one to two doubles the apparent length of the room.</p> <p>☀️ When you adjust the room size parameters, we also recommend that you adjust the corresponding initial delay parameters likewise.</p> <p>Control range: 0.1 to 2.0</p>
---	--

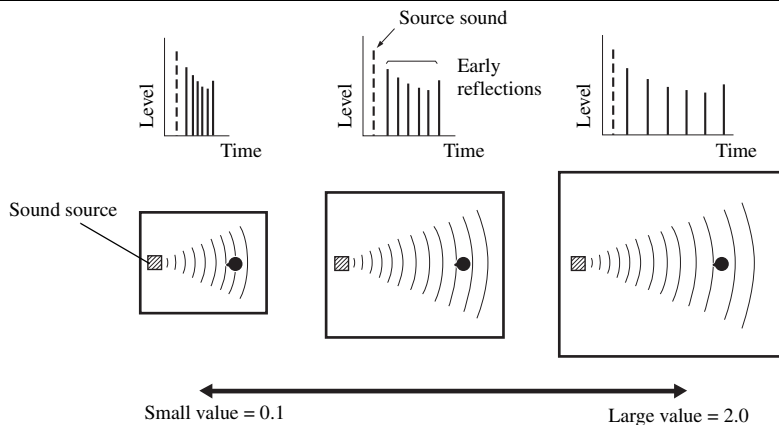

Sound field parameter	Features
Liveness Sur. Liveness SB. Liveness	Liveness, Surround and surround back liveness. Adjusts the reflectivity of the virtual walls in the hall by changing the rate at which the early reflections decay. The early reflections of a sound source decay much faster in a room with acoustically absorbent wall surfaces than in one which has highly reflective surfaces. A room with acoustically absorbent surfaces is referred to as "dead", while a room with highly reflective surfaces is referred to as "live". This parameter lets you adjust the early reflection decay rate and thus the "liveness" of the room.
Control range: 0 to 10	

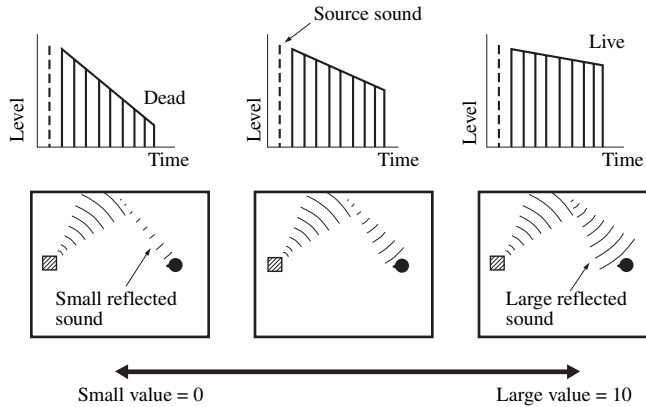

Rev. Time	Reverberation time. Adjusts the amount of time taken for the dense, subsequent reverberation sound to decay by 60 dB at 1 kHz. This changes the apparent size of the acoustic environment over an extremely wide range. Set a longer reverberation time to get more sustaining reverberation sound, and set a shorter time to get articulate sound.
Control range: 1.0 to 5.0 s	

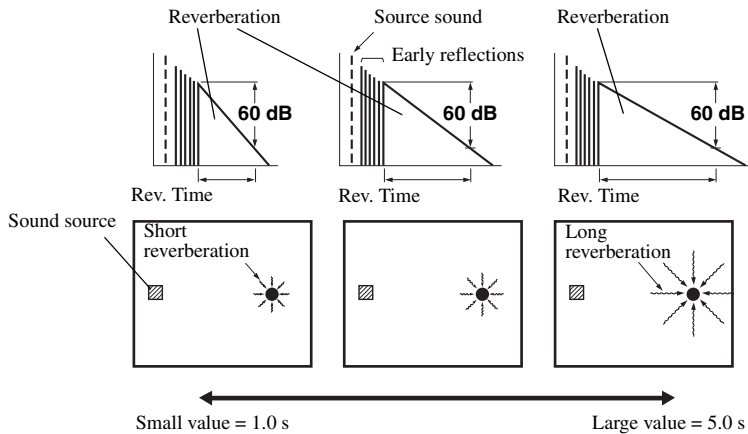

Sound field parameter	Features
Rev. Delay	Reverberation delay. Adjusts the time difference between the beginning of the direct sound and the beginning of the reverberation sound. The larger the value, the later the reverberation sound begins. A later reverberation sound makes you feel as if you are in a larger acoustic environment.
	Control range: 0 to 250 ms

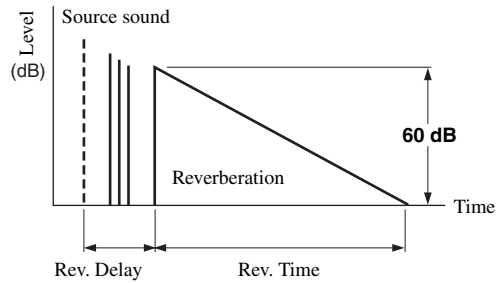

Rev. Level	Reverberation level. Adjusts the volume of the reverberation sound. The larger the value, the stronger the reverberation becomes.
	Control range: 0 to 100%

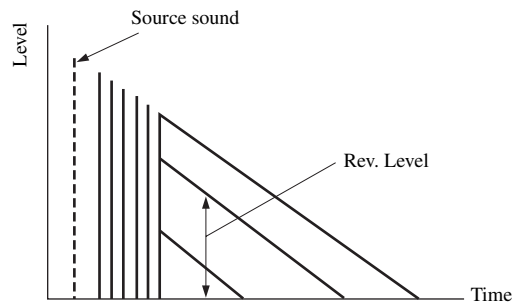

■ Stereo program parameter descriptions

Sound field parameter	Features
Direct ("2ch Stereo" only)	<p>2-channel stereo direct. Bypasses the decoders and DSP processors of this unit for pure hi-fi stereo sound when playing 2-channel analog sources.</p> <p>Choices: Auto, Off</p> <p>☞</p> <ul style="list-style-type: none"> Select "Auto" to bypass the decoders, DSP processors and the tone control circuitry only when "BASS" and "TREBLE" are set to "BYPASS" (page 47). Select "Off" not to bypass the decoders, DSP processors and the tone control circuitry when "BASS" and "TREBLE" are set to "BYPASS". When multi-channel signals are input, they are downmixed to 2 channels and output from the front left and right speakers. The low-frequency signals of the front left and right channels are redirected to the subwoofer in the following cases: <ul style="list-style-type: none"> – "Bass Out" is set to "Front + SWFR" (page 88). – "Front" is set to "Small" (page 87) and "Bass Out" is set to "SWFR" (page 88).
Center Level Surround L Level Surround R Level Sur.Back L Level Sur.Back R Level F.PRNS L Level F.PRNS R Level ("7ch Stereo" only)	<p>7-channel stereo center, surround left, surround right, surround back, presence left and presence right levels. Adjusts the volume level of each channel in the 7-channel stereo mode. The available parameters differ depending on the speaker settings.</p> <p>Control range: 0 to 100%</p>

■ Compressed Music Enhancer mode parameter descriptions

The Compressed Music Enhancer mode	Features
Level (“Straight Enhancer” and “7ch Enhancer” only)	Straight enhancer or 7-channel enhancer effect level. Select “High” or “Low” to adjust the effect for the high-frequency. Choices: High , Low

■ Decoder parameter descriptions

Decoder parameter	Features
Panorama (“PLIIX Music” and “PLII Music” only)	Pro Logic IIX Music and Pro Logic II Music panorama. Sends stereo signals to the surround speakers as well as the front speakers for a wraparound effect. Choices: Off , On
Center Width (“PLIIX Music” and “PLII Music” only)	Pro Logic IIX Music and Pro Logic II Music center width. Moves the center channel output completely towards the center speaker or towards the front left and right speakers. A larger value moves the center channel output towards the front left and right speakers. Control range: 0 (center channel sound is output only from the center speaker) to 7 (center channel sound is output only from the front left and right speakers) Initial setting: 3
Dimension (“PLIIX Music” and “PLII Music” only)	Pro Logic IIX Music and Pro Logic II Music dimension. Adjusts the sound field either towards the front or towards the rear. Control range: -3 (towards the rear) to +3 (towards the front) Initial setting: STD (standard)
Center Image (“Neo:6 Music” only)	DTS Neo:6 Music center image. Adjusts the front left and right channel output relative to the center channel to make the center channel more or less dominant as necessary. Control range: 0.0 (center channel sound is output only from the front left and right speakers) to 1.0 (center channel sound output only from the center speaker) Initial setting: 0.3
FOCUS (“CSII Cinema” and “CSII Music” only)	SRS Circle Surround II Cinema and SRS Circle Surround II Music focus. Adjusts the clearness of a sound image by elevating the perception of the sound image to compensate for non-optimally placed speakers from a lower location. A larger value makes speakers sound as if they are positioned at ear level. Control range: 0 (lower location) to 8 (higher location)
TruBass (“CSII Cinema” and “CSII Music” only)	SRS Circle Surround II Cinema and SRS Circle Surround II Music TruBass. Adjusts the lower register by producing the perception of improved low frequency performance. A larger value improves bass even without a subwoofer and provides deeper, richer bass in the presence of a subwoofer. Control range: 0 (standard low-frequency performance) to 8 (enhanced low-frequency performance)

■ Initialize (Parameter initialization)

Use this feature to initialize the parameter of the selected sound field program.

Choices: **No**, Yes

- Select “Yes” and then press **ⓈENTER** to set the program parameters to the factory default settings.
- Select “No” (or press **Ⓢ◀**) to cancel the program parameter initialization.



Use “DSP PARAM” of “INITIALIZE” in “Advanced setup” to initialize the parameters of all sound field programs (page 122).

Input Select

Use this menu to adjust the parameters of each input source.



To customize the input source settings, press **ⓂSUBMENU** to turn on the submenu after you select the input source.

Input source	Parameter
SIRIUS SATELLITE RADIO (U.S.A. and Canada models only)	Volume Trim Parental Lock
XM (U.S.A. and Canada models only) iPod USB PC/MCX NET RADIO Rhapsody (U.S.A. model only)	Volume Trim
TUNER	Volume Trim Station Search (U.S.A. model only)
MULTI CH	Volume Trim Multi CH Assign BGV
PHONO CD TV MD/CD-R BD/HD DVD DVD CBL/SAT DVR VCR VIDEO AUX	Audio Select Decoder Mode Volume Trim
Bluetooth	Volume Trim Pairing Connect

Audio Select (Audio input jack selection)

Use this feature to select the type of the input jack you want to use.

Choice	Functions
Auto	Automatically selects input signals in the following order: (1) HDMI (2) Digital signals (3) Analog signals
HDMI	Selects only HDMI signals. When HDMI signals are not input, no sound is output.
Coax/Opt	Automatically selects input signals in the following order: (1) Digital signals input at the COAXIAL jack. (2) Digital signals input at the OPTICAL jack. When no signals are input, no sound is output.
Analog	Selects only analog signals. If no analog signals are input, no sound is output.



- You can also select the audio input jack by pressing **ⓂAUDIO SELECT** (or **ⓂAUDIO SEL**) (page 37).
- You can set the default audio input jack select of this unit by using “Audio Select” in “Initial Set” (page 99).

Note

This feature is not available if no digital input jack is assigned to the selected input source in “I/O Assignment” (page 98). “HDMI” is available only when an HDMI input jack is assigned.

Decoder Mode (Decoder mode)

Use this feature to switch the decoder mode.

Choice	Functions
Auto	Automatically detects digital audio signal input types and selects the appropriate decoder.
DTS	Activates the DTS decoder when digital audio signals are input.

Note

“Decoder Mode” is available only when the digital audio input jacks (HDMI, OPTICAL and/or COAXIAL) are assigned to the selected input source.

Volume Trim (Volume trimming)

Use this feature to adjust the level of the signal input at each input source. This feature is useful if you want to balance the level of each input source to avoid sudden changes in volume when switching between input sources. Control range: -6.0 dB to +6.0 dB
Initial setting: 0.0 dB



This parameter also affects the signals output at the ZONE OUT jacks.

■ Parental Lock (SIRIUS Satellite Radio parental lock)

Use this feature to set the code number for locking the desired SIRIUS Satellite Radio channels. Refer to “Setting the Parental Lock” (page 62) for details.

■ Station Search (Station search) (U.S.A. model only)

You can search for preset HD Radio stations by specifying a keyword (station name).

1 Press Ⓢ / Ⓢ / Ⓢ / Ⓢ to select a character or function and then press Ⓢ ENTER to confirm the selection.

Repeat step 1 until you input a keyword you want to use.

2 Press Ⓢ / Ⓢ / Ⓢ / Ⓢ to select “OK” and then press Ⓢ ENTER.

The search result is displayed.



If your keyword does not match any station, “Not Found” appears. Press Ⓢ to return to the previous screen.

3 Press Ⓢ / Ⓢ to select the preset HD Radio station you want to listen to and then press Ⓢ ENTER.

■ Multi CH Assign (Multi channel assignment)

Use this feature to set the direction of the signals input into the center, subwoofer and surround channels when a source component is connected to the MULTI CH INPUT jacks.

Input Channels (Input channels)

Use this setting to select the number of channels input from an external decoder (page 22).

Choice	Description
6ch	Select “6ch” the connected component outputs discrete 6-channel audio signals.
8ch	Select “8ch” the connected component outputs discrete 8-channel audio signals. Also set “Front Input” (see below) to the analog audio jacks at which the front left and right channel signals output from the connected component are input.

Note

Depending on the settings of the zone configuration, no sound is output at the surround back speakers even if you set “Input Channels” to “8ch”. In this case, select “6ch” and set the audio output setting of the source component to 6 channels.

Front Input (Front channel input jacks)

If you selected “8ch” in “Input Channels”, you can select analog jacks at which front left and right channel signals from an external decoder will be input.

Choices: CD, TV, MD/CD-R, BD/HD DVD, **DVD**, CBL/SAT, DVR, VCR, VIDEO AUX

Note

If you have renamed an input source in “Input Rename” (page 98), the name of the input source appears in the choices of this parameter.

■ BGV (Back ground video)

Use this feature to select the video source played in the background of the sources input at the MULTI CH INPUT jacks.

Choice	Functions
BD/HD DVD, DVD, CBL/SAT, DVR, VCR, VIDEO AUX	Selects the corresponding input source as the background video source.
Off	Does not play the video source in the background.

Note

If you have renamed an input source in “Input Rename” (page 98), the name of the input source appears in the choices of this parameter.

■ Pairing (Bluetooth pairing)

Use this feature to start pairing the connected Yamaha Bluetooth wireless audio receiver (such as YBA-10, sold separately) with your Bluetooth component. For details about the pairing, refer to “Pairing the Bluetooth™ receiver and your Bluetooth component” (page 64).

To ensure security, a time limit of 8 minutes is set for the pairing operation. You are recommended to read and fully understand all the instructions before starting.

1 Press Ⓢ ENTER to start pairing.

The connected Bluetooth receiver starts searching Bluetooth components.

2 Check that the Bluetooth component detects the Bluetooth receiver.

For details, refer to the instruction manual of the Bluetooth component.

3 Select the Bluetooth receiver in the Bluetooth device list and then enter the pass key “0000” on the Bluetooth component.

Once this unit completes the pairing successfully, “Completed” appears.

4 Press **Ⓢ**◀ to return to the previous menu level.

Note

If the connected Bluetooth receiver cannot find any Bluetooth components, “Not found” appears.

■ Connect (Bluetooth connection)

Use this feature to establish a connection between the Yamaha Bluetooth wireless audio receiver (such as YBA-10, sold separately) and your Bluetooth component.

Note

Pairing must be performed when using a Bluetooth component with the Bluetooth receiver connected to this unit for the first time if the pairing data has been deleted.

Press **Ⓢ**ENTER to establish a connection.

The connected Bluetooth receiver starts searching Bluetooth components. Once the connection is established successfully, “BT Connected” appears.

Note

If the connected Bluetooth receiver cannot find any Bluetooth components, “Not found” appears.



To terminate the connection, press **Ⓢ**ENTER again.

Music Content

Use this feature to browse the music contents of iPod, USB component, PC/MusicCAST, Internet radio and Rhapsody® (U.S.A. model only). See the following pages for details.

- iPod (page 66)
- USB (page 68)
- PC/MCX (page 68)
- NET RADIO (page 68)
- Rhapsody (page 68)

Setup (Speaker)

Use this feature to manually adjust the basic speaker settings. Most of the “Speaker” parameters are set automatically when you run the automatic setup.



- Set “Test Tone” to “On” to output the test tone for the “Configuration”, “Distance” and “Level” settings.
- If your subwoofer can adjust the output volume and the crossover frequency, set the volume to about half way (or slightly less) and set the crossover frequency to the maximum.

■ Configuration (Speaker configurations)

Measure for the speaker size

The woofer section of a speaker is

- 16 cm (6.5 in) or larger: large
- smaller than 16 cm (6.5 in): small

Front (Front speakers)

Choice	Descriptions
Large	Select this setting when the front speakers are large.
Small	Select this setting when the front speakers are small.

Note

When “Bass Out” is set to “Front” (page 88), you can select only “Large” in “Front”. If the value of “Front” is set to other than “Large” in advance, this unit change the value to “Large” automatically.

Center (Center speaker)

Choice	Descriptions
Large	Select this setting when the center speaker is large.
Small	Select this setting when the center speaker is small.
None	Select this setting when you do not use the center speaker. The center channel signals are directed to the front left and right speakers.

Surround (Surround left/right speakers)

Choice	Descriptions
Large	Select this setting when the surround speakers are large.
Small	Select this setting when the surround speakers are small.
None	Select this setting when you do not use the surround speakers. This unit is set to the Virtual CINEMA DSP mode (page 45), and “Surround Back” is automatically set to “None”.

Surround Back
(Surround back left/right speakers)

Choice	Descriptions
Large x1	Select this setting when the single surround back speaker is large.
Small x1	Select this setting when the single surround back speaker is small.
Small x2	Select this setting when the surround back left and right speakers are small.
Large x2	Select this setting when the surround back left and right speakers are Large.
None	Select this setting when you do not use the surround back speakers. The surround back channel signals are directed to the surround left and right speakers.

Note

If you are only using one surround back speaker, connect it to the SUR.BACK SINGLE jack, and configure the “Surround Back L” settings under “Distance” and “Level”.

Cross Over (Cross over)

Use this feature to select the crossover frequency of the speaker(s) that is set to “Small”. All frequencies below the selected frequency will be sent to the subwoofer or to the speakers set to “Large” in “Configuration”.

Choices: 40Hz, 60Hz, **80Hz**, 90Hz, 100Hz, 110Hz, 120Hz, 160Hz, 200Hz

Front Presence (Front presence speakers)

Use this feature if you want to use the front presence speakers connected to this unit.

Choice	Descriptions
Yes	Select this setting when you use the front presence speakers.
None	Select this setting when you do not use the front presence speakers.

Subwoofer (Subwoofer)

Phase (Subwoofer phase)

Use this feature to switch the phase of your subwoofer if bass sounds are lacking or unclear.

Choice	Functions
Normal	Does not change the phase of your subwoofer.
Reverse	Sets the phase of the subwoofer to reverse.

Bass Out (Bass out)

Use this feature to select the speakers that output the LFE (low-frequency effect) and the low-frequency signals.

LFE signals output

Choice	Subwoofer and speakers		
	Subwoofers	Front speakers	Other speakers
Front + SWFR	Output	No output	No output
SWFR	Output	No output	No output
Front	No output	Output	No output

Low-frequency signals output

Choice	Subwoofer and speakers		
	Subwoofers	Front speakers	Other speakers
Front + SWFR	*1	*2	*3
SWFR	*4	*3	*3
Front	No output	*1	*3

- *1 Output(s) the low-frequency signals of the front channels and other speakers set to “Small”.
- *2 Always output the low-frequency signals of the front channels.
- *3 Output the low-frequency signals if the speakers are set to “Large”.
- *4 Outputs the low-frequency signals of the speakers set to “Small”.

■ **Distance (Speaker distance)**

Use this feature to manually adjust the distance of each speaker and the delay applied to the respective channel. Ideally, each speaker should be the same distance from the main listening position. However, this is not possible in most home situations. Thus, a certain amount of delay must be applied to the sound from each speaker so that all sounds will arrive at the listening position at the same time.

Unit (Unit)

Selects the unit for displaying the values of “Distance” parameter.

Initial setting: Feet (U.S.A. and Canada models)
Meter (Other models)

Choice	Functions
Meter (m)	Adjusts speaker distances in meters.
Feet (ft)	Adjusts speaker distances in feet.

Speaker distances

Control range: 0.30 to 24.00 m (1.0 to 80.0 ft)

Initial setting: 3.00 m (10.0 ft)

Control step: 0.05 m (0.2 ft)

Distance	Adjusted speaker
Front L	Front left speaker
Front R	Front right speaker
Center	Center speaker
Surround L	Surround left speaker
Surround R	Surround right speaker
Surround Back L	Surround back left speaker
Surround Back R	Surround back right speaker
Front Presence L	Front presence left speaker
Front Presence R	Front presence right speaker
Subwoofer	Subwoofer

Note

The available speaker channels differ depending on the setting of the speakers.

Level (Speaker level)

Use this feature to manually balance the speaker levels between the front left or surround left speakers and each speaker selected in “Configuration” (page 87).

Control range: -10.0 dB to +10.0 dB

Initial setting: 0.0 dB

Control step: 0.5 dB

Level	Adjusted speaker
Front L	Front left speaker
Front R	Front right speaker
Center	Center speaker
Surround L	Surround left speaker
Surround R	Surround right speaker
Surround Back L	Surround back left speaker
Surround Back R	Surround back right speaker
Front Presence L	Front presence left speaker
Front Presence R	Front presence right speaker
Subwoofer	Subwoofer



If you use a handheld sound pressure level meter, hold at arm's length and point upwards so that the meter is in the listening position. With the meter set to the 70 dB scale and to C SLOW, calibrate each speaker to 75 dB.

Note

The available speaker channels differ depending on the setting of the speakers.

Setup (Volume)

Use this menu to manually adjust the various volume settings.

Adaptive DRC (Adaptive dynamic range control)

Use this feature to adjust the dynamic range in conjunction with the volume level. This feature is useful when you are listening at lower volumes or at night. When “Adaptive DRC” is set to “Auto”, this unit controls the dynamic range as follows:

- If the VOLUME setting is low: the dynamic range is narrow
- If the VOLUME setting is high: the dynamic range is wide

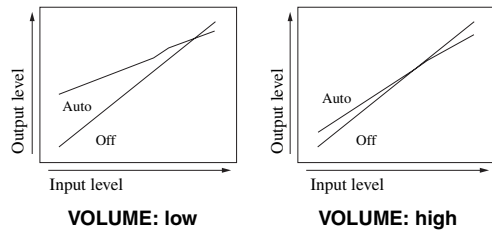

Choice	Functions
Auto	Adjusts the dynamic range automatically.
Off	Does not adjust the dynamic range automatically.



- You can also adjust the dynamic range of the bitstream signal sources by using “Dynamic Range” in “Sound” (page 90).
- This function is also useful for listening with your headphones.

Note

The adaptive dynamic range control feature does not function when this unit is in the PURE DIRECT mode (page 47).

Adaptive DSP Level (Adaptive DSP effect level)

Use this feature to make fine adjustments of the DSP effect level (page 80) automatically in conjunction with the volume level.

Choice	Functions
Auto	Adjusts the DSP effect level in conjunction with the volume level.
Off	Does not adjust the DSP effect level automatically.

Note

Even if you set “Adaptive DSP Level” to “Auto”, this unit does not change but fine-tunes the specified value of “DSP Level” (page 80).

Max Volume (Maximum volume)

Use this feature to set the maximum volume level in the main zone. This feature is useful to avoid the unexpected loud sound by mistake. For example, the original volume range is -80.0 dB to +16.5 dB. However, when “Max Volume” is set to -5.0 dB, the volume range becomes -80.0 dB to -5.0 dB. Control range: -30.0 dB to +15.0 dB, **+16.5 dB**
Control step: 5.0 dB

Initial Volume (Initial volume)

Use this feature to set the volume level of the main zone when the power of this unit is turned on.
Choices: **Off**, Mute, -80.0 dB to +16.5 dB
Control step: 0.5 dB

Notes

- When this unit is in the auto setup procedure, the volume level is automatically set to 0 dB regardless of the current “Max Volume” setting.
- The “Max Volume” setting takes priority over the initial volume setting.

Muting Type (Muting type)

Use this feature to adjust how much the mute function reduces the output volume (page 38).

Choice	Functions
Full	Mutes all the audio output.
-20dB	Reduces the current volume by 20 dB.
-40dB	Reduces the current volume by 40 dB.

Setup (Sound)

Use this menu to adjust the sound parameters.

■ LFE Level (Low-frequency effect level)

Use this feature to adjust the output level of the LFE (low-frequency effect) channel according to the capacity of your subwoofer or headphones. The LFE channel carries low-frequency special effects which are only added to certain scenes. This setting is effective only when this unit decodes bitstream signals.
Control range: -20.0 to **0.0** dB
Control step: 1.0 dB

Speaker (Speaker low-frequency effect level)

Select to adjust the speaker LFE level.

Headphone

(Headphone low-frequency effect level)

Select to adjust the headphone LFE level.

Note

Depending on the settings of “Bass Out” (page 88), some signals may not be output at the SUBWOOFER PRE OUT jacks.

■ Dynamic Range (Dynamic range)

Use this feature to select the amount of dynamic range compression to be applied to your speakers or headphones. This setting is effective only when the unit is decoding bitstream signals.

Speaker (Speaker dynamic range)

Adjusts the dynamic range compression for the speakers.

Headphone (Headphone dynamic range)

Adjusts the dynamic range compression for the headphones.

Choice	Functions
MAX	Preserves the greatest amount of dynamic range.
STD	Adjusts the dynamic range to medium. When this unit is decoding Dolby TrueHD signals, the dynamic range control is always active regardless of the instruction of the input source signals.
MIN/AUTO	<ul style="list-style-type: none"> • MIN: Adjusts the dynamic range to narrow when this unit is decoding bitstream signals (except Dolby TrueHD). • AUTO: Adjusts the dynamic range according to the instruction of the input source signals when this unit is decoding Dolby TrueHD signals.

■ Parametric EQ (Parametric equalizer)

Use this feature to adjust the parametric equalizer of each speaker.

PEQ Data Copy (Parametric equalizer data copy)

Use this feature to copy the result data of the automatic setup to the manual configuration area. You can select the parametric equalizer type applied to the copied result data of the automatic setup. See page 35 for the descriptions of each parametric equalizer type.

Choice	Descriptions
Flat ▷ Manual	Copies the result of the automatic setup that the “Flat” type parametric equalizer is applied to.
Front ▷ Manual	Manual Copies the result of the automatic setup that the “Front” type parametric equalizer is applied to.
Natural ▷ Manual	Copies the result of the automatic setup that the “Natural” type parametric equalizer is applied to.

PEQ Select (Parametric equalizer type select)

Use this feature to select the parametric equalizer type that applied to the results of the automatic setup. page 35 for the descriptions of each parametric equalizer type.

Choice	Descriptions
Manual	Applies the manually configured parametric equalizer in "Setup".
Flat	Applies the "Flat" type parametric equalizer.
Front	Applies the "Front" type parametric equalizer.
Natural	Applies the "Natural" type parametric equalizer.
Through	Does not use the parametric equalizer.

Notes

- When you carry out the automatic setup, this unit automatically set "PEQ Select" to "Natural".
- "Level" settings (page 89) also change corresponding to the setting of "PEQ Select".
- This unit does not change the configurations of "Manual" even if you perform the automatic setup.

Manual parametric equalizer configuration of each speaker

Use this feature to adjust the tonal quality of each speaker. You can copy the results of the automatic setup for the base of the manual configuration by using "PEQ Data Copy". Set "PEQ Select" to "Manual" in advance.

1 Press **Ⓢ** / **⏪** / **⏩** / **⏴** / **⏵** to select "Test Tone" or the speaker you want to adjust.

Choice	Adjusted speaker
Front L	Front left speaker
Front R	Front right speaker
Center	Center speaker
Surround L	Surround left speaker
Surround R	Surround right speaker
Surround Back L	Surround back left speaker
Surround Back R	Surround back right speaker
Front Presence L	Front presence left speaker
Front Presence R	Front presence right speaker
Subwoofer	Subwoofer

Test Tone

Use this feature to select whether to turn on or off the test tone output while you are adjusting the tonal quality of each speaker.

Choice	Functions
On	Outputs the test tone.
Off	Does not output the test tone.

2 Press **Ⓢ** / **⏪** to access the settings window.

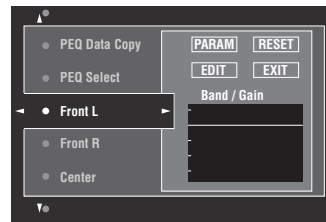

3 Press **Ⓢ** / **⏪** / **⏩** / **⏴** / **⏵** to select "PARAM" and then press **Ⓢ** / **ENTER** repeatedly to select a parameter from "Band" (band), "Freq." (frequency) or "Q" (Q factor).



You can adjust "Gain" (gain) with any parameter.

4 Press **Ⓢ** / **⏪** to select "EDIT" and press **Ⓢ** / **ENTER** to access the edit window.

For more information on the parametric equalizer and each parameter, see page 144.

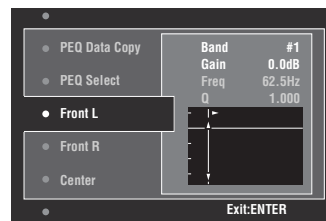

The parameter selected in "PARAM" is highlighted.

- Press **Ⓢ** / **⏪** / **⏩** / **⏴** / **⏵** to adjust the parameter.
- Press **Ⓢ** / **⏪** / **⏩** to adjust the "Gain".
- Press **Ⓢ** / **ENTER** to exit the edit window.



- When you select "Band" in step 3, you can use this menu as a graphic equalizer.
- "Band #5", "Band #6", and "Band #7" can adjust the frequencies of above 500 Hz.
- When you select "Subwoofer" in step 1 and "Band" in step 3, you can adjust "Band #1", "Band #2", "Band #3" and "Band #4" only. In this case, "Band #1", "Band #2", "Band #3" and "Band #4" adjust the frequencies of below 200 Hz.

5 Repeat steps 3 and 4 until you are satisfied with the results.



If you want to reset all “Parametric EQ” parameter settings for the selected speaker, select “RESET” and press **ⒺENTER**.

6 Select “EXIT” and press **ⒺENTER** to exit from the settings window.

■ Tone Control (Tone control)

Use this feature to adjust the balance of bass and treble output to your speakers or headphones.

Note

- Tone Control is not effective when:
- the PURE DIRECT mode (page 47) is selected.
 - MULTI CH is selected as the input source.

Control (Control mode)

Choice	Functions
Speaker	Adjust the bass/treble balance of your speakers.
Headphone	Adjust the bass/treble balance of your headphones.



“Speaker” and “Headphone” adjustments are stored independently. The adjustments for “Speaker” affects the front left/right, center, presence left/right speaker channels and Subwoofer channel.

Bass (Bass control)

Use this feature to adjust low-frequencies output to your speakers or headphones.

Choices: 125 Hz, **350 Hz**, 500 Hz

Control range: –6.0 dB to +6.0 dB

Initial setting: 0.0 dB

Treble (Treble control)

Use this feature to adjust high-frequencies output to your speakers or headphones.

Choices: 2.5 kHz, **3.5 kHz**, 8.0 kHz

Control range: –6.0 dB to +6.0 dB

Initial setting: 0.0 dB

Auto Bypass (Auto bypass)

Use this feature to select whether the audio output bypasses the tone control circuitry when “Treble” and “Bass” are set to 0 dB.

Choice	Functions
Auto	Automatically bypasses the tone control circuitry to provide the purest signal possible when “Treble” and “Bass” are set to 0 dB.
Off	Does not bypass the tone control circuitry.

■ Lipsync (Audio and video synchronization)

Mode (HDMI automatic lip sync mode)

If the video monitor is connected to the HDMI OUT jack of this unit and compatible with the automatic audio and video synchronization function (automatic lip sync), this unit adjusts the audio and video synchronization automatically. Use this feature to activate or deactivate the automatic lip sync.

Choice	Descriptions
Auto	Select this setting if the connected video monitor is compatible with the automatic lip sync. Use “Auto” to fine adjust the audio and video synchronization.
Manual	Select this setting if the video monitor is not compatible with the automatic lip sync or you do not want to use the automatic lip sync. Use “Manual” to adjust the audio and video synchronization.

Note

When “HDMI OUT SEL” is set to “OUT 1+2” and video monitors are connected to both the HDMI OUT 1 and HDMI OUT 2 jacks, the automatic lip sync function does not work even if “Auto” is selected.

Auto (Automatic audio delay adjustment)

Use this feature to make fine adjustments of the audio and video synchronization when you set “Mode” to “Auto”.

Control range: **0** to 240 ms

Control step: 1 ms



“Offset” indicates the difference between the value of the audio delay that this unit sets automatically and the value of the audio delay that you set in “Mode”. This unit stores the value of “Offset” and applies the value to other automatic lip sync compatible video monitors.

Manual (Manual audio delay adjustment)

Use this feature to adjust the delay of the sound output manually to synchronize audio with video images when you set “Mode” to “Manual”.

Control range: **0** to 240 ms

Control step: 1 ms

■ Pure Direct (Pure Direct)

Use this feature to select whether this unit outputs the video signals when this unit is in the PURE DIRECT mode.

Choice	Functions
Audio	Does not output video signals.
Audio + Video	Outputs video signals. For the better sound quality, this unit only activates the limited video features.

Note

You cannot use the GUI menu while this unit is in the PURE DIRECT mode even if “Pure Direct” is set to “Audio + Video”.

■ Channel Mute (Channel mute)

Use this feature to mute specific speaker channels.

Mode (Mode)

Use this feature to activate or deactivate the “Channel Mute” setting for each speaker.

Choice	Functions
Disable	Deactivates the “Channel Mute” function.
Enable	Activates the “Channel Mute” function.

Each speaker settings

Select whether this unit mutes each speaker channel when you set “Mode” to “Enable”.

Channel Mute	Speaker channel
Front L	Front left
Front R	Front right
Center	Center
Surround L	Surround left
Surround R	Surround right
Surround Back L	Surround back left
Surround Back R	Surround back right
Front Presence L	Front presence left speaker
Front Presence R	Front presence right speaker
Subwoofer	Subwoofer

Choice	Functions
Mute On	Mutes the selected speaker channel.
Mute Off	Does not mute the selected speaker channel.

Setup (Video)

Use this menu to adjust the video parameters.



You can reset the all parameters in “Video” to the initial factory settings by using “VIDEO” of “INITIALIZE” in “ADVANCED SETUP” (page 122).

■ Analog ▶ Analog (Analog-to-analog video conversion)

Use this feature to enable or disable the video conversion among the analog video jacks (VIDEO, S VIDEO, and COMPONENT VIDEO jacks).

Choice	Functions
Through	Disables the video conversion among the analog video jacks.
Conversion	Enables the video conversion among the analog video jacks.

Notes

- Analog-to-HDMI video conversion is always possible unless video signals are being input at the HDMI input jacks or 1080p-resolution analog video signals are being input.
- This unit does not convert 480 line video signals and 576 line video signals interchangeably.
- 480p-, 576p-, 1080i- and 720p-resolution video signals cannot be output at the S VIDEO and VIDEO MONITOR OUT jacks.
- The converted video signals are only output at the MONITOR OUT jacks. When recording a video source, you must make the same type of video connections between each component.
- When composite video or S-video signals from a VCR are converted into component video signals, the picture quality may suffer depending on your VCR.
- Unconventional signals input at the composite video or S-video jacks cannot be converted or may be output abnormally. In such cases, set “Analog ▶ Analog” to “Through”.

■ Analog ▶ HDMI (Analog-to-HDMI video signal processing)

Use this feature to select whether this unit processes the analog-to-HDMI video signals (input at VIDEO, S VIDEO, or COMPONENT VIDEO input jacks and output at HDMI OUT jacks).

Choice	Functions
Through	Select this setting when you do not want this unit to process the analog-to-HDMI video signals.
Processing	Select this setting when you want this unit to apply the video processing configured in “Processing” to the analog-to-HDMI video signals.

■ HDMI ▶ HDMI (HDMI-to-HDMI video signal processing)

Use this feature to select whether this unit processes the HDMI-to-HDMI video signals (input at HDMI input jacks and output at HDMI OUT jacks).

Choice	Functions
Through	Select this setting when you do not want this unit to process the HDMI-to-HDMI video signals.
Processing	Select this setting when you want this unit to apply the video processing configured in "Processing" to the HDMI-to-HDMI video signals.

■ Processing (HDMI video signal processing)

Use this feature to configure the resolution, aspect, and progressive re-processing settings for the video signals output at the HDMI OUT jacks.

Note

This feature is available only when "Analog ▶ HDMI" or "HDMI ▶ HDMI" is set to "Processing".

Resolution (HDMI video signal resolution)

Use this feature to enable or disable the upscaling of the analog-to-HDMI video signals and/or HDMI-to-HDMI video signals.

This unit up-scales the video signals as follows:

- 480i(576i) → 480p(576p)/720p/1080i/1080p
- 480p(576p) → 720p/1080i/1080p
- 720p → 1080i/1080p
- 1080i → 720p/1080p

Choice	Functions
Through	Does not up-scale any video signals.
480p (or 576p), 1080i, 720p, 1080p	Up-scales video signals to 480p or 576p, 1080i, 720p, or 1080p of resolution.

Aspect (HDMI aspect ratio)

Use this feature to select whether this unit converts the aspect ratio of the analog-to-HDMI video signals and/or HDMI-to-HDMI video signals.

Choice	Functions
Through	Does not make any adjustments to the aspect ratio for the HDMI video signal sources.
16:9 Normal	Displays video images with the aspect ratio of 4:3 on your video monitor with the aspect ratio of 16:9. Black stripes appear on the right and left sides as a result.
Smart Zoom	Fits video images with the aspect ratio of 4:3 to your video monitor with the aspect ratio of 16:9.

Notes

- If the aspect ratio of the input video source is other than 4:3, this unit automatically ignores the setting of "Aspect".
- When "Aspect" is set to "Smart Zoom", the video images of the edge of the video monitor are rather stretched.

Prog. Re-Processing (Progressive re-processing)

Use this feature to enable or disable the progressive re-processing of the analog-to-HDMI video signals and/or HDMI-to-HDMI video signals.

Choice	Functions
Off	Disables the progressive re-processing of the HDMI video signals.
On	Enables the progressive re-processing of the HDMI video signals.

Note

This setting is effective only for video signals of which resolution is 480p(576p), 720p, or 1080p.

Setup (HDMI)

Use this feature to set the HDMI functions or check the information about the video monitors connected to the HDMI OUT jacks.

■ Standby Through (Standby through)

Mode (Standby through mode)

Use this feature whether this unit allows the HDMI signals input at the HDMI IN jacks to pass through this unit when this unit is in the standby mode. You can also designate an HDMI IN jack and HDMI OUT jack(s) that accept the signals when "Mode" is set to "Fix" and this unit is in the standby mode.

Choice	Functions
Off	Disables the HDMI standby through feature. HDMI signals do not pass through this unit if this unit is in the standby mode.
Last	HDMI signals pass through this unit (only from the HDMI IN jack to the HDMI OUT jack(s) used when this unit is set to the standby mode) even when this unit is in the standby mode.
Fix	HDMI signals pass through this unit (from the HDMI IN jack specified in "Input" to the HDMI OUT jack(s) specified in "Output") even when this unit is in the standby mode.

Note

When "Mode" is set to "Last" or "Fix", the amount of power consumption in the standby mode increases.

Input (HDMI IN jack select)

Use this feature to select an HDMI IN jack that accepts HDMI signals when this unit is in the standby mode.

Note

This setting is available only when “Mode” is set to “Fix”.

Choice	HDMI IN jack
IN1	HDMI IN1 (BD/HD DVD) jack
IN2	HDMI IN2 (DVD) jack
IN3	HDMI IN3 (CBL/SAT) jack
IN4	HDMI IN4 (DVR) jack

Output (HDMI OUT jack select)

Use this feature to select HDMI OUT jack(s) that output HDMI signals when this unit is in the standby mode.

Note

This setting is available only when “Mode” is set to “Fix”.

Choice	HDMI IN jack
OUT1 + 2	HDMI OUT 1 and HDMI OUT 2 jacks
OUT1	HDMI OUT 1 jack
OUT2	HDMI OUT 2 jack

Audio Output (HDMI audio output)

Use this feature to select whether to play back HDMI audio signals on this unit or on another HDMI component connected to the HDMI OUT jacks on the rear panel of this unit.

Choice	Functions
Amp	Outputs HDMI audio signals at the speakers connected to this unit.
TV	Outputs HDMI audio signals at the speakers of the TV connected to this unit.
Amp + TV	Outputs HDMI audio signals at the speakers connected to this unit and speakers of the TV connected to this unit.



If “Audio Output” is set to “TV” or “Amp + TV”, available audio signals vary depending on the specification of the connected video monitor.

Control Monitor (Control monitor)

Use this feature to select the HDMI OUT jack at which HDMI control signals are output.

Choice	Functions
HDMI OUT1	Outputs HDMI control signals at the HDMI OUT 1 jack.
HDMI OUT2	Outputs HDMI control signals at the HDMI OUT 2 jack.

Monitor Info. (Monitor information)

Use this feature to check the information (interface and frequency for each video resolution) about the video monitors connected to the HDMI OUT 1 and HDMI OUT 2 jacks of this unit.



Press repeatedly to toggle between “OUT1” (information about the video monitor connected to the HDMI OUT 1 jack) and “OUT2” (information about the video monitor connected to the HDMI OUT 2 jack).

Setup (Network)

Use this menu to adjust the network parameters.

Note

In case you changed your network configuration, you may need to reconfigure the network settings.



You can reset the all parameters in “Network” to the initial factory settings by using “NETWORK” or “INITIALIZE” in “ADVANCED SETUP” (page 122).

Configuration (Network configurations)

Use this feature to view the network parameters (IP address, etc.) or to change them manually.

DHCP (DHCP setting)

Use this feature to select whether this unit can obtain the network parameters (IP address, subnet mask, default gateway, primary DNS server and secondary DNS server) from the DHCP server of the connected network.

Choice	Descriptions
On	Select this setting when this unit can obtain the network parameters from the DHCP server of the connected network.
Off	Select this setting when you set the network parameters manually.

IP Address (IP address)

Use this parameter to specify an IP address assigned to this unit. This value must not duplicate the one used for other devices in the target network.

Subnet Mask (Subnet mask)

Use this parameter to specify the subnet mask value assigned to this unit.



For most of the cases, the subnet mask value can be set as “255.255.255.0”.

Default Gateway (Default gateway)

Use this parameter to specify the IP address of the default gateway.

DNS Server (P) (Primary DNS server)

DNS Server (S) (Secondary DNS server)

Use this parameter to specify the IP address of the primary and secondary DNS (Domain Name System) servers.

Note

If you have only one DNS address, enter the DNS address in “DNS Server (P)”. If you have two or more DNS addresses, enter one of them in “DNS Server (P)” and another in “DNS Server (S)”.

Network Standby (Network standby)

Use this feature to select whether this unit accepts the commands via LAN network when this unit is in the standby mode.

Choice	Descriptions
Off	Does not accept the operations via LAN network when this unit is in the standby mode.
On	Accepts the operations via LAN network when this unit is in the standby mode.

Note

When “Network Standby” is set to “On”, the amount of power consumption in the standby mode increases.

Information (Network information)

Use this feature to display the network system information.

MAC Address

(MAC (Media Access Control) address)

This information displays the MAC address that is assigned to this unit.

Status (Network status)

This information displays the current link status of the network.

Display status: 10BASE-T, 100BASE-TX, No Link, Full Duplex, Half Duplex

Note

“No Link” appears when network connection is not made.

System (System ID)

This information displays the system ID that is assigned to this unit.

Setup (Multi Zone)

Use this menu to set the functions of the multi-zone configuration.

Zone SP Assign (Zone speaker assignment)

Use this feature to assign the speaker terminals for Zone 2 and Zone 3.

- Press F9 / Δ / ∇ to select the speaker terminal and then press F9 / \leftarrow / \rightarrow repeatedly to select the desired zone of which you want to use the speakers.

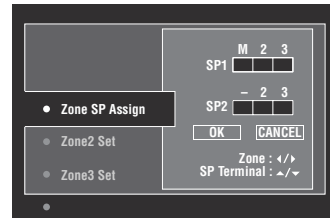

M : Main zone
2 : Zone 2
3 : Zone 3

- Press F9 / Δ / ∇ to select “OK” and then press F9 / **ENTER** to confirm the setting.



To return to the previous menu level without change, select “CANCEL” in step 2.

Zone2 Set/Zone3 Set (Zone 2/Zone 3 settings)

Zone2 Volume/Zone3 Volume (Zone 2/Zone 3 volume)

Use this menu to select whether this unit controls the volume level of the audio signals output at the ZONE OUT (ZONE 2 or ZONE 3) jacks.

Choice	Descriptions
Fixed	Select this setting when you want to control the volume level of the selected zone on the external amplifier. This unit fixes the ZONE OUT (ZONE 2 or ZONE 3) volume level to a standard line level.
Variable	Select this setting when you want to control the volume level of the selected zone on this unit. You can adjust the ZONE OUT (ZONE 2 or ZONE 3) volume level simultaneously with F9 / VOLUME +/- on the remote control.

Note

When “Zone2 Volume” or “Zone3 Volume” is set to “Fixed”, you cannot select the following parameters:

- Zone2 Max Vol./Zone3 Max Vol.
- Zone2 Initial Vol./Zone3 Initial Vol.

Zone2 Max Vol./Zone3 Max Vol. (Zone 2/Zone 3 Maximum volume setting)

Use this feature to set the maximum volume level in the Zone 2 or Zone 3.
Control range: –30.0 dB to +15.0 dB, **+16.5 dB**
Control step: 5.0 dB

Note

The “Zone2 Max Vol.” or “Zone3 Max Vol.” setting takes priority over the “Zone2 Initial Vol.” or “Zone3 Initial Vol.” setting.

Zone2 Initial Vol./Zone3 Initial Vol. (Zone 2/Zone 3 initial volume setting)

Use this feature to set the volume level of Zone 2 or Zone 3 when the power of each zone is turned on.
Control range: **Off**, Mute, –80.0 dB to +16.5 dB
Control step: 0.5 dB

Note

The “Zone2 Max Vol.” or “Zone3 Max Vol.” setting takes priority over the “Zone2 Initial Vol.” or “Zone3 Initial Vol.” setting.

Zone2 Balance/Zone3 Balance (Zone 2/Zone 3 balance)

Use this feature to adjust the balance of the volume of the left and right channels in each zone.
Choices: L10 to L1, **0**, R1 to R10

Zone2 Tone Control/Zone3 Tone Control (Zone 2/Zone 3 tone control)

Use this feature to adjust the balance of bass and treble output to the selected zone.
Choices: Bass (Bass control), Treble (Treble control)
Control range: –10.0 dB to +10.0 dB
Initial setting: 0.0 dB

Zone2 Muting Type/Zone3 Muting Type (Zone 2/Zone 3 muting type)

Use this feature to adjust how much the mute function reduces the output volume of the selected zone.

Choice	Functions
Full	Mutes all the audio output.
–20dB	Reduces the current volume by 20 dB.
–40dB	Reduces the current volume by 40 dB.

■ Zone OSD (Zone on-screen display)

Use this feature to display the operational status of Zone 2 and Zone 3 on the Zone 2 video monitor connected to the ZONE VIDEO jacks on the rear panel of this unit.

Choice	Functions
Off	Turns off the zone on-screen display feature.
Zone2	Displays the operational status of Zone 2 only.
All	Displays the operational status of Zone 2 and Zone 3.

■ Zone Rename (Zone Rename)

Main/Zone2/Zone3 (Main/ Zone 2/ Zone 3 rename)

Use this feature to edit the name of the selected zone.

1 Press **Ⓞ** **△** / **▽** / **◀** / **▶** to select a character or function and then press **Ⓞ** **ENTER** to confirm the selection.

Repeat step 1 until you input a name you want to use.

2 Press **Ⓞ** **△** / **▽** / **◀** / **▶** to select “OK” and then press **Ⓞ** **ENTER**.



- To reset the name, select “RESET” and then press **Ⓞ** **ENTER**.
- To cancel the operation without change, select “CANCEL” and then press **Ⓞ** **ENTER**.

Setup (Option)

This menu adjusts the optional system settings.

■ Memory Guard (Memory guard)

Use this feature to prevent accidental changes to sound field program parameter values and other system settings.

Choice	Functions
Off	Turns off the “Memory Guard” feature.
On	Protects the following parameters: <ul style="list-style-type: none"> – sound field program parameters – GUI menu parameters – speaker levels settings



When “Memory Guard” is set to “On”, “” appears on the left side of the name of a parameter being protected.

I/O Assignment (Input/output assignment)

Use this feature to assign the input/output jacks according to the component to be used if the initial settings of this unit do not correspond to your needs. Change the parameter to reassign the respective jacks and effectively connect more components.

Once the input/output jacks are reassigned, you can select the corresponding component by using the **INPUT** selector (or the input selector buttons (3)).

Example: Assigning the CD DIGITAL INPUT COAXIAL jack to “MD/CD-R”.

1 Press **ENTER** to display the “I/O Assignment” screen.

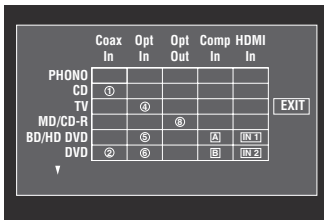

2 Press **△ / ▽ / ◀ / ▶** to select the cell in row “MD/CD-R”, column “Coax In” and then press **ENTER**.

3 Press **◀ / ▶** to select “①” and then press **ENTER**.

Select “None” to clear the existing assignment.



To return to the previous screen without change, press **△**.

4 Press **△ / ▽ / ◀ / ▶** to select “EXIT” and then press **ENTER**.



You cannot select a specific item more than once for the same type of jack.

Input Rename (Input rename)

Use this feature to change the name of the input source that appears in the GUI screen and in the front panel display.

1 Press **△ / ▽ / ◀ / ▶** to select a character or function and then press **ENTER** to confirm the selection.

Repeat step 1 until you input a name you want to use.

2 Press **△ / ▽ / ◀ / ▶** to select “OK” and then press **ENTER**.



- To reset the name, select “RESET” and then press **ENTER**.
- To cancel the operation without change, select “CANCEL” and then press **ENTER**.

Display Set (Display settings)

Front Panel Display (Front panel display setting)

Dimmer (Dimmer)

Use this feature to adjust the brightness of the front panel display.

Control range: -4 to 0

Scroll (Front panel display message scroll)

Use this feature to set the front panel display message scroll pattern.

Choice	Functions
Continue	Continuous mode. Select this to display the operation status in the front panel display in a continuous manner.
Once	Scroll-once mode. Select this to display the operation status in the front panel display by the first 14 alphanumeric characters after scrolling all characters once.

Short Message (Short message display)

Use this feature to activate or deactivate the short message display displayed in the GUI screen in the main zone.

Choice	Functions
On	Activates the short message display function.
Off	Deactivates the short message display function.

Note

The short message display (except some status messages) does not appear when the component video signals with 720p, 1080i or 1080p resolutions are input.

Playback Screen (Playback screen display time)

Use this feature to set the playback screen display time.

Choice	Functions
Always	Displays the menu unceasingly during an operation.
10sec	Turns off the menu 10 seconds after you perform a certain operation.
30sec	Turns off the menu 30 seconds after you perform a certain operation.



This setting is applied to the GUI screen in the main zone and OSD in Zone 2 or Zone 3.

Position (GUI screen position)

Use this feature to adjust the vertical and horizontal position of the GUI screen.

Control range: -5 (downward/left) to +5 (upward/right)

Button	Moving direction of the GUI display
Ⓞ Δ	Up
Ⓞ ▽	Down
Ⓞ ▷	Right
Ⓞ ◁	Left

Wall Paper (Wall paper)

Use this feature to display the wall paper or gray background in your video monitor when there is no video signal being input.

Choice	Functions
None	Does not display any background in your video monitor.
Piano	Displays a background image (the photograph of a piano) in your monitor when there is no video signal being input.
Horn	Displays a background image (the photograph of a horn) in your monitor when there is no video signal being input.
Electric Guitar	Displays a background image (the photograph of an electric guitar) in your monitor when there is no video signal being input.
Gray	Display a gray background in your monitor when there is no video signal being input.

■ iPod (iPod settings)

Standby Charge

(iPod charge on the standby mode)

Use this feature to select whether this unit charges the battery of the stationed iPod or not when this unit is in the standby mode.

Choice	Functions
Auto	Charges the battery of the stationed iPod when this unit is turned on and in the standby mode.
Off	Charges the battery of the stationed iPod only when this unit is turned on.

■ Initial Set (Initial settings)

Audio Select (Default audio input jack select)

Use this feature to designate the default audio input jack select setting (page 37) for the input sources connected to the DIGITAL INPUT jacks when you turn on the power of this unit.

Choice	Functions
Auto	Automatically detects the type of audio input signals and selects the appropriate audio input jack select setting.
Last	Automatically selects the last audio input jack select setting used for the connected input source.

Decoder Mode (Default decoder mode)

Use this feature to designate the default decoder mode (page 74) for the input sources when you turn on the power of this unit.

Choice	Functions
Auto	Automatically detects the type of input signals and select the appropriate decoder mode setting.
Last	Automatically selects the last decoder mode setting used for the connected input source.

EXTD Surround (Default extended surround decoder mode setting)

Use this feature to designate the extended surround decoder mode (page 75) for the input sources connected to the DIGITAL INPUT jacks when you turn on the power of this unit.

Choice	Functions
Auto	Automatically detects the input digital audio signals and activates the appropriate decoder.
Last	Selects the last selected extended surround decoder mode.

■ Trigger Output (Trigger output)

Use this feature to select the functions of each TRIGGER OUT jack of this unit.

Choice	Function
Trigger1	Sets the functions for the TRIGGER OUT 1 jack.
Trigger2	Sets the functions for the TRIGGER OUT 2 jack.

Trigger Mode (Trigger mode)

Choice	Descriptions
Power	Select this setting to send the voltage signals at the selected TRIGGER OUT jack while the selected zone is turned on.
Source	Select this setting to send the voltage signals at the selected TRIGGER OUT jack while the selected input source is selected.
Manual	Select this setting to send the voltage signals manually.

Target Zone (Target zone)

Note

This setting is not available when “Trigger Mode” is set to “Manual”.

Choice	Target zone
Main	Main zone
Zone2	Zone 2
Zone3	Zone 3
All	Main zone, Zone 2, and Zone 3

Input Level (Input level)

Select the input source and then set the input level applied to the selected input source.

Note

This setting is available only when “Trigger Mode” is set to “Source”.

Choice	Descriptions
High	Sends the voltage when the input source is selected.
Low	Stops sending the voltage when the input source is selected.

Manual Test (Manual test)

Note

This setting is available only when “Trigger Mode” is set to “Manual”.

Choice	Functions
High	Sends the voltage signals.
Low	Stops sending the voltage signals.

Language

Use this feature to select the language of the menu items and messages.

Choices: **English** (English), 日本語 (Japanese), Français (French), Deutsch (German), Español (Spanish), Русский (Russian)



You can also select the display language with the “LANGUAGE” parameter in “ADVANCED SETUP” (page 123).

Language	GUI menu	Front panel display	Zone OSD
Русский (Russian)	○	○	—
日本語 (Japanese)	○	—	—
Other languages	○	○	○

- ... The selected language is displayed.
- ... The selected language is not displayed. The menu items and messages are displayed in English.

Saving and recalling the system settings (System Memory)

Use this feature to save and recall up to six of your favorite setting for the main zone. You can also save up to four of your favorite settings for Zone 2 or Zone 3.

Saving the system settings

■ Saving by the ⑦ SYSTEM MEMORY buttons

You can save the system settings stored in “Memory1” to “Memory4” by pressing the corresponding ⑦ SYSTEM MEMORY buttons.

Press and hold one of the ⑦ SYSTEM MEMORY buttons on the remote control for 4 seconds.

“Memory1 SAVE” (example) appears in the front panel display, and then this unit saves the current system setting to the corresponding memory number.

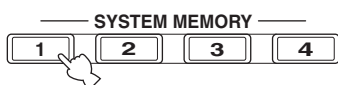

- If system settings are already stored in the selected memory number, this unit overwrites the old settings.
- To save the system settings for Zone 2 or Zone 3, press ⑧ ZONE on the remote control repeatedly to select the desired zone and then press and hold one of the ⑦ SYSTEM MEMORY buttons for 4 seconds. To save the system settings for the selected zone, the zone should be turned on.
- This unit saves the parameters in the groups you select by using the GUI menu when you save the parameters by using the ⑦ SYSTEM MEMORY buttons.

■ Saving by the GUI menu operation

You can save the current system settings stored in “Memory1” to “Memory6” by using the “System Memory” menu in the GUI menu.

- 1 Set the operation mode selector on the remote control to ⑩ AMP and then press ⑪ MENU.**



If the menu directory other than “Top Menu” (page 79) is displayed, press and hold ⑪ MENU to display the top GUI menu.

- 2 Press ⑨ Δ / ▽ repeatedly to select “Setup” and then press ⑨ ▷.**

- 3 Press ⑨ Δ / ▽ repeatedly to select “System Memory” and then press ⑨ ▷.**

- 4 Press ⑨ Δ / ▽ repeatedly to select the desired zone and then press ⑨ ▷.**

- 5 Press ⑨ Δ / ▽ repeatedly to select “xxx Save” and then press ⑨ ▷.**
“xxx” indicates the zone you selected in step 4.

- 6 Press ⑨ Δ / ▽ repeatedly to select the desired memory number and then press ⑨ ENTER.**

The list of the parameter groups to be saved appears. Available parameter groups vary depending on the selected zone.

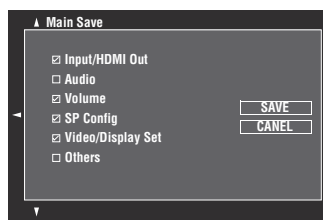

- If system settings are already stored in the selected memory number, this unit overwrites the old settings.
- To load the system settings with the ⑦ SYSTEM MEMORY button operation, use one of “Memory1” to “Memory4”.

- 7 Press ⑨ Δ / ▽ repeatedly to select the parameter group and then press ⑨ ENTER to check or uncheck the box.**

Check the boxes for the parameter groups to be saved. For details on parameters to be saved, see “Parameters to be saved” (page 102).

- 8 Press ⑨ Δ / ▽ / ◀ / ▶ repeatedly to select “SAVE” and then press ⑨ ENTER to save the current system settings to the selected memory number.**



To cancel the operation, select “CANCEL” and then press ⑨ ENTER.

- 9 Press ⑪ MENU to turn off the GUI menu.**

■ Renaming the stored settings

- 1** Follow steps 1 to 4 in “Saving by the GUI menu operation” (page 101).
- 2** Press **⓪** / **△** / **▽** repeatedly to select “xxx Rename” and then press **⓪** / **▷**.
“xxx” indicates the zone you selected in step 1.
- 3** Press **⓪** / **△** / **▽** repeatedly to select the desired memory number and then press **⓪** / **▷**.
- 4** Press **⓪** / **△** / **▽** / **◀** / **▶** to select a character or function and then press **⓪** / **ENTER** to confirm the selection.
Repeat step 4 until you input a name you want to use.
- 5** Press **⓪** / **△** / **▽** / **◀** / **▶** to select “OK” and then press **⓪** / **ENTER**.



- To reset the name, select “RESET” and then press **⓪** / **ENTER**.
- To cancel the operation without change, select “CANCEL” and then press **⓪** / **ENTER**.

- 6** Press **⓪** / **MENU** to turn off the GUI menu.

Note

If you change the language setting (page 100 or 123), names of the memory settings will be automatically reset.

■ Parameters to be saved

The parameter groups indicated in bold are selected by default.

Main zone parameters

Group	Parameters	Page
Input/HDMI Out	Audio Select	85
	Decoder Mode	85
	Input source	36
	HDMI OUT SEL	37

Group	Parameters	Page
Audio	Stereo/Surround	80
	PURE DIRECT on/off	47
	EXTD SUR. setting	75
	Adaptive DRC	89
	Adaptive DSP Level	89
	LFE Level	90
	Dynamic Range	90
	Tone Control	92
	Pure Direct	93
	CINEMA DSP 3D mode on/off	46
Volume	Volume level	36
SP Config	Parametric EQ	90
	Configuration	87
	Distance	88
	Level	89
	Information (Auto Setup)	34
	Setup Menu (Auto Setup)	30
Video/ Display Set	Analog ▶ Analog	93
	Analog ▶ HDMI	93
	HDMI ▶ HDMI	94
	Processing	94
	Short Message	98
	Playback Screen	98
	Position	99
	Wall Paper	99
	Others	Lipsync
Front Panel Display		98
Audio Output		95

Zone 2 and Zone 3 parameters

Parameter	Descriptions	Page
Input	Input source	120
Volume	Volume level	120
Tone Control	Tone control settings	120

Loading the system settings

Note

If you load the system settings, the settings currently configured are overwritten. If you do not want to erase the current settings, save the settings using the System Memory feature in advance.

■ Loading by the ⑦ SYSTEM MEMORY buttons

You can recall the system settings stored in “Memory1” to “Memory4” by pressing the corresponding ⑦ SYSTEM MEMORY buttons.

1 Press one of the ⑦ SYSTEM MEMORY buttons on the remote control to select the desired memory number.

“Memory1 LOAD” (example) appears in the front panel display.

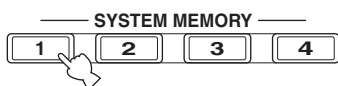

“Empty” appears in the menu screen if no system settings are stored in the selected memory number.

2 Press the selected ⑦ SYSTEM MEMORY button once more to confirm the selection.

This unit loads the settings stored in the selected memory number.

■ Loading by the GUI menu operation

1 Follow steps 1 to 4 in “Saving by the GUI menu operation” (page 101).

2 Press ⑨△/▽ repeatedly to select “xxx Load” and then press ⑨▷.

“xxx” indicates the zone you selected in step 1.

3 Press ⑨△/▽ repeatedly to select the desired memory number and then press ⑨▷.



If the memory number you selected is empty, “Memory Empty” appears.

4 Press ⑨ENTER to load the settings stored in the selected memory number.



To cancel the operation and return to the previous menu level, press ⑨◀.

5 Press ⑩MENU to turn off the GUI menu.

Using examples

■ Example 1: Comparing the results of the automatic setup and manual setup

This unit is equipped with three types of parametric equalizer settings (page 91), and you can also make your customized configuration of the sound settings of this unit by using the “Speaker” parameters (page 87). To compare the results of the automatic setup or your manual configuration, use the ⑦ SYSTEM MEMORY buttons.

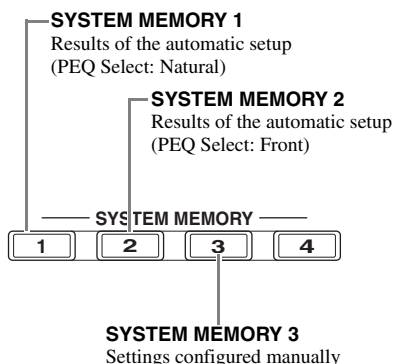

Saving each setting

1 Perform the automatic setup (page 30).

2 Press and hold ⑦ SYSTEM MEMORY 1 for 4 seconds.

This unit stores the results of the automatic setup (PEQ Select: Natural) to “Memory1”.

3 Set “PEQ Select” to “Front” (page 91).

4 Press and hold ⑦ SYSTEM MEMORY 2 for 4 seconds.

This unit stores the results of the automatic setup (PEQ Select: Front) to “Memory2”.

5 Configure the parameters of “Speaker” (page 87) and parametric equalizer configuration of each speaker manually (page 91).

6 Press and hold ⑦ SYSTEM MEMORY 3 for 4 seconds.

This unit stores the settings configured manually to “Memory3”.

■ **Example 2: Switching the settings for different room environments**

The tonal characteristics of the listening room may vary depending on the situations of the room (for example, whether the curtains are open or closed), and the settings of this unit should be arranged for each situation of the room. You can switch between the settings of this unit easily by using ⑦ **SYSTEM MEMORY** buttons.

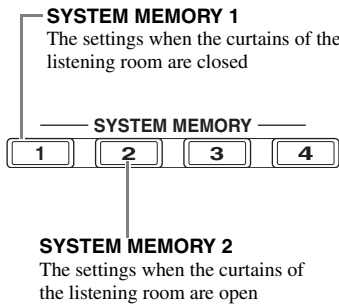

Saving each setting

-
- 1 Close the curtains of the listening room and then perform the automatic setup (page 30).**

 - 2 Press and hold ⑦ **SYSTEM MEMORY 1** for 4 seconds.**

This unit stores the settings for the current room situation (i.e. the curtains are closed) to “Memory1”.

 - 3 Open the curtains of the listening room and the perform the automatic setup.**

 - 4 Press and hold ⑦ **SYSTEM MEMORY 2** for 4 seconds.**

This unit stores the current room situation (i.e. the curtains are open) to “Memory2”.

Controlling this unit by using the Web browser (Web Control Center)

You can operate this unit by using a Web browser. You can select the input source and sound field program, browse the iPod or USB/network contents, select the preset items, and adjust the parameters of this unit by using the graphical user interface (Web Control Center) that appears in the Web browser. Check the IP address of this unit by using "IP Address" in "Network" menu (page 95) in advance, and then enter the IP address to the Web browser to access this unit to control it.

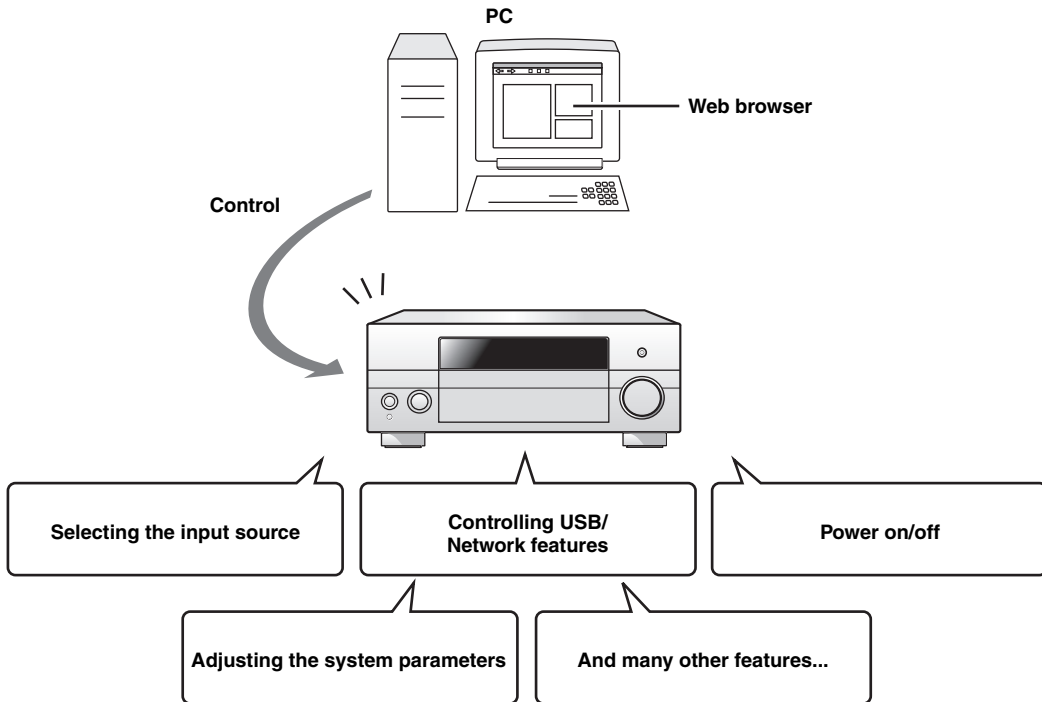

- ☼ To use this feature, this unit and your PC must be connected properly in the network (page 23).
- We recommend that you use Windows Internet Explorer 6 or 7 that is installed on Windows XP or Windows Vista PC to access this unit.
- You can select whether this unit accepts the controls by using the Web browser when this unit is in the standby mode (page 96).
- You can register the MAC address of the PCs you want to use to control this unit and limit the PCs that can control this unit by using the Web browser. You can select that this unit allows the access to this unit by the PCs whose MAC addresses are registered to this unit or allows the access by any PCs by using "MAC FILTER" in "ADVANCED SETUP" (page 122)

Remote control features

In addition to controlling this unit, the remote control can also operate other audiovisual components made by Yamaha and other manufacturers. To control your TV or other components, you must set up the appropriate remote control code for each input source (page 109).

Controlling this unit, a TV, or other components

■ Controlling this unit

Set the operation mode selector to **16AMP** to control this unit.

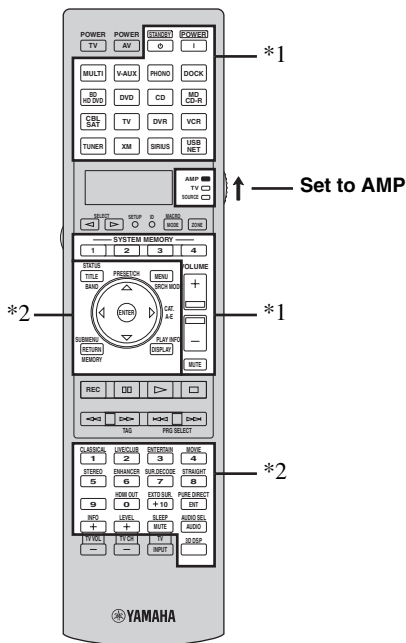

Notes

- *1 These buttons always control this unit regardless of the operation mode selector position.
- *2 These buttons control this unit only when the component operation mode selector is set to **16AMP**.

■ Controlling a TV

Set the operation mode selector to **16TV** to control your TV. To control your TV, you must set the appropriate remote control code for the TV operation mode in advance (page 109).



If no code has been set for the TV operation mode, the remote control operates the component that is set to the TV control area (page 109).

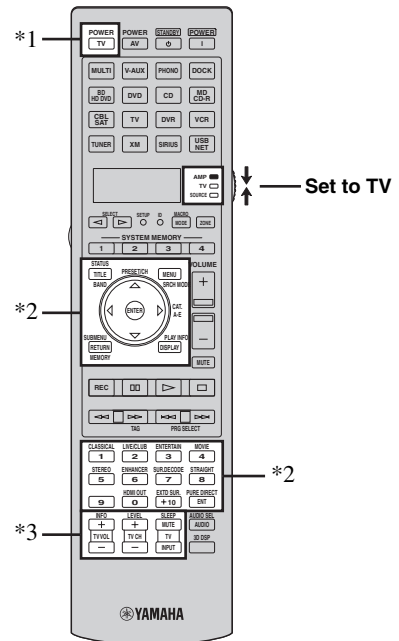

Notes

- *1 **16TV POWER** can always turn on or off the power of the TV regardless of the operation mode selector position.
- *2 These buttons control your TV only when the operation mode selector is set to **16TV**. For details, see the “TV” column on page 107.
- *3 These buttons control your TV only when the operation mode selector is set to **16TV** or **16SOURCE**.

Remote control	Functions
TV VOL +/-	Increases or decreases the volume level.
TV CH +/-	Changes the TV channel.
TV MUTE	Mutes the audio output.
TV INPUT	Changes the input source.

Controlling other components

Set the operation mode selector to **16 SOURCE** to control other components selected with the input selector buttons (3). You must set the appropriate remote control code for each input source in advance (page 109). The following table shows the function of each control button used to control other components assigned to each input selector button (3). Be advised that some buttons may not correctly operate the selected component.



The remote control has 16 modes (input areas) to control components so that the remote control can operate up to 16 different components.

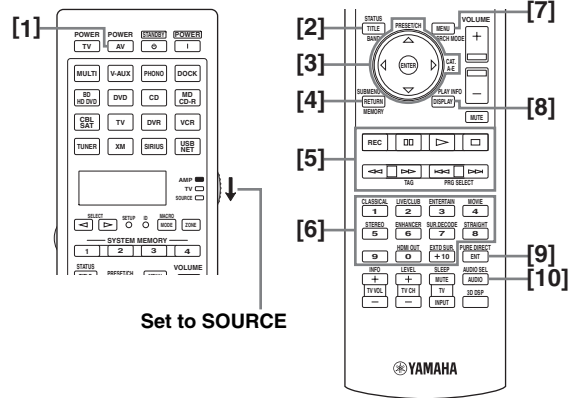

	Blu-ray Disc/ HD DVD player/ recorder	DVD player	LD player	DVD recorder/ Digital video recorder	VCR	TV	Cable TV/ Satellite tuner	CD player	MD recorder/ CD recorder	Tape deck	Tuner
[1] AV POWER	Power *1	Power *1	Power *1	Power *1	Power *1	DVR power *2	Power *1	Power *1	Power *1	Power *1	Power *1
[2] TITLE, BAND	Title	Title		Title		Title					Band
[3] PRESET/ CH Δ	Menu up	Menu up		Menu up	Channel up	Menu up	Channel up				Menu up
PRESET/ CH ∇	Menu down	Menu down		Menu down	Channel down	Menu down	Channel down				Menu down
CAT. A-E Δ	Menu left	Menu left		Menu left		Menu left					Menu left
CAT. A-E ∇	Menu right	Menu right		Menu right		Menu right				Direction A/B	Menu right
ENTER	Menu enter	Menu enter		Menu enter		Menu enter					Menu enter
[4] RETURN, MEMORY	Return	Return		Return		Return					Memory
[5] REC	Record (recorder)	Disc skip		Record	Record	DVR record *2	DVR record *2	Disc skip	Record	Record	
⏸	Pause	Pause	Pause	Pause	Pause	DVR pause *2	DVR pause *2	Pause	Pause	Pause	
▶	Play	Play	Play	Play	Play	DVR play *2	DVR play *2	Play	Play	Play	
⏹	Stop	Stop	Stop	Stop	Stop	DVR stop *2	DVR stop *2	Stop	Stop	Stop	
◀◀	Search backward	Search backward	Search backward	Search backward	Search backward	DVR search backward *2	DVR search backward *2	Search backward	Search backward	Search backward	
▶▶	Search forward	Search forward	Search forward	Search forward	Search forward	DVR search forward *2	DVR search forward *2	Search forward	Search forward	Search forward	
⏮	Skip backward	Skip backward	Skip backward	Skip backward	Skip backward	DVR skip backward *2	DVR skip backward *2	Skip backward	Skip backward	Direction A	Audio program down *3
⏭	Skip forward	Skip forward	Skip forward	Skip forward	Skip forward	DVR skip forward *2	DVR skip forward *2	Skip forward	Skip forward	Direction B	Audio program up *3
[6] 1-9, 0, +10	Numeric buttons	Numeric buttons	Numeric buttons	Numeric buttons	Numeric buttons	Numeric buttons	Numeric buttons	Numeric buttons	Numeric buttons	Numeric buttons	Numeric buttons
[7] MENU, SRCH MODE	Menu	Menu		Menu		Menu					Search mode
[8] DISPLAY	Display	Display	Display	Display	Display	Display	Display	Display	Display	Display	Display
[9] ENT	Index	Index	Chapter/ time	Index	Enter	Enter	Enter	Index	Index	Index	Enter
[10] AUDIO	Audio	Audio	Audio	Audio							

Notes

*1 This button is operational only when the original remote control supplied with the component has a power button.

*2 These buttons operate your video recorder (DVD recorder, etc.) only when you set the appropriate remote control code for DVR (page 109).

*3 These functions are used for selecting HD Radio audio programs (U.S.A. model only).

■ Selecting a component to be controlled

You can select a component to be controlled independently of the input source selected with the input selector buttons (③).

Press ⑤ **SELECT** </> repeatedly to select the desired component.

The name of the component to be controlled appears in the display window (④) on the remote control.



■ Controlling optional components (Option mode)

“OPTN1” and “OPTN2” are optional component control areas that can be programmed with remote control functions independently from any input source. These areas are useful for programming commands that are to be used only as a part of a macro function or for components that do not have a valid remote control code.

To select the option mode, press ⑤ **SELECT** </> repeatedly until “OPTN1” or “OPTN2” appears in the display window (④) on the remote control.

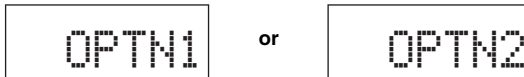

Note

You cannot set a remote control code for the optional areas. See page 111 to program buttons operated within this component control area.

Customizing the remote control

Use the setup mode of the remote control to customize the remote control.

1 Press ⑰ **SETUP** on the remote control using a ballpoint pen or similar object.

“SETUP” appears in the display window on the remote control.

2 Press ⑨ Δ / ∇ repeatedly to select the desired setup mode.

Setup mode	Descriptions	Page
SETUP	Top setup mode menu.	—
LEARN	Learning mode. Use this feature to program codes from other remote controls.	111
P-SET	Preset mode. Use this feature to change the remote control code of each control area.	109
RNAME	Renaming mode. Use this feature to change the name of each control area.	112
MACRO	Macro programming mode. Use this feature to set the macro program.	113
CLEAR	Clearing mode. Use this feature to clear the configurations of this unit.	115
ERASE	Erase mode. Use this feature to erase the learned functions of each button.	115
EX-IR	Extended IR code mode. This feature is for the authorized custom installers only.	—
LIGHT	Backlight mode. Use this feature to set the light up mode of the remote control.	109

3 After the configurations, press ⑰ **SETUP** again to exit from the setup menu.

Note

If you do not complete each of the operations within 30 seconds, this unit automatically exits from the setup menu.

Setting the backlight mode of the remote control

- 1 Press **17** **SETUP** on the remote control using a ballpoint pen or similar object.

“SETUP” appears in the display window (4) on the remote control.

- 2 Press **9** **Δ** / **∇** repeatedly to select “LIGHT” and then press **9** **ENTER**.

“LIGHT” and the current “LIGHT” setting appears in the display window (4) alternately.



- 3 Press **9** **Δ** / **∇** to select the desired setting and then press **9** **ENTER**.

Choice	Descriptions
ON	Lights up the backlight when a button is pressed.
OFF	Lights up the backlight only when 6 LIGHT is pressed.

- 4 Press **17** **SETUP** again to exit from the setup mode.

Setting remote control codes

You can control other components by setting the appropriate remote control codes. Codes can be set up for each input area. For a complete list of available remote control codes, refer to “List of remote control codes” at the end of this manual.

The following table shows the default component (Library: component category) and the remote control code for each control area.

Remote control code default settings

Control area	Library (component category)	Manufacturer	Default code
MULTI	DVD	Yamaha	04306
V-AUX	—	—	—
PHONO	—	—	—
DOCK	SOURCE	Yamaha	00012
BD HD DVD	BD	Yamaha	04706
DVD	DVD	Yamaha	04306
CD	CD	Yamaha	01205
MD CD-R	CD-R	Yamaha	01405
CBL SAT	—	—	—
TV	—	—	—
DVR	DVR	Yamaha	00707
VCR	—	—	—
TUNER	SOURCE	Yamaha	00012
XM	SOURCE	Yamaha	00012
SIRIUS	SOURCE	Yamaha	00012
USB NET	SOURCE	Yamaha	00012

Note

You may not be able to operate your Yamaha component even if a Yamaha remote control code is preset as listed above. In this case, try setting another Yamaha remote control code.

- 1 Check the remote control code for your component in advance.

For a complete list of available remote control codes, see “List of remote control codes” at the end of this manual.

- 2 Set the operation mode selector on the remote control to **16** **SOURCE**.

If you want to set the remote control code for “TV”, set the operation mode selector to **16** **TV**.

3 Press **17** **SETUP** using a ballpoint pen or similar object.

“SETUP” appears in the display window (4) on the remote control.



4 Press **9** **Δ** / **∇** repeatedly to select “P-SET” and then press **9** **ENTER**.

The remote control enters the preset mode. “P-SET” and name of the currently selected control area appears in the display window (4) alternately.



5 Press an input selector button (3) or **5** **SELECT** **</>** repeatedly to select the control area you want to customize.

If you selected “TV” in step 2, skip this step.



6 Press **9** **ENTER**.

The current code setting appears.

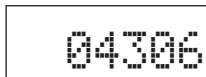

7 Press the numeric buttons (12) to enter the five-digit remote control code for your component.

8 Press **9** **ENTER** to set the number.

“OK” appears in the display window (4) if setting was successful.

“NG” appears in the display window (4) if the setting was unsuccessful. In this case, start over from step 5.



If you continuously want to set up another code for another control area, repeat steps 5 through 8.

10 Press **2** **AV POWER** or **11** **>** to confirm whether you can control your component using the remote control.



- If operation is not possible and the manufacturer of your component has more than one code, try each of them until you find the correct one.
- If you set “00012” as the remote control code of the selected control area, you can operate the currently selected internal source (DOCK, TUNER, XM, SIRIUS, or USB/NET).

Notes

- “ERROR” appears in the display window (4) on the remote control if you press a button not indicated in the respective step, or when you press more than one button simultaneously.
- The supplied remote control does not contain all possible codes for commercially available audio and video components (including Yamaha components). If operation is not possible with any of the remote control codes, program the new remote control function using the learning feature (page 111) or use the remote control supplied with the component.
- Functions programmed using the learning mode take priority over remote control code functions.

9 Press **17** **SETUP** again to exit from the setup menu.

Programming codes from other remote controls

You can program remote control codes from other remote controls. Use the learning feature if you want to program functions not included in the basic operations covered by the remote control codes, or an appropriate remote control code is not available. You can program the function of other remote control to the buttons in the highlighted areas in the following illustration. The buttons can be programmed independently for each control area.

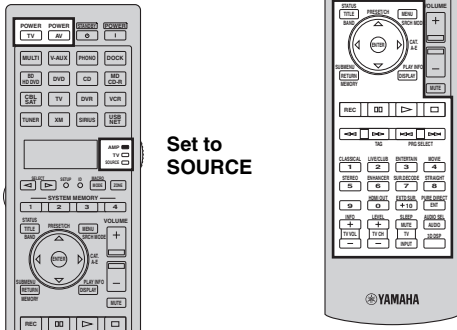

Set to
SOURCE

Notes

- The remote control transmits infrared rays. If the other remote control also uses infrared rays, this remote control can learn most of its functions. However, you may not be able to program some special signals or extremely long transmissions.
- You cannot program the desired remote control code even if you select the buttons in the highlighted area in the above illustration depending on the selected control area and the assigned library.

- Set the operation mode selector to **16 SOURCE** and then press an input selector button **3** to select the desired control area. If you want to program the remote control code for "TV", set the operation mode selector to **16 TV**.

Note

Make sure that the operation mode selector is set to **16 SOURCE** or **16 TV**. When you set the operation mode selector to **16 AMP** and program a remote control codes from other remote controls, the programmed key cannot operate the amplifier function of this unit.

- Press **17 SETUP** using a ballpoint pen or similar object. "SETUP" appears in the display window **4**.

- Press **9** Δ / ∇ repeatedly to select "LEARN" and then press **9** **ENTER**.

- Place this remote control about 5 to 10 cm (2 to 4 in) apart from the other remote control on a flat surface so that their infrared transmitters are aimed at each other and then press **9** **ENTER**.

"L-KEY" appears in the display window **4**.

Other remote control

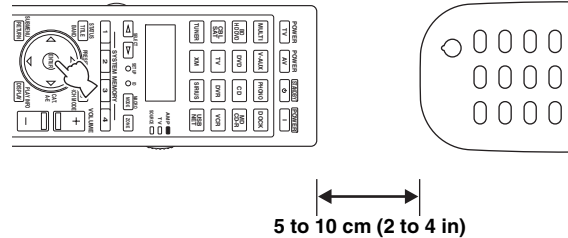

5 to 10 cm (2 to 4 in)

- Press the button for which you want to program the new function.

"START" appears in the display window **4**.

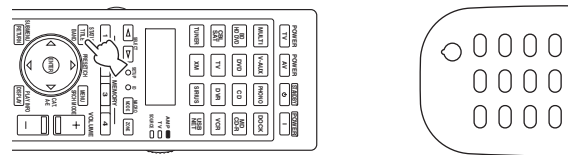

- Press and hold the button you want to program on the other remote control until "OK" appears in the display window **4**.

"NG" appears in the display window **4** if learning was unsuccessful. In this case, start over from step 4.

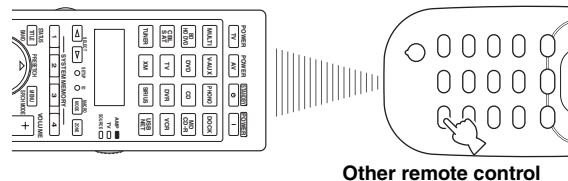

Other remote control

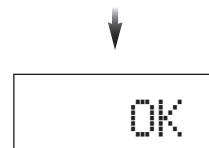

When you want to program another function, repeat steps 4 through 6.

7 Press **Ⓣ** **SETUP** again to exit from the setup menu.

Notes

- “ERROR” appears in the display window (④) on the remote control if you press a button not indicated in the respective step, or when you press more than one button simultaneously.
- This remote control can learn approximately 200 functions. However, depending on the signals learned, “FULL” may appear in the display before you program 200 functions. In this case, clear unnecessary programmed functions to make room for further learning (page 115).
- Learning may not be possible in the following cases:
 - when the batteries in the remote control for this unit or other components are weak.
 - when the remote control is exposed to direct sunlight.
 - when the function to be programmed is continuous or uncommon.

Changing source names in the display window

You can change the name of the control area (input source) that appears in the display window (④) on the remote control.

1 Set the operation mode selector to **Ⓟ** **SOURCE** and then press an input selector button (③) to select the desired control area.

2 Press **Ⓣ** **SETUP** using a ballpoint pen or similar object.

“SETUP” appears in the display window.

3 Press **Ⓟ** **Δ** / **∇** repeatedly to select “RNAME” and then press **Ⓟ** **ENTER**.

4 Press **Ⓟ** **Δ** / **∇** repeatedly to select 3-letter name or 5-letter name you want to edit and then press **Ⓟ** **ENTER**.

Each control area has both 3-letter name and 5-letter name. You can rename the 3-letter name and 5-letter name independently.

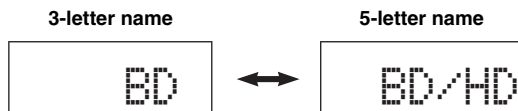

5 Edit the name of the control area.

To locate the position to edit, press **Ⓟ** **<** / **>**.

To select a character, press **Ⓟ** **Δ** / **∇**.



Press **Ⓟ** **Δ** to change the character in the following order, or press **Ⓟ** **∇** to go in the reverse order: A to Z, a to z, 0 to 9, space, symbols (–, +, /, :).

6 Press **Ⓟ** **ENTER** to set the new name.

“OK” appears in the display window (④) on the remote control if renaming was successful.



When you want to rename the another control area, press the input selector button (③) or **Ⓟ** **SELECT** **<** / **>** repeatedly to select the desired control area and then press **Ⓟ** **ENTER** and then carry out the operations of steps 4 through 6.

7 Press **Ⓣ** **SETUP** again to exit from the setup menu.

Note

“ERROR” appears in the display window (④) on the remote control if you press a button not indicated in the respective step, or when you press more than one button simultaneously.

Macro programming features

The macro programming feature makes it possible to perform a series of operations with the press of a single button. For example, when you want to play a CD, normally you would turn on the components, select the CD input, and press the play button to start playback. The macro programming feature lets you perform all of these operations simply by pressing the CD macro button. The buttons listed as macro buttons below are factory set with macro programs. You can also program your own macros (page 114).

Recalling programmed macro-operations

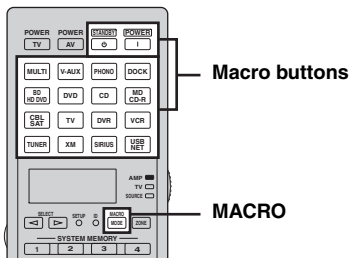

1 Press **18** **MACRO** on the remote control.



2 Press the desired macro button.

“M:the 3-letter name of the selected control area” (for example, “M:DVD”) appears in the display window (4), and this unit transmits the programmed functions. When you press **14** **STANDBY** or **15** **POWER**, “M:STB” or “M:PWR” appears in the display window (4), and this unit transmits the programmed functions.

3 Press **18** **MACRO** again to exit from the macro-operation mode.

Notes

- While the remote control is running a macro program (the transmission indicator flashes), it does not accept any other operation.
- Continue to aim the remote control at the component the macro is operating until the macro operation is complete.
- If you do not complete each of the operations within 30 seconds, this unit automatically exits from the macro-operation mode.

Default macro functions

Pressing macro button	To automatically transmit these signals in order	
	First	Second
STANDBY ⏻	STANDBY ⏻	—
POWER I		POWER (*1) TV
MULTI		MULTI
V-AUX		V-AUX
PHONO		PHONO
DOCK		DOCK
BD HD DVD		BD HD DVD
DVD		DVD
CD		CD
MD CD-R	(POWER) I	MD CD-R
CBL SAT		CBL SAT
TV		TV
DVR		DVR
VCR		VCR
TUNER		TUNER (*2)
XM		XM (*2)
SIRIUS		SIRIUS (*2)
USB NET		USB NET (*2)

*1 Set the appropriate remote control code for TV in advance (page 109).

*2 This unit plays the last received station or selected contents before the unit was set in the standby mode.

■ Programming macro operations

You can program your own macro to transmit several remote control commands in sequence at the press of a button. Be sure to set up remote control codes or perform learning operations before programming the macro.

Notes

- The default macro is not cleared when a new macro is programmed for a button. The default macro can be used again when the programmed macro is cleared.
- It is not possible to add a new signal (macro step) to the default macro. Programming a macro changes all macro contents.
- We do not recommend that you program continuous operations (for example, volume control) in a macro.

1 Press **17** **SETUP** using a ballpoint pen or similar object.

“SETUP” appears in the display window (4).

2 Press **9** **Δ** / **∇** repeatedly to select “MACRO” and then press **9** **ENTER**.

3 Press the desired macro button you want to assign the macro program to and then press **9** **ENTER**.

“M:the three-letter name of the selected macro button” (for example, “M:DVD”) and the name of the currently selected control area appears in the display window (4) alternately.

When you press **14** **STANDBY** or **15** **POWER**, “M:STB” or “M:PWR” and the name of the currently selected control area appears in the display window (4) alternately.

4 Press the buttons for the functions you want to include in the macro operation in sequence.

Example

Set the input source to DVD → Turn on the DVD player → Turn on the video monitor

Step 1 (“MCR1”): Press DVD.

Step 2 (“MCR2”): Press AV POWER.

Step 3 (“MCR3”): Press TV POWER.

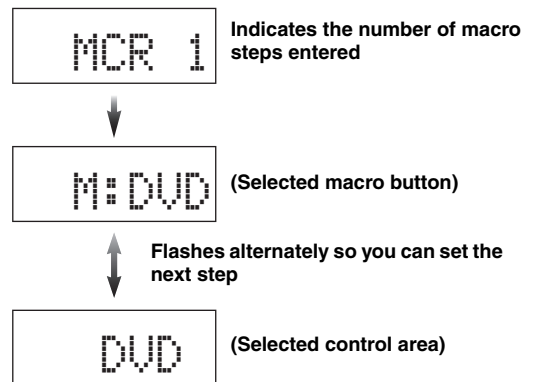
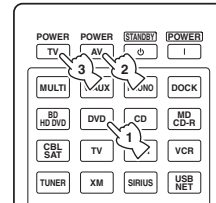

Notes

- To change the selected input area, press **5** **SELECT** **</>**. Pressing the input selector buttons will program a macro step, whereas **5** **SELECT** **</>** only changes the selected input area.
- The position of the operation mode selector (AMP/TV/SOURCE) affects the assigned function. When the operation mode selector is set to **16** **AMP** or **16** **TV**, the input source selectors do not function.

5 Press **18** **MACRO** to confirm the program.

You can set up to 10 steps (10 functions). After you have set 10 steps, “FULL” appears and the remote control automatically exits from the macro programming mode.

6 Press **17** **SETUP** again to exit from the setup menu.

Note

“ERROR” appears in the display window (4) if you press more than one button simultaneously.

Clearing configurations

You can clear all changes made in each function set, such as learned functions, macros, renamed control area names and setup remote control ID.

■ Clearing function sets

1 Press $\text{\textcircled{17}}$ **SETUP using a ballpoint pen or similar object.**

“SETUP” appears in the display window $\text{\textcircled{4}}$.

2 Press $\text{\textcircled{9}}$ Δ / ∇ repeatedly to select “CLEAR” and then press $\text{\textcircled{9}}$ **ENTER.**

3 Press $\text{\textcircled{9}}$ Δ / ∇ repeatedly to select the desired clear mode.

Clear mode	Descriptions
L:DVD (etc.)	(L:Three-digit name of the selected control area) Clears all learned functions the respective control area. You can change the control area to be cleared by pressing the desired input selector button $\text{\textcircled{3}}$ or $\text{\textcircled{6}}$ SELECT \triangleleft / \triangleright repeatedly.
L:AMP	Sets all learned functions for controlling the amplifier functions to the initial factory settings. Set the operation mode selector to $\text{\textcircled{16}}$ AMP to select this clear mode.
L:TV	Clears all learned functions for TV control area. Set the operation mode selector to $\text{\textcircled{16}}$ TV to select this clear mode.
L:ALL	Clears all learned functions.
M:DVD (etc.)	(M:Name of the selected macro button) Clears the macro programmed for the selected macro button (page 114). The assigned macro to the selected macro button reverts to the initial factory macro. Press the desired macro button if you want to change the macro button you want to clear the programmed functions of.
M:ALL	Clears all programmed macros. The assigned macro to the selected macro button reverts to the initial factory macro.
RNAME	Set all the name of the control areas to the default settings.
FCTRY	Set all settings of the remote control to the initial factory settings.

4 Press and hold $\text{\textcircled{9}}$ **ENTER for about 3 seconds.**

When the clearing is successful, “OK” appears in the display window $\text{\textcircled{4}}$.

Notes

- “NG” appears in the display window $\text{\textcircled{4}}$ if clearing was unsuccessful.
- “ERROR” appears in the display window $\text{\textcircled{4}}$ if you press a button not indicated in the respective step, or if you press more than one button simultaneously.

5 Press $\text{\textcircled{17}}$ **SETUP again to exit from the setup mode.**

■ Clearing a learned function

1 Press $\text{\textcircled{17}}$ **SETUP using a ballpoint pen or similar object.**

“SETUP” appears in the display window $\text{\textcircled{4}}$.

2 Press $\text{\textcircled{9}}$ Δ / ∇ repeatedly to select “ERASE” and then press $\text{\textcircled{9}}$ **ENTER.**

3 Set the operation mode selector to $\text{\textcircled{16}}$ **SOURCE and then press an input selector button $\text{\textcircled{3}}$.**

If you want to erase the function learned in the AMP or TV control area, set the operation mode selector to $\text{\textcircled{16}}$ **AMP** or $\text{\textcircled{16}}$ **TV**.

4 Press $\text{\textcircled{9}}$ **ENTER.**

“E-KEY” appears in the display window $\text{\textcircled{4}}$.

5 Press and hold the button you want to clear for about 3 seconds.

If clearing is successful, “OK” appears in the display window $\text{\textcircled{4}}$.



- If you continuously want to clear another function, repeat step 3 through 5.
- Once you clear a learned function, the button reverts to the factory setting (or to the manufacturer setting if you have set remote control codes).

6 Press $\text{\textcircled{17}}$ **SETUP again to exit from the setup menu.**

Notes

- “NG” appears in the display window $\text{\textcircled{4}}$ on the remote control if clearing was unsuccessful.
- “ERROR” appears in the display window $\text{\textcircled{4}}$ if you press more than one button simultaneously.

Simplified remote control

Use the supplied simplified remote control to make basic controls of this unit.

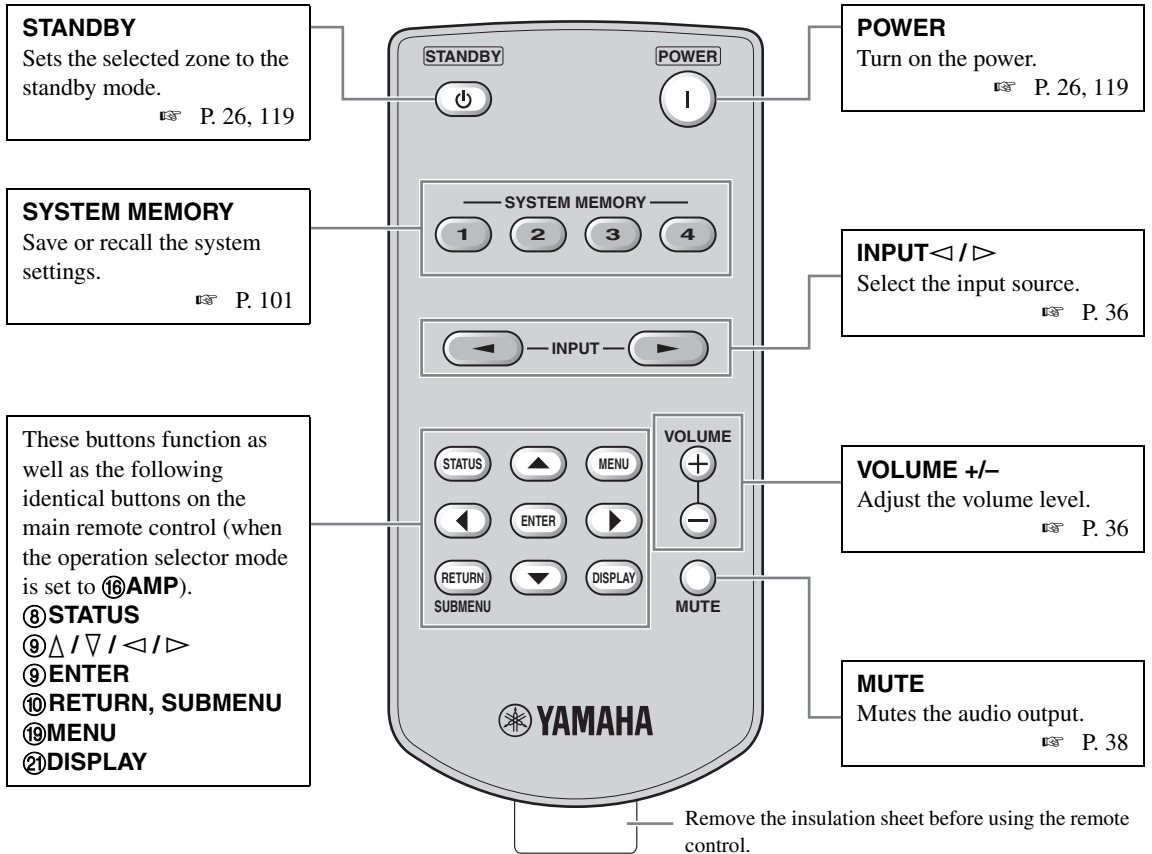

■ Setting the controlling zone of the simplified remote control

Use this feature to set the controlling zone (page 119) and remote control ID (page 121) of the simplified remote control.

Setting the remote control ID

- ID1: Press and hold ◀ (left cursor) and 1 for 3 seconds.
- ID2: Press and hold ◀ (left cursor) and 2 for 3 seconds.

Setting the controlling zone

- Main zone: Press and hold ▶ (right cursor) and 1 for 3 seconds.
- Zone 2: Press and hold ▶ (right cursor) and 2 for 3 seconds.
- Zone 3: Press and hold ▶ (right cursor) and 3 for 3 seconds.

■ Replacing the battery in the simplified remote control

Change the battery when the operation range of the simplified remote control decreases.

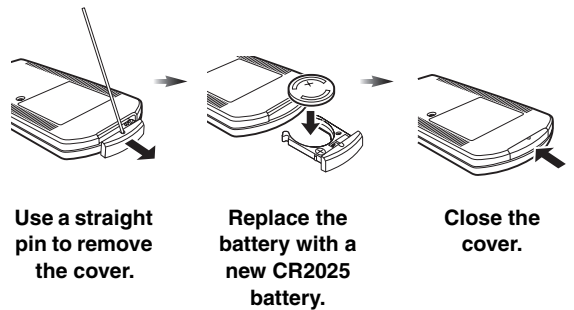

Notes

- Insert the battery according to the polarity markings (+ and -).
- If the batteries run out, immediately remove them from the simplified remote control to prevent an explosion or acid leak.
- If a battery starts leaking, dispose of it immediately. Be careful not to let the leaking battery acid touch your skin or clothing.
- Before inserting new batteries, wipe the compartment clean.
- Dispose of batteries according to your regional regulations.

Using multi-zone configuration

This unit allows you to configure a multi-zone audio system. The multi-zone configuration feature enables you to set this unit to reproduce separate input sources in the main zone, second zone (Zone 2) and third zone (Zone 3). You can control this unit from the second or third zone using the supplied remote control.

Only analog signals are sent to the second and third zones. Any source you want to listen to in the second zone and third zone must be connected to the analog AUDIO IN jacks of this unit.

Connecting the Zone 2 and Zone 3 components

You need the following additional equipment to use the multi-zone functions of this unit:

- An infrared signal receiver in the second zone and/or third zone.
- An infrared signal emitter in the main zone. This emitter transmits the infrared signals from the remote control via the infrared signal receiver in the second zone and/or third zone to a CD player or a DVD player, etc. in the main zone.
- An amplifier and speakers in the second zone and/or third zone.
- A video monitor for the second room.



- Since there are many possible ways to connect and use this unit in a multi-zone configuration, we recommend that you consult with your nearest authorized Yamaha dealer or service center about the Zone 2 and Zone 3 connections that best meet your requirements.
- Some Yamaha models are able to connect directly to the REMOTE jacks of this unit. If you own these products, you may not need to use an infrared signal emitter. Up to 6 Yamaha components can be connected as shown below.

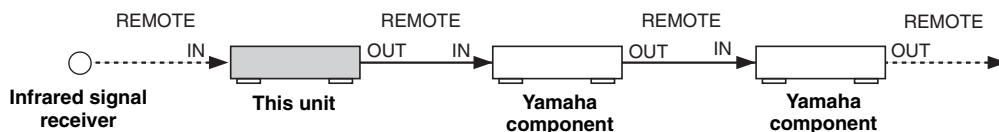

Using external amplifiers

To use an external amplifier in the second zone and/or third zone, connect the external amplifier to ZONE OUT jacks with analog audio cables

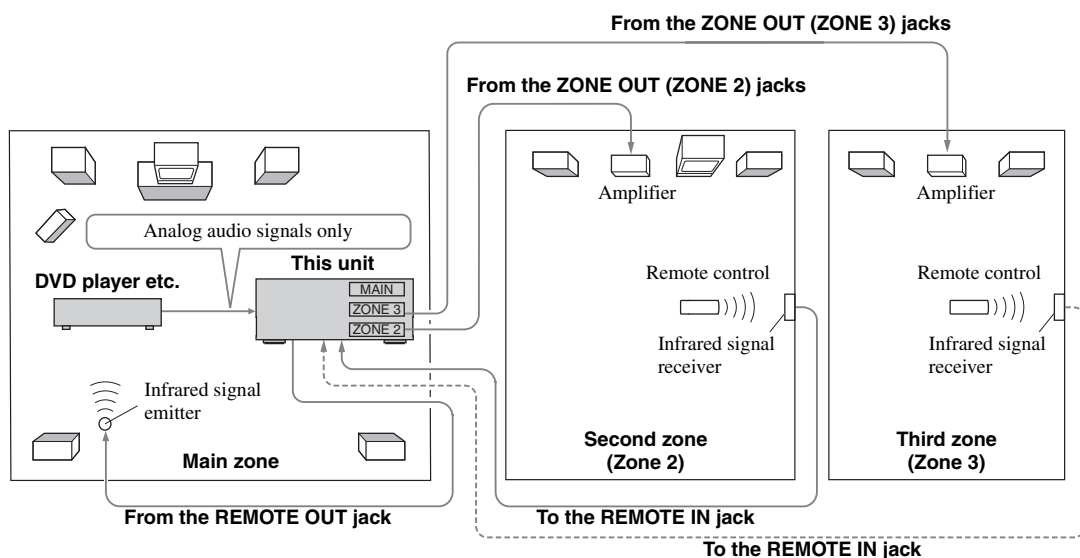

Notes

- To avoid unexpected noise, DO NOT use the Zone 2/Zone 3 feature with CDs encoded in DTS.
- Adjust the the second zone and/or third zone volume by using the amplifier in each zone when “Zone2 Volume” or “Zone3 Volume” is set to “Fixed” (page 96).

■ Using the internal amplifiers of this unit

Important safety notice

The speaker terminals of this Receiver should not be connected to a Passive Loudspeaker Selector Box or more than one loudspeaker per channel.

Connection to a Passive Loudspeaker Selector Box or multiple speakers per channel could create an abnormally low impedance load resulting in amplifier damage. See this owner's manual for correct usage.

Compliance with minimum speaker impedance information for all channels must be maintained at all times. This information is found on the back panel of your Receiver.

If you want to use one internal amplifier (SP1 or SP2) of this unit

Connect the Zone 2 or Zone 3 speakers directly to the SP1 or SP2 speaker terminals.

If you want to use two internal amplifiers (SP1 and SP2) of this unit

Connect the Zone 2 and Zone 3 speakers directly to the SP1 and SP2 speaker terminals.

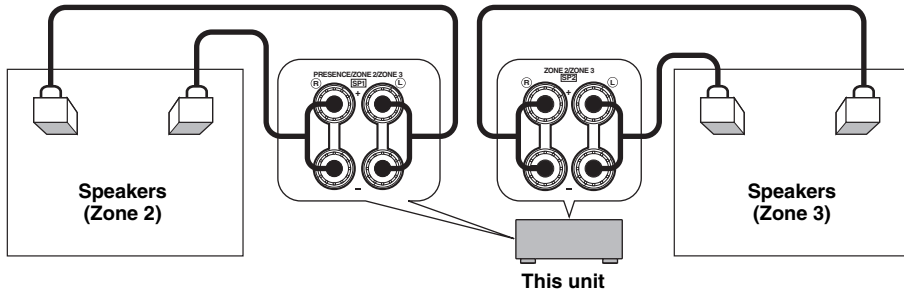

■ Connecting zone video monitors

Connect the video monitor(s) in Zone 2 and/or Zone 3 to the ZONE VIDEO jacks. If you connect the multiple zone video monitors to ZONE VIDEO jacks, the video monitors play back the same source simultaneously.

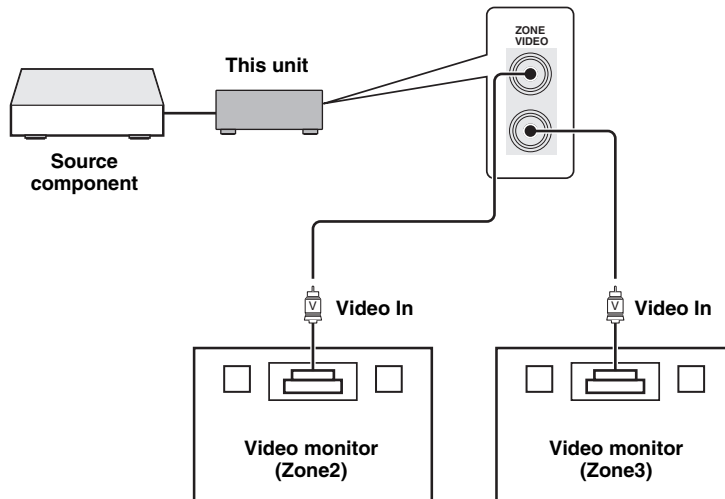

■ Using TRIGGER OUT jacks for Zone 2 and Zone 3

This unit is equipped with two TRIGGER OUT jacks. You can turn on and off the component corresponding to the selection of the input source of the desired zone or turning on and off the desired zone by configuring the “Trigger Output” settings (page 100).

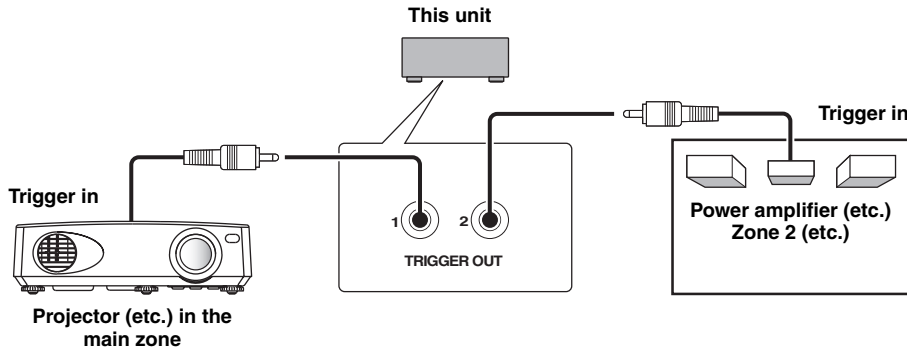

After the connections, turn on this unit and set the speaker terminal assignments with “Zone SP Assign” (page 96).



You must complete this step within 10 seconds while the selected zone flashes in the front panel display. Otherwise, the currently selected zone mode is automatically canceled.

Controlling Zone 2 or Zone 3

You can select the zone you want to control by using the control buttons on the front panel or on the remote control.

■ Basic operation

Front panel operations

- 1 Press **ⓄZONE 2** or **ⓄZONE 3** on the front panel to individually turn on or off Zone 2 or Zone 3.
- 2 Press **ⓄZONE CONTROLS** on the front panel repeatedly to select the zone you want to control.

Each time you press **ⓄZONE CONTROLS**, the front panel display changes as shown below, and the indicator for the currently selected zone flashes for approximately 10 seconds. However, no indicator flashes when the main zone is selected.

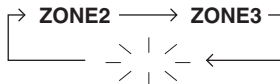

No indicator flashes when the main zone is selected.

ZONE2

Controls the Zone 2 amplifier or tuner functions.

ZONE3

Controls the Zone 3 amplifier or tuner functions.

- 3 Perform the desired operation in the selected zone (page 120).



To turn off the desired zone, press **ⓄZONE 2** or **ⓄZONE 3** again.

Remote control operations

- 1 Press **ⓄZONE** repeatedly to select the zone you want to control. “MAIN”, “ZONE 2”, or “ZONE 3” indicator appears in the display window (④) on the remote control.



- 2 Press **ⓄPOWER** to turn on the selected zone.
- 3 Perform the desired operation in the selected zone (page 120).



To turn off the desired zone, press **ⓄSTANDBY**.

■ Selecting the input source of Zone 2 or Zone 3

Rotate the **ⒸINPUT** selector (or set the operation mode selector to **ⒶAMP** and then press one of the input selector buttons (**Ⓝ**)).

- Select “TUNER” as the input source to use the FM/AM tuning features (page 48) in the selected zone.
- Select “XM” as the input source to use the XM Satellite Radio features (page 53) in the selected zone.
- Select “SIRIUS” as the input source to use the SIRIUS Satellite Radio features (page 58) in the selected zone.
- Select “DOCK” as the input source to use the iPod features (page 66) or Bluetooth features (page 64) in the selected zone.
- Select “USB/NET” as the input source to use the USB features (page 69) or network features (page 69) in the selected zone.

Note

The input sources are shared across all zones.

■ Adjusting the volume level of Zone 2 or Zone 3

Rotate **ⓅVOLUME** (or press **ⓈVOLUME +/-**).



Press **ⓈMUTE** on the remote control to mute the sound output to the selected zone.

Note

When you use the external amplifiers in Zone 2 or Zone 3, **ⓈVOLUME +/-** can be used only when “Zone2 Volume” or “Zone3 Volume” is set to “Variable” (page 96).

■ Adjusting the front speaker balance of Zone 2 or Zone 3

Press **ⓉTONE CONTROL** repeatedly to select “BALANCE” and then rotate the **ⓂPROGRAM** selector for adjustment.

■ Adjusting the tonal quality of Zone 2 or Zone 3

Press **ⓉTONE CONTROL** repeatedly to select the high-frequency response (TREBLE) or the low-frequency response (BASS) and then rotate the **ⓂPROGRAM** selector for adjustment.

Control range: -10.0 dB to +10.0 dB

■ Setting the sleep timer for Zone 2 or Zone 3

Use this feature to turn off the desired zone after a certain amount of time.

Set the operation mode to **ⒶAMP** and then press **ⓇSLEEP** repeatedly to set the amount of time.

The sleep timer setting changes as shown below.

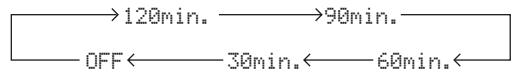

■ Using the zone OSD

You can display the FM/AM radio, XM Satellite Radio (U.S.A. and Canada models only), or HD Radio information (U.S.A. model only) in the video monitor connected to the ZONE VIDEO jacks. You can also browse music contents (such as iPod contents) by using the zone OSD.

- 1 Set the operation mode selector to **ⒶSOURCE** and then press the desired input selector button (**Ⓝ**).
- 2 Press **ⓈDISPLAY** to display the menu screen on the zone OSD.
- 3 Use **ⓉΔ / ▽ / < / >** and **ⓈENTER** to navigate the menu on the zone OSD.

Notes

- The menu displayed in the zone OSD appears in English even if Japanese or Russian is selected.
- There are some characters that cannot be displayed in the front panel display or in the OSD of this unit. Those characters are replaced with underscores “_”.



- You can select the zone(s) of which the operational status is displayed (page 97).
- You can operate the zone OSD in the same way as GUI operations.

Advanced setup

This unit has additional menus that are displayed in the front panel display. The advanced setup menu offers additional operations to adjust and customize the way this unit operates. Change the initial settings (indicated in bold under each parameter) to reflect the needs of your listening environment.

Notes

- Only **A** MASTER ON/OFF, **N** STRAIGHT and the **M** PROGRAM selector are effective while you are using the advanced setup menu.
- All the other operations cannot be made while you are using the advanced setup menu.
- The advanced setup menu is only available in the front panel display.

Using the advanced setup menu

- 1 Press **A** MASTER ON/OFF on the front panel to release it outward to the OFF position to turn off this unit.
- 2 Press and hold **N** STRAIGHT and then press **A** MASTER ON/OFF inward to the ON position to turn on this unit.
This unit turns on, and “ADVANCED SETUP” appears in the front panel display.



- 3 Rotate the **M** PROGRAM selector to select the parameter you want to adjust.
- 4 Press **N** STRAIGHT repeatedly to change the selected parameter setting.
- 5 Press **A** MASTER ON/OFF to release it outward to the OFF position to save the new setting and turn off this unit.



The settings you made are reflected next time you turn on this unit.

■ Speaker impedance **SPEAKER IMP.**

Use this feature to set the speaker impedance of this unit so that it matches that of your speakers.

Choice	Descriptions
8ΩMIN	Select this setting to set the speaker impedance to 8 Ω. The impedance of each speaker must be 8 Ω or higher.
6ΩMIN	Select this setting to set the speaker impedance to 6 Ω. The impedance of each speaker must be 6 Ω or higher (front speakers only: 4 Ω or higher).

■ Remote sensor **REMOTE SENSOR**

Use this feature to activate or deactivate the signal-receiving capability of the remote control sensor on the front panel of this unit.

Choice	Descriptions
ON	Select this setting if you want to activate the signal-receiving capability of the remote control sensor.
OFF	Select this setting if you want to deactivate the signal-receiving capability of the remote control sensor.

Note

We recommend setting the parameter to “ON” in most cases.

■ Wake on RS-232C access

RS232C STANDBY

Use this feature to set this unit to transmit data via the RS-232C interface when this unit is in the standby mode.

Choice	Functions
YES	Select this setting to set this unit to transmit data via the RS-232C interface.
NO	Select this setting to set this unit not to transmit data via the RS-232C interface.

Initial setting:

[U.S.A. and Canada models]: YES

[Other models]: NO

■ Remote control ID setting

REMOTE CON AMP

Use this feature to set the remote control ID of this unit for remote control recognition.

Choice	Descriptions
ID1	Select this setting when the ID of the remote control is set to “ID1”
ID2	Select this setting when the ID of the remote control is set to “ID2”

Setting remote control ID

Use this feature to set the remote control ID. This feature is useful when you control multiple Yamaha AV receiver or amplifier with using the remote control.

Press **ⓇID** repeatedly using a ballpoint pen or similar object on the remote control to select the desired remote control ID.

Each time you press **ⓇID**, the remote control ID indicator changes as shown below.

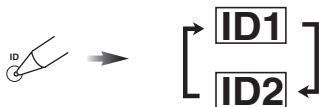

To set the remote control ID of the simplified remote control, see page 116 for details.

■ SIRIUS Satellite Radio Parental Lock code number reset SIRIUS PIN (U.S.A. and Canada models only)

Use this feature to set the code number for the SIRIUS Satellite Radio Parental Lock feature to the initial factory setting.

Choice	Descriptions
RESET	Sets the code number to the initial factory setting.
CANCEL	Cancels the reset of the code number.

■ Tuner frequency step TUNER FRQ STEP (Asia and General models only)

Use this feature to set the tuner frequency step according to the frequency spacing in your area.

Choice	Descriptions
AM10/ FM100	Select this setting for North, Central and South America.
AM9/FM50	Select this setting for all other countries.

■ Bi-amplifier mode BI-AMP

Use this feature to activate or deactivate the bi-amplifier function.

Choice	Descriptions
ON	Select this setting if you want to activate the bi-amplifier function.
OFF	Select this setting if you want to deactivate the bi-amplifier function.

Note

When “BI-AMP” is set to “ON”, the SURROUND BACK terminals cannot be used to connect surround back speakers in that the terminals are already used for the bi-amplifier connection (page 14).

■ Recovery and backup of the system settings RECOV./BACKUP

Use this feature to save and restore the settings of this unit.

Choice	Descriptions
RECOVERY	Restoring the saved setting of this unit.
BACKUP	Saves the current settings of this unit.
CANCEL	Cancels the recovery or backup of the settings of this unit.

Notes

- This unit does not save the FM/AM preset stations, preset USB/network items, and system memory settings.
- If no settings are saved, you cannot select “RECOVERY”.

■ Parameter initialization INITIALIZE

Use this feature to reset the parameters of this unit to the initial factory settings. You can select the category of parameters to be initialized.

Choice	Descriptions
DSP PARAM	Select this setting to initialize all the parameters of the sound field parameters (page 80).
VIDEO	Select this setting to initialize all the parameters in “Video” and “Display Set” (except “Short Message” and “Playback Screen”).
NETWORK	Select this setting to initialize all the parameters in “Network” and MusicCAST information stored in this unit.
ALL	Select this setting to initialize all the parameters of this unit.
CANCEL	Select this setting to cancel the initialization procedure.



To initialize the parameters of each sound field program, use “Initialize” in “Stereo/Surround” (page 84).

■ MAC address filter MAC FILTER

Use this feature to filter the access to this unit via LAN to control this unit by the MAC address of the accessing PC (page 105).

Choice	Descriptions
ON	Only allows to accept the access from the PC whose MAC address is registered to this unit.
OFF	Allows to accept the access from any PC.



You can register the MAC address that is allowed to access when “MAC FILTER” is set to “ON” by using the Web browser (page 105).

■ TV format TV FORMAT

Use this feature to set the color encoding format of your television.

Choices: NTSC, PAL

Initial setting:

[U.S.A., Canada, General and Korea models]: NTSC

[Other models]: PAL



This setting is applied to the video monitor in the main zone, Zone 2 and Zone 3.

■ HDMI monitor check MONITOR CHECK

Use this feature to activate or deactivate the monitor check function of this unit.

Choice	Descriptions
YES	This unit receives the information of the available video signal resolutions from the video monitor connected via HDMI and you can only select the resolutions supported by the video monitor in "Resolution" (page 94).
SKIP	You can select any resolution in "Resolution" (page 94).

■ Language LANGUAGE

Use this feature to select the language of your choice that appears in the GUI (graphical user interface) menu, OSD display in the zone monitor and the messages that appear in the front panel display.

Choices: **ENGLISH** (English), JAPANESE (Japanese), FRENCH (French), GERMAN (German), SPANISH (Spanish), RUSSIAN (Russian)



You can also select the display language with the GUI menu (page 100).

LANGUAGE	GUI menu	Front panel display	Zone OSD
RUSSIAN	<input type="radio"/>	<input type="radio"/>	—
JAPANESE	<input type="radio"/>	—	—
Other languages	<input type="radio"/>	<input type="radio"/>	<input type="radio"/>

- ... The selected language is displayed.
- ... The selected language is not displayed. The menu items and messages are displayed in English.

■ Firmware update FIRM UPDATE

Use this feature to update the firmware of this unit. For details on how to update the firmware, refer to information supplied with updates.

Choice	Descriptions
USB	Updates the firmware of this unit using a USB memory.
NETWORK	Updates the firmware of this unit via network.



To start updating the firmware, rotate the **M**PROGRAM selector to select "USB" or "NETWORK" and then press **M**MENU.

Notes

- Do not use this feature unless you need to update the firmware.
- Be sure to read information supplied with updates before performing firmware updates.

■ Firmware version VERSION

Use this feature to check the version of the firmware currently installed on this unit.

Troubleshooting

Refer to the table below when this unit does not function properly. If the problem you are experiencing is not listed below or if the instruction below does not help, turn off this unit, disconnect the power cable, and contact the nearest authorized Yamaha dealer or service center.

■ General

Problem	Cause	Remedy	See page
This unit fails to turn on or enters the standby mode soon after the power is turned on.	The power cable is not connected or the plug is not completely inserted.	Connect the power cable firmly.	—
	The speaker impedance setting is incorrect.	Set the speaker impedance to match your speakers.	26
	The protection circuitry has been activated.	Make sure that all speaker wire connections on this unit and on all speakers are secure and that the wire for each connection does not touch anything other than its respective connection.	12
	This unit has been exposed to a strong external electric shock (such as lightning or strong static electricity).	Turn off this unit, disconnect the power cable, plug it back in after 30 seconds and then use it normally.	—
No sound.	Incorrect input or output cable connections.	Connect the cables properly. If the problem persists, the cables may be defective.	18-24
	Audio input jack select is set to “HDMI”, “COAX/OPT” or “ANALOG”.	Set the audio input jack select to “AUTO”.	37
	Audio input jack select is set to “ANALOG” while the input source component outputs digital audio signals.	Set the audio input jack select to “AUTO” or “COAX/OPT”.	37
	No appropriate input source has been selected.	Select an appropriate input source with the Ⓒ INPUT selector (or the input selector buttons (Ⓒ)).	36, 37
	Speaker connections are not secure.	Secure the connections.	12
	The volume is turned down or muted.	Turn up the volume.	—
	Signals this unit cannot reproduce are being input from a source component, such as a CD-ROM.	Play a source whose signals can be reproduced by this unit.	—
	The HDMI components connected to this unit do not support the HDCP copy protection standards.	Connect HDMI components that support the HDCP copy protection standards.	16

Problem	Cause	Remedy	See page
No picture.	Your video monitor is connected to one of the analog video output jacks of this unit and the picture is input at different types of video jacks.	Set "Analog ▶ Analog" to "Conversion" or connect your source components in the same way as you connect your video monitor to this unit.	93
	1080p-resolution analog video signals are only output at the COMPONENT VIDEO MONITOR OUT jacks.	Connect your video monitor to the COMPONENT VIDEO MONITOR jacks.	18
	480p-, 576p-, 1080i- and 720p-resolution video signals cannot be output at the S VIDEO and VIDEO MONITOR OUT jacks.	Connect your video monitor to the HDMI OUT or COMPONENT VIDEO MONITOR OUT jacks.	—
	This unit outputs the video signals not supported by the video monitor connected to the HDMI OUT jack.	Select "VIDEO" in "INITIALIZE" to reset the video parameters.	122
		Set "MONITOR CHECK" to "YES".	123
	PURE DIRECT mode is active.	Turn off the PURE DIRECT mode.	47
	Set "Pure Direct" to "Audio + Video".	93	
	Non-standard video signals are input.		
Short message displays do not appear on the video monitor.	"Short Message" is set to "Off".	Set "Short Message" to "On".	98
The sound suddenly goes off.	The protection circuitry has been activated because of a short circuit, etc.	Check that the speaker impedance setting is correct.	26, 121
		Check that the speaker wires are not touching each other and then turn this unit back on.	—
	The sleep timer has turned off this unit.	Turn on this unit, and play the source again.	—
Sound is heard from the speaker on one side only.	Incorrect cable connections.	Connect the cables properly. If the problem persists, the cables may be defective.	12
	The speaker level settings are incorrect.	Adjust "Level" settings.	89
Only the center speaker outputs substantial sound.	When playing a monaural source with a CINEMA DSP program, the source signal is directed to the center channel, and the front and surround speakers output effect sounds.		
No sound is heard from the center speaker.	"Center" in "Configuration" is set to "None".	Set "Center" to "Small" or "Large".	87
No sound is heard from the presence speakers.	This unit is in the "STRAIGHT" mode.	Press ⓃSTRAIGHT to turn off the "STRAIGHT" mode.	46
	You are using a source or program combination that does not output sound from all channels.	Try another sound field program.	36
No sound is heard from the surround speakers.	"Surround" in "Configuration" is set to "None".	Set "Surround" to "Small" or "Large".	87
	This unit is in the "STRAIGHT" mode and a monaural source is being played back.	Press ⓃSTRAIGHT to turn off the "STRAIGHT" mode.	46
	The surround speakers are connected to the SURROUND BACK speaker terminals.	Connect the surround speakers to the SURROUND speaker terminals.	46

Problem	Cause	Remedy	See page
No sound is heard from the subwoofer.	“Bass Out” in “Configuration” is set to “Front” when a Dolby Digital or DTS signal is being played.	Set “Bass Out” to “SWFR” or “Front + SWFR”.	88
	“Bass Out” in “Configuration” is set to “SWFR” or “Front” when a 2-channel source is being played.	Set “Bass Out” to “Front + SWFR”.	88
	The source does not contain low-frequency signals.		
No sound is heard from the surround back speakers.	“Surround Back” in “Configuration” is set to “None”.	Check whether “Surround” is set to “Small” or “Large” and configure “Surround Back” properly.	87, 88
	While this unit is in the CINEMA DSP 3D mode, no sound is output at the surround back speakers.		
The audio input sources cannot be played in the desired digital audio signal format (Desired input source indicator or decoder indicator in the front panel display does not light up).	The connected component is not set to output the desired digital audio signals.	Make an appropriate setting following the operating instructions for your component.	—
	Audio input jack select is set to “ANALOG”.	Set the audio input jack select to “AUTO”.	37
A humming sound is heard.	Incorrect cable connections.	Connect the audio cables firmly. If the problem persists, the cables may be defective.	—
	No connection from the turntable to the GND terminal.	Connect the grounding cable of the turntable to the GND terminal of this unit.	21
The volume level is low while a record is being played.	The record is being played on a turntable with an MC cartridge.	Connect your turntable to this unit through an MC-head amplifier.	21
The volume level cannot be increased, or the sound is distorted.	The component connected to the AUDIO OUT (REC) jacks of this unit is turned off.	Turn on the power of the component.	—
A source cannot be recorded by the recording component.	The audio source connected to the MULTI CH INPUT jacks of this unit cannot be recorded.		
	A given input source is not output at the same output channel (e.g. DVR IN to DVR OUT).	Connect the recording component to another channel that is not being used for connecting the source component.	20
	You are trying to record a DTS source. (DTS signal is a digital bitstream. Attempting to record the DTS bitstream digitally will result in noise being recorded.)	Make a setting so that the analog signal will be output from your DTS-compatible player and then connect the DTS-compatible player to the AUDIO IN jacks while the recording component is connected to the analog AUDIO OUT (DVR, VCR or MD/CD-R) jacks.	20

Problem	Cause	Remedy	See page
An audio source cannot be recorded by the digital recording component connected to the DIGITAL OUTPUT jacks.	The audio source component is not connected to the DIGITAL INPUT jacks.	Connect the audio source component to the DIGITAL INPUT jacks.	20
	Some components cannot records Dolby Digital or DTS sources.		
	You are trying to record an audio source input at the DOCK terminal by the digital recording component connected to the DIGITAL OUTPUT jacks.	Connect the recording component to the analog AUDIO OUT (DVR, VCR or MD/CD-R) jacks.	20
	(U.S.A. model only) HD Radio signals are not output at the DIGITAL OUTPUT jacks	Connect the recording component to the analog AUDIO OUT (DVR, VCR or MD/CD-R) jacks.	20
An audio source cannot be recorded by the analog recording component connected to the analog AUDIO OUT (DVR, VCR or MD/CD-R) jacks.	The audio source component is not connected to the analog AUDIO IN jacks.	Connect the audio source component to the AUDIO IN jacks.	20
	XM Satellite Radio and SIRIUS Satellite Radio signals are not output at the analog AUDIO OUT (DVR, VCR or MD/CD-R) jacks.		
Recorded materials sound differently.	The settings made on this unit (such as tonal quality, volume level and sound field programs) do not affect recorded material.		
The sound field parameters and some other settings of this unit cannot be changed.	“Memory Guard” is set to “On”.	Set “Memory Guard” to “Off”.	97
This unit does not operate properly.	The internal microcomputer has been frozen by an external electric shock (such as lightning or excessive static electricity) or by a power supply with low voltage.	Disconnect the power cable from the AC wall outlet and then plug it in again after about 30 seconds.	—
“CHECK SP WIRES” appears in the front panel display.	Speaker cables are short-circuited.	Make sure all speaker cables are connected correctly.	12
There is noise interference from digital or radio frequency equipment.	This unit is too close to the digital or high-frequency equipment.	Move this unit further away from such equipment.	—
The picture is disturbed.	The video source uses scrambled or encoded signals to prevent dubbing.		
This unit suddenly enters the standby mode.	The internal temperature becomes too high and the overheat protection circuitry has been activated.	Wait about 1 hour for this unit to cool down and then turn it back on.	—

■ HDMI

Problem	Cause	Remedy	See page
No picture or sound.	The number of the connected HDMI components is over the limit.	Reduce the number of the connected HDMI components.	—
	HDCP authentication failed.	Check that the connected HDMI components support the HDCP copy protection standards.	—

■ Tuner (FM/AM)

Problem	Cause	Remedy	See page	
FM	FM stereo reception is noisy.	The characteristics of FM stereo broadcasts may cause this problem when the transmitter is too far away or the antenna input is poor.	Check the antenna connections.	24
			Try using a high-quality directional FM antenna.	—
			Use the manual tuning method.	48
	There is distortion, and clear reception cannot be obtained even with a good FM antenna.	There is multi-path interference.	Adjust the antenna position to eliminate multi-path interference.	—
	The desired station cannot be tuned into with the automatic tuning method.	The signal is too weak.	Use a high-quality directional FM antenna.	—
Use the manual tuning method.			48	
Previously preset stations can no longer be tuned into.	This unit has been disconnected for a long period.	Preset the stations again.	49	
AM	The desired station cannot be tuned into with the automatic tuning method.	The signal is weak or the antenna connections are loose.	Tighten the AM loop antenna connections and orient it for the best reception.	24
			Use the manual tuning method.	48
	There are continuous crackling and hissing noises.	Supplied AM loop antenna is not connected.	Connect the AM loop antenna correctly even if you use an outdoor antenna.	24
		Noises can result from lightning, fluorescent lamps, motors, thermostats and other electrical equipment.	Use an outdoor antenna and a ground wire. This will help somewhat, but it is difficult to eliminate all noise.	24
	There are buzzing and whining noises.	A TV set is being used nearby.	Move this unit away from the TV set.	—

■ HD Radio (U.S.A. model only)

Problem	Cause	Remedy	See page
This unit cannot receive the HD Radio signals of the selected radio station.	The radio station provides analog FM/AM radio service only.	Select other radio stations that provides the HD Radio service.	48
	The signal is too weak.	Adjust the antenna position.	—
		Use a high-quality FM/AM antenna.	—
This unit cannot select other audio programs than the main program.	The radio station provides an audio program only.		
HD Radio information does not appear.	The radio station does not provide the information.		

■ iTunes Tagging (U.S.A. model only)

Status message	Cause	Remedy	See page
Insufficient Data	Tag data is not saved because of invalid data.	The HD Radio station currently selected does not support the iTunes Tagging feature.	—
Tag already saved	Tag data for the same content has been already saved.		
Tag storage full Connect iPod	Tag data cannot be stored because the internal memory of this unit is full.	Station your iPod in a Yamaha iPod universal dock connected to the DOCK terminal of this unit.	22
iPod full Tags cannot be stored	Tag data cannot be stored on your iPod because the HDD space of your iPod is full.	Delete unnecessary data from your iPod to make room and try again.	—
Transferring Failed	Tag data cannot be transferred to your iPod.	Check if the Yamaha iPod universal dock is connected to the DOCK terminal properly. Re-station your iPod and try again.	22

■ XM Satellite Radio

If an operation takes longer than usual or an error occurs, one of the following messages may appear in the front panel display. In this case, read the cause and follow the corresponding remedies.

Status message	Cause	Remedy	See page
CHECK XM TUNER	The XM Mini-Tuner is not installed in the XM Mini-Tuner Home Dock or the XM Mini-Tuner Home Dock is not connected to this unit.	Confirm the XM Mini-Tuner is fully seated in the dock and check the XM Mini-Tuner Home Dock cable is connected to this unit.	53
CHECK ANTENNA	The XM antenna is not connected to the XM Mini-Tuner Home Dock or the XM antenna cable has become damaged.	Check that the XM antenna is securely connected to the XM Mini-Tuner Home Dock and check the antenna cable for damage. Replace the XM antenna if the cable is damaged.	53
LOADING	The XM Mini-Tuner is acquiring audio or program information from the XM satellite signal. This message can also occur in weak XM signal conditions. Note that this unit may not respond to some operations while this message is displayed.	This message should disappear in a few seconds in good signal conditions. If you see this message often, reposition the XM antenna to get better signal reception. Use the "ANTENNA INFO" information in the front panel display or "XM Information" screen in the video monitor to check the antenna reception level.	56
NO SIGNAL	The XM Mini-Tuner is not receiving the XM satellite signal. Something may be blocking the XM antenna's view of the satellites or the antenna is not properly aimed.	Check for antenna obstructions and reposition the XM antenna to get better signal reception. Use the "ANTENNA INFO" information in the front panel display or "XM Information" screen in the video monitor to check the antenna reception level. See instructions supplied with the XM Mini-Tuner and Dock for antenna installation information.	56
CH OFF AIR	The XM channel you selected is not currently broadcasting.	Check back at a later time; in the meantime, select another channel.	—
CH UNAUTH	You may be attempting to tune to an XM channel that is blocked or that you cannot receive with your XM subscription package.	Consult the latest channel guide at http://www.xmradio.com/ (US residents) and http://www.xmradio.ca/ (Canadian residents) for the current list of channels. For information on receiving this channel, visit http://www.xmradio.com/ (US residents) and http://www.xmradio.ca/ (Canadian residents) or contact XM Satellite Radio at 1-800-967-2346 (US residents) and 1-877-438-9677 (Canadian residents).	53
CH UNAVAIL	The selected channel is not available. The channel may have been reassigned to a different channel number. This message may occur initially with a new XM Mini-Tuner or an XM Mini-Tuner that has not received XM's signal for an extended period.	Consult the latest channel guide at http://www.xmradio.com/ (US residents) and http://www.xmradio.ca/ (Canadian residents) for the current list of channels. For cases of a new XM Mini-Tuner or an XM Mini-Tuner that has not received XM's signal for an extended period, allow the XM Mini-Tuner to receive the XM satellite signal for at least 5 minutes and then try to select the channel again.	—
UPGRADE XM TUNER	The connected XM Mini-Tuner is incompatible with this unit.	Use the XM Mini-Tuner compatible with the XM Rev 4x.	—
----	No artist name or song title is available for this selection.	No action required.	—

■ SIRIUS Satellite Radio

If an operation takes longer than usual or an error occurs, one of the following messages may appear in the front panel display. In this case, read the cause and follow the corresponding remedies.

Status message	Cause	Remedy	See page
ANTENNA ERROR	The antenna is not connected to the SiriusConnect tuner properly.	Check the connection of the antenna and SiriusConnect tuner.	58
CHECK SR TUNER	The SiriusConnect tuner is not connected to the SIRIUS jack of this unit correctly.	Check the connection of the SiriusConnect tuner and this unit.	58
	The SiriusConnect tuner is not connected to the AC wall outlet.	Connect the power cable of the SiriusConnect tuner to the AC wall outlet.	58
NOT SUPPORTED	This unit does not support the connected SIRIUS Satellite Radio tuner.	Connect the SiriusConnect tuner that this unit supports.	58
ACQUIRING	The signal is too weak.	Adjust the orientation of the antenna of the SiriusConnect tuner. Use the “ANTENNA INFO” information in the front panel display or “SIRIUS Information” screen in the video monitor to check the antenna reception level.	63
UPDATING	The SiriusConnect tuner is updating the channel list.	Wait until the updating is complete.	—
	The period of the subscription is end.	Contact SIRIUS Satellite Radio to renew the subscription.	59
F/W UPDATING	The SiriusConnect tuner is updating the firmware.	Wait until the updating is complete.	—
CALL SIRIUS (CALL 888-539-SIRIUS TO SUBSCRIBE)	The selected channel is not subscribed.	Contact SIRIUS Satellite Radio to subscribe the selected channel. URL: https://activate.siriusradio.com/ Phone: 1-888-539-SIRIUS (1-888-539-7474)	59
		Select another channel.	59
SUB UPDATED	The subscription information is updated.		
INVALID	The selected channel is currently out of service.	Select another channel.	59
Not Available	The operation you made is not available.		

■ Remote control

Problem	Cause	Remedy	See page
The remote control does not work or function properly.	Wrong distance or angle.	The remote control will function within a maximum range of 6 m (20 ft) and no more than 30 degrees off-axis from the front panel.	28
	Direct sunlight or lighting (from an inverter type of fluorescent lamp, etc.) is striking the remote control sensor of this unit.	Reposition this unit.	—
	The batteries are weak.	Replace all batteries.	4
	The batteries do not last long and get quickly exhausted.	Using alkaline batteries is strongly recommended.	—
		Set the backlight mode to “OFF”.	109
	The operation mode selector is set incorrectly.	Set the operation mode selector correctly. When operating this unit, set it to the ⓂAMP position. When operating the component selected by the input selector button, set it to the ⓂSOURCE position. When operating the TV set in the ⓂTV area, set it to the ⓂTV position.	—
	The control zone setting is incorrect.	Select the zone you want to control.	119
	The remote control code is not correctly set.	Set the remote control code correctly using “List of remote control codes” at the end of this manual.	109
		Try setting another code of the same manufacturer using “List of remote control codes” at the end of this manual.	109
	The remote control ID of the remote control and this unit do not match.	Match the remote control ID of this unit and the remote control.	116, 121
Even if the remote control code is correctly set, there are some models that do not respond to the remote control.	Program the necessary functions independently into the programmable buttons using the Learn feature.	111	
The remote control does not learn new functions.	The batteries of this remote control and/or the other remote control are too weak.	Replace the batteries.	4
	The distance between the two remote controls is too much or too little.	Place the remote controls at the proper distance.	111
	The signal coding or modulation of the other remote control is not compatible with this remote control.	Learning is not possible.	—
	Memory capacity is full.	Delete other unnecessary functions to make room for the new functions.	115

■ USB and Network

Problem	Cause	Remedy	See page
“No Device” is displayed even when a USB device is present.	This unit recognized the USB storage device as an illegal device.	Turn this unit off then on again.	26
The music files and directories in the USB device cannot be viewed.	The music files and directories are placed in locations other than the FAT area.	Place music files and directories in the FAT area.	—
	You are attempting to browse directory hierarchies of over 8 levels or a directory with more than 500 files.	Modify the data structure on your USB device.	—
The PC server/MCX-2000/Internet Radio does not function properly.	The IP address is not set properly.	Set the DHCP server function of the router to ON. Alternately, perform manual configuration according to the current operating environment.	95
	The network cable is not connected.	Connect it properly.	23
The music in the PC server cannot be played back.	The PC does not have Windows Media Player 11 or Windows Media Connect 2.0 installed in it.	Install Windows Media Player 11 or Windows Media Connect 2.0 in the PC.	—
	The music is recorded in a format that cannot be played on this unit. This unit cannot play music formats other than WMA, MP3, MPEG-4 AAC, and WAV (PCM format). Also note that it cannot play certain music files even if these are recorded in the WMA, MP3, MPEG-4 AAC, or WAV format.	Play music recorded in a format that this unit is compatible with.	—
The MusicCAST server cannot be connected.	You are attempting to connect to MCX-1000. The MusicCAST server that can be connected by this unit is MCX-2000.	Use MCX-2000 or the PC server.	—
	Auto Configuration is not executed.	Set your Yamaha MCX-2000 to the “Auto Config” mode.	70
The Internet Radio cannot be played.	The firewall of the network device is activated. The Internet Radio can be played only when it passes through the port designated by each radio station. The port number is variable depending on radio station.	Check the firewall setting of the network device.	—
	Connection to the Internet is disconnected.	Check the configuration of the network device, and then contact the network connection provider.	—
This unit does not recall the correct item by using numeric buttons (1-8).	The connected USB device is incorrect.	Connect the USB device that stores the preset item.	23
	The directory that stores the selected item is changed.	Preset the desired item to the numeric button (1-8) again.	72
This unit does not recall the selected item by using numeric buttons (1-8).	The USB device is not connected correctly.	Connect the USB device properly.	23
	The PC or MCX-2000 that stores the selected item is turned off.	Turn on the PC or MCX-2000.	—
	The selected Internet Radio station is temporarily unavailable or out of service.	Try again when the selected Internet Radio is providing the service. Preset other Internet Radio stations.	73 72

Status message	Cause	Remedy	See page
Please wait (Starting Server)	This unit is in the middle of waking up MCX-2000 that has been set to the standby mode.	Wait for approximately 20 seconds.	—
Connect error	There is a problem with the signal path from your network to this unit.	Check the connection between this unit and the LAN port on your router or hub.	23
		Make sure your router is properly connected and turned on. Also, make sure your modem is properly connected and turned on when you are attempting to listen to Internet Radio.	23
Disconnected	Your USB storage device or USB portable audio player has been disconnected from the USB port of this unit.	Check the connection between this unit and your USB storage device or USB portable audio player.	—
	The PC server or MCX-2000 previously connected to this unit no longer exists.	Connect this unit to the available PC server or MCX-2000.	23
No Device	There is a problem with the signal path from your USB storage device or USB portable audio player to this unit.	Turn off this unit and reconnect your USB storage device or USB portable audio player to the USB port of this unit.	23
		Try resetting your USB storage device or USB portable audio player.	—
Access error	This unit cannot access your USB storage device or USB portable audio player.	Try another USB storage device or USB portable audio player.	—
	There is a problem with the signal path from your USB storage device or USB portable audio player to this unit.	Turn off this unit and reconnect your USB storage device or USB portable audio player to the USB port of this unit.	23
		Try resetting your USB storage device or USB portable audio player.	—
Unable to play	This unit cannot play back the songs currently stored on your PC.	Make sure Windows Media Player 11 or Windows Media Connect 2.0 is installed on your PC.	—
		Check that the songs currently stored on your PC are playable (MP3, WMA, MPEG-4 AAC, and WAV).	—
		Store some other playable music files (MP3, WMA, MPEG-4 AAC, and WAV) on your PC.	—
	The network may be overloaded with heavy traffic, and playback is interrupted.	Try preparing a network exclusively for use with this unit to separate it from general network traffic.	—
List updated	The list of the contents stored on your PC server or MCX-2000 has been updated.		
Bookmark ON	The desired Internet Radio station has been added to the “Bookmarks” list.		
Bookmark OFF	The stored Internet Radio station has been removed from the “Bookmarks” list.		
Empty Memory!	No items are assigned to the selected numeric button.	Assign the desired item to the numeric button.	72
Not found!	This unit cannot find the assigned item for the selected numeric button.	Connect the USB device that stores the preset item.	—
		Turn on the PC or MCX-2000.	—
		Try again when the selected Internet Radio is providing the service.	73
		Preset the desired item to the numeric button (1-8) again.	72
USB Overloaded	Over current passes through the connected USB device.	Turn off this unit and then disconnect the USB device. If the message appears when you connect the USB device again, this unit may not compatible with the USB device.	—

■ iPod

Note

In case of a transmission error without a status message appearing in the panel display or in the GUI screen, check the connection of your iPod (page 22).

Status message	Cause	Remedy	See page
Loading...	This unit is in the middle of recognizing the connection with your iPod.		
	This unit is in the middle of acquiring song lists from your iPod.		
Connect error	There is a problem with the signal path from your iPod to this unit.	Turn off this unit and reconnect the Yamaha iPod universal dock to the DOCK terminal of this unit.	22
		Try resetting your iPod.	—
Unknown iPod	The iPod being used is not supported by this unit.	This unit supports iPod touch, iPod (Click Wheel, including iPod classic), iPod nano and iPod mini.	—
iPod Connected	Your iPod is properly stationed in a Yamaha iPod universal dock (such as YDS-11, sold separately) connected to the DOCK terminal of this unit, and the connection between your iPod and this unit is complete.		
iPod Disconnected	Your iPod was removed from a Yamaha iPod universal dock (such as YDS-11, sold separately) connected to the DOCK terminal of this unit.	Station your iPod back in a Yamaha iPod universal dock (such as YDS-11, sold separately) connected to the DOCK terminal of this unit.	22
Unable to play	This unit cannot play back the songs currently stored on your iPod.	Check that the songs currently stored on your iPod are playable.	—
		Store some other playable music files on your iPod.	—

■ Bluetooth

Status message	Cause	Remedy	See page
Searching...	The Bluetooth wireless audio receiver and the Bluetooth component is in the middle of the pairing.		
	The Bluetooth wireless audio receiver and the Bluetooth component is in the middle of establishing the connection.		
Completed	The pairing is completed.		
Canceled	The pairing is canceled.		
BT Connected	The connection between the Yamaha Bluetooth wireless audio receiver (such as YBA-10, sold separately) and the Bluetooth component is established.		
BT Disconnected	The Bluetooth component is disconnected from the Yamaha Bluetooth wireless audio receiver (such as YBA-10, sold separately).		

■ Automatic setup

Before automatic setup

Error message	Cause	Remedy	See page
Connect MIC!	Optimizer microphone is not connected.	Connect the supplied optimizer microphone to the OPTIMIZER MIC jack on the front panel.	30
Unplug Phones!	Headphones are connected.	Unplug the headphones.	—
Select Setup Item!	No check items are selected as the measurement items.	Select the desired check items.	31
Memory Guard!	The parameters of this unit are protected.	Set "Memory Guard" to "Off".	97

During automatic setup

Error message	Cause	Remedy	See page
E01:No Front SP	Front L/R channel signals are not detected.	Check the front L/R speaker connections.	12
E02:No Sur. SP	A surround channel signal is not detected.	Check the surround speaker connections.	12
E03:No PRNS SP	A presence channel signal is not detected.	Check the presence speaker connections.	12
E04:SBR→SBL	Only right surround back channel signal is detected.	Connect the surround back speaker to the SURROUND BACK (SINGLE) speaker terminal if you only have one surround back speaker.	12
E05:Noisy	Background noise is too loud.	Perform the automatic setup in a quiet environment.	—
		Turn off noisy electric equipment like air conditioners or move them away from the optimizer microphone.	—
E06:Check Sur.	Surround back speakers are connected, though surround L/R speakers are not.	Connect surround speakers when you use surround back speakers.	13
E07:No MIC	The optimizer microphone was unplugged during the "automatic setup" procedure.	Connect the supplied optimizer microphone to the OPTIMIZER MIC jack on the front panel.	30
E08:No Signal	The optimizer microphone does not detect test tones.	Check the microphone setting.	30
		Check the speaker connections and placement.	12
		The optimizer microphone or OPTIMIZER MIC jack may be defective. Contact the nearest Yamaha dealer or service center.	—
E09:User Cancel	The "automatic setup" procedure was cancelled due to user activity.	Perform the automatic setup again.	30
E10:Internal Err.	An internal error occurred.	Perform the automatic setup again.	30

After automatic setup

Warning message	Cause	Remedy	See page
W1:Out of Phase	Speaker polarity is not correct. This message may appear depending on the speakers even when the speakers are connected correctly.	Check the speaker connections for proper polarity (+ or -).	12
W2:Over Distance	The distance between the speaker and the listening position is over 24 m (80 ft).	Bring the speaker closer to the listening position.	—
W3:Level Error	The difference of volume level among speakers is excessive.	Readjust the speaker installation so that all speakers are set in locations with similar conditions.	—
		Check the speaker connections.	12
		Use speakers of similar quality.	—
		Adjust the output volume of the subwoofer.	30
W4:SP Mismatch	The result of “Wiring” checked by the automatic setup is different from the settings manually configured in “Configuration”.	Manually configure the speaker settings in “Configuration”.	87
	“Wiring” has not been checked.	Manually configure the speaker settings in “Configuration”.	87

Notes

- If the “ERROR” or “WARNING” screens appears, check the cause of the problem, then run perform the automatic setup again.
- If warning message “W2” or “W3” appears, the adjustments are made, however the adjustment may not be optimal.
- Depending on the speakers, warning message “W1” may appears even if the speaker connections are correct.
- If error message “E10” occurs repeatedly, contact a qualified Yamaha service center.

Resetting the system

Use this feature to reset all the parameters of this unit to the initial factory settings.

Notes

- This procedure completely resets all the parameters of this unit including the “GUI menu” parameters.
- The initial factory settings are activated next time you turn on this unit.



To cancel the initialization procedure at any time without making any changes, press **Ⓐ MASTER ON/OFF** on the front panel to release it outward to the OFF position.

1 Press **Ⓐ MASTER ON/OFF** on the front panel to release it outward to the OFF position to turn off this unit.

2 Press and hold **Ⓝ STRAIGHT** and then press **Ⓐ MASTER ON/OFF** inward to the ON position to turn on this unit.

This unit turns on, and “ADVANCED SETUP” appears in the front panel display.



3 Rotate the **Ⓜ PROGRAM** selector to select “INITIALIZE”.



4 Press **Ⓝ STRAIGHT** repeatedly to select “ALL”.



Select “CANCEL” to cancel the initialization procedure without making any changes.

5 Press **Ⓐ MASTER ON/OFF** to release it outward to the OFF position to confirm your selection and turn off this unit.

Operation modes of front panel controls

If you perform a mode trigger operation using the front panel controls, this unit enters the following mode. In each mode, you can use the front panel controls as shown below. If no operation is performed for five seconds in each mode, this unit automatically returns to the default mode.

Mode trigger button	Mode to enter
—	Default mode
Press Ⓜ AUDIO SELECT/REC OUT	Audio select mode
Press and hold Ⓜ AUDIO SELECT/REC OUT	Rec out mode
Press Ⓜ MENU	GUI menu mode
Press Ⓜ TONE CONTROL	Sound adjust mode
Press and hold Ⓜ ENTER	BT pairing mode

Available operations in each mode

Mode	Ⓜ AUDIO SELECT/REC OUT	Ⓜ MENU	Ⓜ TONE CONTROL	Ⓜ ENTER	Ⓜ PROGRAM selector
Default	to Audio select mode	to GUI menu mode	to Sound adjust mode	—	Select a sound field programs (page 40)
Audio select	to default mode	to GUI menu mode	to Sound adjust mode	—	Select an audio input jack (page 37)
Rec out	to Audio select mode	to GUI menu mode	to Sound adjust mode	—	Select a recording source (page 47)
GUI menu	to Audio select mode	to default mode	—	Confirm the selection in the GUI menu (page 79)	Menu up/down
Sound adjust	to Audio select mode	to GUI menu mode	Select a parameter for adjustment (page 47)	—	Adjust parameters (page 47)
BT pairing*	to Audio select mode (the pairing process continues)	to GUI menu mode (the pairing process continues)	—	to default mode (the pairing process continues)	Select a sound field program

Note

* In the BT pairing mode, this unit searches for Bluetooth components to be paired. This mode is available only when “DOCK” is selected as an input source and a Yamaha Bluetooth wireless audio receiver (such as YBA-10, sold separately) is connected to the DOCK terminal of this unit.

Glossary

■ Audio and video synchronization (lip sync)

Lip sync, an abbreviation for lip synchronization, is a technical term that involves both a problem and a capability of maintaining audio and video signals synchronized during post-production and transmission. Whereas the audio and video latency requires complex end-user adjustments, HDMI version 1.3 incorporates an automatic audio and video syncing capability that allows devices to perform this synchronization automatically and accurately without user interaction.

■ Bi-amplification connection

A bi-amplification connection uses two amplifiers for a speaker. One amplifier is connected to the woofer section of a loudspeaker while the other is connected to the combined mid and tweeter section. With this arrangement each amplifier operates over a restricted frequency range. This restricted range presents each amplifier with a much simpler job and each amplifier is less likely to influence the sound in some way. The internal crossover of the speaker consists of a LPF (low pass filter) and a HPF (high pass filter). As its name implies, the LPF passes frequencies below a cutoff and rejects frequencies above the cutoff frequency. Likewise, the HPF passes frequencies above its cutoff.

■ Component video signal

With the component video signal system, the video signal is separated into the Y signal for the luminance and the Pb and Pr signals for the chrominance. Color can be reproduced more faithfully with this system because each of these signals is independent. The component signal is also called the “color difference signal” because the luminance signal is subtracted from the color signal. A monitor with component input jacks is required in order to output component signals.

■ Composite video signal

With the composite video signal system, the video signal is composed of three basic elements of a video picture: color, brightness and synchronization data. A composite video jack on a video component transmits these three elements combined.

■ Deep Color

Deep Color refers to the use of various color depths in displays, up from the 24-bit depths in previous versions of the HDMI specification. This extra bit depth allows HDTVs and other displays go from millions of colors to billions of colors and eliminate on-screen color banding for smooth tonal transitions and subtle gradations between colors. The increased contrast ratio can represent many times more shades of gray between black and white. Also Deep Color increases the number of available colors within the boundaries defined by the RGB or YCbCr color space.

■ Dolby Digital

Dolby Digital is a digital surround sound system that gives you completely independent multi-channel audio. With 3 front channels (front L/R and center), and 2 surround stereo channels, Dolby Digital provides 5 full-range audio channels. With an additional channel especially for bass effects, called LFE (Low Frequency Effect), the system has a total of 5.1-channels (LFE is counted as 0.1 channel). By using 2-channel stereo for the surround speakers, more accurate moving sound effects and surround sound environment are possible than with Dolby Surround. The wide dynamic range from maximum to minimum volume reproduced by the 5 full-range channels and the precise sound orientation generated using digital sound processing provide listeners with unprecedented excitement and realism. With this unit, any sound environment from monaural up to a 5.1-channel configuration can be freely selected for your enjoyment.

■ Dolby Digital EX

Dolby Digital EX creates 6 full-bandwidth output channels from 5.1-channel sources. This is done using a matrix decoder that derives 3 surround channels from the 2 in the original recording. For the best results, Dolby Digital EX should be used with movie sound tracks recorded with Dolby Digital Surround EX. With this additional channel, you can experience more dynamic and realistic moving sound especially with scenes with “fly-over” and “fly-around” effects.

■ Dolby Digital Plus

Dolby Digital Plus is an advanced audio technology developed for high-definition programming and media including HD broadcasts, HD DVD, and Blu-ray Disc. Selected as a mandatory audio standard for HD DVD and as an optional audio standard for Blu-ray Disc, this technology delivers multichannel sound with discrete channel output. Supporting bitrates up to 6.0 Mbps, Dolby Digital Plus can carry up to 7.1 discrete audio channels simultaneously. Supported by HDMI version 1.3 and designed for the optical disc players and AV receivers/amplifiers of the future, Dolby Digital Plus also remains fully compatible with the existing multichannel audio systems that incorporate Dolby Digital.

■ Dolby Pro Logic II

Dolby Pro Logic II is an improved technique used to decode vast numbers of existing Dolby Surround sources. This new technology enables a discrete 5-channel playback with 2 front left and right channels, 1 center channel, and 2 surround left and right channels instead of only 1 surround channel for conventional Pro Logic technology. There are three modes available: “Music mode” for music sources, “Movie mode” for movie sources and “Game mode” for game sources.

■ Dolby Pro Logic IIx

Dolby Pro Logic IIx is a new technology enabling discrete multi-channel playback from 2-channel or multi-channel sources. There are three modes available: “Music mode” for music sources, “Movie mode” for movie sources (for 2-channel sources only) and “Game mode” for game sources.

■ Dolby Surround

Dolby Surround uses a 4-channel analog recording system to reproduce realistic and dynamic sound effects: 2 front left and right channels (stereo), a center channel for dialog (monaural), and a surround channel for special sound effects (monaural). The surround channel reproduces sound within a narrow frequency range. Dolby Surround is widely used with nearly all video tapes and laser discs, and in many TV and cable broadcasts as well. The Dolby Pro Logic decoder built into this unit employs a digital signal processing system that automatically stabilizes the volume on each channel to enhance moving sound effects and directionality.

■ Dolby TrueHD

Dolby TrueHD is an advanced lossless audio technology developed for high-definition disc-based media including HD DVD and Blu-ray Disc. Selected as a mandatory audio standard for HD DVD and as an optional audio standard for Blu-ray Disc, this technology delivers sound that is bit-for-bit identical to the studio master, offering a high-definition home theater experience. Supporting bitrates up to 18.0 Mbps, Dolby TrueHD can carry up to 8 discrete channels of 24-bit/96 kHz audio simultaneously. Supported by HDMI version 1.3 and designed for the optical disc players and AV receivers/amplifiers of the future, Dolby TrueHD also remains fully compatible with the existing multichannel audio systems and retains the metadata capability of Dolby Digital, allowing dialog normalization and dynamic range control.

■ DSD

Direct Stream Digital (DSD) technology stores audio signals on digital storage media, such as Super Audio CDs. Using DSD, signals are stored as single bit values at a high-frequency sampling rate of 2.8224 MHz, while noise shaping and oversampling are used to reduce distortion, a common occurrence with very high quantization of audio signals. Due to the high sampling rate, better audio quality can be achieved than that offered by the PCM format used for normal audio CDs.

■ DTS 96/24

DTS 96/24 offers an unprecedented level of audio quality for multi-channel sound on DVD video, and is fully backward-compatible with all DTS decoders. “96” refers to a 96 kHz sampling rate compared to the typical 48 kHz sampling rate. “24” refers to 24-bit word length.

DTS 96/24 offers sound quality transparent to the original 96/24 master, and 96/24 5.1-channel sound with full-quality full-motion video for music programs and motion picture soundtracks on DVD video.

■ DTS Digital Surround

DTS digital surround was developed to replace the analog soundtracks of movies with a 6.1-channel digital sound track, and is now rapidly gaining popularity in movie theaters around the world. DTS, Inc. has developed a home theater system so that you can enjoy the depth of sound and natural spatial representation of DTS digital surround in your home. This system produces practically distortion-free 6-channel sound (technically, front left and right, center, surround left and right, and LFE 0.1 (subwoofer) channels for a total of 5.1 channels). This unit incorporates a DTS-ES decoder that enables 6.1-channel reproduction by adding the surround back channel to the existing 5.1-channel format.

■ DTS Express

DTS Express is an advanced audio technology for the optional feature on Blu-ray Disc or HD DVD, which offers high-quality, low bit rate audio optimized for network streaming, and Internet applications. DTS Express is used for the Secondary Audio feature of Blu-ray Disc or the Sub Audio feature of HD DVD. These features deliver audio commentaries (for example, the additional commentaries made by the director of a film) on demand by the users via the Internet, etc. DTS Express signals are mixed down with the main audio stream on the player component, and the component sends the mixed audio stream to the AV receivers/amplifiers via digital coaxial, digital optical, or analog connections.

■ DTS-HD High Resolution Audio

DTS-HD High Resolution Audio is an high resolution audio technology developed for high-definition disc-based media including HD DVD and Blu-ray Disc. Selected as an optional audio standard for both HD DVD and Blu-ray Disc, this technology delivers sound that is virtually indistinguishable from the original, offering a high-definition home theater experience. Supporting bitrates up to 3.0 Mbps for HD DVD and 6.0 Mbps for Blu-ray Disc, DTS-HD High Resolution Audio can carry up to 7.1 discrete channels of 24-bit/96 kHz audio simultaneously. Supported by HDMI version 1.3 and designed for the optical disc players and AV receivers/amplifiers of the future, DTS-HD High Resolution Audio also remains fully compatible with the existing multichannel audio systems that incorporate DTS Digital Surround.

■ DTS-HD Master Audio

DTS-HD Master Audio is an advanced lossless audio technology developed for high-definition disc-based media including HD DVD and Blu-ray Disc. Selected as a mandatory audio standard for both HD DVD and Blu-ray Disc, this technology delivers sound that is bit-for-bit identical to the studio master, offering a high-definition home theater experience. Supporting bitrates up to 18.0 Mbps for HD DVD and up to 24.5 Mbps for Blu-ray Disc, DTS-HD Master Audio can carry up to 7.1 discrete channels of 24-bit/96 kHz audio simultaneously. Supported by HDMI version 1.3 and designed for the optical disc players and AV receivers/amplifiers of the future, DTS-HD Master Audio also remains fully compatible with the existing multichannel audio systems that incorporate DTS Digital Surround.

■ HDMI

HDMI (High-Definition Multimedia Interface) is the first industry-supported, uncompressed, all-digital audio/video interface. Providing an interface between any source (such as a set-top box or AV receiver) and an audio/video monitor (such as a digital television), HDMI supports standard, enhanced or high-definition video as well as multi-channel digital audio using a single cable. HDMI transmits all ATSC HDTV standards and supports 8-channel digital audio, with bandwidth to spare to accommodate future enhancements and requirements.

When used in combination with HDCP (High-bandwidth Digital Content Protection), HDMI provides a secure audio/video interface that meets the security requirements of content providers and system operators. For further information on HDMI, visit the HDMI website at “<http://www.hdmi.org/>”.

■ LFE 0.1 channel

This channel reproduces low-frequency signals. The frequency range of this channel is from 20 Hz to 120 Hz. This channel is counted as 0.1 because it only enforces a low-frequency range compared to the full-range reproduced by the other 5/6 channels in Dolby Digital or DTS 5.1/6.1-channel systems.

■ MP3

One of the audio compression methods used by MPEG. It employs the irreversible compression method, which achieves a high compression rate by thinning out the data of hardly audible part to the human ears. It is said to be capable of compressing the data quantity by about 1/11 (128 kbps) while maintaining a similar audio quality to music CD.

■ MPEG-4 AAC

An MPEG-4 audio standard. As it allows compression of data at a bit rate lower than that of MPEG-2 AAC, it is used among others for mobile telephones, portable audio players and other low-capacity devices requiring high sound quality. In addition to the above types of devices, MPEG-4 AAC is also used to distribute contents on the Internet, and as such is supported by computers, media servers and many other devices.

■ Neo:6

Neo:6 decodes the conventional 2-channel sources for 6-channel playback by the specific decoder. It enables playback with the full-range channels with higher separation just like digital discrete signal playback. There are two modes available: "Music mode" for music sources and "Cinema mode" for movie sources.

■ Neural-THX Surround

"Neural-THX" Surround is taking surround sound to the next level. This revolutionary new technology delivers the rich envelopment and discrete image detail of surround sound in a format that is fully compatible with stereo. Neural-THX Surround reduces the bandwidth needed for broadcasters to deliver true, multi-channel surround presentations, and enables 7.1-channel support for gaming and movies. By unmasking the audio details, typically lost by other playback systems, audiences will experience the deep ambience and subtle details of movies, music and games. And with this technology being used by sound designers during content creation, as well as embedded into playback devices, Neural-THX Surround promises a listening experience that is true to the original mix. Neural-THX Surround has been chosen as the official surround sound broadcast format for XM Satellite Radio's "XM HD Surround", as well as other leading FM/HD radio stations worldwide. For additional information, please visit <http://www.neuralsurround.com/>.

■ PCM (Linear PCM)

Linear PCM is a signal format under which an analog audio signal is digitized, recorded and transmitted without using any compression. This is used as a method of recording CDs and DVD audio. The PCM system uses a technique for sampling the size of the analog signal per very small unit of time. Standing for "Pulse Code Modulation", the analog signal is encoded as pulses and then modulated for recording.

■ Sampling frequency and number of quantized bits

When digitizing an analog audio signal, the number of times the signal is sampled per second is called the sampling frequency, while the degree of fineness when converting the sound level into a numeric value is called the number of quantized bits. The range of rates that can be played back is determined based on the sampling rate, while the dynamic range representing the sound level difference is determined by the number of quantized bits. In principle, the higher the sampling frequency, the wider the range of frequencies that can be played back, and the higher the number of quantized bits, the more finely the sound level can be reproduced.

■ SRS CS II (SRS Circle Surround II™)

SRS CS II (SRS Circle Surround II) is a high-performance 6.1 channel matrix surround sound decoding system. It is the next-generation of the original SRS Circle Surround technology, incorporating powerful industry-first features including the dialog clarity enhancement technology and added cinema-like bass to the front channels and subwoofer.

■ S-video signal

With the S-video signal system, the video signal normally transmitted using a pin cable is separated and transmitted as the Y signal for the luminance and the C signal for the chrominance through the S-video cable. Using the S VIDEO jack eliminates video signal transmission loss and allows recording and playback of even more beautiful images.

■ WAV

Windows standard audio file format, which defines the method of recording the digital data obtained by converting audio signals. It does not specify the compression (coding) method so a desired compression method can be used with it. By default, it is compatible with the PCM method (no compression) and some compression methods including the ADPCM method.

■ WMA

An audio compression method developed by Microsoft Corporation. It employs the irreversible compression method, which achieves a high compression rate by thinning out the data of hardly audible part to the human ears. It is said to be capable of compressing the data quantity by about 1/22 (64 kbps) while maintaining a similar audio quality to music CD.

■ "x.v.Color"

A color space standard supported by HDMI version 1.3. It is a more extensive color space than sRGB, and allows the expression of colors that could not be expressed before. While remaining compatible with the color gamut of sRGB standards, "x.v.Color" expands the color space and can thus produce more vivid, natural images. It is particularly effective for still pictures and computer graphics.

Sound field program information

■ Elements of a sound field

What really creates the rich, full tones of a live instrument are the multiple reflections from the walls of the room. In addition to making the sound live, these reflections enable us to tell where the player is situated as well as the size and shape of the room in which we are sitting. There are two distinct types of sound reflections that combine to make up the sound field in addition to the direct sound coming straight to our ears from the player's instrument.

Early reflections

Reflected sounds reach our ears extremely rapidly (50 ms to 100 ms after the direct sound), after reflecting from one surface only (for example, from a wall or the ceiling). Early reflections actually add clarity to the direct sound.

Reverberations

These are caused by reflections from more than one surface (for example, from the walls, and/or the ceiling) so numerous that they merge together to form a continuous sonic afterglow. They are non-directional and lessen the clarity of the direct sound.

Direct sound, early reflections and subsequent reverberations taken together help us to determine the subjective size and shape of the room, and it is this information that the digital sound field processor reproduces in order to create sound fields.

If you could create the appropriate early reflections and subsequent reverberations in your listening room, you would be able to create your own listening environment. The acoustics in your room could be changed to those of a concert hall, a dance floor, or a room with virtually any size at all. This ability to create sound fields at will is exactly what Yamaha has done with the digital sound field processor.

■ CINEMA DSP

Since the Dolby Surround and DTS systems were originally designed for use in movie theaters, their effect is best felt in a theater having many speakers designed for acoustic effects. Since home conditions, such as room size, wall material, number of speakers, and so on, can differ so widely, it is inevitable that there are differences in the sound heard. Based on a wealth of actually measured data, Yamaha CINEMA DSP provides the audiovisual experience of a movie theater in the listening room of your own home by using the Yamaha original sound field technology combined with various digital audio systems.

■ CINEMA DSP 3D

The actually measured sound field data contain the information of the height of the sound images. CINEMA DSP 3D feature achieves the reproduction of the accurate height of the sound images so that it creates the accurate and intensive stereoscopic sound fields in a listening room.

■ SILENT CINEMA

Yamaha has developed a natural, realistic sound effect DSP algorithm for headphones. Parameters for headphones have been set for each sound field so that accurate representations of all the sound field programs can be enjoyed on headphones.

■ Virtual CINEMA DSP

Yamaha has developed a Virtual CINEMA DSP algorithm that allows you to enjoy DSP sound field surround effects even without any surround speakers by using virtual surround speakers. It is even possible to enjoy Virtual CINEMA DSP using a minimal two-speaker system that does not include a center speaker.

■ Compressed Music Enhancer

The Compressed Music Enhancer feature of this unit enhances your listening experience by regenerating the missing harmonics in a compression artifact. As a result, flattened complexity due to the loss of high-frequency fidelity as well as lack of bass due to the loss of low-frequency bass is compensated, providing improved performance of the overall sound system.

Parametric equalizer information

This unit employs Yamaha Parametric room Acoustic Optimizer (YPAO) technology to optimize the frequency characteristics of its parametric equalizer to match your listening environment. YPAO uses a combination of the following three parameters (Frequency, Gain and Q factor) to provide highly precise adjustment of the frequency characteristics.

■ Frequency

This parameter is adjustable in one-third octave increments between 32 Hz and 16 kHz.

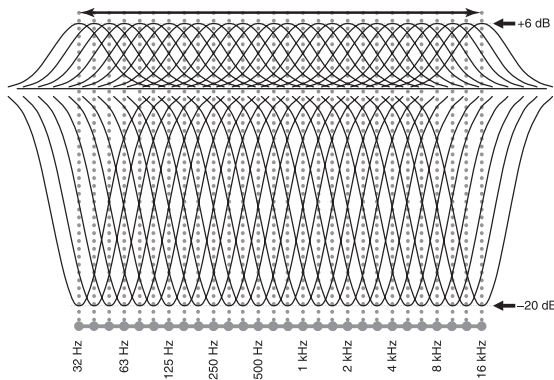

■ Gain

This parameter is adjustable in increments of 0.5 dB between -20 and +6 dB.

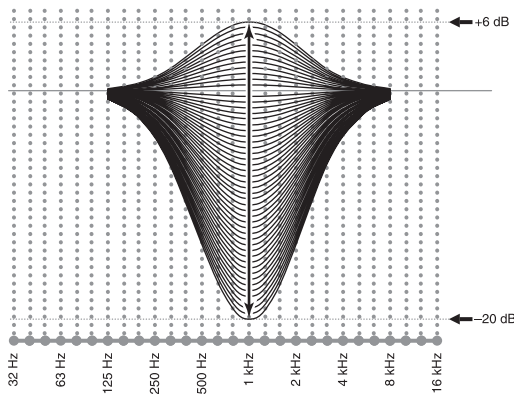

■ Q factor

The width of the specified frequency band is referred to as the Q factor. This parameter is adjustable between the values 0.5 and 10.

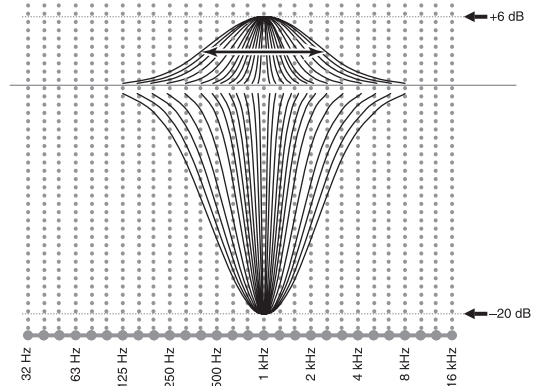

YPAO adjusts frequency characteristics to suit your listening requirements using a combination of the above three parameters (Frequency, Gain and Q factor) for each equalizer band in this unit's parametric equalizer. This unit has 7 equalizer bands for each channel.

The use of multiple equalizer bands enables more precise adjustments of frequency characteristics (as in Figure 2). This is not possible using only a single equalizer band (as in Figure 1).

Figure 1

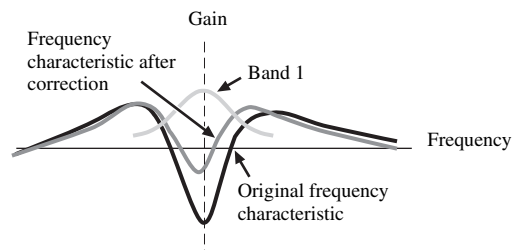
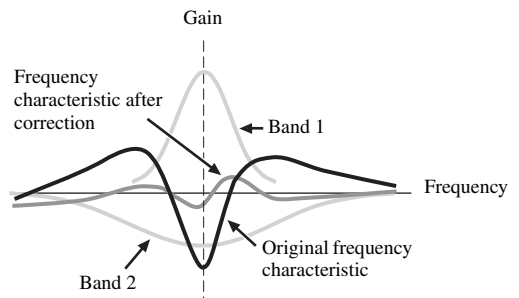

Figure 2



Specifications

AUDIO SECTION

- Minimum RMS Output Power for Front, Center, Surround, Surround back
20 Hz to 20 kHz, 0.04% THD, 8 Ω 140 W
- Dynamic Power (IHF)
[U.S.A., Canada, General, Asia, China, Korea, and Australia models]
Front L/R 8/6/4/2 Ω 170/205/265/345 W
- Maximum Useful Output Power (JEITA)
[Asia, General, China and Korea models]
1 kHz, 10% THD, 8 Ω 185 W
- Maximum Output Power [U.K. and Europe models]
1 kHz, 0.7% THD, 4 Ω 200 W
- Dynamic Headroom
8 Ω 0.84 dB
- IEC Output Power [U.K. and Europe models]
Front L/R 1 kHz, 0.04% THD, 8 Ω 145 W
- Damping Factor (IHF)
Front L/R 20 Hz to 20 kHz, 8 Ω 150 or more
- Input Sensitivity/Input Impedance
PHONO 3.5 mV/47 kΩ
CD, etc. 200 mV/47 kΩ
MULTI CH INPUT 200 mV/47 kΩ
- Maximum Input Voltage
PHONO (1 kHz, 0.1% THD) 60 mV or more
CD, etc. (1 kHz, 0.5% THD) 2.4 V or more
- Rated Output Voltage/Output Impedance
OUT (REC) 200 mV/900 Ω
PRE OUT 1.0 V/500 Ω
SUBWOOFER 1.0 V/1.2 kΩ
ZONE 2/ZONE 3 OUT 1.0 V/1.4 kΩ
- Headphone Jack Rated Output/Impedance
CD, etc. (1 kHz, 40 mV, 8 Ω) 150 mV/100 Ω
- Frequency Response
CD to Front L/R, Pure Direct 10 Hz to 100 kHz, +0/-3 dB
- RIAA Equalization Deviation
PHONO (20 Hz to 20 kHz) 0 ± 0.5 dB
- Total Harmonic Distortion
PHONO to OUT (REC)
(20 Hz to 20 kHz, 1 V) 0.02% or less
CD, etc. to Front L/R
(20 Hz to 20 kHz, 70 W, 8 Ω) 0.04% or less
- Signal to Noise Ratio (IHF-A Network)
PHONO (5 mV) to Front L/R
[Australia, U.K. and Europe models] 81 dB or more
[Other models] 86 dB or more
CD, etc. (250 mV) to Front L/R 100 dB or more
- Residual Noise (IHF-A Network)
Front L/R 150 μV or less
- Channel Separation (1 kHz/10 kHz)
PHONO (shortened) to Front L/R 60 dB/55 dB or more
CD, etc. (5.1 kΩ shortened) to Front L/R 60 dB/45 dB or more

- Tone Control (Front L/R, Center, Subwoofer)
BASS Boost/Cut ±6 dB/50 Hz
BASS Turnover Frequency 350 Hz
TREBLE Boost/Cut ±6 dB/20 kHz
TREBLE Turnover Frequency 3.5 kHz
- Zone 2/Zone 3 Tone Control
BASS Boost/Cut ±10 dB/100 Hz
BASS Turnover Frequency 450 Hz
TREBLE Boost/Cut ±10 dB/10 kHz
TREBLE Turnover Frequency 2.0 kHz
- Filter Characteristics (fc=40/60/80/90/100/110/120/160/200 Hz)
H.P.F. (Front, Center, Surround, Surround Back, Presence: Small)
..... 12 dB/oct.
L.P.F. (Subwoofer) 24 dB/oct.

VIDEO SECTION

- Video Format [MONITOR OUT] (Wall Paper)
[U.S.A., Canada, General and Korea models] NTSC/PAL
[U.K., Europe, Australia, Asia and China models] PAL/NTSC
- Video Format (Video Conversion)
.....NTSC/PAL
- Signal Level
Composite 1 Vp-p/75 Ω
S-video 1 Vp-p/75 Ω (Y), 0.286 or 0.3 Vp-p/75 Ω (C)
Component 1 Vp-p/75 Ω (Y), 0.7 Vp-p/75 Ω (Pb/Pk)
- Maximum Input Level (Video Conversion Off)
..... 1.5 Vp-p or more
- Signal to Noise Ratio (Video Conversion Off)
..... 60 dB or more
- Frequency Response [MONITOR OUT]
Component (Video Conversion Off)
..... 5 Hz to 100 MHz, ±3 dB
- Video Format [ZONE OUT] (Gray Back)
[U.S.A., Canada, General and Korea models] NTSC
[U.K., Europe, Australia, Asia and China models] PAL

FM SECTION

- Tuning Range
[U.S.A. and Canada models] 87.5 to 107.9 MHz
[Asia and General models] 87.5/87.50 to 108.0/108.00 MHz
[Other models] 87.50 to 108.00 MHz
- 50 dB Quieting Sensitivity (IHF)
Mono/Stereo 2.0/25 μV (17.3/39.2 dBf)
- Usable Sensitivity (IHF) 1.0 μV (11.2 dBf)
- Selectivity (400 kHz) 70 dB
- Signal to Noise Ratio (IHF)
Mono/Stereo 76 dB/70 dB
- Harmonic Distortion (1 kHz)
Mono/Stereo 0.2/0.3%
- Stereo Separation (1 kHz)
Stereo 42 dB
- Frequency Response
Stereo 20 Hz to 15 kHz, +0.5, -2 dB
- Antenna Input (unbalanced) 75 Ω

AM SECTION

- Tuning Range
[U.S.A. and Canada models] 530 to 1710 kHz
[Asia and General models] 530/531 to 1710/1611 kHz
[Other models] 531 to 1611 kHz
- Usable Sensitivity 300 µV/m

GENERAL

- Power Supply
[U.S.A. and Canada models] AC 120 V, 60 Hz
[General and Asia models] AC 110/120/220/230–240 V, 50/60 Hz
[China model] AC 220 V, 50 Hz
[Korea model] AC 220 V, 60 Hz
[Australia model] AC 240 V, 50 Hz
[U.K. and Europe models] AC 230 V, 50 Hz
- Power Consumption
[U.S.A. and Canada models] 500 W/630 VA
[Other models] 500 W
- Standby Power Consumption
[General model] (AC 240 V, 50 Hz) 0.33 W or less
[Other models] 0.1 W or less
- Maximum Power Consumption [General model]
6ch, 10% THD 1100 W
- AC Outlets
[U.S.A. and Canada models] 2 (Total 100 W/0.8 A maximum)
[Asia and General models] 2 (Total 50 W maximum)
[China model] 2 (Total 100 W maximum)
[Australia model] 1 (100 W maximum)
[U.K. model] 1 (100 W/0.4 A maximum)
[Europe model] 2 (Total 100 W/0.4 A maximum)
- Dimensions (W x H x D) 435 x 181 x 438.5 mm
(17-1/8 x 7-1/8 x 17-1/4 in)
- Weight
[China model] 19.0 kg (41 lbs 14 oz)
[Other models] 17.4 kg (38 lbs 6 oz)

* Specifications are subject to change without notice.

(U.S.A. model only)
There is a HOT SURFACE label attached to the top surface of this unit. This label is required to be attached to a product of which the temperature of the top cover may rise 40°C or more during operation (ambient temperature: 25°C).

COMPLIANCE INFORMATION STATEMENT (DECLARATION OF CONFORMITY PROCEDURE)

Responsible Party: Yamaha Electronics Corporation, U.S.A.
Address: 6660 Orangethorpe Avenue
Buena Park, CA 90620
Telephone: 714-522-9105
Fax: 714-670-0108
Type of Equipment: AV Receiver
Model Name: RX-V3900

- This device complies with Part 15 of the FCC Rules.
 - Operation is subject to the following conditions:
 - This device may not cause harmful interference.
 - This device must accept any interference received including interference that may cause undesired operation.
- See the “Troubleshooting” section at the end of this manual if interference to radio reception is suspected.

We Want You Listening For A Lifetime



Yamaha and the Electronic Industries Association’s Consumer Electronics Group want you to get the most out of your equipment by playing it at a safe level. One that lets the sound come through loud and clear without annoying blaring or distortion – and, most importantly, without affecting your sensitive hearing. Since hearing damage from loud sounds is often undetectable until it is too late, Yamaha and the Electronic Industries Association’s Consumer Electronics Group recommend you to avoid prolonged exposure from excessive volume levels.

Index

■ Numerics

2ch Stereo, sound field program	45
3D indicator	27
5.1-channel speaker connection	13
5.1-channel speaker layout	10
6.1-channel speaker connection	13
6.1-channel speaker layout	10
7.1-channel speaker connection	12
7.1-channel speaker layout	10
7ch Enhancer, sound field program	45
7ch Stereo, sound field program	45

■ A

AC OUTLET(S)	25
AC power cable connection	25
Action Game, sound field program	43
Activating SIRIUS Satellite Radio subscription	59
Activating XM Satellite Radio	54
ADAPTIVE DRC indicator	27
Adaptive DRC, GUI menu	89
Adaptive DSP effect level, GUI menu	89
Adaptive DSP Level, GUI menu	89
Adaptive dynamic range control, GUI menu	89
Advanced automatic setup	33
Advanced setup	121
Advanced sound configuration	74
Adventure, sound field program	44
All Channel Search mode, Sirius Satellite Radio	60
All Channel Search mode, XM Radio	54
AM antenna connection	24
AM tuner, troubleshooting	128
AM tuning	48
AM tuning operation	48
AMP, operation mode selector	29
Analog ▶ Analog, GUI menu	93
Analog ▶ HDMI, GUI menu	93
Analog Resolution, input video information	39
Analog-to-analog video conversion, GUI menu	93
ANTENNA terminals	9
Aspect, GUI menu	94
Audio and video synchronization, GUI menu	92
Audio input jack selection	37
Audio input jack selection, GUI menu	85
AUDIO jacks	15
Audio jacks	15
Audio Output, GUI menu	95
AUDIO SELECT	37
Audio Select, GUI menu	85, 99
Audio signal flow	17
Audio signals, HDMI	16
Auto Bypass, GUI menu	92

Automatic audio delay adjustment, GUI menu	92
Automatic setup, troubleshooting	136
Automatic station preset, FM/AM tuning	49

■ B

Back ground video, GUI menu	86
Banana plug connection	14
Bass Out, GUI menu	88
Bass, GUI menu	92
BGV, GUI menu	86
BI-AMP, advanced setup	122
Bi-amplification connections	14
Bi-amplifier mode, advanced setup	122
Bitrate, input audio information	38
Bluetooth component playback	64
Bluetooth connection, GUI menu	87
Bluetooth pairing, GUI menu	86
Bluetooth wireless audio receiver connection	22
Bluetooth, troubleshooting	135
Blu-ray Disc player connection	20

■ C

Category Search mode, Sirius Satellite Radio	60
Category Search mode, XM Radio	54
CD player connection	21
CD recorder connection	21
Cellar Club, sound field program	42
Center Image, decoder parameter	84
CENTER jack	22
Center Level, sound field parameter	83
CENTER PRE OUT jack	21
Center speaker	11
Center speaker, GUI menu	87
Center Width, decoder parameter	84
Center, GUI menu	87
Chamber, sound field program	42
Channel Mute, GUI menu	93
Channel, input audio information	38
Church in Freiburg, sound field program	42
CINEMA DSP 3D mode	46
CINEMA DSP indicator	27
CLASSICAL, sound field program	41
Clearing configurations, remote control	115
Clearing preset channel, Sirius Satellite Radio	61
Clearing preset channels, XM Radio	56
Clearing preset stations, FM/AM tuning	50
COAXIAL jacks	15
COMPONENT VIDEO jacks	15
Compressed Music Enhancer mode	45
Configuration, GUI menu	87, 95
Connect, GUI menu	87
Connecting AC power cable	25

Connecting AM antenna	24
Connecting banana plug	14
Connecting Bluetooth receiver	22
Connecting Blu-ray Disc player	20
Connecting CD player	21
Connecting CD recorder	21
Connecting DVD player	20
Connecting DVD recorder	20
Connecting FM antenna	24
Connecting HD DVD player	20
Connecting iPod universal dock	22
Connecting MD recorder	21
Connecting power cable	25
Connecting projector	18
Connecting set-top box	20
Connecting SiriusConnect tuner	58
Connecting speaker cable	14
Connecting speakers	12
Connecting surround table	21
Connecting TV monitor	18
Connecting VCR	21
Connecting XM Mini-Tuner Home Dock	53
Connecting YBA-10	22
Connecting YDS-11	22
Connecting Zone 2/3 components	117
Connections	9
Control Monitor, GUI menu	95
Control, GUI menu	92
Controlling iPod	67
Controlling other components, remote control	107
Controlling TV, remote control	106
Controlling Zone 2/3	119
Cross Over, GUI menu	88
CSII Cinema, decoder	74
CSII indicator	27
CSII Music, decoder	74

■ D

Decoder descriptions	74
Decoder indicators	27
Decoder Mode, GUI menu	85, 99
Decoder selection	74
Decoder Type, sound field parameter	81
Default Gateway, GUI menu	95
Device Over, HDMI error message	39
DHCP, GUI menu	95
Dialogue Lift, sound field parameter	80
Dialogue, input audio information	38
DIGITAL INPUT jacks	9
DIGITAL OUTPUT jacks	9
Dimension, decoder parameter	84
Dimmer, GUI menu	98
Direct frequency tuning, FM/AM tuning	48
Direct number access mode, Sirius Satellite Radio	60

- Direct number access mode,
 - XM Radio 55
 - Direct, sound field parameter 83
 - Display information,
 - Sirius Satellite Radio 63
 - Display language setting 26
 - Display Set, GUI menu 98
 - Display settings, GUI menu 98
 - Display window, remote control 28
 - Displaying information, HD Radio 52
 - Displaying information, XM radio 56
 - Displaying input source information 38, 40
 - Distance, automatic setup 32
 - Distance, GUI menu 88
 - DNS Server (P), GUI menu 96
 - DNS Server (S), GUI menu 96
 - Drama, sound field program 44
 - DSP indicators 27
 - DSP Level, sound field parameter 80
 - DVD player connection 20
 - DVD recorder connection 20
 - Dynamic Range, GUI menu 90
- E**
- Effect sound level,
 - sound field parameter 80
 - ENHANCER indicator 27
 - ENHANCER, sound field program 45
 - ENTERTAIN, sound field program 43
 - Equalizing, automatic setup 32
 - EXTD Surround, GUI menu 99
 - External amplifier connection 21
- F**
- F.PRNS L Level,
 - sound field parameter 83
 - F.PRNS R Level,
 - sound field parameter 83
 - FIRM UPDATE, advanced setup 123
 - Flag1/Flag2,
 - input audio information 38
 - FM antenna connection 24
 - FM tuner, troubleshooting 128
 - FM tuning 48
 - FM tuning operation 48
 - FOCUS, decoder parameter 84
 - Format, input audio information 38
 - Front channel output jacks 21
 - Front Input, GUI menu 86
 - FRONT L/R jacks 22
 - Front left and right channels input
 - jacks, GUI menu 86
 - Front left/right speaker 11
 - Front panel display message scroll,
 - GUI menu 98
 - Front panel door 29
 - FRONT PRE OUT jacks 21
 - Front presence speakers, GUI menu 88
 - Front Presence, GUI menu 88
 - Front speakers, GUI menu 87
 - Front, GUI menu 87
- G**
- GUI menu operation 79
 - GUI menu tree 76
 - GUI screen position, GUI menu 99
- H**
- Hall in Amsterdam,
 - sound field program 42
 - Hall in Munich, sound field program 41
 - Hall in Vienna, sound field program 41
 - HD DVD player connection 20
 - HD Radio 51
 - HD Radio, troubleshooting 128
 - HDCP Error, HDMI error message 39
 - HDMI ► HDMI, GUI menu 94
 - HDMI aspect ratio, GUI menu 94
 - HDMI automatic lip sync mode,
 - GUI mode 92
 - HDMI cable plug 16
 - HDMI error message 39
 - HDMI Error,
 - input video information 39
 - HDMI IN jack select, GUI menu 95
 - HDMI indicator 27
 - HDMI information 16
 - HDMI jack 16
 - HDMI monitor check,
 - advanced setup 123
 - HDMI OUT jack select, GUI menu 95
 - HDMI OUT jack selection 37
 - HDMI Resolution,
 - input video information 39
 - HDMI signal 16
 - HDMI signal,
 - input video information 39
 - HDMI video signal processing,
 - GUI menu 94
 - HDMI video signal resolution,
 - GUI menu 94
 - HDMI, GUI menu 94
 - HDMI, troubleshooting 128
 - Headphones indicator 27
 - Headphones using 38
- I**
- I/O Assignment, GUI menu 98
 - IDI/ID2 indicator, remote control 28
 - INFORMATION 144
 - Information display, HD Radio 52
 - Information display, remote control 28
 - Information display, XM radio 56
 - Infrared window, remote control 28
 - Init. Delay, sound field parameter 81
 - Initial Set, GUI menu 99
 - Initial Volume, GUI menu 90
 - INITIALIZE, advanced setup 122
 - Input channel indicators 28
 - Input Channels, GUI menu 86
 - Input Level, GUI menu 100
 - Input Rename, GUI menu 98
 - Input Select, GUI menu 85
 - Input signal indicators 27
 - Input source indicators 27
 - Input source information display 38, 40
- Input/output assignment, GUI menu 98
 - IP Address, GUI menu 95
 - iPod charge on the standby mode,
 - GUI menu 99
 - iPod menu tree 66
 - iPod playback 66
 - iPod universal dock connection 22
 - iPod, GUI menu 99
 - iPod, troubleshooting 135
 - iTunes tagging, HD radio 51
 - iTunes Tagging, troubleshooting 129
- L**
- LANGUAGE, advanced setup 123
 - Language, advanced setup 123
 - Language, GUI menu 100
 - Level, automatic setup 32
 - Level, GUI menu 89
 - Level, music enhancer parameter 84
 - LFE Level, GUI menu 90
 - Lipsync, GUI menu 92
 - LIVE/CLUB, sound field program 42
 - Liveness, sound field parameter 82
 - Loading system settings 103
 - Loading the system settings 103
 - Low-frequency effect level,
 - GUI menu 90
- M**
- MAC address filter, advanced setup 122
 - MAC Address, GUI menu 96
 - MAC FILTER, advanced setup 122
 - Macro programming, remote control 113
 - Manual audio delay adjustment,
 - GUI menu 92
 - Manual station preset,
 - FM/AM tuning 49
 - Manual Test, GUI menu 100
 - Max Volume, GUI menu 90
 - MCX-2000 content playback 70
 - MD recorder connection 21
 - Media Access Control) address,
 - GUI menu 96
 - Menu browsing indicator 28
 - Menu tree, iPod 66
 - Menu tree, network 68
 - Menu tree, USB 68
 - MONITOR CHECK,
 - advanced setup 123
 - Monitor Info., GUI menu 95
 - Monitor information, GUI menu 95
 - Mono Movie, sound field program 44
 - MOVIE, sound field program 44
 - Multi CH Assign, GUI menu 86
 - MULTI CH INPUT jacks 9
 - Multi channel assignment,
 - GUI menu 86
 - Multi Measure, automatic setup 31
 - Multi Zone, GUI menu 96
 - Multi-channel input component
 - selection 37
 - Multi-channel sources with
 - headphones 45

- Multiple point measurement,
 - automatic setup 31
 - Multi-zone configuration 117
 - Music Content menu 65
 - Music Content, GUI menu 87
 - Music Video, sound field program 43
 - Muting audio output 38
 - Muting Type, GUI menu 90
- **N**
- Neo:6 Cinema, decoder 74
 - Neo:6 Music, decoder 74
 - Network connection 23
 - Network Standby, GUI menu 96
 - Network, GUI menu 95
 - Network, troubleshooting 133
 - neural indicator 27
 - NRL-THX Music, decoder 74
 - NRL-THX, decoder 74
- **O**
- Operation mode selector,
 - remote control 29
 - OPTICAL jacks 15
 - Optimizing speaker setting 30
 - Option, GUI menu 97
 - Out Of Resolution,
 - HDMI error message 39
- **P**
- Pairing with Bluetooth component 64
 - Pairing, GUI menu 86
 - Panorama, decoder parameter 84
 - Parameter initialization,
 - advanced setup 122
 - Parametric EQ, GUI menu 90
 - Parametric equalizer data copy,
 - GUI menu 90
 - Parametric equalizer information 144
 - Parametric equalizer type select,
 - GUI menu 91
 - Parametric equalizer, GUI menu 90
 - Parental Lock, GUI menu 86
 - Parental Lock, Sirius Satellite Radio ... 62
 - PC server content playback 70
 - PEQ Data Copy, GUI menu 90
 - PEQ Select, GUI menu 91
 - PHONES jack 38
 - Placing speakers 10
 - Play information screen,
 - iPod playback 67
 - Play information screen,
 - USB content 69
 - Playback screen display time,
 - GUI menu 98
 - Playback Screen, GUI menu 98
 - Playback style, iPod 67
 - Playback, Bluetooth component 64
 - PLII Game, decoder 74
 - PLII Movie, decoder 74
 - PLII Music, decoder 74
 - PLIIX Game, decoder 74
 - PLIIX Movie, decoder 74
 - PLIIX Music, decoder 74
 - Position, GUI menu 99
 - Power cable connection 25
 - PRE OUT jacks 9
 - Presence left / right speaker 11
 - Presence speaker indicators 28
 - Preset channel clear, XM Radio 56
 - Preset channel setting,
 - Sirius Satellite Radio 61
 - Preset channel setting, XM Radio 55
 - PRESET indicator 27
 - Preset Search mode,
 - Sirius Satellite Radio 60
 - Preset Search mode, XM Radio 55
 - Preset stations, FM/AM tuner 49
 - Primary DNS server, GUI menu 96
 - Pro Logic, decoder 74
 - Processing, GUI menu 94
 - Prog. Re-Processing, GUI menu 94
 - Program selection, HD Radio 51
 - Programming other remote controls ... 111
 - Progressive re-processing,
 - GUI menu 94
 - Projector connection 18
 - PURE DIRECT mode 47
 - Pure Direct, GUI menu 93
 - Pure hi-fi sound listening 47
- **R**
- Rear panel 9
 - Recalling a preset station,
 - FM/AM tuning 50
 - Recital/Opera, sound field program 43
 - RECOV./BACKUP, advanced setup 122
 - Recovery and backup of the system
 - settings,
 - advanced setup 122
 - Reloading automatic setup
 - parameter 34
 - REMOTE CON AMP,
 - advanced setup 121
 - Remote control 106
 - Remote control code setting 109
 - Remote control customization 108
 - Remote control ID setting,
 - advanced setup 121
 - Remote control using 28
 - Remote control, installing batteries 4
 - Remote control, troubleshooting 132
 - REMOTE IN/OUT jacks 22
 - REMOTE SENSOR,
 - advanced setup 121
 - Remote sensor, advanced setup 121
 - Repeat, iPod playback style 67
 - Resetting system 138
 - Resolution, GUI menu 94
 - Rev. Delay, sound field parameter 83
 - Rev. Level, sound field parameter 83
 - Rev. Time, sound field parameter 82
 - Reviewing automatic setup
 - parameter 34
 - Rhapsody® service 71
 - Roleplaying Game,
 - sound field program 43
 - Room Size, sound field parameter 81
 - RS-232C STANDBY,
 - advanced setup 121
- **S**
- S VIDEO jacks 15
 - Sampling, input audio information 38
 - Saving system settings 101
 - SB. Init. Delay,
 - sound field parameter 81
 - SB. Liveness, sound field parameter ... 82
 - SB. Room Size,
 - sound field parameter 81
 - Sci-Fi, sound field program 44
 - Scroll, GUI menu 98
 - Secondary DNS server, GUI menu 96
 - Selecting audio input jacks 37
 - Selecting decoder 74
 - Selecting multi-channel input
 - component 37
 - Setting preset channels, XM Radio 55
 - Setting remote control ID,
 - remote control ID setting 121
 - Set-top box connection 20
 - Setup, GUI menu 87
 - Short Message, GUI menu 98
 - Shortcut button,
 - Network content playback 72
 - Shortcut button,
 - USB content playback 72
 - Shuffle, iPod playback style 67
 - Signal flow 17
 - SIGNAL INFO 38, 40
 - SILENT CINEMA 45
 - SILENT CINEMA indicator 27
 - Simple Remote Mode,
 - iPod playback 67
 - Simplified remote control 116
 - Sirius ID display 59
 - SIRIUS PIN, advanced setup 122
 - SIRIUS Satellite Radio operation 59
 - SIRIUS Satellite Radio Parental Lock
 - code number reset,
 - advanced setup 122
 - SIRIUS Satellite Radio parental lock,
 - GUI menu 86
 - SIRIUS Satellite Radio subscription
 - activation 59
 - SIRIUS Satellite Radio tuning 58
 - SIRIUS Satellite Radio,
 - troubleshooting 131
 - SiriusConnect tuner connection 58
 - Size, automatic setup 32
 - SLEEP indicator 28
 - Sleep timer 39
 - Sound field parameter 81
 - Sound field program information 143
 - Sound field programs 40
 - Sound field programs with
 - headphones 45
 - Sound field programs without
 - surround speaker 45
 - Sound, GUI menu 90
 - Source name change,
 - remote control 112

- SOURCE, operation mode selector 29
- Speaker cable connection 14
- Speaker configurations, GUI menu 87
- Speaker connection 12
- Speaker distance, automatic setup 32
- Speaker distance, GUI menu 88
- Speaker equalizing, automatic setup 32
- SPEAKER IMP., advanced setup 121
- Speaker impedance setting 26
- Speaker impedance, advanced setup ... 121
- Speaker level adjustment 47
- Speaker level, automatic setup 32
- Speaker level, GUI menu 89
- Speaker placement 10
- Speaker setting oprimization 30
- Speaker size, automatic setup 32
- Speaker terminals 9
- Speaker wiring, automatic setup 31
- Speaker, GUI menu 87
- Specifications 145
- Spectacle, sound field program 44
- Sports, sound field program 43
- Standard, sound field program 44
- Standby Charge, GUI menu 99
- Standby mode 26
- Standby Through, GUI menu 94
- Station Search, GUI menu 86
- Status, GUI menu 96
- Stereo playback 45
- STEREO, sound field program 45
- Stereo/Surround, GUI menu 80
- Straight Enhancer,
sound field program 45
- STRAIGHT mode 46
- Subnet Mask, GUI menu 95
- Subwoofer 11
- SUBWOOFER jack 22
- SUBWOOFER PRE OUT jack 22
- Subwoofer, GUI menu 88
- Supplied accessories 3
- SUR. DECODE,
sound field program 45
- Sur. Init.Delay,
sound field parameter 81
- Sur. Liveness, sound field parameter .. 82
- Sur. Room Size,
sound field parameter 81
- Sur.Back L Level,
sound field parameter 83
- Sur.Back R Level,
sound field parameter 83
- SUR.BACK/PRESENCE PRE OUT
jacks 22
- Surround back left/right speaker 11
- Surround back left/right speakers,
GUI menu 88
- Surround back speaker 11
- Surround Back, GUI menu 88
- Surround Decode,
sound field program 45
- Surround decoder mode 45
- Surround L Level,
sound field parameter 83
- SURROUND L/R jacks 22
- Surround left / right speaker 11
- Surround left/right speakers,
GUI menu 87
- SURROUND PRE OUT jacks 21
- Surround R Level,
sound field parameter 83
- Surround, GUI menu 87
- System ID, GUI menu 96
- System Memory 101
- System reset 138
- System settings 101
- System, GUI menu 96
- **T**
- Target Zone, GUI menu 100
- The Bottom Line,
sound field program 42
- The Roxy Theatre,
sound field program 42
- Tonal quality adjustment 47
- Tone Control, GUI menu 92
- Treble, GUI menu 92
- Trigger Mode, GUI menu 100
- Trigger Output, GUI menu 100
- Troubleshooting 124
- TruBass, decoder parameter 84
- Tuner frequency step,
advanced setup 122
- TUNER FRQ STEP,
advanced setup 122
- Tuner indicators 28
- Turning off 26
- Turning on 26
- Turntable connection 21
- TV FORMAT, advanced setup 123
- TV format, advanced setup 123
- TV monitor connection 18
- TV, operation mode selector 29
- **U**
- Unit, GUI menu 88
- Unprocessed input source listening 46
- USB content playback 68
- USB device that can be used 69
- USB storage device connection 23
- USB, troubleshooting 133
- **V**
- VCR connection 21
- VERSION, advanced setup 123
- Vertical dialogue position,
sound field parameter 80
- VIDEO AUX jacks 24
- Video conversion for analog-to-analog,
GUI menu 93
- VIDEO jacks 15
- Video jacks 15
- Video signal flow 17
- Video signals, HDMI 16
- Video, GUI menu 93
- Village Vanguard,
sound field program 42
- Virtual CINEMA DSP 45
- VIRTUAL indicator 27
- VOLTAGE SELECTOR 4
- VOLUME level indicator 28
- Volume Trim, GUI menu 85
- Volume, GUI menu 89
- **W**
- Wake on RS-232C access,
advanced setup 121
- Wall Paper, GUI menu 99
- Warehouse Loft,
sound field program 42
- Web browser controlling 105
- Web Control Center 105
- Wiring, automatic setup 31
- **X**
- XM Mini-Tuner Home Dock
connection 53
- XM Satellite Radio activation 54
- XM Satellite Radio operations 54
- XM Satellite Radio tuning 53
- XM Satellite Radio,
troubleshooting 130
- **Y**
- YBA-10 connection 22
- YDS-11 connection 22
- YPAO 30
- YPAO indicator 27
- **Z**
- Zone 2/3 component connection 117
- Zone 2/3 control 119
- Zone indicators, remote control 28
- Zone on-screen display, GUI menu 97
- Zone OSD, GUI menu 97
- ZONE OUT jacks 9
- Zone Rename, GUI menu 97
- Zone SP Assign, GUI menu 96
- Zone speaker assignment,
GUI menu 96
- Zone2 Balance, GUI menu 97
- Zone2 Initial Vol., GUI menu 97
- Zone2 Max Vol., GUI menu 97
- Zone2 Muting Type, GUI menu 97
- Zone2 Set, GUI menu 96
- Zone2 Volume, GUI menu 96
- ZONE2/ZONE3 indicators 28
- Zone3 Balance, GUI menu 97
- Zone3 Initial Vol., GUI menu 97
- Zone3 Max Vol., GUI menu 97
- Zone3 Muting Type, GUI menu 97
- Zone3 Set, GUI menu 96
- Zone3 Tone Control, GUI menu 97
- Zone3 Volume, GUI menu 96

“**Ⓐ** MASTER ON/OFF” or
“**Ⓑ** DVD” (example) indicates the
name of the parts on the front panel
or the remote control. Refer to the
attached sheet or the pages at the
end of this manual for the
information about each position of
the parts.

■ Front panel

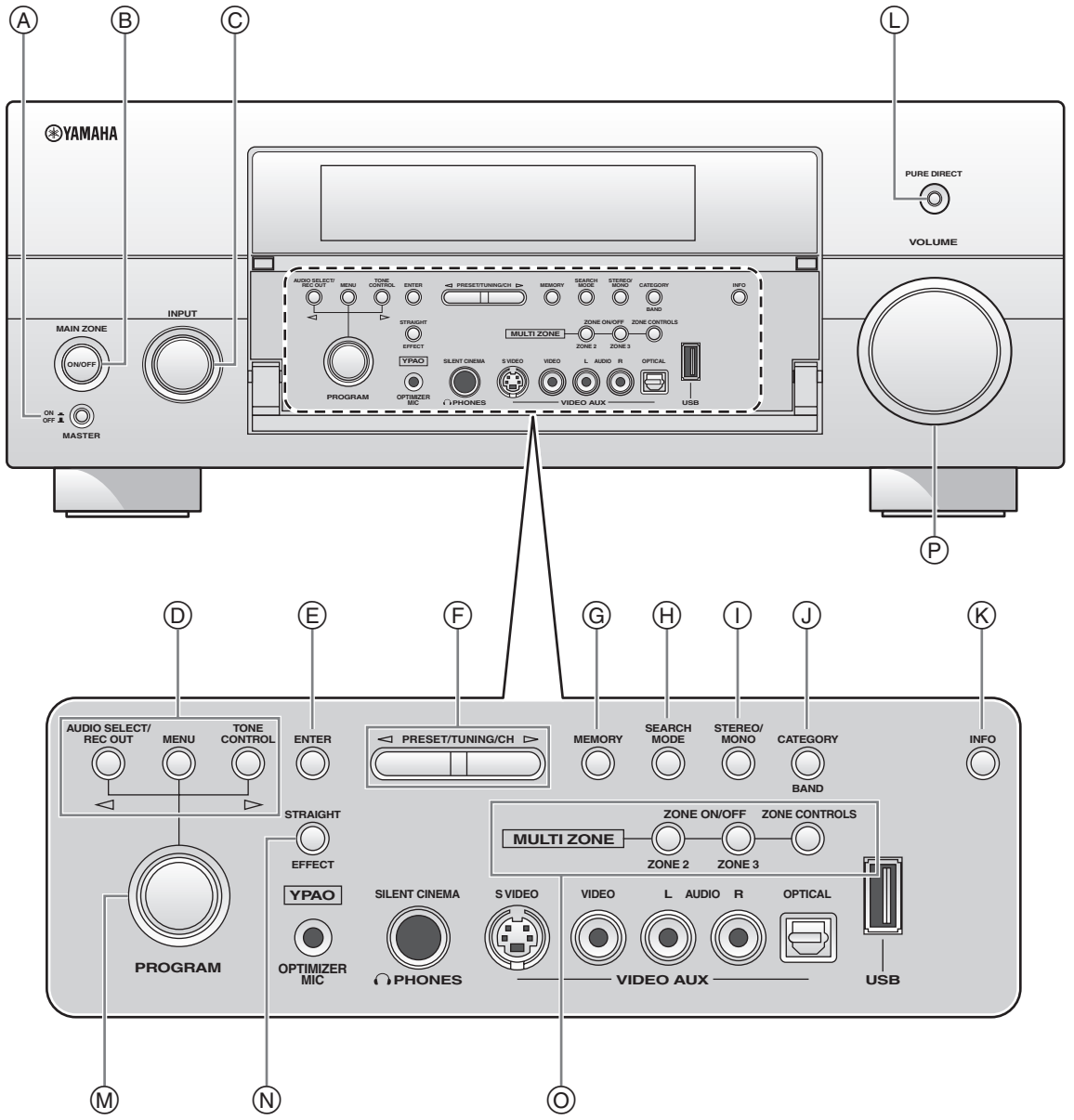

■ Remote control

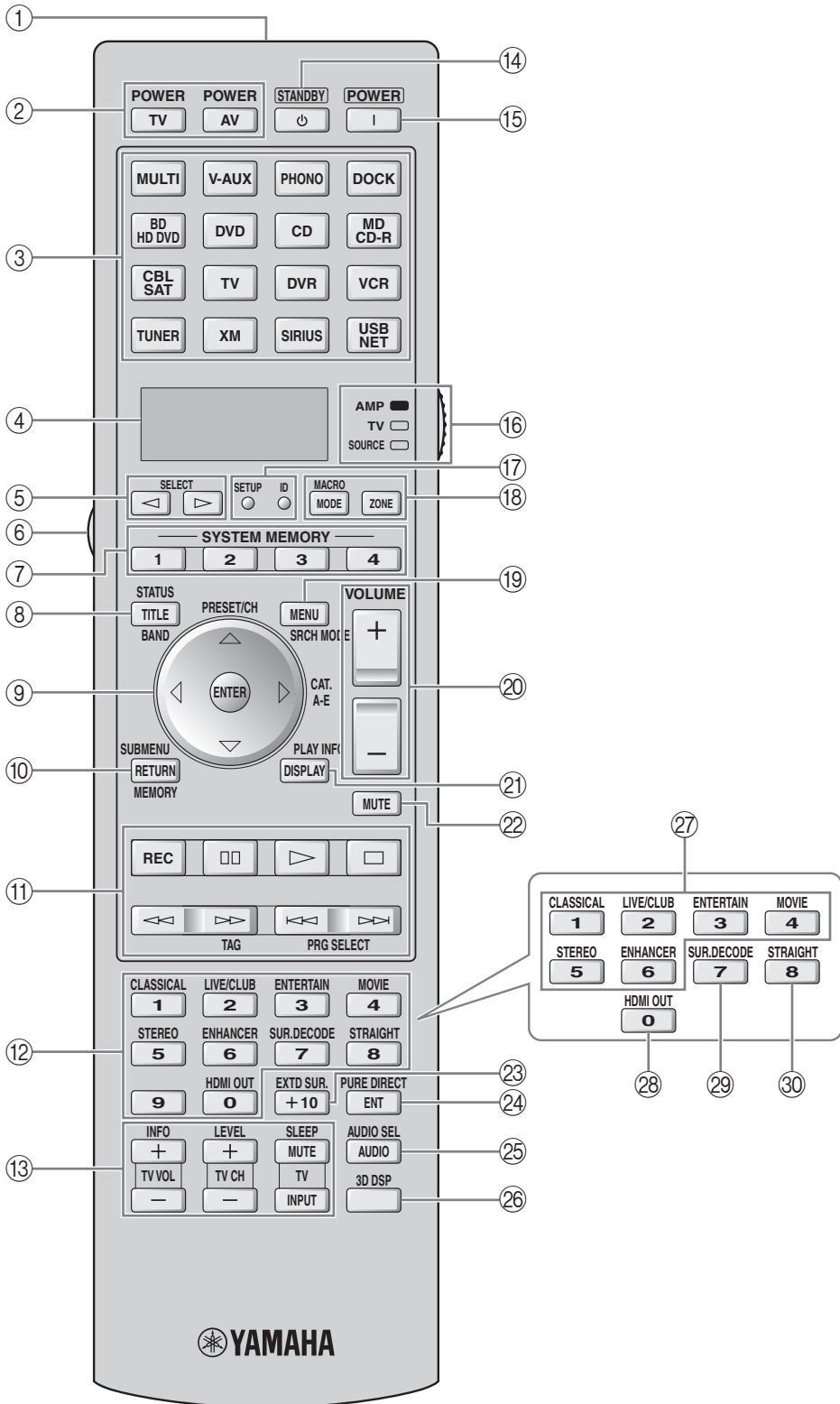

Sound output in each sound field program

- L Front left speaker
- C Center speaker
- R Front right speaker
- SL Surround left speaker
- SR Surround right speaker
- SBL Surround back left speaker
- SBR Surround back right speaker
- PL Presence left speaker
- PR Presence right speaker
- Speaker from which sound is being output
- Speaker from which no sound is being output

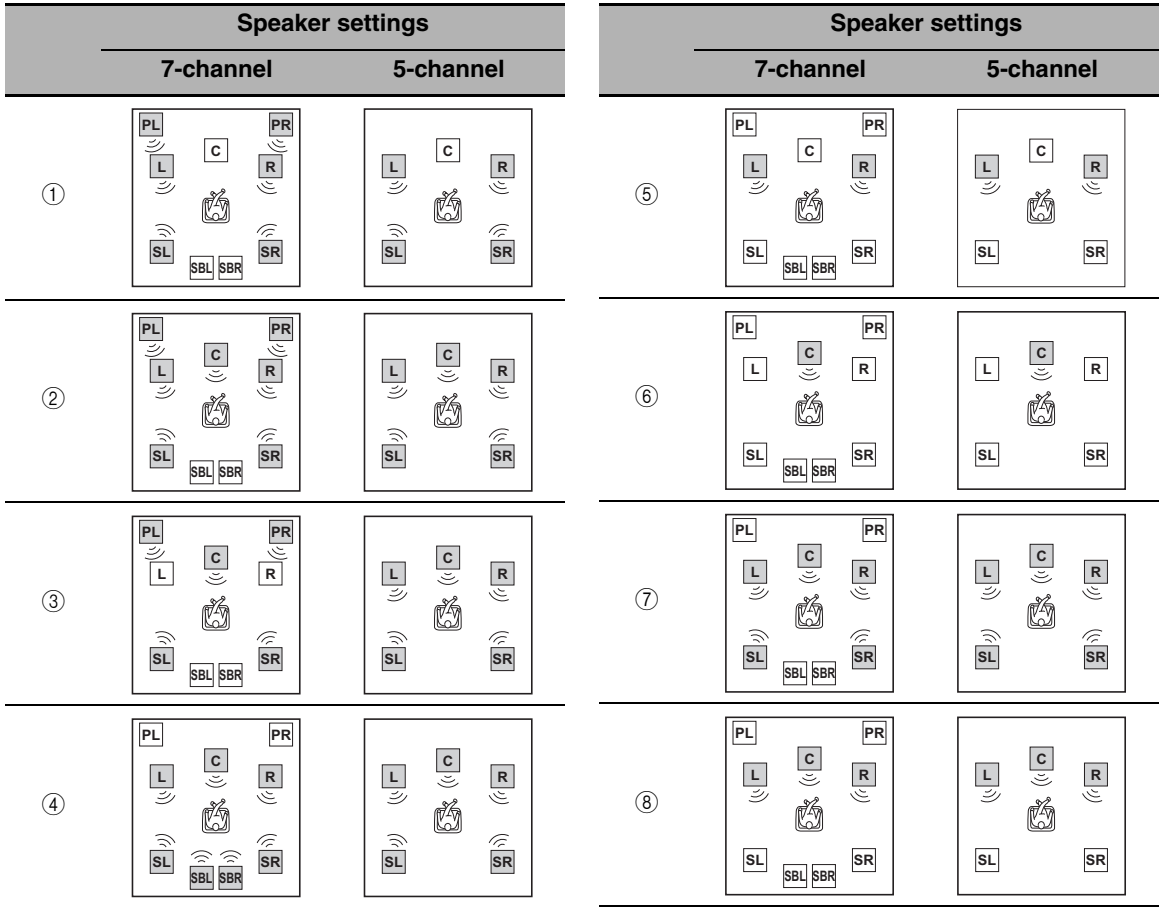

*1 EX / PL IIx / Dolby ES / (neural): OFF

*2 EX / PL IIx / Dolby ES / (neural): ON or discrete 6.1/7.1-channel audio signals are input.

Program	3D	Input audio source			
		2-channel (monaural)	2-channel (stereo)	5.1-channel*1	6.1/7.1-channel*2
CLASSICAL Hall in Munich Hall in Vienna Hall in Amsterdam Church in Freiburg Chamber	ON	①	①	②	②
	OFF				
LIVE/CLUB Village Vanguard Warehouse Loft Cellar Club The Roxy Theatre The Bottom Line		①	①	②	④

Program	3D	Input audio source			
		2-channel (monaural)	2-channel (stereo)	5.1-channel*1	6.1/7.1-channel*2
ENTERTAINMENT Sports	ON	②	②	②	②
Action Game	OFF				
Roleplaying Game					
Music Video					
Recital/Opera					
MOVIE					
Standard		⑦	④	②	④
Spectacle					
Sci-Fi					
Adventure					
Drama					
MOVIE	ON	②	②	②	②
Mono Movie	OFF	③	②	②	④
STEREO 2ch Stereo	--	⑤	⑤	⑤	⑤
STEREO 7ch Stereo	--	④	④	④	④
MUSIC ENHANCER 7ch Enhancer					
SUR.DECODE Surround Decoder (Pro Logic) (PLII Movie) (PLII Game)	--	⑥	⑦	⑦	④
SUR.DECODE Surround Decoder (PLII Music)	--	⑧	⑦	⑦	④
SUR.DECODE Surround Decoder (PLIIX Movie) (PLIIX Game) (Neo:6 Cinema) (CSII Cinema) (NRL-THX)	--	⑥	④	⑦	④
SUR.DECODE Surround Decoder (PLIIX Music) (Neo:6 Music) (CSII Music) (NRL-THX Music)	--	⑧	④	⑦	④
STRAIGHT PURE DIRECT MUSIC ENHANCER Straight Enhancer	--	⑤	⑤	⑦	④

List of remote control codes

TV		CENTURION 00401	FINLUX 00401, 01401,	IMPERIAL 03301, 04701,
ACURA 00101		CGE 03301	01501, 04401,	05201
ADDISON 01201, 01601,		CHANGHONG 09701	06801	INDIANA 00401
08401		CHING TAI 00101, 01201	FIRSTAR 00101, 03101	INFINITY 00801
ADMIRAL 01301, 02201,		CHUN YUN 00001, 00101,	FIRSTLINE 00101, 03301,	INGELEN 02201
05801		01201, 02701	08501	INNO HIT 06801
ADVENT 09601		CHUNG HSIN 00701, 01601,	FISHER 01401, 02001,	INNOVA 00401
AGB 06801		02701	02901, 04701	INTEQ 00201
AIKO 01201		CIMLINE 00101	FLINT 05701	INTERFUNK 00401, 02201,
AKAI 00101, 00301,		CINERAL 01201, 05601	FORMENTI 00401, 04101	03301, 04601,
02901, 04601,		CITIZEN 00301, 00901,	FORTRESS 01301	06701
06801, 08901,		01201	FRONTECH 02201, 03301,	INTERVISION 00401, 03701,
10501		CLARION 02701	03701	05001
AKURA 03701		CLARIVOX 00401	FUJITSU 08701, 10401	ITS 04801
ALBA 00101, 00401,		CLATRONIC 03301, 04701	FUNAI 02501, 02701,	ITT 02201, 04601,
04801, 08501		CONDOR 04101, 04701	03701	06901
AMERICA ACTION		CONRAC 10301	FUTURETECH 02701	JBL 00801
02701		CONTEC 00101, 02701	GATEWAY 13301, 13401	JCB 00001
AMPRO 09401		CRAIG 02701	GE 00301, 00501,	JEAN 00101, 00601,
AMSTRAD 00101, 00401,		CROSLEY 00801	00601, 01201,	01201, 02101,
02501, 04801,		CROWN 00101, 00401,	02601, 02701,	03101
05101, 05301,		02701, 04701,	05601, 07101,	JENSEN 09601
06801		05201	11801, 12201,	JVC 00701, 04801,
ANAM 00101, 02701,		CTC 03301	12601	05801, 08401,
03401		CURTIS MATHES	00401, 06801	08701
ANAM NATIONAL		00301, 00501,	GELOSO 00101	KAISUI 00101
03401, 08301		00801, 00901,	GENEXXA 02201	KAPSCH 02201
ANITECH 00101		01301, 01801,	GIBRALTER 00201, 00301	KARCHER 07701
AOC 00101, 00301,		02001, 02301,	GOLDSTAR 00301, 00401,	KATHREIN 07001
00901, 01201,		05601, 08901,	01701, 02001,	KEC 02701
01301, 01601,		11801, 12201	02601, 05001	KENDO 00401
02601, 02701,		CXC 02701	GOODMANS 00401, 04801,	KENWOOD 00301
05601		DAEWOO 00101, 00301,	04901, 08201	KNEISSEL 03501, 05401
APEX DIGITAL 09301, 09701,		00401, 01201,	GOREMJE 04701	KOLIN 00701, 01601,
09901		01601, 02001,	GRADIENTE 00701, 02401	02701
ASA 01401		02401, 02601,	GRAETZ 02201, 04601	KORPEL 00401
AUDIOSONIC 00401, 01701		02701, 04901,	GRANADA 00401, 02901,	KOYODA 00101
AWA 00101		05601, 07901,	04301, 06801	KTV 00301, 02701
BANG & OLUFSEN		08201, 13101	GRANDIN 07701	L&S ELECTRONIC
07201		DANSAI 00401	GRUNDIG 00401, 02801,	10301
BASIC 00101		DAYTON 00101	06301, 07001,	LEYCO 00401, 03701
BAUR 00401, 04601,		DE GRAAF 02901, 06901	07401	LG 00301, 00401,
06701		DECCA 00401, 06801	GRUNPY 02701	00901, 01601,
BAYSONIC 02701		DENON 01801	HALLMARK 02601	02601, 09001
BEAUMARK 02601		DIGATRON 00401	HANKOOK 00301, 02601,	LIESENK & TTER
BEKO 04701, 06201,		DIXI 00101, 00401	02701	00401
09001, 09101		DUMONT 00201	HANSEATIC 00401, 04101,	LOEWE 06701
BELL & HOWELL		DWIN 09201, 10101	04601, 05201,	LUXOR 04501, 04601
02001		ECE 00401	07001	LXI 00501, 00801,
BEON 00401		ELBE 03501	HANTAREX 06801	02001, 02101,
BLAUPUNKT 02801		ELECTROBAND	HARMAN/KARDON	02601
BLUE SKY 08501, 11401		00001	00801	M ELECTRONIC
BONDSTEC 03301		ELIN 00401, 06901	HARVARD 02701	00101, 00401,
BRADFORD 02701		ELITE 04101	HAVERMY 01301	01401, 01501,
BRANDT 01701, 04201		ELTA 00101	HCM 00101, 05101	01701, 02201,
BROKSONIC 03101, 05801		EMERSON 02001, 02601,	HELLO KITTY 05601	03801, 04401,
BUSH 00101, 00101,		02701, 03101,	HINARI 00101, 00401	04901, 06001
00401, 04801,		04601, 05801,	HISAWA 05701	MAGNADYNE 03301, 06801
04901, 08501,		07901	HITACHI 00101, 00301,	MAGNAFON 06801
11401		ENVISION 00301, 10601	01201, 01501,	MAGNAVOX 00301, 00801,
BYDESIGN 14301, 14401,		EPSON 11001	01701, 01801,	12001, 12601
14501, 14601		ERRES 00401	02201, 02601,	MANESTH 03701, 04101
CANDLE 00301		ETHER 00101, 00301	03001, 04501,	MARANTZ 00301, 00401,
CARNIVALE 00301		ETRON 00101	06101, 06901,	00801, 07001
CARVER 00801, 02401		EUROPHON 06801	07301, 11701,	MARK 00401
CASCADE 00101		FERGUSON 00401, 01001,	12101	MATSUI 00101, 00401,
CATHAY 00401		01701, 03201,	HUA TUN 00101	02901, 04801,
CCE 00401		03801, 04201,	HUANYU 04901	06301, 06801
CELEBRITY 00001		07101	HYPSON 00401, 03701	MATSUSHITA 03401, 08301
CELERA 09701		FIDELITY 04601	ICE 03701, 04801	MEDIATOR 00401
		FINLANDIA 02901, 04401		

MEDION	08501, 10301, 11401	PENNEY	00301, 00501, 00601, 00901, 02101, 02601, 12201	SAMPO	00101, 00301, 01201, 01301, 02001, 02501, 02601, 08301, 13301	TACICO	00101, 01201, 02601
MEGATRON	01801, 02601					TAI YI	00101
MEMOREX	00101, 01901, 02001, 02601, 03401, 05801, 11401	PERDIO	04101			TANDY	01301, 02201
METZ	05501	PHILCO	00301, 00401, 00801, 01801, 02601, 02701, 03301, 05801, 13101	SAMSUNG	00101, 00301, 00401, 00901, 01101, 01201, 02001, 02601, 03701, 04701, 07001, 07401, 07801, 08901, 09801, 10501, 10701	TASHIKO	01201, 08301
MGA	00301, 01901, 02601					TATUNG	00101, 00401, 00601, 00801, 00901, 02001, 02101, 06801
MICROMAXX	10301	PHILIPS	00001, 00301, 00401, 00601, 00801, 01201, 01601, 02601, 04901, 07001, 08801, 12601	SANSEI	05601	TCM	10301
MICROSTAR	10301			SANSUI	05801	TEAC	00101, 00401, 03701, 05101, 05201, 05701, 08501, 11401
MIDLAND	00201, 00501, 00601			SANYO	01401, 02001, 02701, 02901, 04301, 10201	TEC	03301
MINERVA	06301			SBR	00401	TECHNEMA	04101
MINOKA	05101	PHONOLA	00401	SCHAUB LORENZ	04601	TECHNICS	00601, 03401, 08301
MITSUBISHI	00301, 01301, 01601, 01901, 02001, 02601, 02701, 03101, 03401, 06701, 11201, 11901	PILOT	00301	SCHNEIDER	00401, 03301, 04801, 08501	TECHWOOD	00601
MIVAR	03901, 04001, 06801, 07601	PIONEER	01701, 02201, 02301, 03801, 08601, 09501, 11301	SCOTCH	02601	TECO	00101, 00601, 01201, 01301, 02601, 03701, 08401
MOTOROLA	01301	PORTLAND	01201	SCOTT	02601, 02701, 03101	TEKNIKA	00801, 00901, 01201, 01901, 02701
MTC	00301, 00901, 06701	PRANDONI-PRINCE	06801	SEARS	00501, 00801, 02001, 02101, 02501, 02601	TELEFUNKEN	01701, 03601, 04201, 08001, 08901
MULTITECH	00101, 02701	PRIMA	09601	SEG	03701, 08501	TELEMEISTER	04101
MYRYAD	07001	PRISM	00601	SEI	06801	TELETECH	00101
NAD	02101, 02601, 04601, 11301	PROFEX	00101, 04601	SELECO	02201, 03501	TENSAI	04101
NEC	00101, 00301, 00601, 02001, 02101, 02401, 02601, 05701, 06501, 13201	PROSCAN	00501	SEMIVOX	02701	TERA	00301
		PROTECH	00101, 00401, 03301, 03701, 05201, 08501	SEMP	02101	THOMSON	01701, 03801, 07101, 08001, 12501
NECKERMANN	00401, 07001	PROTON	00101, 00301, 02601	SHARP	00301, 01301, 08301	THORN	00401, 01401, 04601, 06701
NEI	00401	PULSAR	00201	SHEN YING	00101, 01201	TMK	02601
NETSAT	00401	QUASAR	00601, 03401, 08301	SHENG CHIA	00101, 01301, 03101	TNCI	00201
NEWAVE	00101, 01201, 01301, 02601	QUELLE	00401, 01401, 04601, 06701	SIAREM	06801	TOSHIBA	00901, 02001, 02101, 06601, 07801, 08301, 10901, 12101, 12301, 13001, 13201
NIKKAI	00401, 03701	RADIOLA	00401	SIEMENS	00401, 02801	TRIUMPH	06801
NIKKO	00301, 01201, 02601	RADIOMARELLI	06801	SINUDYNE	06801	TUNTEX	00101, 00301, 01201
NOKIA	04601, 05901, 06001, 06901, 08101	RADIOHACK	00301, 00501, 02001, 02601, 02701	SKANTIC	04501	TVS	05801
NORCENT	09301, 10801	RCA	00001, 00301, 00501, 01101, 01201, 02601, 08601, 11501, 11801, 13901, 12201, 12501, 12601, 12801	SKY	00401	UHER	04101
NORDMENDE	01701, 03801, 07101			SKYGIANT	02701	UNIVERSUM	00401, 01401, 01501, 03701, 04401, 04701, 06401
NTC	01201	REALISTIC	00301, 02001, 02601, 02701	SKYWORTH	00401	VECTOR RESEARCH	00301
OCEANIC	02201, 04601	REDIFFUSION	04601	SOLAVOX	02201	VESTEL	00401
ONWA	02701, 05301	REOC	09001	SONITRON	02901	VICTOR	00701, 03401, 08301, 08401
OPTIMUS	02001, 02301, 03401, 08301	REVOX	00401	SONOKO	00101, 00401	VIDEOSAT	03301
OPTONICA	01301	REX	02201, 03501, 03701	SONOLOR	02201, 02901	VIDIKRON	00801
ORION	00401, 03101, 04101, 05801, 06801	RFT	05201	SONTEC	00401	VIDTECH	02601
OSAKI	03701, 05101	R-LINE	00401	SONY	00001, 08301, 11101, 11601, 12701, 12901	VIEWSONIC	13301
OTTO VERSAND	00401, 04101, 06701, 07001	ROADSTAR	00101, 03701, 05201	SOUNDDESIGN	02601, 02701	VISION	04101
PALLADIUM	04701, 05201	RUNCO	00201, 00301, 06501, 07501	SOUNDWAVE	00401, 05201	VOXSON	02201
PANAMA	03701	SABA	01701, 02201, 03801, 04201	SOWA	00601, 00901, 01201, 02101, 02601	WALTHAM	04501
PANASONIC	00401, 00601, 00801, 02201, 03401, 08301, 12401	SACCS	03201	SQUAREVIEW	02501	WARDS	00301, 00801, 02601, 11301
PATHE CINEMA	03201, 04101	SAGEM	07701	SSS	02701	WATSON	00401, 04101
PAUSA	00101	SAISHO	00101, 03701, 06801	STANDARD	00101	WAYCON	02101
		SALORA	02201, 04601, 06901	STARLITE	02701	WHITE WESTINGHOUSE	00401, 04101, 05801, 07901
		SAMBERS	06801	STERN	02201, 03501		
				SUPREME	00001		
				SYLVANIA	00301, 00801, 02501		
				SYMPHONIC	02501, 02701		
				SYNCO	00001, 00901, 01201, 01301, 02601, 05601		
				SYSLINE	00401		
				T + A	05501		

YAMAHA	00301, 01801, 08301, 10001, 11001, 13501, 13601, 13701, 13801, 14001, 14101, 14201	DE GRAAF	00702	KEC	00402, 02102	OTTO VERSAND	
YAPSHE	03401	DECCA	00002, 01502	KENWOOD	00602, 01302		01502
YOKO	00401, 03701	DENON	00702	KLH	01402	PALLADIUM	00402, 00602, 01402
ZENITH	00201, 01201, 02601, 05801	DUAL	00602	KODAK	00302, 00402	PANASONIC	00302, 01802, 01902, 03102, 03702, 04502
		DUMONT	00002, 01502, 01602	KOLIN	00602, 00802	PATHE MARCONI	
		DYNATECH	00002	KORPEL	01402		00602
		ELCATECH	01402	LENCO	02102	PENNEY	00302, 00402, 00702, 02002, 03702, 04202
		ELECTROHOME		LEYCO	01402	PENTAX	00702
			00402	LG	00402, 00702, 00902, 02902	PERDIO	00002
		ELECTROPHONIC		LLOYD'S	00002	PHILCO	00302
			00402	LOEWE	00402, 01502, 04502	PHILIPS	00302, 01502, 03202, 03902, 04002
VCR		EMEREX	00102	LOGIK	01402, 02002	PHONOLA	01502
ADMIRAL	01102	EMERSON	00002, 00302, 00402, 00802, 00902, 01702,	LUXOR	00802, 01102, 01602	PILOT	00402
ADVENTURA	00002		02002, 02102, 04302, 04402	MXI	00402	PIONEER	00702, 01302, 01502
AIKO	02102	ESC	02002, 02102	M ELECTRONIC			04002
AIWA	00002, 00402, 02202, 02602, 02702	FERGUSON	00602, 02402		00002	POLK AUDIO	01502
AKAI	00602, 02302	FIDELITY	00002	MAGNASONIC	04302	PROFITRONIC	02002
AKIBA	01402	FINLANDIA	01502, 01602	MAGNAVOX	00002, 00302, 00502, 01502	PROLINE	00002
ALBA	01402, 02102, 02302, 02702	FINLUX	00002, 00702, 01502, 01602	MAGNIN	02002	PROSCAN	01202, 03802
AMERICA ACTION		FIRSTLINE	00402, 00802, 00902, 01402	MANESTH	00902, 01402	PROTEC	01402
	02102	FISHER	01002, 01602	MARANTZ	00302, 01502	PULSAR	00502
AMERICAN HIGH		FUJI	00202, 00302	MARTA	00402	PYE	01502
	00302	FUJITSU	00002, 00902	MATSUI	02602, 02702	QUASAR	00302, 03702
AMSTRAD	00002	FUNAI	00002	MATSUSHITA	00302	QUELLE	01502
ANAM	00402, 01902, 02002, 02102, 02902	GARRARD	00002	MEDION	02602	RADIOLA	01502
ANAM NATIONAL		GE	00302, 01202, 02002, 03502, 03702, 03802	MEI	00302	RADIO SHACK	00002
	01902, 04502			MEMOREX	00002, 00302, 00402, 00502, 01002, 01102, 01602, 02002, 02202, 02602, 04202	RADIX	00402
ANITECH	01402	GEC	01502	METZ	00402, 02502, 04502	RANDEX	00402
ASA	00402, 01502	GENERAL	00902			RCA	00302, 00702, 01202, 02002, 03502, 03702, 03802
ASHA	02002	GO VIDEO	02802	METZ	00402, 02502, 04502	REALISTIC	00002, 00302, 00402, 01002, 01102, 01602
ASUKA	00402	GOLDHAND	01402	MOTOROLA	00302, 01102	REOC	02602
AUDIOVOX	00402, 02102	GOLDSTAR	00402, 01802, 02902, 04202	MTC	00002, 02002	REPLAYTV	03002, 03102
BAIRD	00002, 00602, 01602	GOODMANS	00002, 00402, 01402, 02102	MULTITECH	00002, 01402	REX	00602
BASIC LINE	01402, 02102	GRADIENTE	00002	MURPHY	00002	ROADSTAR	00402, 01402, 02002, 02102
BEAUMARK	02002	GRAETZ	00602, 01602, 02002	MYRYAD	01502	RUNCO	00502
BELL & HOWELL		GRANADA	01502, 01602	NAD	01602	SABA	00602, 02402
	01602	GRANDIN	00002, 00402, 01402	NATIONAL	01902	SALORA	00802
BLAUPUNKT	01902	GRUNDIG	01402, 01502, 01902, 02502	NEC	00302, 00402, 00602, 01102, 01302, 01602	SAMPO	00402, 01102
BRANDT	02402	HANSEATIC	00402	NECKERMANN		SAMSUNG	00902, 02002, 02802
BRANDT ELECTRONIC		HARLEY DAVIDSON	00002		01502	SANKY	00502, 01102
	00602	HARMAN/KARDON	01502	NETSCO	01402	SANSUI	00002, 00602, 01302, 04402
BROKSONIC	01702, 02602, 04402	HARWOOD	01402	NEWAVE	00402	SANYO	01002, 01602, 02002
BUSH	01402, 02102, 02702	HCM	01402	NIKKO	00402	SAVILLE	02702
CALIX	00402	HINARI	01402, 02002, 02702	NOBLEX	02002	SBR	01502
CANON	00302	HI-Q	01002	NOKIA	00602, 01602, 02002	SCHAUB LORENZ	
CARVER	01502	HITACHI	00002, 00402, 00602, 00702, 02002				00002, 00602, 01602
CCE	01402, 02102	HUGHES NETWORK SYSTEMS		NORDMENDE	00602, 02402	SCHNEIDER	00002, 01402, 01502
CGE	00002		00702	OCEANIC	00002, 00602	SCOTT	00802, 00902, 01702
CIMLINE	01402	HYPSON	01402	OKANO	02302, 02602	SEARS	00002, 00302, 00402, 00702, 01002, 01602, 04202
CINERAL	02102	IMPERIAL	00002	OLYMPUS	00302, 01902	SEG	02002
CITIZEN	00402, 02102, 04302	INTERFUNK	01502	OPTIMUS	00402, 01102, 01602, 02802	SEI	01502
COLT	01402	ITT	00602, 01602, 02002	ORION	01702, 02602, 02702, 04402	SELECO	00602
COMBITECH	02702	ITV	00402, 02102	OSAKI	00002, 00402, 01402	SEMP	00902
CRAIG	00402, 01002, 01402, 02002	JENSEN	00602				
CROWN	01402, 02102	JVC	00602, 00902, 01302				
CURTIS MATHES		KAISUI	01402				
	00302, 00602, 01202, 03702						
CYBERNEX	02002						
CYRUS	01502						
DAEWOO	00902, 01602, 02102, 03402, 04302						
DANSAI	01402						

SHARP 01102, 03502
 SHINTOM 01402, 01602
 SIEMENS 00402, 01502, 01602
 SILVA 00402
 SINGER 00902, 01402
 SINUDYNE 01502
 SONIC BLUE 03002, 03102
 SONTEC 00402
 SONY 00002, 00102, 00202, 00302, 03302, 04102
 STS 00702
 SUNKAI 02602
 SUNSTAR 00002
 SUNTRONIC 00002
 SYLVANIA 00002, 00302, 00802, 01502
 SYMPHONIC 00002
 TANDY 00002, 01602
 TASHIKO 00002, 00402
 TATUNG 00002, 00602, 00902, 01302, 01502
 TEAC 00002, 00602, 02102, 02202, 03402
 TECHNICS 00302, 01902
 TECO 00302, 00402, 00602, 01102
 TEKNIKA 00002, 00302, 00402
 TELEAVIA 00602
 TELEFUNKEN 00602, 02402
 TENOSAL 01402
 TENSAI 00002
 THOMAS 00002
 THOMSON 00602, 01202, 01302, 02402
 THORN 00602, 01602
 TIVO 03202, 03302
 TMK 02002
 TOSHIBA 00602, 00802, 00902, 01302, 01502, 03602
 TOTEVISION 00402, 02002
 UHER 02002
 UNITECH 02002
 UNIVERSUM 00002, 00402, 01502, 02002
 VECTOR 00902
 VICTOR 00602, 01302
 VIDEO CONCEPTS 00902
 VIDEOMAGIC 00402
 VIDEOSONIC 02002
 VILLAIN 00002
 WARDS 00002, 00302, 00702, 01002, 01102, 01202, 01402, 01502, 02002
 WHITE WESTINGHOUSE 01402
 XR-1000 00002, 00302, 01402
 YAMAHA 00602
 YAMISHI 01402
 YOKAN 01402
 YOKO 02002
 ZENITH 00002, 00202, 00502, 04402

CABLE

ABC 00103, 00203
 AMERICAST 02003
 BELL SOUTH 02003
 BIRMINGHAM CABLE COMMUNICATIONS 00803
 BRITISH TELECOM 00103
 DAERYUNG 00203, 01403, 01903
 DIRECTOR 01303
 FILMNET 01203
 GENERAL INSTRUMENT 00103, 00803, 01303, 01703
 GOLDSTAR 00503
 HAMLIN 00303, 00703
 JERROLD 00103, 00803, 01303, 01703
 LG 00503
 MEMOREX 00003
 MNET 01203
 MOTOROLA 00803, 01303, 01703, 02303
 NOOS 01803
 PACE 00603, 02203
 PANASONIC 00003, 00203, 00403
 PARAGON 00003
 PHILIPS 01003, 01103
 PIONEER 00503, 01603, 01903
 PULSAR 00003
 PVP STEREO VISUAL MATRIX 00103
 QUASAR 00003
 RCA 02403, 02503
 REGAL 00703, 00903
 RUNCO 00003
 SAGEM 01803
 SAMSUNG 00003, 00503
 SCIENTIFIC ATLANTA 00203, 01403, 01903
 SONY 02103
 STARCOM 00103
 SUPERCABLE 00803
 TELE+1 01203
 TORX 00103
 TOSHIBA 00003
 TRANS PX 00803
 TS 00103
 UNITED CABLE 00103
 ZENITH 00003, 01503, 02003

SATELLITE TUNER

@SAT 06404
 ABSAT 00104
 ALBA 01404
 ALPHASTAR 02504
 AMSTRAD 03004
 ASTON 00304, 05004
 ASTRO 00604
 ATSAT 06404
 AVALON 01304
 BLAUPUNKT 00604
 BRITISH SKY BROADCASTING 03004, 05204
 CANAL DIGITAL 03104

CANAL SATELLITE

03104
 CANAL+ 03104
 CHAPARRAL 00804
 CITYCOM 05304
 CONNEXIONS 01304
 CROSSDIGITAL 04604
 CYRUS 00704
 DAERYUNG 01304
 DAEWOO 06304
 D-BOX 02104, 04904
 DIGENIUS 01104
 DIRECTV 00904, 01204, 01504, 01704, 02204, 02304, 02804, 04104, 04604, 05104, 06904
 DISH NETWORK SYSTEM 02604, 03704
 DISHPRO 02604, 03704
 DISTRATEL 00004
 DMT 04004
 DNT 00704, 01304
 DREAM MULTIMEDIA 05804
 ECHOSTAR 00504, 01304, 01604, 02604, 03104, 03604, 03704, 04304
 ENGEL 03804
 EXPRESSVU 02604
 FINLUX 01404
 FOXTEL 07004, 07104, 07204, 07304, 07404
 FRACARRO 03604
 FTE 03404
 FUBA 01304
 GALAXIS 03404, 04704
 GE 01504
 GENERAL INSTRUMENT 03504
 GOI 02604
 GOLD BOX 03104
 GRUNDIG 00604, 03004
 HIRSCHMANN 00604, 01304
 HITACHI 01404, 02804
 HTS 02604
 HUGHES NETWORK SYSTEM 02304, 05104, 06904
 HUMAX 03404, 05304
 INVIDEO 03604
 JVC 02604
 KATHREIN 00104, 00604, 00704, 01004, 01804, 05604
 KREISELMEYER 00604
 LABGEAR 06304
 LOGIX 03804
 LORENZEN 01104
 MAGNAVOX 02004, 02204
 MANHATTAN 01404, 03804, 04204
 MARANTZ 00704
 MEDIASAT 03104
 MEMOREX 02204
 METRONIC 00004
 MITSUBISHI 02304
 MOTOROLA 03504
 MYRYAD 00704
 NEXT LEVEL 03504

NOKIA 01404, 02104, 02404, 04904, 05704, 06804
 OCTALTV 03704
 ORBITECH 04504
 PACE 01404, 03004, 05204, 06604
 PANASONIC 00904, 01904, 03004, 06504
 PANDA 01404
 PAYSAT 02204
 PHILIPS 00204, 00704, 01404, 02004, 02204, 02304, 03104, 04104, 05104, 06904
 PIONEER 03104
 PROMAX 01404
 PROSCAN 01204, 01504
 RADIOLA 00704
 RADIOSHACK 03504
 RADIX 01304
 RCA 00404, 01204, 01504, 03204
 RFT 00704
 SABRE 01404
 SAGEM 02904, 04804, 05904
 SAMSUNG 03804, 04604, 06004, 06204
 SAT CONTROL 06404
 SATSTATION 04204
 SCHWAIGER 04704
 SEEMANN 01304
 SIEMENS 00604
 SKY 03004, 03304, 05204
 SM ELECTRONIC 05404
 SONY 01704, 03004, 06704
 STAR CHOICE 03504
 STRONG 06404
 TANTEC 01404
 TECHNISAT 04404, 04504
 TELESTAR 04504
 THOMSON 01404, 03104, 03904, 06104
 TOPFIELD 05504
 TOSHIBA 02304, 02704, 06904
 TPS 02904, 05904
 ULTIMATETV 01204, 01704
 UNIDEN 02004, 02204
 UNIVERSUM 00604
 VENTANA 00704
 WISI 00604, 01304, 01404
 XSAT 00104
 ZEHNDR 04004
 ZENITH 03304

CD PLAYER

AIWA 00605
 ARCAM 00605
 AUDIO RESEARCH 00605
 AUDIO TON 00605
 AUDIOLAB 00605
 AUDIOMECA 00605
 CAIRN 00605
 CALIFORNIA AUDIO LABS 00205
 CARVER 00605, 00805

CYRUS 00605
DENON 01005
DKK 00005
DMX ELECTRONICS 00605
DYNAMIC BASS 00805
EMERSON 00905
FISHER 00805
GENEXXA 00305, 00905
GOODMANS 00905
GRUNDIG 00605
HARMAN/KARDON 00605, 00705
HITACHI 00305
JVC 00505
KENWOOD 00105, 00405
KRELL 00605
LINN 00605
LXI 00905
MAGNAVOX 00605, 00905
MARANTZ 00205, 00605
MATSUI 00605
MCS 00205
MEMOREX 00905
MERIDIAN 00605
MICROMEGA 00605
MIRO 00005
MISSION 00605
MYRYAD 00605
NAD 00005
NAIM 00605
NSM 00605
OPTIMUS 00005, 00305, 00405, 00805, 00905
PANASONIC 00205
PHILIPS 00605
PIONEER 00305, 00905
POLK AUDIO 00605
PROTON 00605
QED 00605
QUAD 00605
QUASAR 00205
RCA 00305, 00805, 00905
REALISTIC 00805
REVOX 00605
ROTEL 00605
SAE 00605
SANSUI 00605, 00905
SANYO 00805
SCOTT 00905
SEARS 00905
SHARP 00405
SIMAUDIO 00605
SONIC FRONTIERS 00605
SONY 00005
SYMPHONIC 00905
TAG MCLAREN 00605
TANDY 00305
TECHNICS 00205
THORENS 00605
THULE 00605
UNIVERSUM 00605
VICTOR 00505
WARDS 00605
YAMAHA 01105, 01205

CD RECORDER

KENWOOD 01305
MARANTZ 01305

PHILIPS 01305
YAMAHA 01405

BLU-RAY/DVD PLAYER

ACOUSTIC SOLUTIONS 02806
ALBA 02606
AMSTRAD 02306
APEX DIGITAL 02106, 02606, 03006, 03506, 03606, 03706, 04106
BLAUPINKT 02606
BLUE PARADE 01006
BUSH 02306
CENTREX 02106
CLATRONIC 03406
CYBERHOME 02406
DAEWOO 03206, 03306
DANSAI 03206
DECCA 03206
DENON 00006
DIAMOND 03106
DIGITREX 02106
DVD2000 02006
EMERSON 01206
ENTERPRISE 01206
FISHER 02006
GE 00306, 02606
GO VIDEO 02506
GOLDSTAR 02906, 04906
GRADIENTE 01806
GREENHILL 02606
GRUNDIG 00706
HITACHI 01106, 01507, 01906
HITEKER 02106
JVC 00906, 01306
KENWOOD 00006, 00606
KLH 02606
KOSS 01806
LG 02906
LIMIT 03106
MAGNAVOX 00106, 02206
MARANTZ 00706
MEMOREX 03806
MICO 02706
MICROSOFT 00306
MINTEK 02606
MITSUBISHI 00206
MUSTEK 02806
NESA 02606
ONKYO 00106, 04806
ORITRON 01806
PALSONIC 02106
PANASONIC 00006, 00007, 00107, 00207, 01606, 04206, 05006
PHILIPS 00106, 00706, 00807, 01706, 03906, 05206
PIONEER 00406, 00407, 00507, 00607, 01006, 01506, 01606, 05306
POLK AUDIO 00706
PROSCAN 00306
QWESTAR 01806
RCA 00306, 01006, 02606, 04806
ROTEL 01306
SAMSUNG 01106, 04506
SANYO 02006

SHARP 01207, 01307, 01406
SHERWOOD 03206
SHINSONIC 00506
SLIM ART 03306
SM ELECTRONIC 02806
SONY 00506, 00907, 01007, 01107, 04006, 05106
SYLVANIA 02206
TATUNG 03206
TEAC 01006, 02606
TECHNICS 00006
THETA DIGITAL 01006
THOMSON 00306
TOSHIBA 00106, 00307, 04606, 04806, 05406
URBAN CONCEPTS 00106
VICTOR 01407
XBOX 00306
YAMAHA 00006, 00706, 00707, 00806, 04306, 04406, 04706
ZENITH 00106, 01206, 02906
ZEUS 03306

LD PLAYER

CARVER 00108
DENON 00008
MARANTZ 00108
MITSUBISHI 00008
NAD 00008
NAGSMI 00008
OPTIMUS 00008
PHILIPS 00108
PIONEER 00008
SALORA 00108
SONY 00208
TELEFUNKEN 00008
YAMAHA 00308

MD RECORDER

KENWOOD 00109
ONKYO 00309
SHARP 00209
SONY 00009
YAMAHA 00409, 00509, 00609

RECEIVER (TUNER)

ADC 00710
AIWA 00410, 01210, 03610, 03910, 04410
ALCO 03810
ANAM 04310
APEX DIGITAL 01810
AUDIOLAB 01510
AUDIOTRONIC 01510
AUDIOVOX 03810
BOSE 01610
CAMBRIDGE SOUNDWORKS 03310
CAPETRONIC 00710
CARVER 01210, 01510
CENTREX 01810

DENON 03210
FERGUSON 00710
FINE ARTS 01510
GRUNDIG 01510
HARMAN/KARDON 00210, 02610
INTEGRA 00310, 02510
JBL 00210, 02710
JVC 00110, 00710, 03410, 04110
KENWOOD 01010, 03010
KLH 03810, 04010
MAGNAVOX 00710, 01210, 01510, 02110
MARANTZ 00010, 01210, 01510, 02410
MCS 00010
MICROMEGA 01510
MUSICMAGIC 01210
MYRYAD 01510
NAD 00610
NORCENT 03710
ONKYO 00310, 00810, 02510
OPTIMUS 00710, 00910
PANASONIC 00010, 02310, 04210, 04710
PHILIPS 01210, 01510, 01910, 02010, 02110, 02210, 02410
PIONEER 00710, 00910, 03510
POLK AUDIO 02410
PROSCAN 01710
QUASAR 00010
RCA 00710, 00910, 01710, 03810, 04310
SABA 00710
SANSUI 01210
SCHNEIDER 00710
SONY 00410, 01110, 01310, 04510, 04610
STEREOPHONICS 00910
SUNFIRE 03010
TEAC 03810
TECHNICS 00010, 02810, 02910, 04210
TELEFUNKEN 00710
THOMSON 01710
THORENS 01510
UHER 00710
VENTURER 03810
VICTOR 00110
WARDS 00410
YAMAHA 00510, 01410, 03110, 04810, 05510, 05610, 05710, 05810, 05910, 06010
YAMAHA (iPOD) 05310
YAMAHA (NET) 05410
YAMAHA (TUNER ID1) 04910
YAMAHA (TUNER ID2) 05010
YAMAHA (XM ID1) 05110
YAMAHA (XM ID2) 05210

TAPE DECK

AIWA	00111
CARVER	00111
GRUNDIG	00111
HARMAN/KARDON	00111
MAGNAVOX	00111
MARANTZ	00111
MYRYAD	00111
OPTIMUS	00011
PHILIPS	00111
PIONEER	00011
POLK AUDIO	00111
RCA	00011
REVOX	00111
SANSUI	00111
SONY	00211
THORENS	00111
WARDS	00011
YAMAHA	00311, 00411

Information about software

This product uses the following software.

For information (copyright, etc) about each software, read the original sentences stated below.

■ About The Independent JPEG Group's JPEG software

The Independent JPEG Group's JPEG software

README for release 6b of 27-Mar-1998

This distribution contains the sixth public release of the Independent JPEG Group's free JPEG software. You are welcome to redistribute this software and to use it for any purpose, subject to the conditions under LEGAL ISSUES, below.

Serious users of this software (particularly those incorporating it into larger programs) should contact IJG at jpeg-info@uunet.uu.net to be added to our electronic mailing list. Mailing list members are notified of updates and have a chance to participate in technical discussions, etc.

This software is the work of Tom Lane, Philip Gladstone, Jim Boucher, Lee Crocker, Julian Minguillon, Luis Ortiz, George Phillips, Davide Rossi, Guido Vollbeding, Ge' Weijers, and other members of the Independent JPEG Group.

IJG is not affiliated with the official ISO JPEG standards committee.

DOCUMENTATION ROADMAP

This file contains the following sections:

OVERVIEW	General description of JPEG and the IJG software.
LEGAL ISSUES	Copyright, lack of warranty, terms of distribution.
REFERENCES	Where to learn more about JPEG.
ARCHIVE LOCATIONS	Where to find newer versions of this software.
RELATED SOFTWARE	Other stuff you should get.
FILE FORMAT WARS	Software *not* to get.
TO DO	Plans for future IJG releases.

Other documentation files in the distribution are:

User documentation:

install.doc	How to configure and install the IJG software.
usage.doc	Usage instructions for cjpeg, djpeg, jpegtran, rdjpgcom, and wrjpgcom.
*.1	Unix-style man pages for programs (same info as usage.doc).
wizard.doc	Advanced usage instructions for JPEG wizards only.
change.log	Version-to-version change highlights.

Programmer and internal documentation:

libjpeg.doc	How to use the JPEG library in your own programs.
example.c	Sample code for calling the JPEG library.
structure.doc	Overview of the JPEG library's internal structure.
filelist.doc	Road map of IJG files.
coderrules.doc	Coding style rules --- please read if you contribute code.

Please read at least the files install.doc and usage.doc. Useful information can also be found in the JPEG FAQ (Frequently Asked Questions) article. See ARCHIVE LOCATIONS below to find out where to obtain the FAQ article.

If you want to understand how the JPEG code works, we suggest reading one or more of the REFERENCES, then looking at the documentation files (in roughly the order listed) before diving into the code.

OVERVIEW

This package contains C software to implement JPEG image compression and decompression. JPEG (pronounced "jay-peg") is a standardized compression method for full-color and gray-scale images. JPEG is intended for compressing "real-world" scenes; line drawings, cartoons and other non-realistic images are not its strong suit. JPEG is lossy, meaning that the output image is not exactly identical to the input image. Hence you must not use JPEG if you have to have identical output bits. However, on typical photographic images, very good compression levels can be obtained with no visible change, and remarkably high compression levels are possible if you can tolerate a low-quality image. For more details, see the references, or just experiment with various compression settings.

This software implements JPEG baseline, extended-sequential, and progressive compression processes. Provision is made for supporting all variants of these processes, although some uncommon parameter settings aren't implemented yet. For legal reasons, we are not distributing code for the arithmetic-coding variants of JPEG; see LEGAL ISSUES. We have made no provision for supporting the hierarchical or lossless processes defined in the standard.

We provide a set of library routines for reading and writing JPEG image files, plus two sample applications "cjpeg" and "djpeg", which use the library to perform conversion between JPEG and some other popular image file formats. The library is intended to be reused in other applications.

In order to support file conversion and viewing software, we have included considerable functionality beyond the bare JPEG coding/decoding capability; for example, the color quantization modules are not strictly part of JPEG decoding, but they are essential for output to colormapped file formats or colormapped displays. These extra functions can be compiled out of the library if not required for a particular application. We have also included "jpegtran", a utility for lossless transcoding between different JPEG processes, and "rdjpgcom" and "wrjpgcom", two simple applications for inserting and extracting textual comments in JFIF files.

The emphasis in designing this software has been on achieving portability and flexibility, while also making it fast enough to be useful. In particular, the software is not intended to be read as a tutorial on JPEG. (See the REFERENCES section for introductory material.) Rather, it is intended to be reliable, portable, industrial-strength code. We do not claim to have achieved that goal in every aspect of the software, but we strive for it.

We welcome the use of this software as a component of commercial products. No royalty is required, but we do ask for an acknowledgement in product documentation, as described under LEGAL ISSUES.

LEGAL ISSUES

In plain English:

1. We don't promise that this software works. (But if you find any bugs, please let us know!)
2. You can use this software for whatever you want. You don't have to pay us.
3. You may not pretend that you wrote this software. If you use it in a program, you must acknowledge somewhere in your documentation that you've used the IJG code.

In legalese:

The authors make NO WARRANTY or representation, either express or implied, with respect to this software, its quality, accuracy, merchantability, or fitness for a particular purpose. This software is provided "AS IS", and you, its user, assume the entire risk as to its quality and accuracy.

This software is copyright (C) 1991-1998, Thomas G. Lane.
All Rights Reserved except as specified below.

Permission is hereby granted to use, copy, modify, and distribute this software (or portions thereof) for any purpose, without fee, subject to these conditions:

- (1) If any part of the source code for this software is distributed, then this README file must be included, with this copyright and no-warranty notice unaltered; and any additions, deletions, or changes to the original files must be clearly indicated in accompanying documentation.
- (2) If only executable code is distributed, then the accompanying documentation must state that "this software is based in part on the work of the Independent JPEG Group".
- (3) Permission for use of this software is granted only if the user accepts full responsibility for any undesirable consequences; the authors accept NO LIABILITY for damages of any kind.

These conditions apply to any software derived from or based on the IJG code, not just to the unmodified library. If you use our work, you ought to acknowledge us.

Permission is NOT granted for the use of any IJG author's name or company name in advertising or publicity relating to this software or products derived from it. This software may be referred to only as "the Independent JPEG Group's software".

We specifically permit and encourage the use of this software as the basis of commercial products, provided that all warranty or liability claims are assumed by the product vendor.

ansi2knc.c is included in this distribution by permission of L. Peter Deutsch, sole proprietor of its copyright holder, Aladdin Enterprises of Menlo Park, CA.

ansi2knc.c is NOT covered by the above copyright and conditions, but instead by the usual distribution terms of the Free Software Foundation; principally, that you must include source code if you redistribute it. (See the file ansi2knc.c for full details.) However, since ansi2knc.c is not needed as part of any program generated from the IJG code, this does not limit you more than the foregoing paragraphs do.

The Unix configuration script "configure" was produced with GNU Autoconf. It is copyright by the Free Software Foundation but is freely distributable. The same holds for its supporting scripts (config.guess, config.sub, ltconfig, ltmain.sh). Another support script, install-sh, is copyright by M.I.T. but is also freely distributable.

It appears that the arithmetic coding option of the JPEG spec is covered by patents owned by IBM, AT&T, and Mitsubishi. Hence arithmetic coding cannot legally be used without obtaining one or more licenses. For this reason, support for arithmetic coding has been removed from the free JPEG software. (Since arithmetic coding provides only a marginal gain over the unpatented Huffman mode, it is unlikely that very many implementations will support it.) So far as we are aware, there are no patent restrictions on the remaining code.

The IJG distribution formerly included code to read and write GIF files. To avoid entanglement with the Unisys LZW patent, GIF reading support has been removed altogether, and the GIF writer has been simplified to produce "uncompressed GIFs". This technique does not use the LZW algorithm; the resulting GIF files are larger than usual, but are readable by all standard GIF decoders.

We are required to state that

"The Graphics Interchange Format(c) is the Copyright property of CompuServe Incorporated. GIF(sm) is a Service Mark property of CompuServe Incorporated."

REFERENCES

We highly recommend reading one or more of these references before trying to understand the innards of the JPEG software.

The best short technical introduction to the JPEG compression algorithm is Wallace, Gregory K. "The JPEG Still Picture Compression Standard", Communications of the ACM, April 1991 (vol. 34 no. 4), pp. 30-44.

(Adjacent articles in that issue discuss MPEG motion picture compression, applications of JPEG, and related topics.) If you don't have the CACM issue handy, a PostScript file containing a revised version of Wallace's article is available at <ftp://ftp.uu.net/graphics/jpeg/wallace.ps.gz>. The file (actually a preprint for an article that appeared in IEEE Trans. Consumer Electronics) omits the sample images that appeared in CACM, but it includes corrections and some added material. Note: the Wallace article is copyright ACM and IEEE, and it may not be used for commercial purposes.

A somewhat less technical, more leisurely introduction to JPEG can be found in "The Data Compression Book" by Mark Nelson and Jean-loup Gailly, published by M&T Books (New York), 2nd ed. 1996, ISBN 1-55851-434-1. This book provides good explanations and example C code for a multitude of compression methods including JPEG. It is an excellent source if you are comfortable reading C code but don't know much about data compression in general. The book's JPEG sample code is far from industrial-strength, but when you are ready to look at a full implementation, you've got one here...

The best full description of JPEG is the textbook "JPEG Still Image Data Compression Standard" by William B. Pennebaker and Joan L. Mitchell, published by Van Nostrand Reinhold, 1993, ISBN 0-442-01272-1. Price US\$59.95, 638 pp.

The book includes the complete text of the ISO JPEG standards (DIS 10918-1 and draft DIS 10918-2). This is by far the most complete exposition of JPEG in existence, and we highly recommend it.

The JPEG standard itself is not available electronically; you must order a paper copy through ISO or ITU. (Unless you feel a need to own a certified official copy, we recommend buying the Pennebaker and Mitchell book instead; it's much cheaper and includes a great deal of useful explanatory material.)

In the USA, copies of the standard may be ordered from ANSI Sales at (212)642-4900, or from Global Engineering Documents at (800) 854-7179. (ANSI doesn't take credit card orders, but Global does.) It's not cheap: as of 1992, ANSI was charging \$95 for Part 1 and \$47 for Part 2, plus 7% shipping/handling. The standard is divided into two parts, Part 1 being the actual specification, while Part 2 covers compliance testing methods. Part 1 is titled "Digital Compression and Coding of Continuous-tone Still Images, Part 1: Requirements and guidelines" and has document numbers ISO/IEC IS 10918-1, ITU-T T.81. Part 2 is titled "Digital Compression and Coding of Continuous-tone Still Images, Part 2: Compliance testing" and has document numbers ISO/IEC IS 10918-2, ITU-T T.83.

Some extensions to the original JPEG standard are defined in JPEG Part 3, a newer ISO standard numbered ISO/IEC IS 10918-3 and ITU-T T.84. IJG currently does not support any Part 3 extensions.

The JPEG standard does not specify all details of an interchangeable file format. For the omitted details we follow the "JFIF" conventions, revision 1.02. A copy of the JFIF spec is available from:

Literature Department
C-Cube Microsystems, Inc.
1778 McCarthy Blvd.
Milpitas, CA 95035
phone (408) 944-6300, fax (408) 944-6314

A PostScript version of this document is available by FTP at <ftp://ftp.uu.net/graphics/jpeg/jfif.ps.gz>. There is also a plain text version at <ftp://ftp.uu.net/graphics/jpeg/jfif.txt.gz>, but it is missing the figures.

The TIFF 6.0 file format specification can be obtained by FTP from <ftp://ftp.sgi.com/graphics/tiff/TIFF6.ps.gz>. The JPEG incorporation scheme found in the TIFF 6.0 spec of 3-June-92 has a number of serious problems. IJG does not recommend use of the TIFF 6.0 design (TIFF Compression tag 6). Instead, we recommend the JPEG design proposed by TIFF Technical Note #2 (Compression tag 7). Copies of this Note can be obtained from <ftp.sgi.com> or from <ftp://ftp.uu.net/graphics/jpeg/>. It is expected that the next revision of the TIFF spec will replace the 6.0 JPEG design with the Note's design. Although IJG's own code does not support TIFF/JPEG, the free libtiff library uses our library to implement TIFF/JPEG per the Note. libtiff is available from <ftp://ftp.sgi.com/graphics/tiff/>.

ARCHIVE LOCATIONS

The "official" archive site for this software is <ftp.uu.net> (Internet address 192.48.96.9). The most recent released version can always be found there in directory <graphics/jpeg>. This particular version will be archived as <ftp://ftp.uu.net/graphics/jpeg/jpegsrc.v6b.tar.gz>. If you don't have direct Internet access, UUNET's archives are also available via UUCP; contact help@uunet.uu.net for information on retrieving files that way.

Numerous Internet sites maintain copies of the UUNET files. However, only <ftp.uu.net> is guaranteed to have the latest official version.

You can also obtain this software in DOS-compatible "zip" archive format from the SimTel archives (<ftp://ftp.simtel.net/pub/simtelnet/msdos/graphics/>), or on CompuServe in the Graphics Support forum (GO CIS:GRAPHSUP), library 12 "JPEG Tools". Again, these versions may sometimes lag behind the <ftp.uu.net> release.

The JPEG FAQ (Frequently Asked Questions) article is a useful source of general information about JPEG. It is updated constantly and therefore is not included in this distribution. The FAQ is posted every two weeks to Usenet newsgroups <comp.graphics.misc>, <news.answers>, and other groups. It is available on the World Wide Web at <http://www.faqs.org/faqs/jpeg-faq/> and other [news.answers](http://www.answers.com) archive sites, including the official [news.answers](http://rtfm.mit.edu) archive at rtfm.mit.edu: <ftp://rtfm.mit.edu/pub/usenet/news.answers/jpeg-faq/>. If you don't have Web or FTP access, send e-mail to mail-server@rtfm.mit.edu with body

send usenet/news.answers/jpeg-faq/part1
send usenet/news.answers/jpeg-faq/part2

RELATED SOFTWARE

Numerous viewing and image manipulation programs now support JPEG. (Quite a few of them use this library to do so.) The JPEG FAQ described above lists some of the more popular free and shareware viewers, and tells where to obtain them on Internet.

If you are on a Unix machine, we highly recommend Jef Poskanzer's free PBMPPLUS software, which provides many useful operations on PPM-format image files. In particular, it can convert PPM images to and from a wide range of other formats, thus making cjpeg/djpeg considerably more useful. The latest version is distributed by the NetPBM group, and is available from numerous sites, notably ftp://wuarchive.wustl.edu/graphics/graphics/packages/NetPBM/. Unfortunately PBMPPLUS/NETPBM is not nearly as portable as the IJG software is; you are likely to have difficulty making it work on any non-Unix machine.

A different free JPEG implementation, written by the PVRG group at Stanford, is available from ftp://havefun.stanford.edu/pub/jpeg/. This program is designed for research and experimentation rather than production use; it is slower, harder to use, and less portable than the IJG code, but it is easier to read and modify. Also, the PVRG code supports lossless JPEG, which we do not. (On the other hand, it doesn't do progressive JPEG.)

FILE FORMAT WARS

Some JPEG programs produce files that are not compatible with our library. The root of the problem is that the ISO JPEG committee failed to specify a concrete file format. Some vendors "filled in the blanks" on their own, creating proprietary formats that no one else could read. (For example, none of the early commercial JPEG implementations for the Macintosh were able to exchange compressed files.)

The file format we have adopted is called JFIF (see REFERENCES). This format has been agreed to by a number of major commercial JPEG vendors, and it has become the de facto standard. JFIF is a minimal or "low end" representation. We recommend the use of TIFF/JPEG (TIFF revision 6.0 as modified by TIFF Technical Note #2) for "high end" applications that need to record a lot of additional data about an image. TIFF/JPEG is fairly new and not yet widely supported, unfortunately.

The upcoming JPEG Part 3 standard defines a file format called SPIFF. SPIFF is interoperable with JFIF, in the sense that most JFIF decoders should be able to read the most common variant of SPIFF. SPIFF has some technical advantages over JFIF, but its major claim to fame is simply that it is an official standard rather than an informal one. At this point it is unclear whether SPIFF will supersede JFIF or whether JFIF will remain the de-facto standard. IJG intends to support SPIFF once the standard is frozen, but we have not decided whether it should become our default output format or not. (In any case, our decoder will remain capable of reading JFIF indefinitely.)

Various proprietary file formats incorporating JPEG compression also exist. We have little or no sympathy for the existence of these formats. Indeed, one of the original reasons for developing this free software was to help force convergence on common, open format standards for JPEG files. Don't use a proprietary file format!

TO DO

The major thrust for v7 will probably be improvement of visual quality. The current method for scaling the quantization tables is known not to be very good at low Q values. We also intend to investigate block boundary smoothing, "poor man's variable quantization", and other means of improving quality-vs-file-size performance without sacrificing compatibility.

In future versions, we are considering supporting some of the upcoming JPEG Part 3 extensions --- principally, variable quantization and the SPIFF file format. As always, speeding things up is of great interest. Please send bug reports, offers of help, etc. to jpeg-info@uunet.uu.net.

■ About PNG Reference Library

libpng versions 1.2.6, August 15, 2004, through 1.2.29, May 8, 2008, are Copyright (c) 2004, 2006-2008 Glenn Randers-Pehrson, and are distributed according to the same disclaimer and license as libpng-1.2.5 with the following individual added to the list of Contributing Authors

Cosmin Truta

libpng versions 1.0.7, July 1, 2000, through 1.2.5 - October 3, 2002, are Copyright (c) 2000-2002 Glenn Randers-Pehrson, and are distributed according to the same disclaimer and license as libpng-1.0.6 with the following individuals added to the list of Contributing Authors

Simon-Pierre Cadieux
Eric S. Raymond
Gilles Vollant

and with the following additions to the disclaimer:

There is no warranty against interference with your enjoyment of the library or against infringement. There is no warranty that our efforts or the library will fulfill any of your particular purposes or needs. This library is provided with all faults, and the entire risk of satisfactory quality, performance, accuracy, and effort is with the user.

libpng versions 0.97, January 1998, through 1.0.6, March 20, 2000, are Copyright (c) 1998, 1999 Glenn Randers-Pehrson, and are distributed according to the same disclaimer and license as libpng-0.96, with the following individuals added to the list of Contributing Authors:

Tom Lane
Glenn Randers-Pehrson
Willem van Schaik

libpng versions 0.89, June 1996, through 0.96, May 1997, are Copyright (c) 1996, 1997 Andreas Dilger Distributed according to the same disclaimer and license as libpng-0.88, with the following individuals added to the list of Contributing Authors:

John Bowler
Kevin Bracey
Sam Bushell
Magnus Holmgren
Greg Roelofs
Tom Tanner

libpng versions 0.5, May 1995, through 0.88, January 1996, are Copyright (c) 1995, 1996 Guy Eric Schalnat, Group 42, Inc.

For the purposes of this copyright and license, "Contributing Authors" is defined as the following set of individuals:

Andreas Dilger
Dave Martindale
Guy Eric Schalnat
Paul Schmidt
Tim Wegner

The PNG Reference Library is supplied "AS IS". The Contributing Authors and Group 42, Inc. disclaim all warranties, expressed or implied, including, without limitation, the warranties of merchantability and of fitness for any purpose. The Contributing Authors and Group 42, Inc. assume no liability for direct, indirect, incidental, special, exemplary, or consequential damages, which may result from the use of the PNG Reference Library, even if advised of the possibility of such damage.

Permission is hereby granted to use, copy, modify, and distribute this source code, or portions hereof, for any purpose, without fee, subject to the following restrictions:

1. The origin of this source code must not be misrepresented.
2. Altered versions must be plainly marked as such and must not be misrepresented as being the original source.
3. This Copyright notice may not be removed or altered from any source or altered source distribution.

The Contributing Authors and Group 42, Inc. specifically permit, without fee, and encourage the use of this source code as a component to supporting the PNG file format in commercial products. If you use this source code in a product, acknowledgment is not required but would be appreciated.

■ About zlib Library

Copyright notice:
(C) 1995-2004 Jean-loup Gailly and Mark Adler

This software is provided 'as-is', without any express or implied warranty. In no event will the authors be held liable for any damages arising from the use of this software.

Permission is granted to anyone to use this software for any purpose, including commercial applications, and to alter it and redistribute it freely, subject to the following restrictions:

1. The origin of this software must not be misrepresented; you must not claim that you wrote the original software. If you use this software in a product, an acknowledgment in the product documentation would be appreciated but is not required.
2. Altered source versions must be plainly marked as such, and must not be misrepresented as being the original software.
3. This notice may not be removed or altered from any source distribution.

Jean-loup Gailly Mark Adler
jloup@gzip.org madler@alumni.caltech.edu

If you use the zlib library in a product, we would appreciate *not* receiving lengthy legal documents to sign. The sources are provided for free but without warranty of any kind. The library has been entirely written by Jean-loup Gailly and Mark Adler; it does not include third-party code.

If you redistribute modified sources, we would appreciate that you include in the file ChangeLog history information documenting your changes. Please read the FAQ for more information on the distribution of modified source versions.



The circled numbers and alphabets correspond to those in the Owner's Manual.
 Les nombres et lettres dans un cercle correspondent à ceux du mode d'emploi.

■ Front panel / Face avant

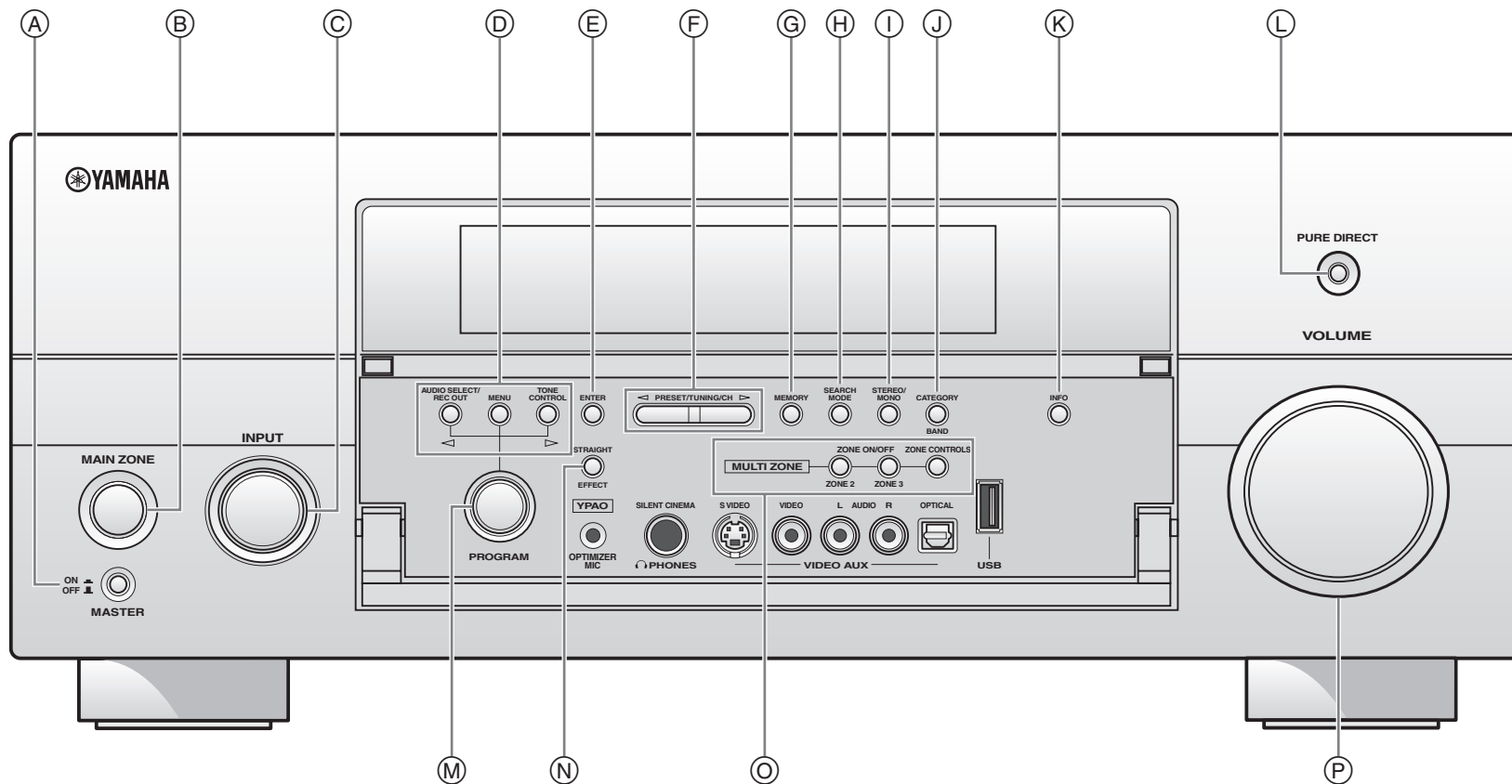

■ Remote control / Boîtier de télécommande

