



---

# PM1D System Software V1.5

---

## **Supplementary Manual**



**Copyright**

Copying or distributing this manual in part or in whole using any method without the written permission of Yamaha Corporation is prohibited.

**Trademarks**

Company names and product names are trademarks and registered trademarks of their respective owners. Symbols such as ® and TM are not explicitly given in this document.

The illustrations and LCD screens as shown in this owner's manual are for instructional purposes only, and may appear somewhat different from those on your instrument.

# Contents

<b>Additions/changes in V1.5</b> . . . . .	4	<b>Auto Store function</b> . . . . .	64
<b>Changes to the constantly-displayed screen</b> . .	6	Using Auto Store from the screen . . . . .	64
Upper part of the display . . . . .	6	Using Auto Store from the [STORE] switch . .	65
Lower part of the display . . . . .	8	<b>Global Paste function</b> . . . . .	66
<b>DUAL CONSOLE mode added</b> . . . . .	11	GLOBAL PASTE screen . . . . .	66
About Dual Console mode . . . . .	11	Using the Global Paste function . . . . .	68
About scene/library memories . . . . .	13	<b>Parameter control via CONTROL CHANGE and</b>	
About the console shutdown function . . . .	14	<b>NRPN</b> . . . . .	71
DUAL CONSOLE screen . . . . .	14	MIDI CTRL CHANGE screen . . . . .	71
Connections in Dual Console mode . . . . .	17	Using CONTROL CHANGE / NRPN messag-	
Establishing communication between con-		es to record/play parameter changes . . . .	74
sols . . . . .	18	<b>Manual Fading function</b> . . . . .	76
Transmitting only the necessary scenes / li-		New functions in the FADE TIME screen . . .	76
braries . . . . .	21	Using Manual Fading (1) . . . . .	76
Limitations of Dual Console mode . . . . .	21	Using Manual Fading (2) . . . . .	78
Powering-off the consoles . . . . .	26	<b>Unit name</b> . . . . .	79
<b>Cascade connections</b> . . . . .	27	UNIT NAME screen . . . . .	79
About cascade connections . . . . .	27	Naming a unit/port . . . . .	81
CASCADE screen . . . . .	27	<b>Matrix send shortcuts</b> . . . . .	82
Cascade connections . . . . .	29	<b>DCA mute indicator</b> . . . . .	85
Establishing a cascade connection . . . . .	31	<b>Oscillator improvements</b> . . . . .	86
Cautions when using cascade connection . .	33	Improvements in the OSCILLATOR screen .	86
<b>Using GPI (General Purpose Interface)</b> . . . .	35	<b>Improvements in the INPUT PATCH / OUT-</b>	
GPI screen . . . . .	36	<b>PUT PATCH screens</b> . . . . .	89
Using GPI IN . . . . .	40	<b>USB PC (computer) connection</b> . . . . .	89
Using GPI OUT . . . . .	41	<b>Automatic scrolling in the CH to MIX screen</b>	
<b>Fader Start function</b> . . . . .	42	<b>and MATRIX/ST ROUTING screen</b> . . . . .	90
FADER START screen . . . . .	43	<b>ON/OFF button for COMM IN</b> . . . . .	91
Using the Fader Start function . . . . .	45	<b>Added functions in the PREFERENCE screen</b> .	92
<b>Tap Tempo function</b> . . . . .	51	<b>Supplementary explanation for existing func-</b>	
<b>Added functions in the USER DEFINE screen</b>	52	<b>tions</b> . . . . .	93
<b>Input channel panel assignments</b> . . . . .	52	<b>Scene Memory/Effect Library to Program</b>	
PANEL ASSIGN screen . . . . .	52	<b>Change Table</b> . . . . .	94
Switching the panel assign setting . . . . .	55	<b>MIDI control change NRPN (Non Registered</b>	
<b>Horizontal pair and vertical pair</b> . . . . .	56	<b>Parameter Number) assignment table</b> . . . .	94
<b>Mix minus</b> . . . . .	58	<b>MIDI control change parameter assignment</b>	
New functions in the PAN/ROUTING screen	58	<b>table</b> . . . . .	97
Using mix minus . . . . .	59	<b>MIDI Data Format</b> . . . . .	100
Cautions regarding mix minus . . . . .	60		
<b>Job select</b> . . . . .	61		
Mix send on/off . . . . .	61		
Mix send point . . . . .	62		
Mix send level . . . . .	62		
Mix send pan/balance . . . . .	63		

This manual explains the functionality that has been added or changed in PM1D system software V1.5. Please refer to the original manual in conjunction with this manual.

\* In cases where the display of the console (CS1D) differs from the screen of the PM1D Manager application program, explanations that apply only to PM1D Manager are indicated as [PM1D Manager].

---

## Additions/changes in V1.5

---

This section briefly summarizes the additions and changes in PM1D system software V1.5. For details on each function, refer to the appropriate page.

### ■ Changes to the constantly-displayed screen

Major changes have been made to the items that are always shown in the top and bottom of the screen (→p.6).

### ■ New DUAL CONSOLE mode

As an operation mode of the PM1D system, a DUAL CONSOLE mode has been added, allowing two consoles to be used with one system (→p.11).

### ■ Cascade connection

Two systems can now be cascade-connected. A cascade-connected system can send any bus output to the same bus of the other system (→p.27).

### ■ GPI connector is now enabled

The D-sub 25 pin GPI connector provided on the console and engine can now be used to input/output eight channels of control signals (→p.35).

### ■ REMOTE connector is now enabled

The D-sub 9-pin REMOTE connector of the console and engine can now be used to control a recorder or other device (→p.35).

### ■ Fader Start function

You can now specify that various commands be transmitted from an assigned connector when the level of a specified channel is raised above  $-60$  dB or lowered to  $-\infty$  dB (→p.42).

### ■ Tap tempo function

A “tap tempo” function has been added, allowing you to manually set the TEMPO parameter of an internal effect by tapping an external switch connected to the GPI connector (→p.51).

### ■ Expanded USER DEFINE functions

In conjunction with the addition of various functionality, the user-definable functions have been significantly expanded (→p.52).

### ■ Input channel panel assignment can now be selected

The input channels assigned to INPUT blocks 1–4 of the console can now be freely specified in blocks of twelve consecutive channels. Similarly, the ST IN channels assigned to ST IN blocks 1–2 can also be assigned in blocks of two adjacent channels (→p.52). Also, the DISPLAY SELECT section of the TRACKING RECALL screen now has an INPUT [PANEL] button that causes the current panel assignment state to be displayed in the screen.

### ■ New pairing mode

In addition to the existing pairing mode in which adjacent input channels 1+2, 3+4, ... can be paired, you can now use “vertical pairing mode” in which input channels 1+49, 2+50 ... are paired. This mode allows you to use a single fader as if it were a stereo fader (→p.56).

### ■ Mix minus setting

A MIX MINUS button has been added to the CH to MIX screen of the PAN/ROUTING function. This button provides a simple way to subtract only a specific channel from the signal that is being sent to a certain MIX bus. This is useful when a performer or announcer wishes to monitor the sound without his own voice (→p.58).

### ■ Job select

Now you can move the cursor to a parameter and press the [SHIFT] + [ENTER] keys to access a popup-menu that lists the jobs available for that parameter. The cursor will turn yellow to indicate parameters for which you can use this function (→p.61).

### ■ Auto Store function

When storing a scene, you can now use an “Auto Store function” that automatically selects the unit, patch, or name library number and title (→p.64).

### ■ Global Paste function

Using the new “Global Paste function,” the settings of any channel or parameter in the current scene can be copied and pasted to one or more scenes in scene memory. This is a convenient way by which changes in the current scene can be applied to previously-stored scenes (→p.66).

## ■ Operate parameters via control changes

Now you can use MIDI control changes to remotely control PM1D parameters from an external device, or transmit console operations as control changes (→p.71).

## ■ Manual fading

A new “Manual Fading” function has been added. When recalling a scene for which a fade time has been set, you can now use the [DATA] encoder to fade in the positive or negative direction. This is convenient when you want to vary the volume in conjunction with action on stage (→p.76).

## ■ Unit name

You can now assign a unit name to each port of an input/output unit or card. If necessary, the unit name of each port can be displayed in the field in which the short name of an input channel was shown in the screen (→p.79).

## ■ Matrix send shortcut

The send level from a MIX channel or STEREO A/B channel to a MATRIX channel can now be controlled from a panel encoder (→p.82).

## ■ DCA mute indicator

When you mute a DCA group, the [ASSIGN DCA] LED of the channels associated with that DCA can now be made to blink if desired. This is convenient when you want to know which channels are actually being muted (→p.85).

## ■ Improved oscillator

The oscillator now lets you use two sine waves simultaneously. You can specify the frequency and level for each, and output them independently to odd-numbered / even-numbered channels (→p.86).

## ■ Improvements in the INPUT PATCH / OUTPUT PATCH screens

The unit name of each port is now displayed in the UNIT PATCH / OUTPUT PATCH screens. Vertical and horizontal red lines can also indicate the currently selected grid (→p.89).

## ■ USB connection to a PC

In addition to the serial connection supported on earlier versions, you can now use a USB connection to connect the PM1D to a PC (→p.89).

## ■ Improved operation in the CH to MIX and MATRIX/ST ROUTING screens

Cursor movement now follows scrolling in the CH to MIX function of the PAN/ROUTING function and in the MATRIX/ST ROUTING screen of the MATRIX/ST function (→p.90).

## ■ ON/OFF button added to COMM IN

The COMM IN function can now be turned ON/OFF independently (→p.91).

## ■ Additional functions in the PREFERENCE screen

A variety of setting items have been added in the PREFERENCE screen (→p.92).

## ■ Channel selection can now be separately specified for the AUTO DISPLAY function (SELECTED CH ON/OFF button)

One of the AUTO DISPLAY functions automatically moves the cursor to the corresponding parameter when you switch the channel that is being operated.

In the PREFERENCE screen AUTO DISPLAY section, this function can now be switched on/off independently of the other AUTO DISPLAY items (→p.92).

## Changes to the constantly-displayed screen

In PM1D system software V1.5, the following changes have been made to the items that are always shown in the top and bottom of the console display.

### Upper part of the display

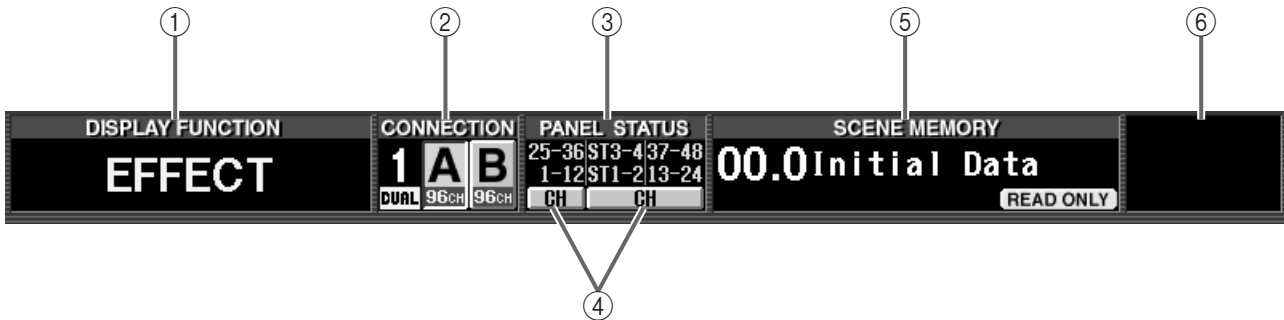

#### ① DISPLAY FUNCTION

Shows the currently selected function as an abbreviation.



Click this to switch between the FUNCTION MENU screen and the screen of the currently selected function. (Equivalent to the MENU button of the previous version.)

#### ② CONNECTION

Indicates the status of the connections between the engine(s) and console(s).

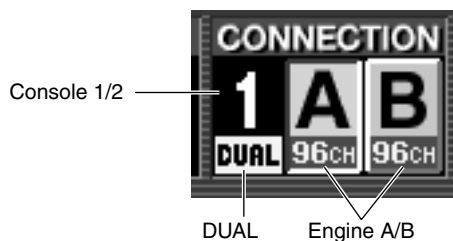

##### • Console 1/2

If DUAL CONSOLE is selected as the console operation mode (SYSTEM CONFIGURATION in the SYSTEM CONNECTION screen, etc.), this indicates whether that console (CS1D) is specified as console 1 or as console 2 (→p.19).

The color of this numeral will depend on how CASCADE is set for the operation mode. In the case of CASCADE OFF or CASCADE ON [MASTER], this numeral will be white on a black background. If CASCADE ON [SLAVE], this numeral will be black on a white background.



If cascade communication between the systems cannot be established even though CASCADE ON is selected, this numeral will blink.

##### • DUAL

If DUAL CONSOLE is selected as the operation mode for the console, “DUAL” will be displayed here (→p.19).



If communication between the consoles cannot be established even though DUAL CONSOLE mode is selected, an X mark will be displayed over the “DUAL” indication.

##### • Engine A/B

If the PM1D system is being used in mirror mode, this indicates which engine (A or B) is currently enabled, and the number of usable channels. The enabled engine is shown on a green background. You can also click this button to switch between engines A/B.



If the engine that should be enabled is not operating normally, or if the connection has been broken, an X mark will be displayed over the A or B symbol.

#### ③ PANEL STATUS

Indicates the current panel assignment (the channel numbers assigned to the INPUT block / ST IN block).

#### ④ FADER FLIP





Indicates the state of the FADER FLIP switch located on the console panel (i.e., whether [MIX] or [CH] is on). You can also use these buttons to switch [MIX] and [CH].



If the FADER FLIP LINK button is turned off in the UTILITY function PANEL ASSIGN screen (a new screen added in V1.5), fader flip can be switched independently for INPUT blocks 1/2 (left) and 3/4 (right) (→p.54).

⑤ SCENE MEMORY



Displays the number and title used when most recently recalling/storing the currently selected scene memory. Depending on the state of the scene, the following symbols may be displayed in the margin of the SCENE MEMORY field.

- **EDIT**  This symbol will be displayed if you edit a parameter of a scene, patch, unit, or name after recalling/storing a scene memory. When you recall/store a scene memory, this symbol will disappear. (However, it may not disappear if Recall Safe is turned on.)
- **TC**  This symbol will be displayed if the EVENT RECALLING button is set to ENABLE in the TC EVENT screen. You cannot rewrite scene memories or patch/unit/name libraries while this symbol is displayed. This means that you will also be unable to use functions such as store, undo store, link on/off, title editing, sort, or load.
- **PREVIEW**  In PREVIEW mode, this symbol will be displayed. In PREVIEW mode, the scene number and title will be displayed in white characters on a red background.
- **READ ONLY**  The READ ONLY symbol will be displayed if the scene currently selected for store/recall is read-only (00.0-00.9). The PROTECT symbol will be displayed if protect is turned on.
- **PROTECT**  The PROTECT symbol will be displayed if protect is turned on.

⑥ Other symbols

The following symbols will be displayed at the upper right of the display according to the state of the console.



- **SOLO/CUE**  According to the current solo or cue state, this area will display the following symbols: SOLO, EFFECT CUE, SUBIN CUE, INPUT CUE, DCA CUE, OUTPUT CUE, KEY IN CUE
- **TB/OSC (Talkback / Oscillator)**   The TB symbol will be displayed if talkback is on, and the OSC symbol will be displayed if the oscillator is on.



If the above operations occur simultaneously, they will be displayed in the order of TB → OSC.

• **COMM IN (Communication In)**



If COMM IN is turned on in the MONITOR A screen, the COMM IN symbol will be displayed on a green background. In addition if a port is assigned to COMM IN, the background of this symbol will change to red when the input signal passes through the COMM IN gate.

• **LCR**  

The LCR symbol will be displayed if LCR is turned on for at least one input channel or output channel (in the LCR screen of the PAN/ROUTING or MATRIX/ST function). In addition if the CENTER BUS CONTROL button (in the LCR screen of the PAN/ROUTING or MATRIX/ST function) is on, the LCR [B] symbol will be displayed.

• **RS422, MIDI, BUSY**

- **RS422** 

This symbol will be displayed when a response to a transport command sent via the RS422 connector is received.

- **MIDI** 

This symbol will be displayed when a program change or control change is received.

- **BUSY** 

This symbol will be displayed during startup or while internal memory or a PC card file is being accessed.



- If the above states occur simultaneously, they will be displayed in descending priority of RS422 → MIDI → BUSY.
- The RS422 and MIDI symbols will remain visible for approximately 200 msec after reception is completed.
- The BUSY symbol will disappear immediately when access is completed.

• **MANUAL FADE, AUTO FADE, TRACKING ENABLE**

- **MANUAL FADE** 

This symbol will be displayed if Manual Fading is enabled (even if a fade operation is not actually being performed) (→p.76).

- **AUTO FADE** 

This symbol will be displayed while Auto Fading is being executed.

- **TRACKING (Tracking Recall)**



This symbol will be displayed if tracking recall is enabled (the TRACKING RECALL button is set to ENABLE in the TRACKING RECALL screen).



If the above states occur simultaneously, they will be displayed in descending priority of MANUAL FADE → AUTO FADE → TRACKING.

**[PM1D Manager]**

In PM1D Manager, the following information will be displayed instead of ③ PANEL STATUS and ④ FADER FLIP described on page 6.

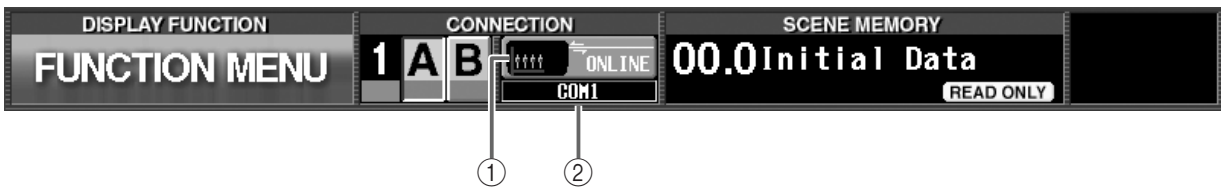

**① Connection status**

This area of the PM1D Manager screen will indicate the status of the connection between the PC and the console or engine.

- .....Indicates that a cable is connected between the PC and console or engine, but communication has not been established.
- .....Indicates that a cable is connected between the PC and console or engine, and that communication has been established. In this state, the PM1D system can be controlled from the computer.

- .....Indicates that either the cable is not connected, or that the other device is not powered-on.

**② Connection destination / connection method**

In OFFLINE or ONLINE states, this area will show a graphic that indicates the connection destination (console or engine), and the connector (COM port name or USB port name) that is selected in the Communication Port (Option menu) of Communication Setup.

**Lower part of the display**

The lower part of the display is divided into the following four parts. Click the ◀/▶ buttons at the lower left of the screen to switch the items that are shown.

**■ CONSOLE STATUS**

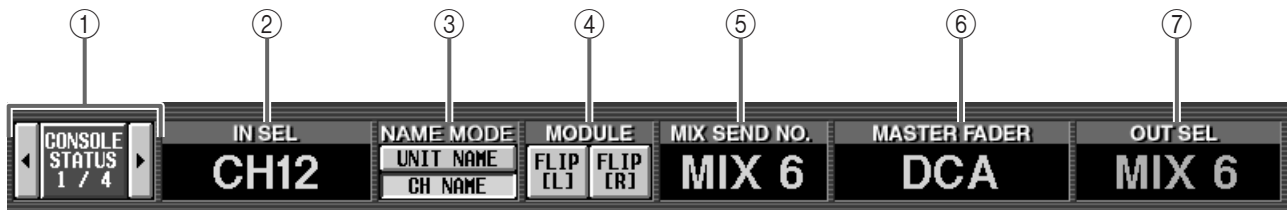

**① Select buttons**

Click the ◀/▶ buttons to switch the items that are displayed.

**② IN SEL (Selected input channel)**

Indicates the input channel that is currently selected by the [SEL] switch.

**③ NAME MODE**

Selects whether the display will show the short name of the input channel (CH NAME), or the name of the unit assigned to that input channel (UNIT NAME) (→p.79).

**④ MODULE FLIP**

Indicates the on/off state of the MODULE [FLIP] switch in the SELECTED INPUT CHANNEL block. You can also click this button to change the module flip setting.



- If the PATTERN CHANGE button is turned on in the MODULE FLIP BUTTON MODE section of the UTILITY function PANEL ASSIGN screen (a new screen added in V1.5), the indications of these buttons will change to “PATT.” In this case, they are used to switch channel assign patterns for the INPUT block (→p.52).
- If the MODULE FLIP / PATTERN CHANGE LINK button in the same screen is turned off, settings for module flip and patterns can be made independently for the left and right INPUT blocks (→p.54).



- ⑤ **MIX SEND NO. (Mix send number)**  
Indicates the number of the MIX bus that is currently selected as the send destination for INPUT blocks 1–4.
- ⑥ **MASTER FADER**  
Indicates the function that is currently assigned to DCA faders 1–12 (DCA GROUP block).
- ⑦ **OUT SEL (Selected output channel)**  
Indicates the output channel that is currently selected by the [SEL] switch.

**[PM1D Manager]**  
In PM1D Manager, the following information will be displayed instead of ④–⑥ described above.



① **DIRECT RECALL / MUTE MASTER**  
According to the setting of the RECALL button or MUTE button, these buttons either directly recall twelve previously-assigned scenes, or switch mute groups 1–12 on/off. These buttons have the same function as SCENE MEMORY [1]–[12] switches on the panel of the console.

## ■ USER DEFINE



- ① **Select buttons**  
Click the ◀/▶ buttons to switch the items that are displayed. If you click the middle, you will return to the CONSOLE STATUS display.
- ② **User define buttons**  
These list the functions that are assigned to the USER DEFINE [1]–[8] switches in the USER DEFINE block of the console. You can also click a button to execute the corresponding function.



Functions for the USER DEFINE [1]–[8] switches can be assigned in the UTILITY function USER DEFINE screen.

## ■ CONSOLE GPI IN

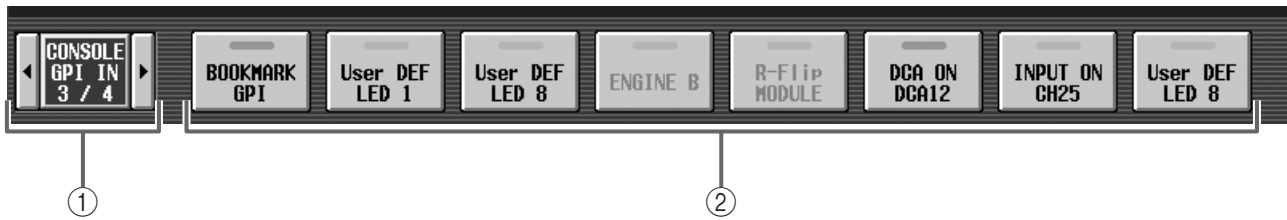

### ① Select buttons

Click the ◀/▶ buttons to switch the items that are displayed. If you click the middle, you will return to the CONSOLE STATUS display.

### ② Console GPI IN test buttons

These buttons list the functions that are assigned via the GPI connector of the console to GPI IN (ports 1–8). You can also click a button to test the corresponding function (→p.40).



- Functions for the GPI IN test buttons can be assigned in the MIDI/GPI/TC function GPI screen.
- Even if you are not using the GPI port, you can use these buttons in place of the USER DEFINE switches by assigning functions to the GPI IN test buttons.

## ■ ENGINE GPI IN

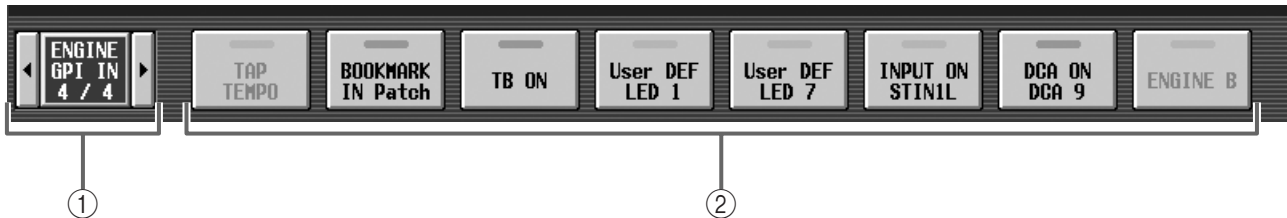

### ① Select buttons

Click the ◀/▶ buttons to switch the items that are displayed. If you click the middle, you will return to the CONSOLE STATUS display.

### ② Engine GPI IN test buttons

These buttons list the functions that are assigned via the GPI connector of the engine to GPI IN (ports 1–8). You can also click a button to test the corresponding function (→p.40).



- Functions for the GPI IN test buttons can be assigned in the MIDI/GPI/TC function GPI screen.
- Even if you are not using the GPI port, you can use these buttons in place of the USER DEFINE switches by assigning functions to the GPI IN test buttons.

⚠ Since the GPI IN of the engine can be controlled only from console 1, the GPI IN test buttons will not be displayed in DUAL CONSOLE mode if console 2 is specified. However in PM1D Manager, the display is not restricted even if console 2 is specified in DUAL CONSOLE mode when OFFLINE.

---

## DUAL CONSOLE mode added

---

As an operation mode of the PM1D system, version 1.5 adds Dual Console mode, in which two console are used by one system. The functionality and operation of Dual Console mode is explained below.

In the following explanation, functions and operations that apply only to console 1 are indicated as [Console 1], and functions and operations that apply only to console 2 as [Console 2].

 If the console (CS1D) you are using was manufactured before June 2002, you may be unable to select Dual Console mode even if connections are correct. In this case, you will need to have a gate array rewritten in order to use Dual Console mode. Please contact your Yamaha dealer.

It is necessary to have the gate array rewritten only if you wish to use Dual Console mode. If you are using the system in other modes, rewriting is not necessary, and you may continue using the system without change.

---

### About Dual Console mode

---

Dual Console mode is a mode in which two consoles (CS1D) are used in a single PM1D system. In this mode, two consoles share one (in standard mode) or two (in mirror mode) engines (DSP1D-EX {DSP1D}). Here are some examples of how Dual Console mode can be used:

- **Use two consoles to control the main mix and monitor mix**  
In this application, the same input channels are patched to the panels of both consoles. One engineer controls the main mix, and another engineer controls the monitor mix.
- **Use two consoles to control the same mix from two locations**  
In this application, two consoles are placed in separate locations (for example one near the stage and the other in the audience seating), and two engineers control the same mix.
- **Use two consoles to control 96 channels simultaneously**  
In this application, input channels 1–48 are patched to one console, and input channels 49–96 to the other console, allowing one or more engineers to control 96 channels simultaneously.

In Dual Console mode, the console that is connected to the engine will operate as the master unit, and the other console will operate as the slave unit. However, in order to avoid confusion with the master/slave relationship in “engine cascade” (described later in this document), we refer to the master unit as “console 1,” and the slave unit as “console 2.”

Console 1 and console 2 differ in the functions they can control, and in the order of priority when operations overlap. The differences between consoles 1 and 2 can be summarized as follows.

- **Items that are linked between consoles 1 and 2**  
In general, changes that you make to the mix parameters in the current scene are linked between consoles 1 and 2. (An operation on one console will be reflected by the other.) Operations of console 2 will not nullify operations of console 1. Even if differences occur between the states of console 1 and console 2, the engine will always be set according to console 1. If a difference occurs between parameters that should be linked, you can select whether to copy all scenes and all libraries when connection occurs, or to copy them as desired after connection.
- **Items that are operated independently between consoles 1 and 2**  
Channel selections by the [SEL] switches, changes in panel layout such as fader flip or module flip, and screen switching by the function switches are not linked between consoles. These operations can be made independently on each console.
- **Items that can be operated only by console 1**  
Most operations that affect the core of the system, such as switching between engines, switching the word clock master, and changing the connections between components, can be performed only by console 1. The settings of most items can be viewed on the console 2 screen, but cannot be modified.
- **PC connection**  
A PC (PM1D Manager) can be connected only to console 1 or to the engine. It cannot be connected to console 2. Nor is it possible to connect and use two or more PCs simultaneously.

Whether a parameter is linked when operated, and the priority between consoles 1 and 2, will differ depending on the screen. The table on the following page summarizes the operation of each screen in Dual Console mode.

Function	Screen	Linked		Independent	Remarks
		1→2	1↔2		
EFFECT			○		
GEQ			○		
SCENE	MEMORY		△		Only the trigger for number and store/recall operations is transmitted and received. SORT-related settings can be operated only on console 1
	RECALL SAFE		○		
	FADE TIME		○		
	DIRECT RECALL		○		
	TRACKING RECALL		○		
	GLOBAL PASTE	○			
MIDI/GPI/TC	MIDI PGM CHANGE		○		
	MIDI CTRL CHANGE		○		
	GPI	△			<ul style="list-style-type: none"> <li>• <b>GPI IN settings</b> Console 1 or PC: Only console 1 / engine port can be set Console 2: Only console 2 port can be set</li> <li>• <b>GPI OUT settings</b> Console 1 or PC: Only console 1 / engine port can be set Console 2: Only console 2 port can be set. However, engine port can be viewed</li> </ul>
	TC EVENT		○		
	FADER START		○		Cannot be set on a PC connected to a system that includes a console
UTILITY	PREFERENCE			○	
	USER DEFINE			○	From system software 1.5, this can be set/operated independently for consoles 1 and 2 and the PC
	LOAD / SAVE			○	There are limitations on the parameters that can be loaded by console 2
	PANEL ASSIGN			○	
	PAIR MODE	○			
SYS/W.CLOCK	SYSTEM CONNECTION	△			Buttons that switch the wiring of console 2 itself can also be operated from console 2
	DUAL CONSOLE	○			
	CASCADE		○		
	INPUT UNIT	△			Virtual units can be created only from console 1. Unit parameters are linked.
	OUTPUT UNIT	△			Virtual units can be created only from console 1. Unit parameters are linked.
	WORD CLOCK	○			
	DITHER		○		
UNIT NAME		○			
METER		△			METERING POINT and PEAK HOLD can be operated only from console 1
MON/CUE	TALKBACK			△	Only TB OUT is in common
	OSCILLATOR		○		The two consoles share one 2CH set of oscillators.
	2TR IN	△			Settings other than INPUT CONSOLE can also be operated from console 2
	ST OUT DIGITAL		○		
	MONITOR A			○	
	MONITOR B	—	—	—	Cannot be operated, since in Dual Console mode, this functions as MONITOR A of the other console
	CUE/SOLO			△	Cue is independent, solo function on/off can be operated only from console 1 Linked if the CUE MODE button is set to SOLO ON, or if in the SYS/W.CLOCK function DUAL CONSOLE screen CUE ON/OFF is turned ON.

Function	Screen	Linked		Independent	Remarks
		1→2	1↔2		
OUT PATCH	OUTPUT PATCH		○		If a discrepancy occurs between the patching when a scene/unit is recalled, the patching of console 1 will take priority
	INSERT PATCH		○		
	INSERT POINT		○		
	INSERT VIEW		○		
	NAME		○		
OUT INSERT			○		
OUT EQ			○		
OUT COMP			○		
OUT DELAY			○		
OUT DCA MUTE			○		
MATRIX/ST			○		
OUT CH VIEW			○		
IN PATCH	INPUT PATCH		○		If a discrepancy occurs between the patching when a scene/unit is recalled, the patching of console 1 will take priority
	DIRECT OUT PATCH		○		
	INSERT PATCH		○		
	INSERT/DIRECT POINT		○		
	INSERT/DIRECT VIEW		○		
	NAME		○		
HA/INSERT			○		
IN EQ			○		
IN GATE/COMP			○		
IN DELAY			○		
IN DCA/MUTE			○		
PAN/ROUTING			○		
INPUT CH VIEW			○		

- **Linked (1→2)** .....Screens in which the console 1/2 settings are linked. However, they can be operated only by console 1.
- **Linked (1↔2)** .....Screens in which the console 1/2 settings are linked. They can be operated from either console 1 or 2.
- **Independent** .....Screens in which settings can be made independently by consoles 1 and 2.
- **○** .....Indicates that all parameters in the corresponding function/screen will operate as indicated (independent, linked 1→2, or linked 1↔2).
- **Δ** .....Indicates that some parameters in this function/screen are exceptions, and operate other than indicated.

### About scene/library memories

When a scene or library is stored or recalled on one console, the other will follow this operation. However, this simply means that a command of “recall scene number \*\*\*.\*” is transmitted to the other console; the result of the store/recall is not conveyed to the other console.

Thus, **in order to completely synchronize the two consoles, it is necessary to match the current memory (the scene, patch, units, names currently shown in the panel), the scene memories and libraries that are used, and some of the setup data.**

If this data does not match, scene/library recall operations may cause the settings of the current scene to become completely different between the two consoles.

Data can be synchronized between the two consoles in the following ways.

- **Transfer all data**  
In this method, all data is transmitted via the CONTROL I/O connector from console 1 to console 2. You can perform this operation in a single step when you initiate Dual Console mode.
- **Transfer only necessary data**  
In this method, only the scenes and libraries that will be used are manually transmitted from console 1 to console 2.
- **Transfer all data via memory card**  
In this method, all data of console 1 is saved on a memory card, and this data is then loaded into console 2. To use this method, use the LOAD/SAVE screen of console 1 to save all data on a memory card, then insert that card into console 2 and load the data. (For details, refer to “CS1D Reference Manual (Software),” p.40.)

## About the console shutdown function

A Shutdown function has been added to keep current memory from being modified in Dual Console mode. In Dual Console mode, powering-off either console may modify the current memory of the other console or the engine, but by shutting-down the console before powering it off, you can prevent current memory from being modified.

For the procedure, refer to page 26.

- ⚠ • This shutdown function is necessary only in Dual Console mode. If you are not operating in Dual Console mode, the SHUTDOWN button (→p.26) will not be displayed.
- If you power-off the console without performing this procedure as described, the current memory used by the other console or the engine may be modified. However, settings other than current memory (i.e., scene memory, the various setup memories and libraries) will not be affected. Thus, if you have stored the current memory to a scene, you can re-recall that scene to recover from an accidental power-off that occurred without performing the shutdown.

## DUAL CONSOLE screen

PM1D system software V1.5 adds a DUAL CONSOLE screen to the SYS/W.CLOCK function. In this screen you can make settings and perform operations for Dual Console mode.

The screenshot displays the 'SYS/W.CLOCK' screen in Dual Console mode. At the top, it shows 'CONNECTION 1 A B', 'PANEL STATUS' (13-24ST3-437-48, 1-12ST1-225-36), and 'SCENE MEMORY 20.0 ENCORE\_M2'. Below this is a 'SYSTEM CONFIGURATION' bar with 'DUAL CONSOLE [CONSOLE 1]', 'MIRROR MODE', and 'CASCAD OFF'. The main area is divided into several sections:

- DUAL CONSOLE PARAMETERS:** Includes 'DUAL CONSOLE LINK' and two 'OFF' buttons for 'CUE ON/OFF' and 'TALKBACK DIMMER ON/OFF'.
- DATA VERIFY:** Shows 'ALL DATA STATUS' with 'UPDATE' and 'DIFF' buttons.
- SCENE MEMORY DIFF:** A list of memory items with their status:
 

SCENE MEMORY	DIFF
UNIT LIBRARY	DIFF
PATCH LIBRARY	DIFF
NAME LIBRARY	SAME
INPUT CH LIBRARY	SAME
OUTPUT CH LIBRARY	SAME
INPUT EQ LIBRARY	SAME
OUTPUT EQ LIBRARY	SAME
INPUT GATE LIBRARY	SAME
INPUT COMP LIBRARY	SAME
OUTPUT COMP LIBRARY	SAME
EFFECT LIBRARY	SAME
GEQ LIBRARY	SAME
- CURRENT MEMORY:** A table comparing Console 1 and Console 2:
 

CONSOLE 1	COPY	CONSOLE 2	
ALL	1+2	ALL	SAME
- SCENE MEMORY Table:**

No.	CONSOLE 1	COPY	CONSOLE 2	DIFF
ALL	ALL	1+2	ALL	DIFF
00.0	Initial Data	1+2	Initial Data	SAME
00.1	Monitor Mix	1+2	Monitor Mix	SAME
00.2	Standard PA	1+2	Standard PA	SAME
00.3	House PA	1+2	House PA	SAME
00.4		1+2		SAME
00.5	Initial Data #2	1+2	Initial Data #2	SAME
00.6	Monitor Mix #2	1+2	Monitor Mix #2	SAME
00.7	Standard PA #2	1+2	Standard PA #2	SAME
00.8	House PA #2	1+2	House PA #2	SAME
00.9		1+2		SAME
01.0	1004M	1+2	1004M	SAME
01.1	1004S	1+2	1004S	SAME
01.2	1005	1+2	INTRO	DIFF
01.3	1010	1+2	INTRO2	DIFF

The bottom status bar shows 'CONSOLE STATUS 1 / 4', 'IN SEL CH 8', 'NAME MODE UNIT NAME CH NAME', 'MODULE PATT [L] PATT [R]', 'MIX SEND NO. MIX 1', 'MASTER FADER DCA', and 'OUT SEL MIX21'.

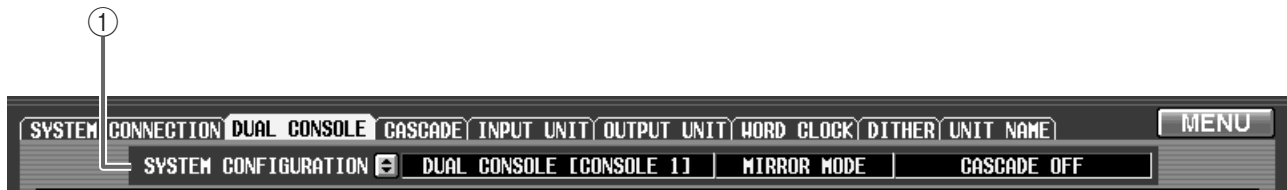

### ① SYSTEM CONFIGURATION

Indicates the current operation mode and cascade mode of the PM1D system. Click the  button to open the SYSTEM CONFIGURATION popup window, where you can switch the operation mode and cascade mode.



The SYSTEM CONFIGURATION field is displayed in the SYS/W.CLOCK function SYSTEM CONNECTION screen, DUAL CONSOLE screen, and CASCADE screen (newly added in version 1.5). All of these represent the same setting.

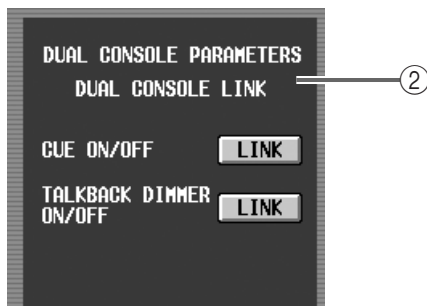

### ② DUAL CONSOLE LINK (DUAL CONSOLE mode link settings)

Here you can select whether cue operation and talkback-controlled dimmer operation will be linked.

If the CUE ON/OFF LINK button is on, operations of the [CUE] switches, EFFECT CUE, SUB IN CUE, and gate KEY IN CUE will be linked.

If the TALKBACK DIMMER ON/OFF LINK button is on, turning talkback on from one console will attenuate the monitor signal on the other console as well.

-  Note that the TALKBACK DIMMER ON/OFF LINK button links the dimmer operation; it does not link talkback on/off operation. The amount of attenuation when the dimmer is on can be adjusted independently in the MONITOR A screen of each console.

[Console 1]

The following screen appears only on console 1.

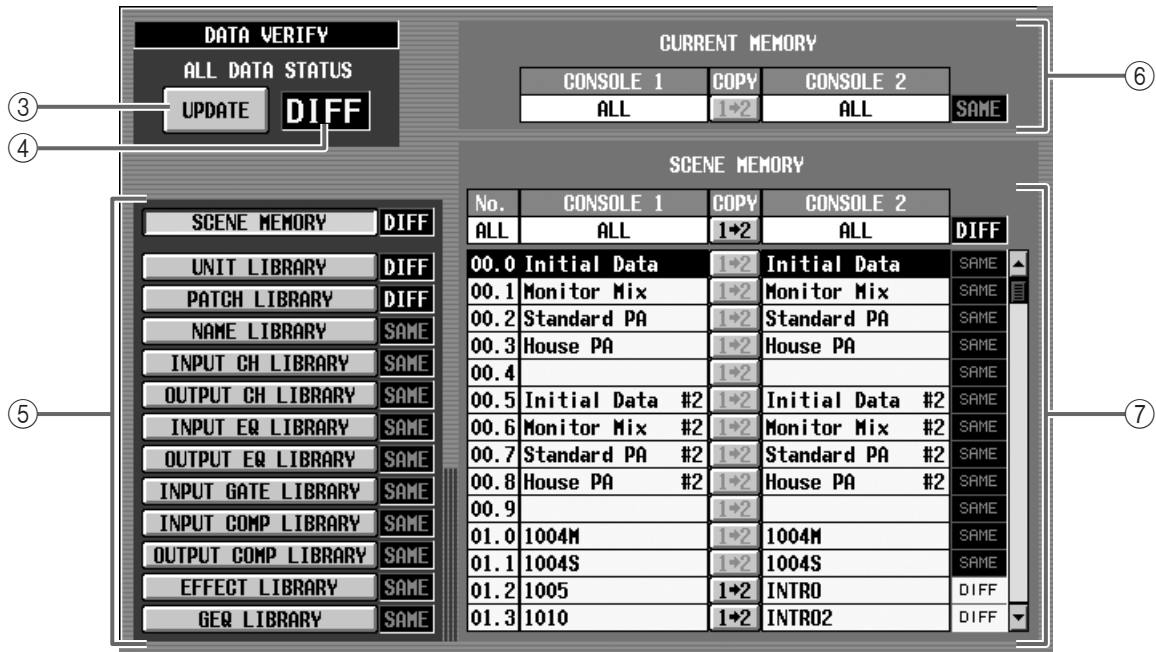

③ UPDATE

Each time you click this button, the current memory, scene memories/libraries, and setup data will be compared between console 1 and console 2, and the ALL DATA STATUS (④) display will be updated.

④ ALL DATA STATUS

This area displays the result of comparing the data of console 1 and 2. If all data is identical, this will indicate "SAME." If there is any difference, this will indicate "DIFF."

⑤ Scene memories / libraries

This area displays the result of comparing each scene memory and library. You can click the buttons at the left to select the items that will be displayed in the library data list (⑦).

⑥ CURRENT MEMORY (Current memory status)

This indicates the result of comparing the current memory (the scene currently reflected by the panel, patches, units, and names). If these are all identical for consoles 1 and 2, this will indicate "SAME." If there are any differences, this will indicate "DIFF." If you click the COPY **1+2** button located in the center, the current memory will be copied from console 1 to console 2.

⑦ Scene memory / library data list

This displays the scene memory / library data that is selected by the scene memory / library status (⑤) buttons.

The ALL field at the top of the list will indicate "SAME" if all data matches, or "DIFF" if there is any difference. If you click the COPY **1+2** button located in the center, the entire contents of the selected scene memory or library will be copied from console 1 to console 2.

The lower lines of the list show the contents of the selected scene memories / libraries for each console. If the contents of each number match, this will indicate "SAME." If they differ, this will indicate "DIFF." Only while a scene memory is displayed in the list, clicking the COPY **1+2** button located in the center will copy the contents of that scene memory from console 1 to console 2.



## Connections in Dual Console mode

The following diagrams show connections between the consoles and engine(s) in Dual Console mode.

- ⚠ • You must power-off all equipment before making connections.
- Connections for input/output units and power supplies are not discussed here. For details, refer to “CS1D Operation Manual, Setup.”

- ⚠ Please note that on console 2 you will connect the DIGITAL I/O lines to the DIGITAL I/O ENGINE A ports — not to the DIGITAL I/O CONSOLE ports.

[Standard mode]

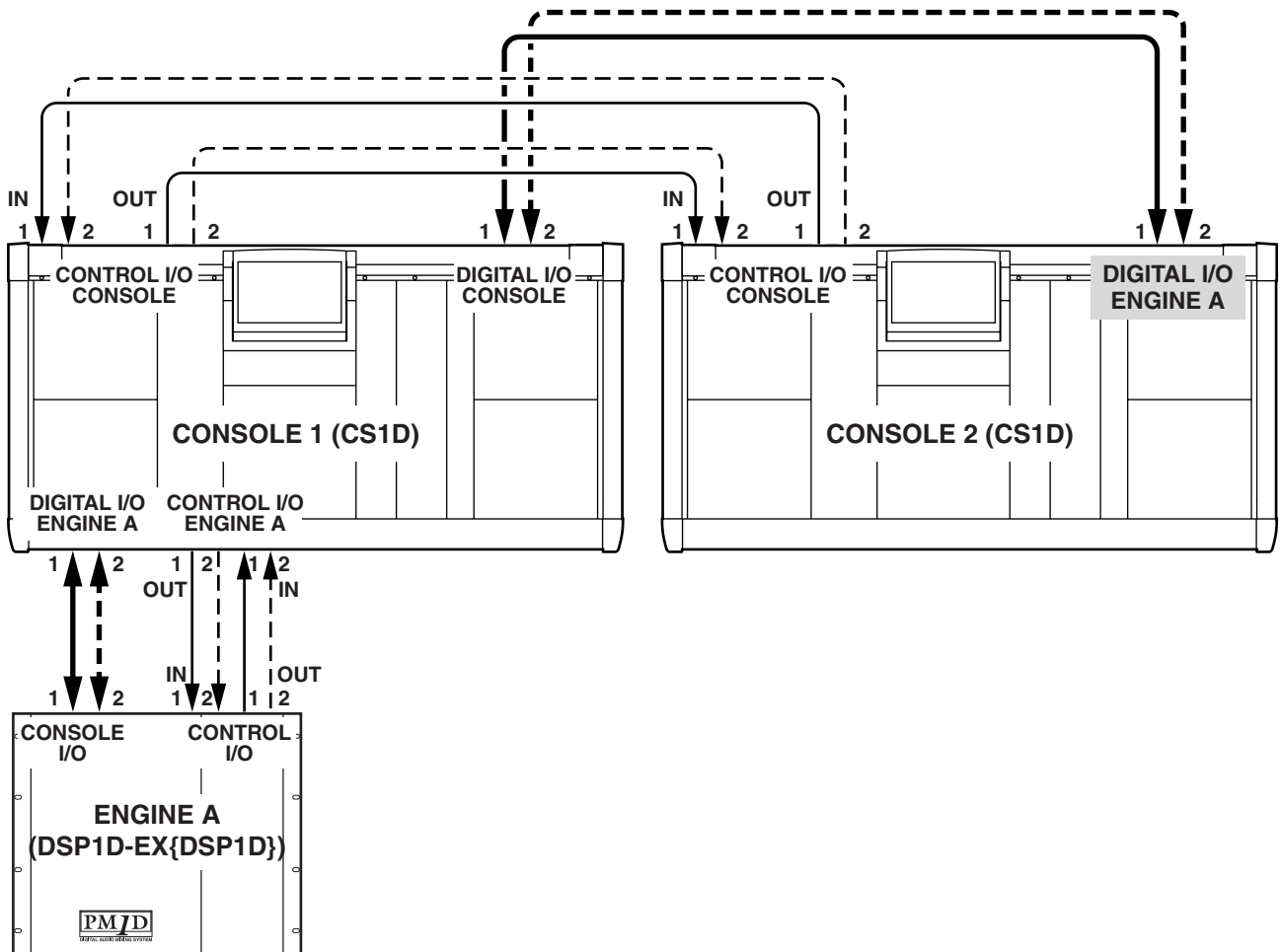

[Mirror mode]

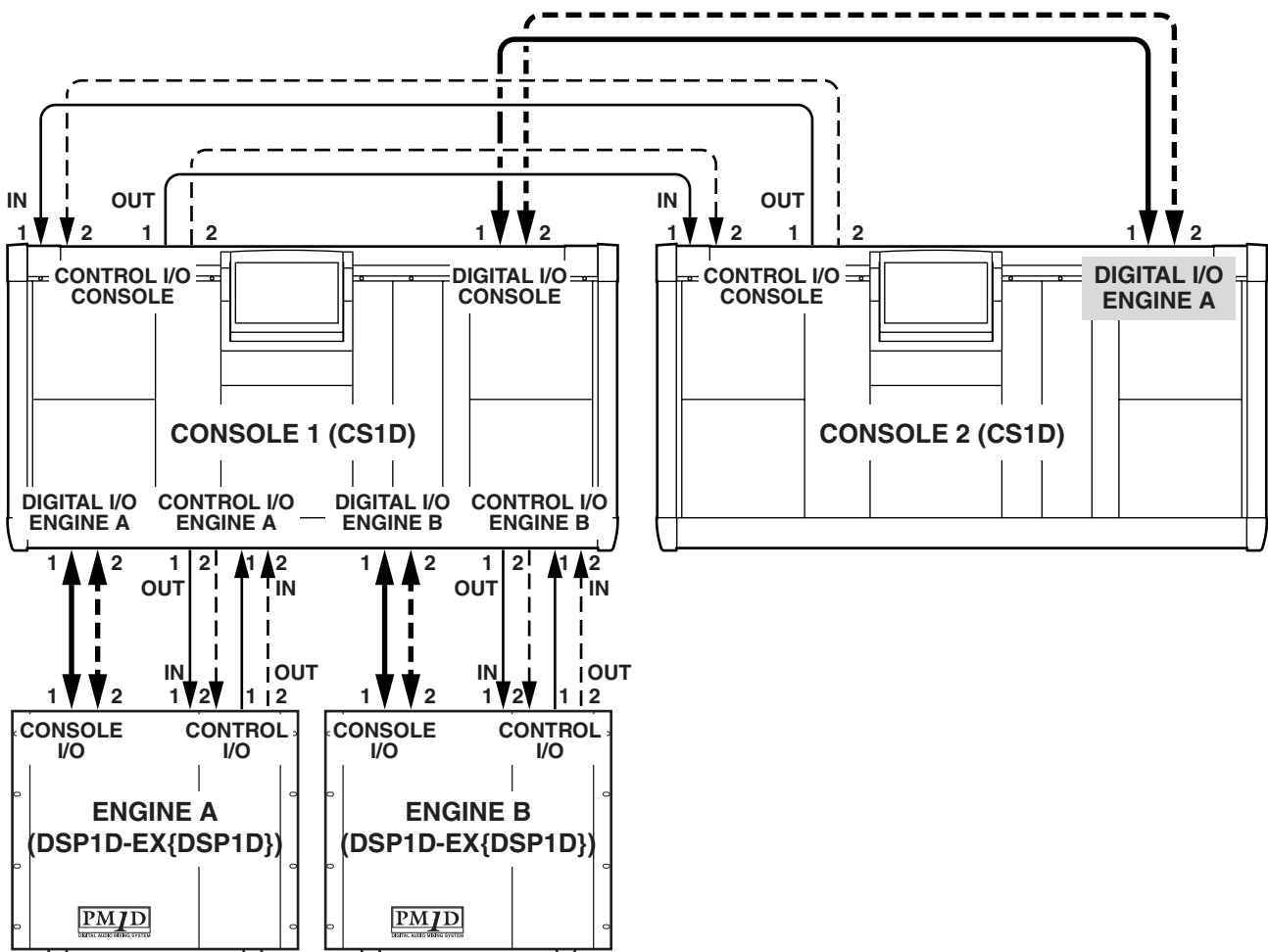

- The dashed lines in the above diagram are spare connections for use in the event that the currently-valid connectors become unusable.
- The system will operate normally even with just the connections shown by the solid lines. However, **we recommend that you also make the spare connections** shown above whenever possible.



Connect each device to the identically-numbered (1 or 2) connector on each device. The system will not operate correctly if you connect differently-numbered connectors.

## Establishing communication between consoles

This section explains how to select Dual Console mode on each console, specify the console to which the engine is connected as “console 1,” specify the other console as “console 2,” and establish communication.

- ⚠ In order to use Dual Console mode, each console number must be specified correctly. Be aware that communication will not occur if consoles 1 and 2 are interchanged, or if both are set to console 1.

1. Turn on the power in the order of input/output units, engine(s), and console power supply.

- ⚠ Incorrect operation while making settings can cause a high-volume signal to be output. **We strongly recommend that you turn down the volume of your power amps etc. until settings are completed.**

[Console 2]

- On the console to which the engine is not connected, access the SYS/W.CLOCK function DUAL CONSOLE screen (a newly added screen in version 1.5).
- In the SYSTEM CONFIGURATION field, click the  button.



The SYSTEM CONFIGURATION popup window will appear. In the OPERATION MODE SELECT area of this window you can select the operation mode of the PM1D system.

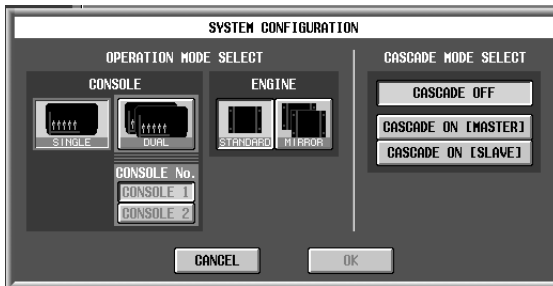

- Click the DUAL button within the CONSOLE section of the OPERATION MODE SELECT area. When you turn the DUAL button on, the CONSOLE No. buttons will become operable.

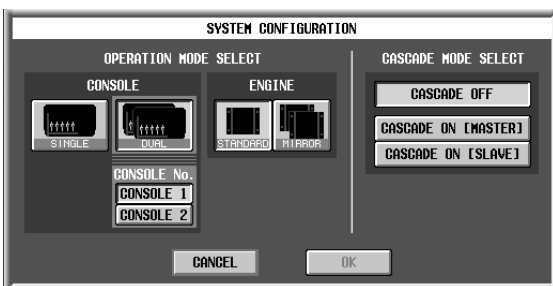

- Click the CONSOLE 2 button to turn it on, and then click the OK button. The console will be set to DUAL CONSOLE mode. In the upper part of the screen, the control number of the CONNECTION field will change to “2,” and “DUAL” will be indicated below the number. (However, an X will be superimposed on DUAL since communication is not yet established.)



[Console 1]

- On the console to which the engine is connected, access the SYSTEM CONFIGURATION popup window in the same way.
- Click the DUAL button within the CONSOLE section of the OPERATION MODE SELECT area.

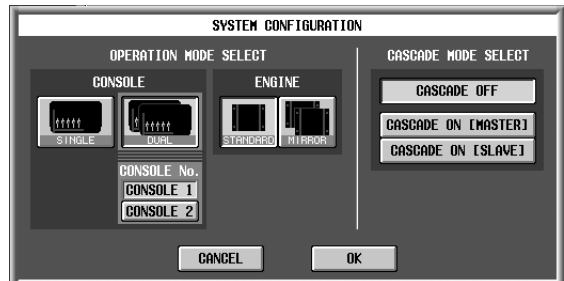

- Verify that the CONSOLE 1 button is on, and click the OK button.

When you click the OK button, the two consoles will attempt to establish communication. When communication has been established, console 1 will compare the system version, scene memories, libraries, and setup data of the two consoles.

- In order to use Dual Console mode, both consoles must have the same system version.
- If the versions of the two consoles differ, the version check popup window will appear, and further operation will not be possible. Update the system version to match, and perform the operation once again.

If there is any difference in the data of the two consoles, the console 1 screen will show a message of “Will transmit differential data to CONSOLE 2. Are you sure? [xx sec.]”

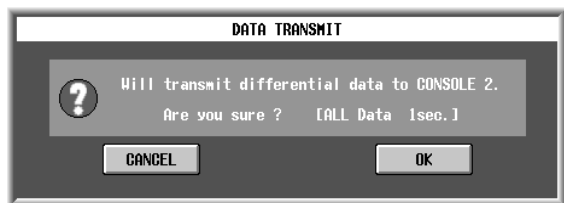

This message is asking you whether it is OK to transmit the differing data from console 1 to console 2. (The data is always sent from console 1 to console 2. The [xx sec.] (or [xx min.]) indicates the estimated time required for transmission.

When you click the OK button in this window, all current scene, scene, memory, and library data, and any setup data required for linked operation will be transmitted from console 1 to console 2.

If you click the CANCEL button, only the current scene and the setup data necessary for linked operation will be transmitted from console 1 to console 2.



If the scene memories and libraries are fully used, it will take approximately 60 minutes to transmit all of the data.

**CAUTION!**

- Be aware that once data transmission is started, it cannot be aborted. Please use caution.
- The expected time is merely an estimate. A longer time than indicated here may actually be required.
- If you do not have enough time for transmission to be performed, we strongly recommend that you click the CANCEL button when the above message appears, and either transmit only the necessary data (→p.21) or transfer the data via memory card.

If, after communication is established, communication with the DIGITAL I/O connector or CONTROL I/O connector is interrupted, a warning message like the following will appear in the lower part of the screen. Please check the appropriate connection.



9. If it is OK to transmit the data, click the OK button. Data transmission will begin. The screen will show a progress bar to indicate the state of progress.

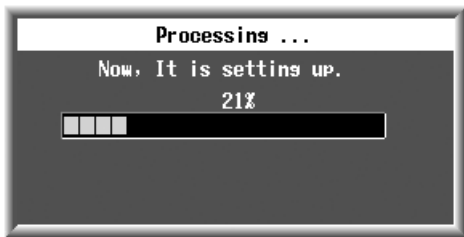

- ⚠ While transmission is occurring, never turn off the power or interrupt communication. If for some reason the console power supply is turned off, the memory contents of console 2 will be lost. In this case you will need to initialize console 2.
- Even if you click the CANCEL button in step 9, part of the setup data and the current data will be transmitted, so as long as you are operating the current scene, the two consoles will operate in tandem. However, since the libraries and scene do not match, performing a store/recall operation may cause the current scene on the two consoles to have completely different settings.

When transmission is completed, the X symbol will disappear from the “DUAL” indication in the CONNECTION area at the top of the screen. Now the two consoles can be used simultaneously.



- If you power-off the system in this state, console 1 will attempt to initiate communication in Dual Console mode the next time it is powered-on.
- To cancel Dual Console mode, access the DUAL CONSOLE screen on console 1 or 2, click the  button in the SYSTEM CONFIGURATION field, and select SINGLE CONSOLE mode. If Dual Console mode is established, switching to Single Console mode will set both console 1 and console 2 to Single Console mode.

## Transmitting only the necessary scenes / libraries

After establishing Dual Console mode communication, you can transmit only the necessary scene memories and libraries from console 1 to console 2. Even if you have cancelled transmission of all data after starting-up Dual Console mode, you can use this method to transmit only the minimum scenes and libraries.

 The following procedure can be performed only on console 1.

[Console 1]

1. **On console 1, access the SYS/W.CLOCK function DUAL CONSOLE screen.**

2. **In the ALL DATA STATUS section, click the UPDATE button.**

The memory contents of consoles 1 and 2 will be compared. If they match perfectly, an indication of “SAME” will appear at the right of the UPDATE button. If there is any difference, an indication of “DIFF” will appear.

3. **Click the scene memory / library status buttons to select the scene memory / library that you want to transmit.**

The contents of the selected scene memory / library will appear in the list at the right. If the identically-numbered data matches between consoles 1 and 2, the field at the right will indicate “SAME.” If the data does not match, this field will indicate “DIFF.”



If no data has been saved in the identically-numbered memory of either console 1 or 2, this field will indicate “SAME.”

4. **Click the COPY (  ) button for the number that you want to transmit.**

The corresponding data will be copied from console 1 to console 2. Perform the same operation for other numbers as desired.



- When copying a scene memory, you must also copy the unit, patch, and name libraries used by each scene.
- Individual numbers of library data cannot be copied. The entire library will be copied as a whole.

## Limitations of Dual Console mode

This section explains the limitations of Dual Console mode.

### ■ Operation when the current memory does not match

Dual Console mode can be used even if the current memory (the scene, patches, units, and names currently reflected by the panel) does not match. In this case, editing a linkable parameter from one console will cause only the identical parameter on the other console to change as well.

For operations such as setting/disabling a pair, switching a MIX bus between VARI/FIX, and copying between channels, only the appropriate number and command are transmitted. If the received command conflicts with the console’s own current memory, the setting of console 1 will always take priority. In this case, the lower part of the console 2 will indicate “DATA TYPE CONFLICT! EXCLUDED,” and it will not be possible to edit the parameter on console 2.

Popup windows that ask you to change an internal setting (such as switching units) will always appear only on console 1. When you execute such a change on console 2, a message will ask you for confirmation.

### ■ Scene memory store/recall operations

When you perform a scene memory store/recall operation on one console, the corresponding number along with a store/recall command will be transmitted to the other console. (The other console is not informed

whether the current memory or scene memory matches following execution.)

This means that if changes occur in the contents of scene memory, discrepancies may occur between the current memories of the two consoles following a recall operation. Please be aware of this possibility.

Recall Undo or Store Undo can be performed from either console. However if the scene memories are not synchronized at the time of initial connection in Dual Console mode, the scene number that is recalled by Recall Undo may differ. In this case, undo will occur with differing scene memories, and the engine will follow the data of console 1.



Store Undo cannot be performed immediately after Dual Console mode initial connection occurs.

### ■ Preview mode

Scene memory Preview mode can be operated independently from either console. If one console is switched to Preview mode, and an edited scene is stored, all data of the corresponding scene will be copied to the same scene number of the other console (the store-destination scene will match).

### Library store/recall operations

When you perform a library store/recall operation on one console, the corresponding number along with a store/recall command will be transmitted to the other console. (The other console is not informed whether the library or current memory matches following execution.)

This means that if changes occur in the library contents, discrepancies may occur in the current memories of the two consoles following a recall operation. Please be aware of this possibility.

As an exception, if you open the LIBRARY popup window on one console, edit the parameters directly and then store, the data of the corresponding library will be copied to the same library number on the other console. (The store-destination library will match.)

### File load/save operations

In Dual Console mode, you can use the LOAD/SAVE screen to load/save data from or to a memory card on either console. However on console 2, there are slight limitations on the data that can be loaded from a memory card.

The following table shows the items that can be loaded by each console in Dual Console mode.

Loaded item	Console 1	Console 2
Scene memory	○	○
Setup data	○	△ <sup>1</sup>
TC EVENT screen settings	○	X
MIDI PGM CHANGE screen settings	○	X
Libraries	○	○

○: Loadable    △: Partially loadable    X: Not loadable

1. Only the parameters that can be set independently for each console will be loaded. Parameters that are linked with console 1 will not be loaded.

### Engine selection in Mirror mode

When using the PM1D system in Mirror mode, switching between engines A and B can be performed only from console 1.

When the engine has switched, a message of “ENGINE HAS BEEN SWITCHED TO [A] ([B])” will appear at the bottom of the screen on console 2.

### Talkback

In Dual Console mode, two talkback systems can be operated independently from each console 1 and 2. (Talkback will function with a total of four inputs / two systems.)

For each console, you can use the MON/CUE function TALKBACK screen to adjust the input level, phase, and destination of the two talkbacks.

However, the settings of the TALKBACK screen TB OUT section will be shared by console 1 and 2. In this section, you can choose the talkback source as either CONSOLE 1 (talkback signal of console 1), CONSOLE 2 (talkback signal of console 2), or CONSOLE 1+2 (talkback signals of consoles 1 and 2), and specify the desired port as the output destination. (This operation can be performed from either console.)

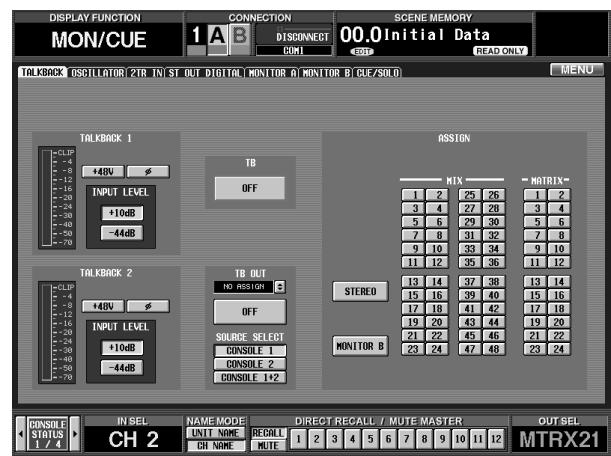

If the TALKBACK DIMMER ON/OFF LINK button is turned on in the DUAL CONSOLE screen of console 1, the dimmer will operate on the other console as well when talkback is turned on by one console. However even in this case, talkback on/off operation is not linked. The amount by which the signal is attenuated when the dimmer is on can be adjusted independently for each console in the MONITOR A screen.

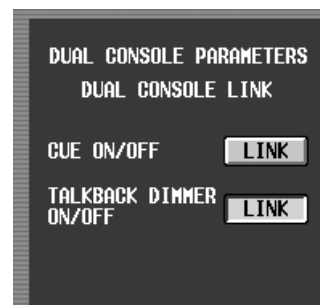

## ■ Monitor

In Dual Console mode, one of the two monitor buses A and B can be assigned to each console 1 and 2, and controlled independently.

The monitor bus controlled by the console itself is assigned to MONITOR A, and the monitor bus con-

trolled by the other console is assigned to MONITOR B. This means that **from either console, monitor-related settings will be performed in the MONITOR A screen (and the MONITOR A section of the panel).**

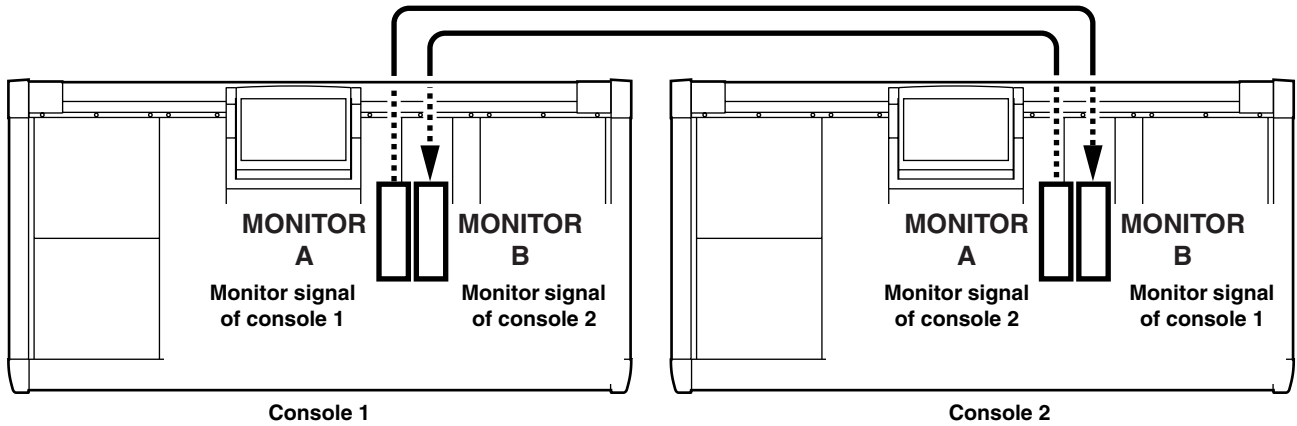

- ⚠ On either console, the MONITOR B screen will be unavailable in Dual Console mode, and no parameters will be displayed.
- The MONITOR B SOURCE section of the panel will only indicate the source that is being monitored by the other console, and cannot be operated. However, the MONITOR B [LEVEL] knob, MONITOR B [ON] switch, and MONITOR B [PHONES] knob can be operated. (If desired, you can monitor the same source as the other console.)

## ■ Cue

In Dual Console mode, cue operations can generally be performed independently. Also, the [LAST CUE] switch on the panel and the CUE/SOLO screen LAST CUE button can also be operated independently for each console.

However, if in the DUAL CONSOLE screen the CUE ON/OFF LINK button (→p.15) is turned on, all cue operations ([CUE] switch on/off, EFFECT CUE, SUB IN CUE, gate KEY IN CUE) will be linked. This method is convenient when one engineer is operating both consoles.

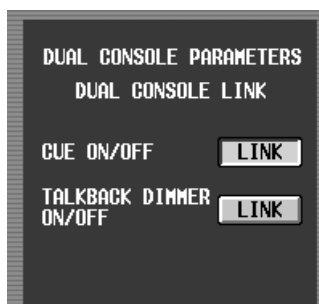

- ⚠ When cue operations are linked, you can enable key in cue so that the gate key-in signal of the currently selected input channel can be monitored from both consoles. However **in Dual Console mode, [SEL] key operations are not linked, meaning that the selected signal source may differ. Please use caution.**

If effect cue for a certain internal effect (for example, internal effect 3) is enabled on one console, effect cue will be cancelled when you switch screens on that console or if you select the same screen (the EFFECT 3 screen in this example) on the other console and then switch screens. The reason for this design is that otherwise, when the screen is switched, it would become impossible to know which effect cue was being monitored.



As an exception, effect cue will not be cancelled if you switch alternately between the EFFECT 1–8 screen that is enabled for effect cue and the EFFECT ASSIGN screen. The reason for this design is that in the EFFECT ASSIGN screen, you can see which effect cue is being monitored.

In the same way, if you enable SUB IN cue in the SUB IN screen of one console, SUB IN cue will be cancelled if you switch screens on the same console or if you select the same SUB IN screen on the other console and then switch screens.

■ **SOLO mode**

SOLO mode on/off can be control only from console 1. On console 2, the panel [SOLO] switch and the CUE/SOLO screen SOLO ON/OFF button will not function.

While SOLO mode is on, cue operations will be linked regardless of the state of the DUAL CONSOLE screen CUE ON/OFF LINK button (→p.15). (Pressing the [CUE] switch on either console will solo that source.)

In Dual Console mode, the panel [LAST CUE] switch can be operated independently from each console. However, the [LAST CUE] switch of consoles 1 and 2 will be linked if in the DUAL CONSOLE screen the CUE ON/OFF LINK button is turned on, or while SOLO mode is on. If the state of the [LAST CUE] switches differs between consoles 1 and 2 when you enter SOLO mode, the setting of console 1 will be copied to console 2.

■ **Meter operations**

In Dual Console mode, the METER function METERING POINT button and PEAK HOLD button, and the panel METER section [PRE] switch and [PEAK HOLD] switch will be linked. However, these buttons and switches can be operated only by console 1.

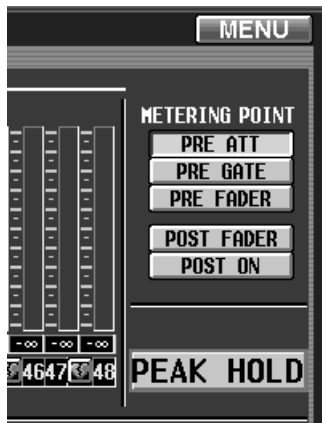

■ **Pair mode switching**

The pair mode can be switched only from console 1.

■ **INPUT UNIT / OUTPUT UNIT screen**

Units and cards can be changed only from console 1. The same content will be displayed in the screen of console 2, but cannot be edited. Nor can you specify virtual units or cards from console 2.

As an exception, only if console 2 is switched to PREVIEW mode, virtual units or cards can be created on console 2, and this content can be saved to a scene or unit library.

■ **Effect functions**

If the effect type of the same internal effect differs between console 1 and 2, changes made to the parameters of that effect will be ignored.

■ **OUT COMP function / IN GATE/COMP function**

If the compressor/gate type for the same channel differs between console 1 and 2, changes made to the parameters of that compressor/gate will be ignored.

If the KEY IN LEFT CH button is switched on for one console, this will be ignored if the corresponding channel is paired on the other console.

■ **MATRIX/ST ROUTING screen / SUB IN screen**

If pairing settings differ between console 1 and 2 for the same MATRIX channel, changes made to the send level / pan of the signal sent from a MIX channel / SUB IN to that MATRIX bus will be ignored.

■ **CH to MIX screen**

If pairing settings differ between console 1 and 2 for the same MIX channel, changes made to the send level / pan of the signal sent from an input channel to that MIX bus will be ignored.

■ **IN PATCH function / OUT PATCH function**

Even if the patching is switched on one console, the operation will be ignored if the corresponding card is not specified on the other console.

Also, in conjunction with the addition of Dual Console mode, you can now patch the talkback signal of CONSOLE 1 and CONSOLE 2 (IN PATCH and IN INSERT "IN" only).

The CONSOLE 1 talkback is displayed as TB C1, and the CONSOLE 2 talkback as TB C2. This can be viewed/set in Single Console mode as well as in Dual Console mode, but the TB C2 setting is valid only in Dual Console mode.

■ **IN HA/INSERT function / OUT INSERT function**

Even if a parameter for an individual card (e.g., gain, phase) is edited on one card, the operation will be ignored if the corresponding card is not specified on the other console.

Also, in conjunction with the addition of Dual Console mode, you can now patch the talkback signal of CONSOLE 1 and CONSOLE 2 (IN PATCH and IN INSERT "IN" only).

The CONSOLE 1 talkback is displayed as TB C1, and the CONSOLE 2 talkback as TB C2. This can be viewed/set in Single Console mode as well as in Dual Console mode, but the TB C2 setting is valid only in Dual Console mode.

■ **MIDI/GPI/TC function**

Time code / MIDI input can be selected for the ports of either console.



## GPI screen

The following restrictions apply to GPI IN/GPI OUT settings.

### GPI IN

On console 1 / PC (PM1D Manager), settings can be made only for the GPI port of console 1 and the engine. On console 2, settings can be made only for the GPI port of console 2.

### GPI OUT

On console 1 / PC, settings can be made only for the GPI port of console 1 and the engine. On console 2, settings can be made only for the GPI port of console 2. However, signals can be output from console 2 to the engine port.

## USER DEFINE/GPI function

User-definable switches and functions assigned to GPI IN can be set and operated independently from console 1 or 2. However for some functions, the following limitations apply.

### INC/DEC RECALL

The preceding or following scene will be recalled relative to the scene number that was last recalled/stored on console 1. Be aware of this when using this function on console 2.

### MONITOR B SELECT

While Dual Console mode is in operation, the MONITOR B SELECT function assigned to a user-definable switch or GPI IN is not valid.

### ENGINE B SELECT (GPI only)

The GPI IN test button assigned to the ENGINE B SELECT function cannot be operated from console 2.



The MONITOR A SELECT function can be set and operated from either console.

## FADER START screen

The settings of this screen cannot be made from a PC (PM1D Manager) connected to a system that includes a console.

## 2TR IN screen

In Dual Console mode, you can select which 2TR IN (of console 1 or console 2) will be used for each of the six 2TR IN inputs. **This selection can be made only from console 1.**

To switch the console whose 2TR IN jacks are being used, use the 2TR IN screen INPUT CONSOLE button. At this time, the Fs field will indicate the sampling frequency of the signal that is being input to the selected console.

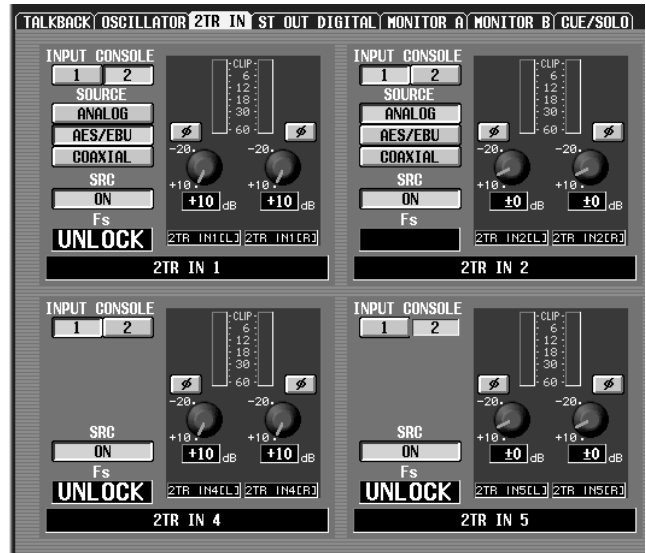

On console 2, the INPUT CONSOLE button will be masked, and cannot be operated. However, you can use either console to select the input source (2TR IN 1 / 2TR IN 2 only), switch the SRC (sample rate converter) ON/THROUGH, adjust the level, and switch the phase. These operations will be linked between console 1 and 2.

## ST OUT DIGITAL screen

In Dual Console mode, the same signals will be output from STEREO OUT A of both consoles and STEREO OUT B of both consoles. Thus, the settings in the ST OUT DIGITAL screen will be linked.

## SYSTEM CONNECTION screen

In general, routing changes in the SYSTEM CONNECTION screen can be performed only from console 1. However, routings connected to console 2 itself can be changed only from console 2.

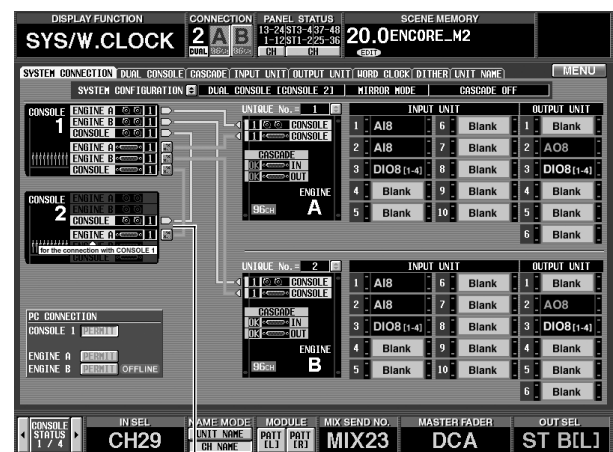

**Only this button can be operated from console 2**

If a routing change is executed from one console, a warning message will be displayed on the other console. All other SYSTEM CONNECTION screen settings (permission for PC connection, cascade connection enable/disable, standard mode / mirror mode selection, etc.) can be performed only from console 1.

### ■ DUAL CONSOLE screen

In the DUAL CONSOLE screen of console 2, you cannot compare or copy data between consoles 1 and 2. (The buttons and list in the right of the screen will not appear.)

Also, the buttons in the left of the screen for linking cue and dimmer operations will be displayed only, and cannot be operated.

### Powering-off the consoles

In Dual Console mode, use the following procedure to shut down before you power-off the consoles.

- ⚠ • This shutdown function is necessary only in Dual Console mode. If you are not operating in Dual Console mode, the SHUTDOWN button will not be displayed.
- If you power-off the console without performing this procedure as described, the current memory used by the other console or the engine may be modified. However, settings other than current memory (i.e., scene memory, the various setup memories and libraries) will not be affected. Thus, if you have stored the current memory to a scene, you can re-recall that scene to recover from an accidental power-off that occurred without performing the shutdown.

1. On the screen of the console that you want to power-off, press the MENU button to access the menu screen. The SHUTDOWN button will appear in the lower left.

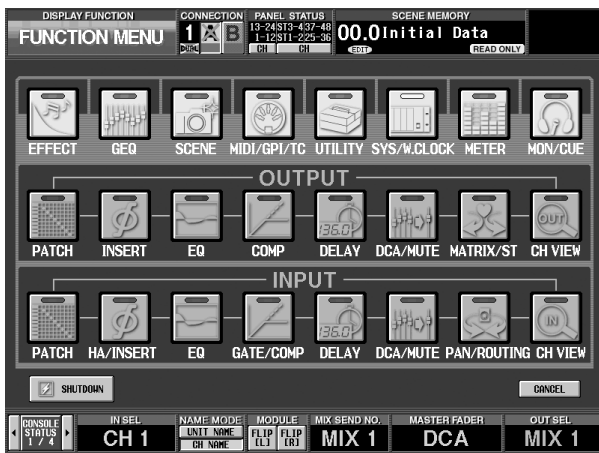

3. Press the OK button. The following screen will appear, and the panel LEDs will go dark. It is now safe to turn off the power. If you press the CANCEL button you will return to the menu screen.



2. Press the SHUTDOWN button, and the shutdown popup window will appear.

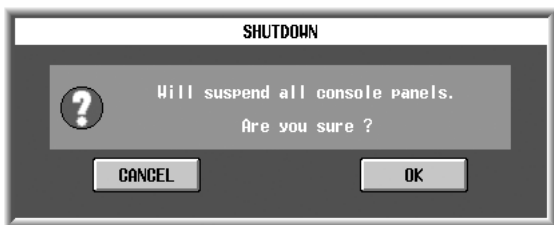

## Cascade connections

PM1D system software V1.5 allows you to cascade-connect two systems. Any desired buses can be connected between cascade-connected systems. This allows you to increase the number of input channels to a maximum of two engines.

### About cascade connections

Cascade connection is when the engines (DSP1D-EX {DSP1D}) of two PM1D systems are connected to each other to share buses. **Unlike cascaded analog consoles, in which the signals are sent uni-directionally, cascade connection on the PM1D system allows bi-directional audio output and communication.**

When cascade connection is used, one system must be designated as the “master” and the other system as the “slave.” However, the cascade master and slave differ only in the priority in which they are initially connected, and in actuality are completely equivalent in status.

Cascade connection involves virtually none of the restrictions that apply to Dual Console mode. There will be no problem even if scenes or library content differs. While there are no limitations on cascade-connecting a Single Console mode system with a Dual Console mode system, it is not possible to cascade-connect with either a Standard mode system or a Mirror mode system. In such cases you will have to set both PM1D systems to either Standard mode or Mirror mode.

**⚠** When using cascade connection, all consoles, engines, and PM1D Manager software must be using the identical system version. Before you make cascade connections, please check the version of each component.

### CASCADE screen

In PM1D system software V1.5, a CASCADE screen has been added to the SYS/W.CLOCK function. In this screen you can make settings for cascade connections.

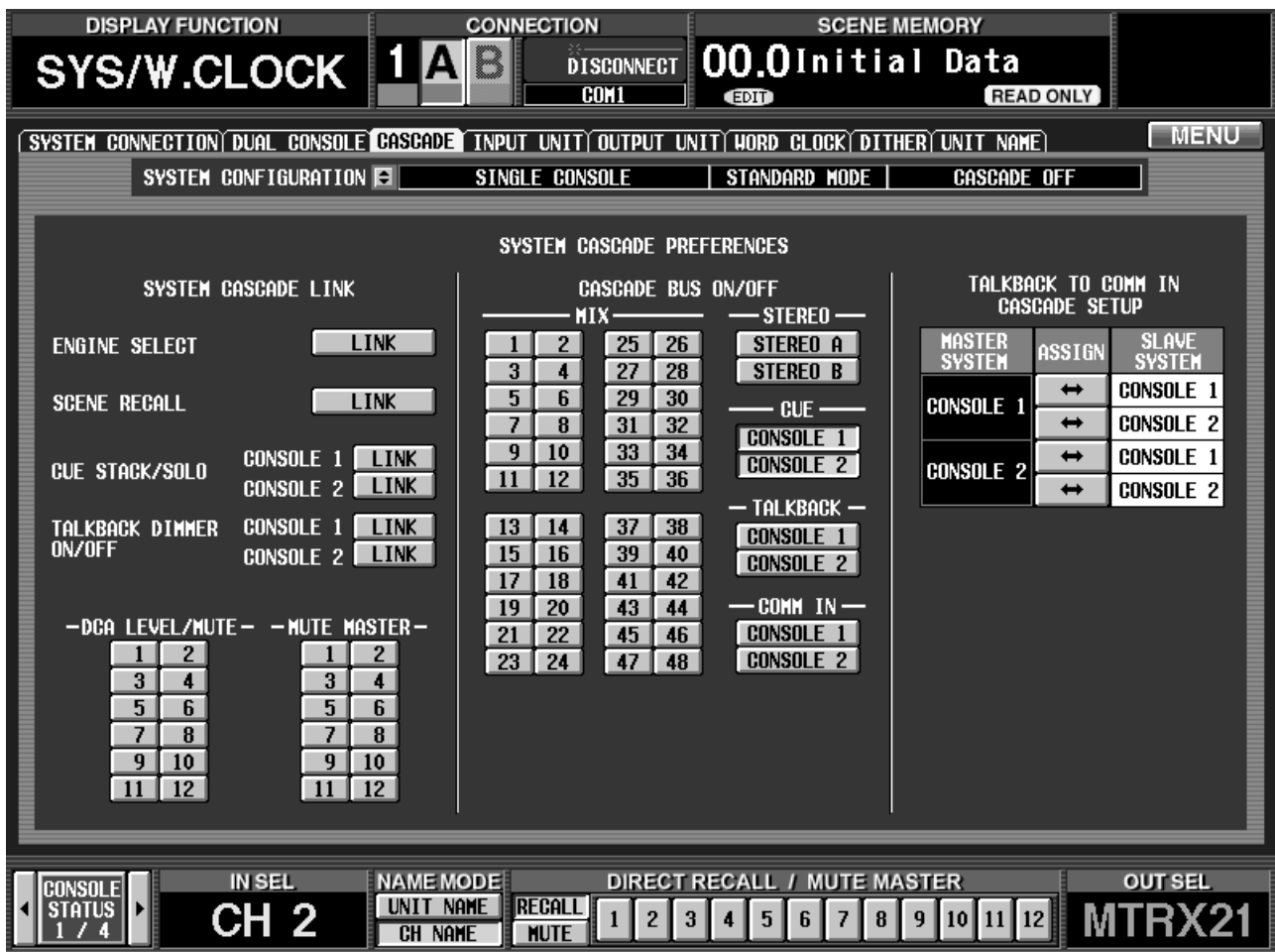

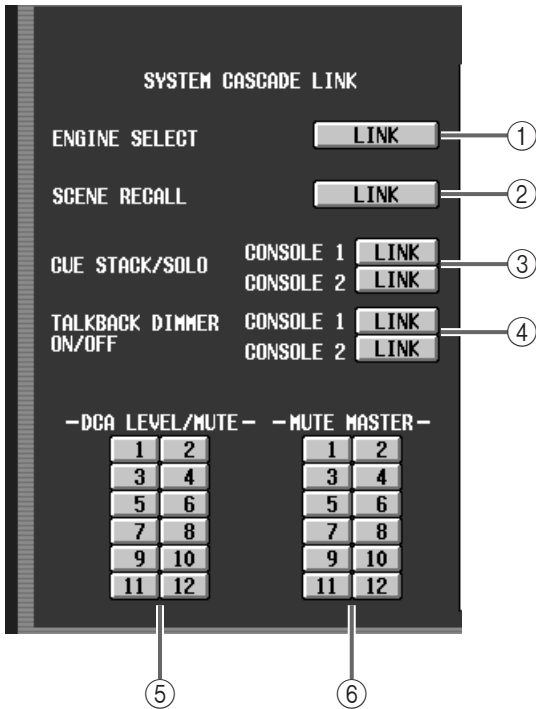

- ① **ENGINE SELECT**  
If the master and slave systems are being used in Mirror mode, this selects whether switching between engines A/B will be linked.
- ② **SCENE RECALL**  
Selects whether scene recall operations will be linked between the master and slave systems.  
If they are linked, the identically-numbered scene on the other system will be recalled.
- ③ **CUE STACK/SOLO**  
Selects whether cue operations and solo operations will be linked between master/slave consoles 1 and between master/slave consoles 2.
- ④ **TALKBACK DIMMER ON/OFF**  
Selects whether dimmer operation due to talkback will be linked between master/slave consoles 1 and between master/slave consoles 2.  
It is convenient to link the operation if the consoles are near each other and you want dimming to occur for both monitors when talkback is turned on.
- ⑤ **DCA LEVEL/MUTE**  
Selects whether the DCA group level and mute on/off state will be linked between master and slave systems. The DCA group(s) selected by these buttons will be linked.  
If CUE STACK/SOLO is linked, and you cue a DCA that is selected for DCA LEVEL/MUTE, the same DCA will be cued on both systems. However, if an input channel and output channel are assigned to the same DCA number, they will not be linked.
- ⑥ **MUTE MASTER**  
Selects whether the mute group on/off state will be linked between master and slave systems. The mute group(s) selected by these buttons will be linked.

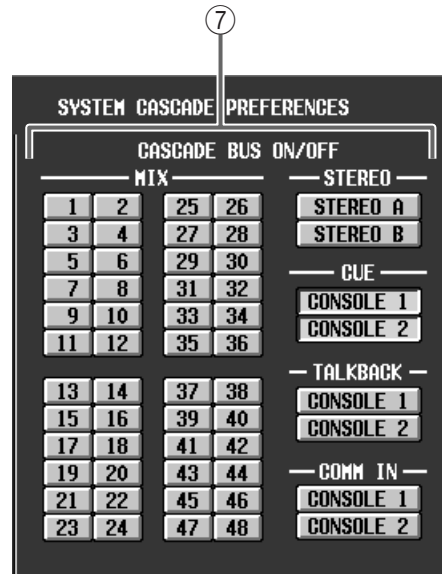

- ⑦ **CASCADE BUS ON/OFF**  
These buttons select the buses/signals that will be cascaded between the master and slave systems.

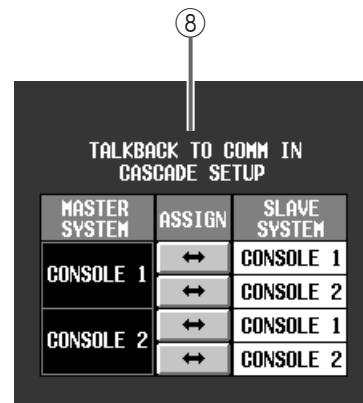

- ⑧ **TALKBACK TO COMM IN CASCADE SETUP (Talkback → COMM IN cascade settings)**  
These buttons select whether the talkback signal of the master system will be supplied as a COMM IN signal of the slave system. Settings for console 1 and 2 can be made independently for both master and slave.

## Cascade connections

The following diagrams show cascade connections for Standard mode, Mirror mode, and Standard mode + Dual Console mode.

- ⚠ You must power-off all devices before you make connections.
- Connections for input/output units and power supplies are not discussed here. For details, refer to “CS1D Operation Manual (Setup).”

[Standard mode]

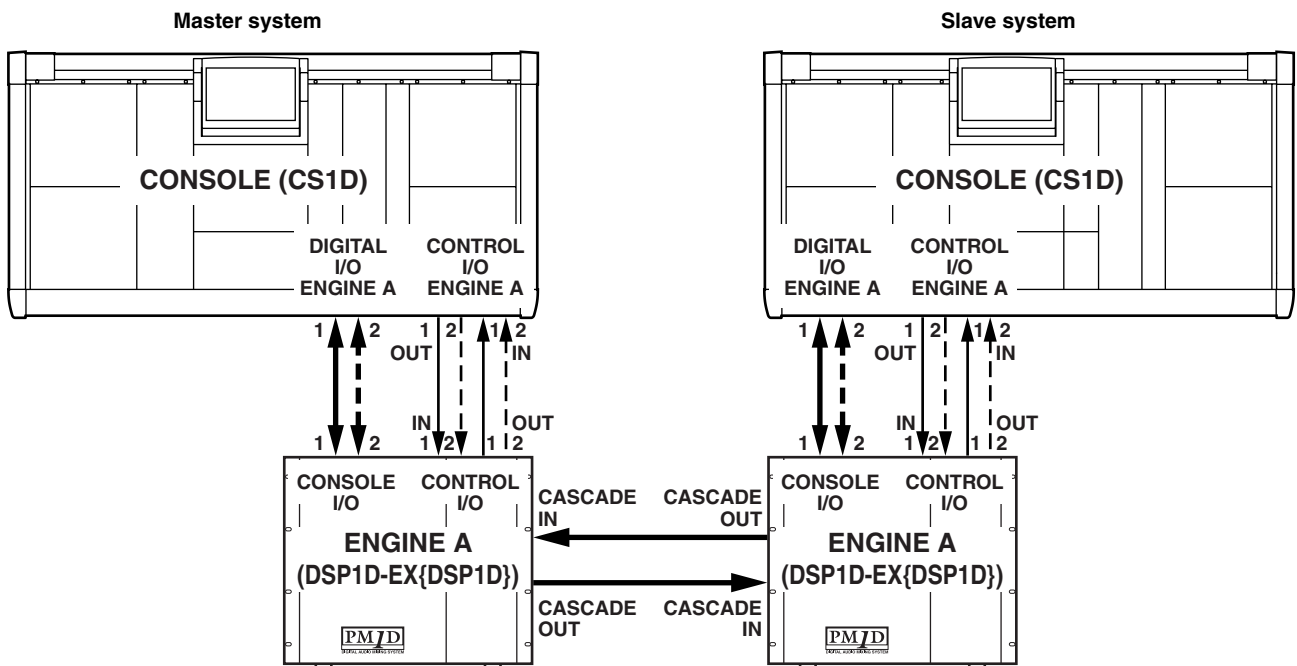

[Mirror mode]

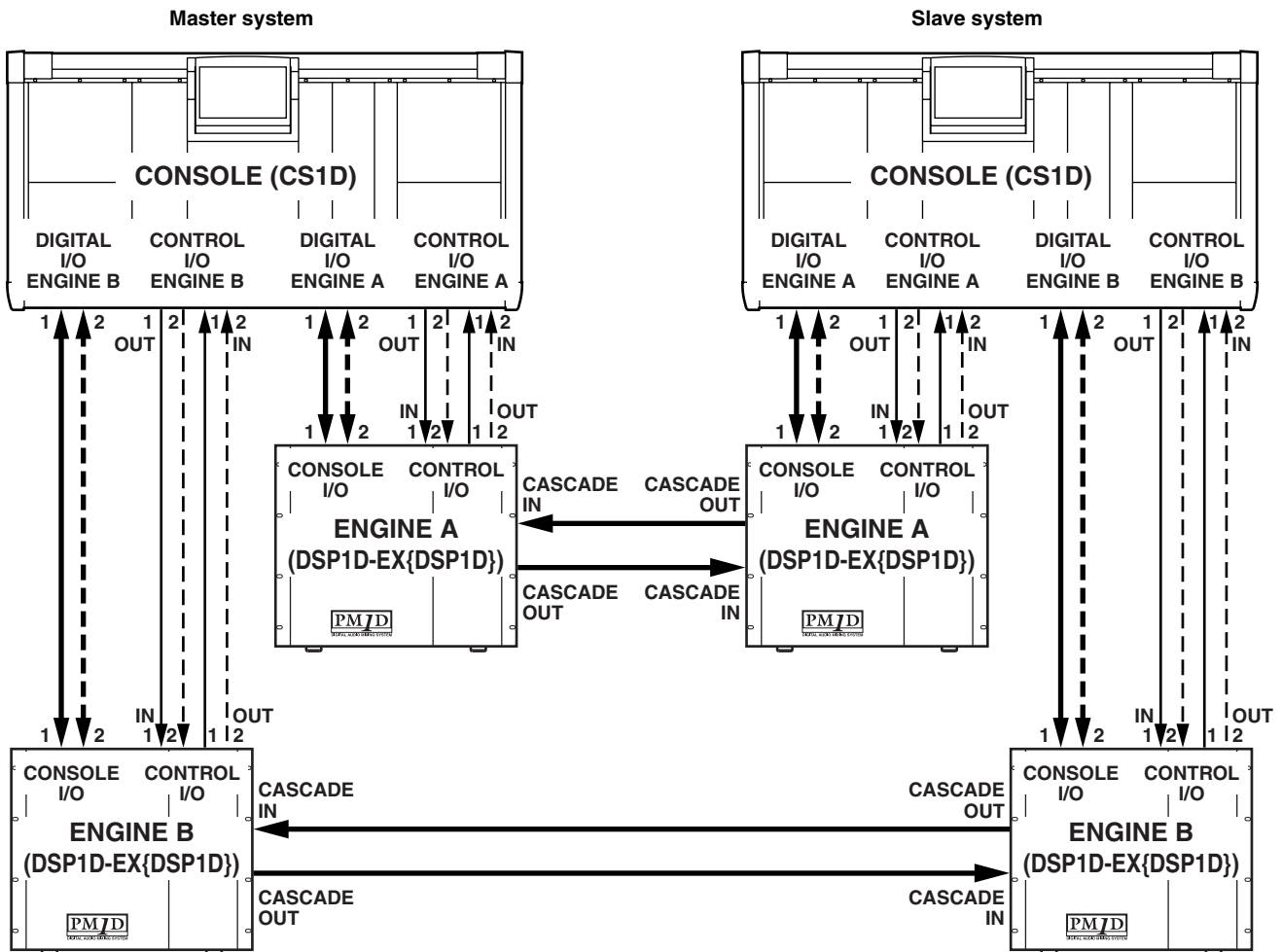

[Standard mode + Dual Console mode]

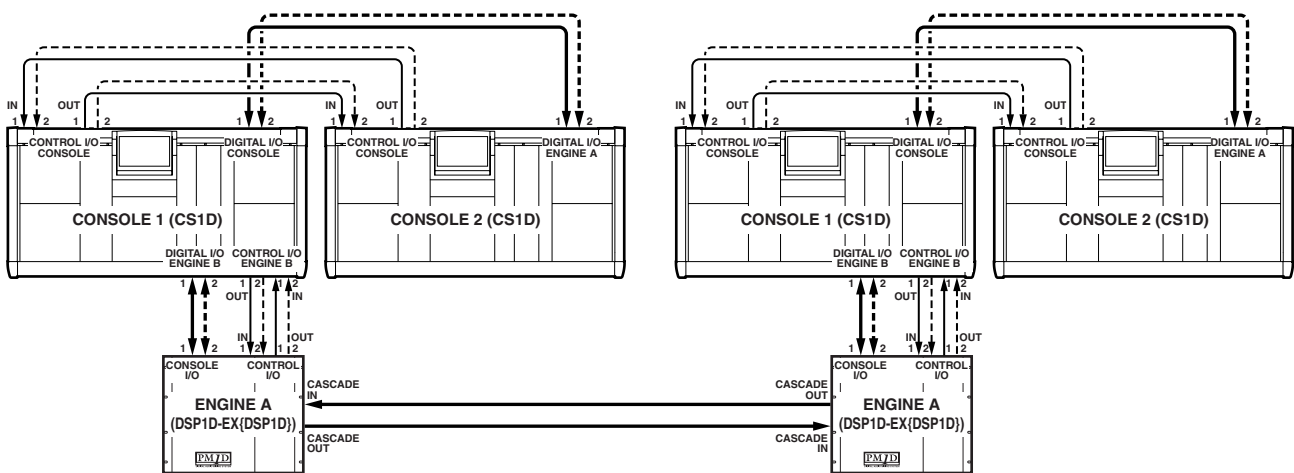

- The dashed lines in the above diagram are spare connections for use in the event that the currently-valid connectors become unusable.
- The system will operate normally even with just the connections shown by the solid lines. However, **we recommend that you also make the spare connections** shown above whenever possible.



CASCADE IN connectors must be connected to CASCADE OUT connectors, and vice versa. The system will not operate if two IN connectors or two OUT connectors are connected, or if only one is connected.

## Establishing a cascade connection

Here's how to designate one system as the "master" and the other system as the "slave," and establish a cascade connection.

- ⚠ In order to use cascade connection, one system must be designated as the master and the other as the slave. If both are designated as the master (or slave), they will not operate correctly.
- In cascade connection, both systems have equal status. You may specify either one as the master.

**1. Power-on the devices in the order of input/output units, engines, and console power supplies.**

- ⚠ Incorrect operation while making settings can cause a high-volume signal to be output. We strongly recommend that you turn down the volume of your power amps until connections are completed.

**2. On one system, access the SYS/W.CLOCK function CASCADE screen (newly added in version 1.5).**

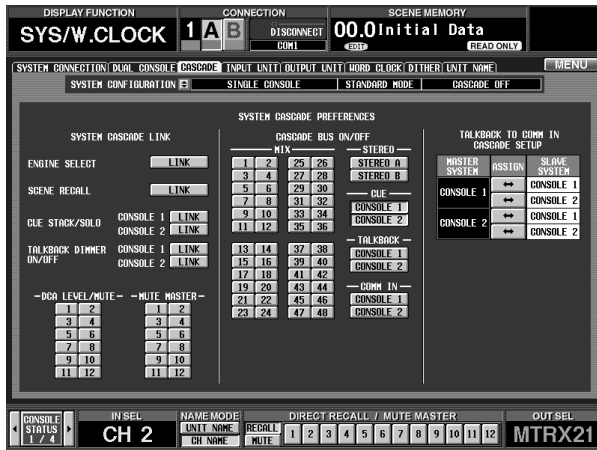

- ⚠ When cascading Dual Console mode systems, you must perform the following operations on console 1 of each system. The settings of the CASCADE screen cannot be edited from console 2.

**3. In the SYSTEM CONFIGURATION field, click the button.**

The SYSTEM CONFIGURATION popup window will appear. In the CASCADE MODE SELECT section of this window, you can turn cascade connection on/off and designate the master/slave systems.

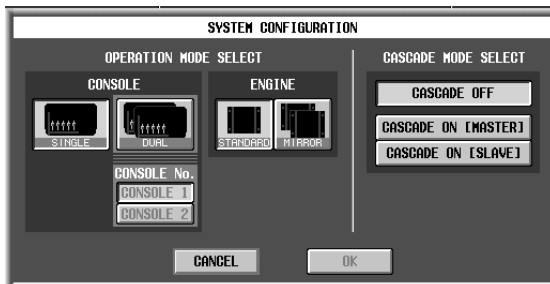

**4. In the CASCADE MODE SELECT section, click the CASCADE ON [MASTER] button, and then click the OK button.**

This system will be designated as the cascade connection master. At this time, the console number will begin blinking in the CONNECTION field at the top of the screen. This blink indicates that cascade-connection was specified, but the other system has not yet been found.



**5. On the other system, access the SYSTEM CONFIGURATION popup window in the same way.**

**6. In the CASCADE MODE SELECT section, click the CASCADE ON [SLAVE] button, and then click the OK button.**

This system will be designated as the cascade connection slave. Now both systems will attempt to establish a cascade connection. When the connection has been established, the console number that had been blinking in the CONNECTION field at the top of the screen will change from blinking to steadily lit.

- ⚠ In order to use cascade connection, all consoles, engines, and PM1D Manager in both systems must have the identical software version. If the versions differ, the version check popup window will appear, and you will be unable to use cascade connection.



As long as a cascade connection exists, the CASCADE screen settings of both systems will always be linked. If the settings of this screen differ when the systems are first connected, the settings of the master will be copied to the slave.

**7. In the CASCADE screen, use the buttons of the CASCADE BUS ON/OFF section to select the buses/signals that will be cascade-connected.**

The following buses/signals can be selected.

- MIX .....MIX buses 1–48
- STEREO .....STEREO buses A/B
- CUE .....CUE bus of console 1 or 2
- TALKBACK .....Talkback signal of console 1 or 2
- COMM IN.....COMM IN signal of console 1 or 2

For example if you select the MIX 1 button, the MIX bus 1 pre-fader signal will be sent from one engine to the other engine, and will be mixed with the MIX bus 1 pre-fader signal of the other engine. In the same way, the pre-fader signal of MIX bus 1 pre-fader signal of the other engine will be sent to the first engine, and mixed with the MIX bus 1 pre-fader signal.

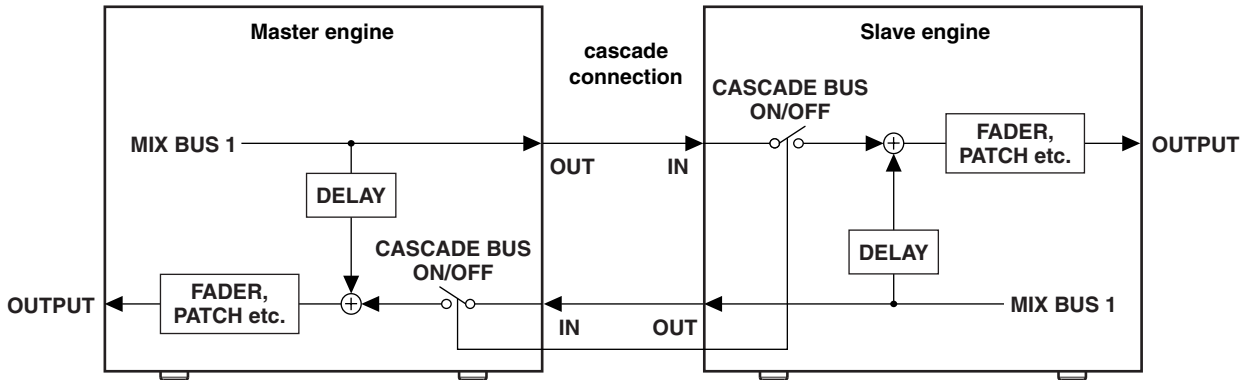

In order to compensate for phase differences of the input signal when the MIX bus, STEREO bus, and CUE bus are cascade-connected, the corresponding bus outputs will be delayed by two samples (for the MIX buses / STEREO buses) or three samples (for the CUE bus) more than the previous version. These signals will always be delayed even if cascade is turned off.

When cascade-connecting the CUE bus, talkback, and COMM IN, you can make these selections independently for console 1 and 2. (Console 2 is valid only in Dual Console mode.) For example if the CONSOLE 1 button in the CUE area is turned on, the console 1 CUE bus signal will be cascade-connected between the two systems.

If cascade-connection is enabled for the talkback signal, talkback on/off operations will also be linked between the two systems.

8. To cancel cascade connection, access the SYSTEM CONFIGURATION popup window, and click the CASCADE OFF button of the CASCADE MODE SELECT section.



## Cautions when using cascade connection

This section explains points that you should keep in mind when using cascade connection.

### ■ Checking the CASCADE IN/OUT connectors

If cascade connection is not established even after you have connected the CASCADE IN/OUT connectors between the two systems and designated one as the master and the other as the slave, access the SYSTEM CONNECTION screen. In this screen, the CASCADE IN/OUT connector symbols will indicate the state of connections.

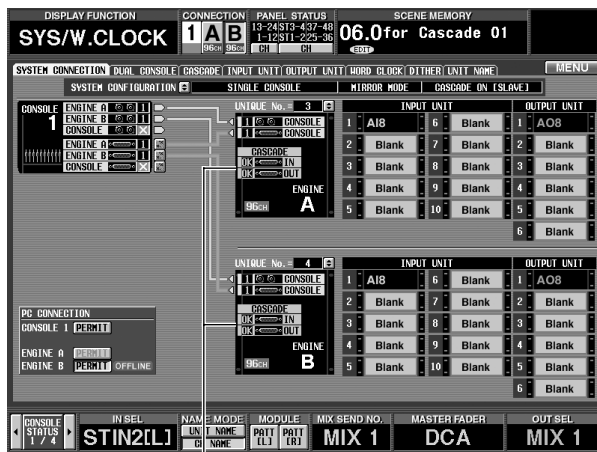

CASCADE IN/OUT connector

Each symbol has the following meaning.

- **X**..... There is a problem with the physical connection. Check that the cable is not broken, and that it is not connected between two CASCADE IN connectors or two CASCADE OUT connectors.
- **OK (gray)**..... The physical connection exists, but communication has not been established between the two systems. Check that you have not designated both systems as the master or both as the slave, and make sure that the system version is the same for all units.
- **OK (green)**..... Communication has been established between the two systems. Make sure that the buses and signals that you want to cascade-connect are selected.

### ■ Linking engine A/B selection

If PM1D systems in Mirror mode are cascade-connected, selection of engines A/B can normally be performed independently by each system. The other system will not be affected in any way, including its screen display.

If the ENGINE SELECT LINK button is turned on in the CASCADE screen, switching the engine on one system will cause a confirmation popup window to appear only on that system. When you execute the switch, the other system will also be switched forcibly.

If the engine is switched automatically, due to problems with the engine or some other reason, the engine of the other system will also be forcibly switched without a warning being issued.

### ■ Linking scene store/recall operations

If the SCENE RECALL LINK button is turned on in the CASCADE screen, performing a scene memory store/recall operation on one system will cause only that number and a store/recall command to be transmitted to the other console.

If the scene number specified as the recall source is empty on the other system, the recall command will be ignored.

### ■ Linking cue operations

By using the CONSOLE 1 / CONSOLE 2 buttons in the CUE section of the CASCADE screen, you can cascade-connect the CUE buses between the console 1 units or between the console 2 units of the two systems.

In this case, cue operations of the two systems will not be linked, so when cue is turned on by the other console, the cue signal of the other console cannot be monitored from MONITOR OUT jacks A unless you manually turn cue on for your own console as well.

Thus, you can use the CUE STACK/SOLO section of the CASCADE screen to link cue operations and solo operations between consoles 1 or consoles 2 of the master and slave systems. When the LINK button is on, the following items will be linked between the corresponding consoles.

- **Cue mode**  
CUE/SOLO switches and LAST CUE/MIX CUE switching will be linked.
- **Cue interrupt**  
When cue/solo is turned on by either system, the monitoring source for MONITOR OUT jacks A on both systems will switch to the CUE bus. (This lets you monitor the cue/solo signal.)
- **PFL/AFL and PRE PAN/POST PAN switching of input channels**
- **PFL/POST ON switching of output channels**

- **DCA PRE PAN on/off switching**
- **Cue stack**

The cue status will be monitored across both systems, and the last-selected of the four CUE groups (INPUT CUE, DCA CUE, OUTPUT CUE, other) will be enabled for both systems. For example when output channel cue is enabled, pressing the DCA group [CUE] switch on either system will enable the DCA group on both systems.



- Cue interrupt is linked only if CUE INTERRUPTION is turned on in the CUE/SOLO screen of both systems.
- For a detailed explanation of CUE group operation, refer to “CS1D Reference Manual (Hardware),” p.81.

### ■ Linking talkback

By using the CONSOLE 1 / CONSOLE 2 buttons in the TALKBACK section of the CASCADE screen, you can cascade-connect the talkback signals between the console 1 units or between the console 2 units of the two systems.

In this case, talkback on/off operations will also be linked between the two systems. If you turn on talkback for one system, the talkback signal will be sent to the bus or connector selected on that system, and the same signal will also be sent to the bus or connector that is selected on the other system.

If you also want to link the dimmer operation that occurs when you turn on talkback, use the CONSOLE 1 / CONSOLE 2 buttons in the TALKBACK DIMMER ON/OFF section of the CASCADE screen.

### ■ Linking DCA groups

You can use the DCA LEVEL/MUTE buttons (1–12) in the CASCADE screen to link the level and mute on/off state of the desired DCA group.



When you turn on the button for the DCA group that you want to link, the level and mute status of that DCA group will be copied from the

master to the slave. (At this time it does not matter whether the channels belonging to the DCA groups match.)

Subsequently, changes made by one system to the level or mute on/off status of the corresponding DCA group will be reflected in the other system.

If a scene recall on one system causes the DCA level or mute status to no longer match, the level and mute status settings of the system that recalled the scene will be copied to the other system.

While the DCA LEVEL/MUTE button is on, the fade time setting of that DCA group will be ignored, and you will be unable to use auto fading and manual fading.

If the DCA LEVEL/MUTE button is turned on while LINK CUE STACK/SOLO is on, DCA cue will also be linked between the two systems. However, if the DCA assignment location (input channel or output channel) differs between the two systems, cue will not be linked. If, while cue is being used, the DCA assignment location of one system changes due to either scene recall or manual operation, cue will be defeated for the DCA that changed.

### ■ Linking mute groups

You can use the MUTE MASTER buttons (1–12) in the CASCADE screen to link mute on/off operations of the desired mute group.



When you turn on the button for the mute group that you want to link, mute on/off operations for the corresponding mute group performed on one system will be reflected in the other system.

### ■ Sending the master talkback signal to the slave COMM IN

The talkback signal of the master system can be supplied to console 1/2 of the slave system as a COMM IN signal. For example, this is convenient when you want to unidirectionally send the talkback signal from the master system to the slave system rather than cascading the talkback signal.

To do so, you will use the TALKBACK COMM IN CASCADE SETUP section of the CASCADE screen.

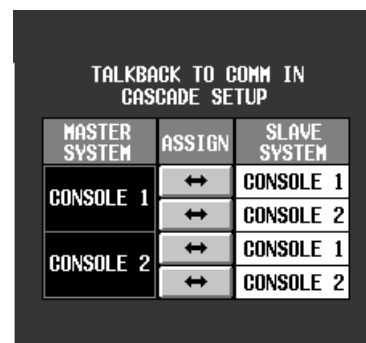

Assignments can be made independently for console 1 and 2 of the master system and console 1 and 2 of the slave system.

Talkback signals will be sent between the assigned consoles to the COMM IN of the other unit.

## Using GPI (General Purpose Interface)

PM1D system software V1.5 allows you to use GPI (General Purpose Interface).

The PM1D system engine (DSP1D-EX{DSP1D}) and console (CS1D) have a D-sub 25-pin GPI (General Purpose Interface) connector. This GPI connector combines both GPI IN and GPI OUT, and allows eight channels of control signal to be input and output simultaneously for communication with an external device. For the pin configuration, refer to page 69 of the CS1D Reference manual (Appendices).

**!** The GPI OUT connector is an open collector output. Also GPI IN is pulled-up at 5 V. The power supply pins must be used at less than MAX 160 mA, and the GPI IN/OUT pins at less than MAX 40 mA.

The following diagram is an example of using GPI to create external switches and indicators for them.

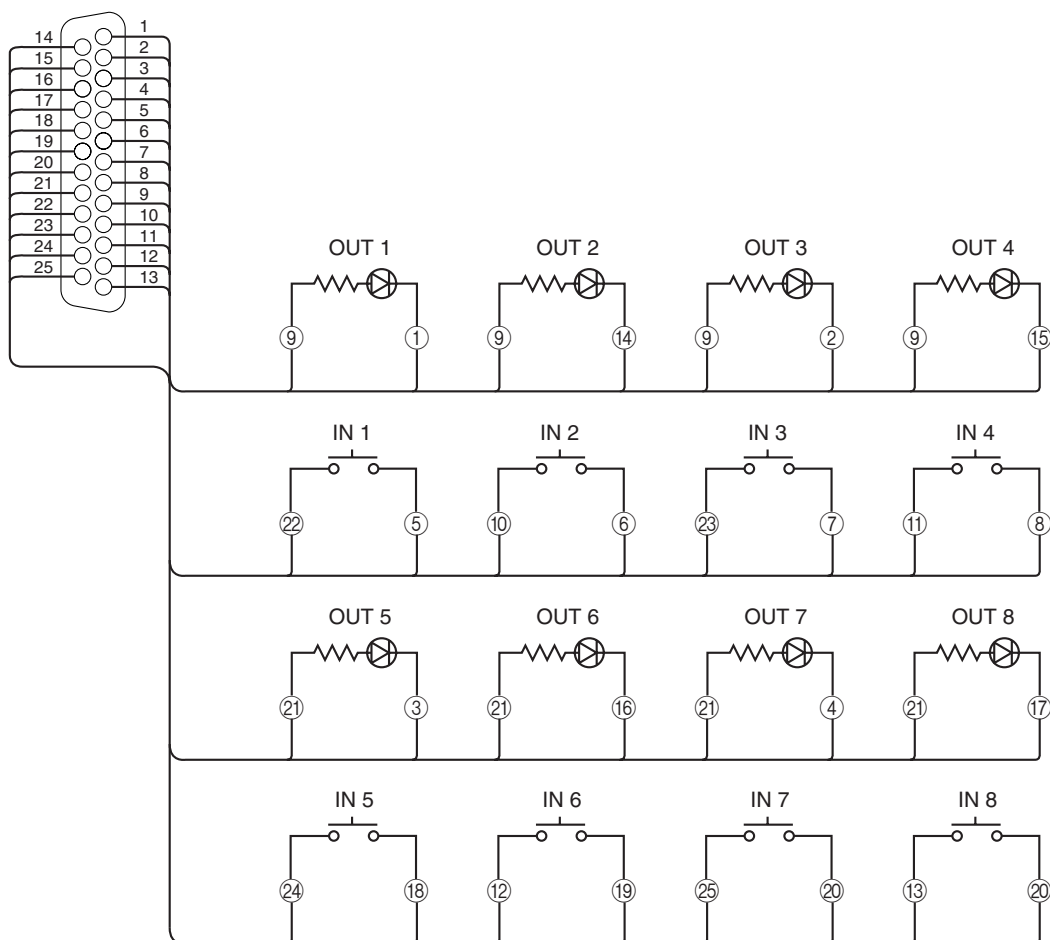

You are free to specify how the PM1D system will operate when control signals are received from GPI IN, and which operations on the PM1D system will cause control signals to be transmitted from GPI OUT.

By connecting a GPI-compatible external device or a customized external switch etc. to the GPI connector, you can cause an external device to start running when a fader is operated, or use an external device to remotely control talkback operations or select monitor sources.

- !** When using the PM1D system in Mirror mode, only the currently selected engine can use its GPI IN connector. Also, the output from the GPI OUT connector is always linked for engines A and B.
- When using the PM1D system in Dual Console mode (→p.11), only the currently-operated console can use its GPI connector. You cannot change the settings of the other GPI connector, or receive control signals from the other GPI connector. Also, settings for the GPI connector of the engine can be made only on console 1.

## GPI screen

A GPI screen allowing you to make GPI IN/OUT settings has been added to the MIDI/GPI/TC function.

### ■ GPI IN

INPUT PORT	TRIGGER	FUNCTION	PARAMETER
CONSOLE 1 PORT 3	H	USER DEFINE LED [TALLY IN]	LED No. = 8
CONSOLE 1 PORT 4	H	ENGINE B SELECT	
CONSOLE 1 PORT 5	H	RIGHT SIDE PANEL FLIP	FLIP TYPE = MODULE FLIP
CONSOLE 1 PORT 6	H	INPUT/DCA ON	DCA No. = 12
CONSOLE 1 PORT 7	H	INPUT/DCA ON	CH No. = CH25
CONSOLE 1 PORT 8	H	USER DEFINE LED [TALLY IN]	LED No. = 8
ENGINE PORT 1	H	TAP TEMPO	
ENGINE PORT 2	H	BOOKMARK	[IN PATCH] INPUT PATCH

- ① **INPUT PORT**  
Selects the GPI IN port for which you will make settings. You can select console ports 1–8 or engine ports 1–8.
- ② **GPI IN status**  
Indicates the input signal status for the corresponding port. The characters L/H indicate whether the signal level is low (switch is grounded) or high (high-level signal is input). The background color will be

yellow when active, or gray when inactive. The TRIGGER (③) field selects whether signal high or low will be the active state.

### ③ TRIGGER

Selects the GPI IN on/off detection method. You can choose either Low Active (active when switch is grounded) or High Active (active when high-level signal is input, or when open).

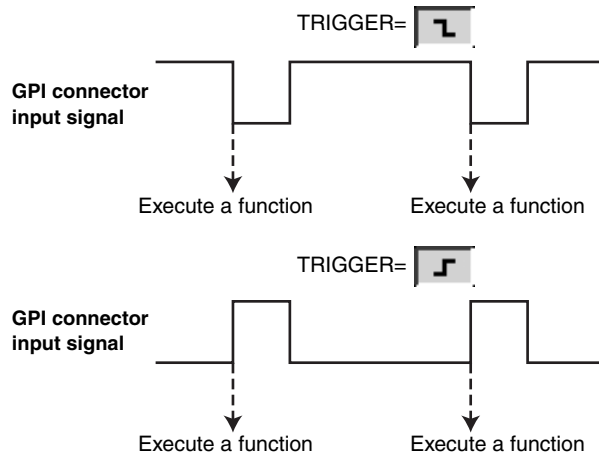

### ④ ASSIGN button

Clicking this button displays the GPI IN SETUP popup window, where you can assign a function to each GPI IN port.

### ⑤ FUNCTION

Indicates the name of the function assigned in (④).

### ⑥ PARAMETER

Indicates any optional parameters for the function assigned in (④).

You can select the following functions and their parameters for GPI IN. (Parameters specific to each function are enclosed in parentheses.)

- **NO ASSIGN**  
No assignment
- **SCENE MEM INC/DEC RECALL (RECALL TYPE: INC/DEC)**  
Recall the scene that follows (or precedes) the currently selected scene.
- **MONITOR SOURCE SELECT (2TR IN 3-6, DIRECT, MIX 1-48, MATRIX 1-24, A/B SELECT)**  
Select the source to be monitored. Use A/B SELECT to select MONITOR A or B, and use the remaining buttons to preset up to four monitor sources.
- **PAGE SELECT (SELECT TYPE: LAST, PREVIOUS, NEXT)**  
Show the desired screen in the display. As parameters, you can choose LAST (the last-selected screen), PREVIOUS (the preceding screen within the same function), or NEXT (the next screen within the same function).
- **BOOKMARK**  
Recalls the last-registered screen. To register a screen, recall the desired screen and press and hold the corresponding external switch for two seconds or longer. If the lower part of the screen displays the console/engine GPI IN test button (→p.10), the corresponding switch will show the text “BOOKMARK” and the title of the registered screen.

- **MANUAL FADE ON (TRIGGER TYPE: AUTO/MANUAL, MANUAL ONLY)**

Switch manual fading. If AUTO/MANUAL is selected as the parameter, the system will switch between auto fading and manual fading each time a trigger is received.

If MANUAL ONLY is selected, manual fading will be enabled if the trigger is received even once.

In either case, enabling manual fading will recall the FADE TIME screen, and the cursor will move to the PROGRESS knob. In this state, you can turn the [DATA] encoder to immediately control manual fading.

- **MUTE MASTER/DIRECT RECALL (TRIGGER TYPE: LATCH, UNLATCH)**

Select whether the SCENE MEMORY [1]–[12] switches on the console front panel will directly recall the twelve pre-assigned scenes, or whether they will act as on/off switches for mute groups 1–12. (This is the same function as the DIRECT RECALL screen MODE button.) As the switch operation, you can choose either Latch (change each time the switch is pressed) or Unlatch (direct recall is enabled only while the switch remains pressed).

- **NAME MODE CH/UNIT (TRIGGER TYPE: LATCH, UNLATCH)**

Select whether the display will show the short name of the input channel or the unit name assigned to that input channel. This is the same function as the NAME MODE button (→p.8) shown in the lower part of the screen. As the switch operation, you can choose either Latch (change each time the switch is pressed) or Unlatch (unit name is shown only while the switch remains pressed).

- **RIGHT SIDE PANEL FLIP (FLIP TYPE: MODULE FLIP, FADER FLIP)**

Perform the Flip operation for INPUT blocks 3/4 located in the right side of the console. If MODULE FLIP is selected, INPUT blocks 3 and 4 will be exchanged. If FADER FLIP is selected, the faders and [MIX] encoders will be exchanged.

⚠ If you want to independently perform module flip for the left and right INPUT blocks, go to the PANEL ASSIGN screen (a new screen added in V1.5) and turn off the MODULE FLIP / PATTERN CHANGE LINK button. If you want to independently perform fader flip for the left and right INPUT blocks, you must turn off the FADER FLIP LINK button in the same screen.

- **TRACKING RECALL (KEY ASSIGN: ENABLE, OFFSET LOCK)**

Operate the Tracking Recall function. If ENABLE is selected, tracking recall will be switched between enabled/disabled. If OFFSET LOCK is selected, the offset value will be locked/unlocked.

- **MMC TRANSPORT (MIDI PORT, MMC ID, TRANSPORT)**

Transmit an MMC transport command to the specified MIDI port. As parameters, you can specify the destination MIDI port (console or engine), the

MMC ID (1–127, ALL), and the type of transport command (<<REW, FF>>, STOP, PLAY>).

Since this is open-loop, the status of the other device is not monitored.

- **MMC LOCATE (MIDI PORT, MMC ID, FRAME, TIME CODE)**

To the specified MIDI port, transmit an MMC locate command for moving to the desired time code location. As parameters, you can specify the destination MIDI port (console or engine), the MMC ID (1–127, ALL), the frame rate (24, 25, 29.97, 30), and the time code (hours/minutes/seconds/frames).

- **REMOTE [RS422] TRANSPORT (RS422 PORT, FORMAT, TRANSPORT)**

Send a transport command to the specified RS422 connector. As parameters, you can specify the destination RS422 port (console or engine), the command format (P2 or DENON), and the type of transport command. (In P2 format<sup>1</sup>, the transport commands are <<REW, FF>>, STOP, PLAY>. In DENON format<sup>2</sup>, the transport commands are <<PREV, NEXT>>, STANDBY, PLAY>.)

 Only one REMOTE [RS422] command format can be specified for each component.

- **REMOTE [RS422] LOCATE (RS422 PORT, FORMAT, TIME CODE)**

Send a locate command to the specified RS422 connector. As parameters, you can specify the destination RS422 port (console or engine), the command format (P2 or DENON), and the time code (hours/minutes/seconds/frames). For DENON format, this will operate as follows.

- You can also specify the TRACK number.
- TRACK 0 is valid only for CD.
- Frame can be up to 74, but will be changed to up to 86 frames by the MD device.

 Only one REMOTE [RS422] command format can be specified for each component.

- **GPI TRANSPORT (GPI PORT, PORT, TRANSPORT)**

Send a control signal to the specified port of GPI OUT. As parameters, you can specify the output destination GPI port (console or engine), the GPI OUT port number (1–8), and the name (<<REW, FF>>, STOP, PLAY) that will be displayed at the bottom of the screen.

 The TRANSPORT parameter you specify here is used to select the function name (→p.10) when the GPI IN test button for the console/engine is displayed in the lower part of the screen. Please be aware that regardless of the name that is selected, the control signal that is actually output will not change at all.

- **GPI OUT CONTROL (GPI PORT, PORT)**

To the specified GPI OUT port, send a control signal that is identical to the GPI IN on/off state. As parameters, you can specify the destination GPI port (console or engine), and the GPI OUT port number (1–8).

- **TAP TEMPO**

You can manually set the TEMPO parameter of an internal effect by repeatedly pressing an external switch connected to GPI IN at the desired tempo (→p.51).

- **TB ON (TRIGGER TYPE: LATCH, UNLATCH)**

Talkback can be switched on/off by operating an external switch connected to GPI IN. As the operating mode of the switch, you can choose either Latch (change each time the switch is pressed) or Unlatch (talkback is on only while the switch remains pressed).

- **USER DEFINE LED [TALLY IN] (LED No.)**

GPI IN on/off can be used to switch the console's USER DEFINE switch LEDs between lit/dark. The LED No. parameter selects the switch number (1–8). When the list of USER DEFINE functions is displayed at the bottom of the screen, the buttons in the screen will also switch between lit/dark in tandem with this.



The console's USER DEFINE LEDs can be used as indicators. For example if the external device has a TALLY output function that can indicate the state of the device itself, you can assign GPI TRANSPORT or MMC TRANSPORT to USER DEFINE, so that the USER DEFINE LED will light or go dark according to the state.

- **INPUT/DCA ON (ASSIGN TYPE, CH No.)**

Switch a specified input channel or a specified DCA on/off. Use the ASSIGN TYPE parameter to select either INPUT or DCA, and the CH No. parameter to specify the channel.

- **ENGINE B SELECT**

When using the PM1D system in Mirror mode, switch to engine B if possible.



By connecting a signal line from an uninterruptible power supply etc. to GPI IN, you can construct a system that automatically switches to engine B when a power failure occurs.

1. P2 format is a command format used by the Yamaha D24, Tascam DA-98HR, and various professional video equipment.  
 2. DENON format is a command format used by Denon professional CD (DN-C680) and MD (DN-M1050R) devices. Set the CD or MD to 9600 bps / RS422. In the case of DENON, pressing PLAY while already playing will select PAUSE mode, and pressing STANDBY while already standing-by will select STOP mode. If you want to change from STOP to STANDBY, press NEXT. Use a D-sub 9-pin straight cable to connect the REMOTE RS422 connector to the device being controlled in P2 or DENON format.

## ■ GPI OUT

GPI OUT		①	②	③	④	⑤	⑥	⑦	⑧
CONSOLE	PORT	STATUS	FUNCTION	POLARITY	TEST	ASSIGNED TRIGGER	PARAMETER		
CONSOLE 1	PORT 1	H	TALLY	⌋	⬅	GPI IN FUNCTION	[CONSOLE 1] PORT 1		
CONSOLE 1	PORT 2	H	TRIGGER	⌋	⬅				
CONSOLE 1	PORT 3	H	TRIGGER	⌋	⬅	FADER START	[START] CH27		
CONSOLE 1	PORT 4	H	TRIGGER	⌋	⬅	FADER START	[END] CH27		
CONSOLE 1	PORT 5	H	TALLY	⌋	⬅	PREVIEW ON/OFF			
CONSOLE 1	PORT 6	H	TALLY	⌋	⬅	CUE ON/OFF			
CONSOLE 1	PORT 7	H	TALLY	⌋	⬅	CUE ON/OFF [OUTPUT ONLY]			
CONSOLE 1	PORT 8	H	TRIGGER	⌋	⬅	FADER START	[START] CH 5 ...		

### ① OUTPUT PORT

Selects the GPI OUT port for which you will make settings. You can select control ports 1–8 or engine ports 1–8.

### ② GPI OUT status

Indicates the output signal status of the corresponding port. The character L or H indicates whether the signal level is low (switch is grounded) or high (open). The background color will be yellow when active, and gray when inactive. Use the POLARITY (④) field to specify whether a low level or a high level signal will be output for the Active state.

### ③ TALLY/TRIGGER/TOGGLE

Indicates the transmission method for the signal that is output from GPI OUT. If the function of the port has been set by the DIRECT ASSIGN button (⑥), this will indicate TALLY, and it will not be possible to switch it on/off. In this case, the active/inactive state of the item selected by ASSIGNED TRIGGER (⑦) will be detected, and the tally signal will be sent to the corresponding GPI OUT port only while active.

The following diagram show an example of transmitting a tally signal from the GPI OUT port in correspondence to on/off operations of a specified [CUE] switch.

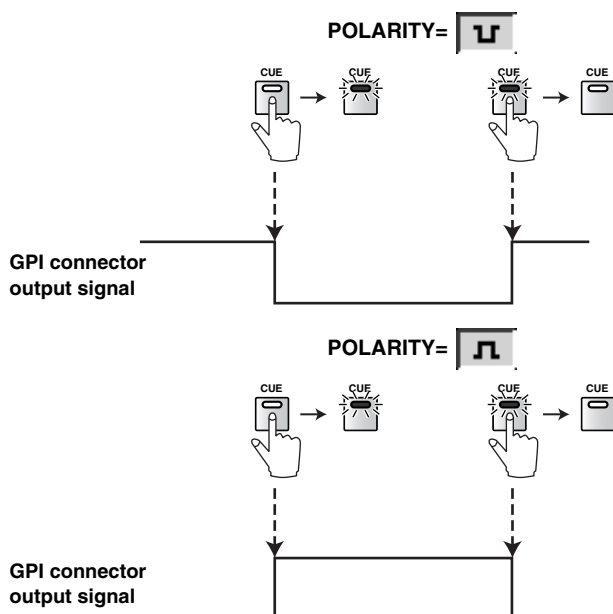

If GPI TRANSPORT or GPI OUT CONTROL is selected as the function assigned to USER DEFINE or GPI IN, or if GPI is selected as the fader start output destination, a button to switch between TRIGGER and TOGGLE will be displayed here. (For details on operation →p.49 to 50).

⚠ If you want to control GPI OUT from USER DEFINE, make settings in the UTILITY function USER DEFINE screen. If you want to control it from GPI IN, make settings in the GPI IN display field (→p.36). If you want to control it by fader start, make sure that in the MIDI/GPI/TC function FADER START screen (→p.43).

### ④ POLARITY

Selects the polarity of the signal that is output from the corresponding port. You can select Low (grounded when active) or High (open when active).

### ⑤ TEST

These buttons let you test the GPI OUT ports. Each time you click one of these buttons, a control signal will be output to GPI OUT according to the TALLY/TRIGGER/TOGGLE (③) and POLARITY (④) settings, just as though a trigger had occurred.

### ⑥ DIRECT ASSIGN button

Clicking this button will open the GPI OUT SETUP popup window, where you can directly specify the type of trigger that will control the signal output for each GPI port.

In the GPI OUT SETUP popup window you can select the following items.

- **NO ASSIGN**  
No assignment.
- **GPI IN FUNCTION**

A control signal will be output according to the state of the function that is assigned to the identical port and port number of GPI IN. If you select this trigger, the PARAMETER (⑧) field will indicate the type of GPI IN port (CONSOLE or ENGINE) and the port number (1–8).

If an external switch is connected to GPI IN, GPI OUT can be used as an indicator for that switch.

• **PREVIEW ON/OFF**

Transmit a control signal when PREVIEW mode is turned on in the SCENE MEMORY block of the console.

• **CUE ON/OFF**

Transmit a control signal when the DCA [CUE] switch of a specified input channel or output channel, the EFFECT CUE of a specified internal effect, or the KEY IN CUE or SUB IN CUE of a specified gate turns on.

• **CUE ON/OFF [INPUT ONLY]**

Transmit a control signal when the [CUE] switch of a specified input channel turns on.

• **CUE ON/OFF [DCA ONLY]**

Transmit a control signal when the [CUE] switch of a specified DCA turns on.

• **CUE ON/OFF [OUTPUT ONLY]**

Transmit a control signal when the [CUE] switch of a specified output channel turns on.

⑦ **ASSIGNED TRIGGER**

Indicates the type of trigger that is assigned in ⑥.

⑧ **PARAMETER**

Displays more detailed information according to the type of trigger assigned in ⑥.



There are four ways to specify a trigger for GPI OUT, as follows.

- In the USER DEFINE screen (UTILITY function), specify GPI TRANSPORT and GPI OUT CONTROL
- Specify GPI TRANSPORT and GPI OUT CONTROL as the GPI IN function
- In the FADER START screen (MIDI/GPI/TC function), specify GPI as the output destination
- Use the DIRECT ASSIGN button (⑥) to directly specify the trigger.



It is not possible to simultaneously specify different types of trigger for the same GPI OUT port. If you attempt to make conflicting settings, the lower part of the screen will indicate “GPI OUT SETUP IN USE WAS STOLEN.” and the previous setting will be lost.

Conversely, you may simultaneously specify more than one trigger of the same type, for example by assigning a GPI OUT CONTROL function from more than one GPI IN to the same GPI OUT. In this case, fields ⑦ and ⑧ will show “...” to indicate that more than one trigger is assigned. However, even if more than one trigger is assigned, only the most recent trigger will be responded to.

## Using GPI IN

Here’s how to send a control signal from an external device to GPI IN and remotely control the operation of the PM1D system.

1. **Connect a GPI compatible external device or external switch to the GPI connector of the engine or console.**



- If you are using the PM1D system in Mirror mode, only the GPI IN connector of the currently selected engine can be used.
- If you are using the PM1D system in Dual Console mode (→p.11), only the GPI connector of the currently-operated console can be used. It is not possible to change the GPI connector settings of the other unit, or to receive control signals from the GPI connector of the other unit. Furthermore, settings for the GPI connector of the engine can be made only from console 1.

2. **Access the MIDI/GPI/TC function GPI screen.**
3. **Scroll the GPI IN list to show the INPUT port that you want to set.**
4. **According to the character of the signal that is sent from the external device / external switch, set the TRIGGER field to Low Active (active when switch is grounded) or High Active (active when a high-level signal is input, or when open).**

5. **At the left of the FUNCTION field, click the DIRECT ASSIGN button  to access the GPI IN SETUP popup window.**

In the GPI IN SETUP popup window, the INPUT PORT field at the upper left shows the type (CONSOLE/ENGINE) of the currently selected port, and the port number (GPI1–GPI8).

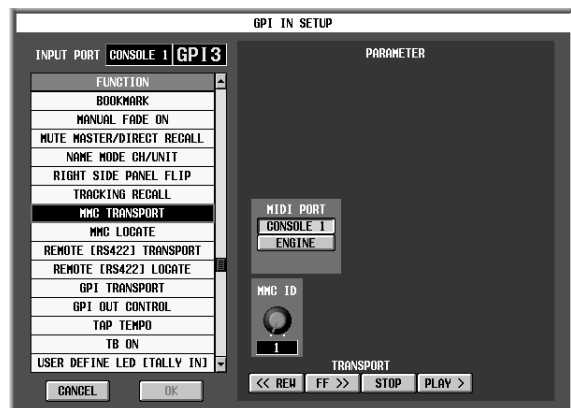

6. **Scroll the list in the left part of the screen, and click the function that you want to assign.**  
The PARAMETER field will show the parameters that are specific for that function.



7. As necessary, use the **PARAMETER** field located at the right to specify the parameters, and click the **OK** button.

The popup window will close.

8. In the same way, make other **GPI IN** settings as desired.



By displaying **GPI IN CONSOLE / GPI IN ENGINE** in the lower part of the screen, you can check the function that is assigned to each port (→p.10).

9. Operate the external device / external switch to send a control signal to the **PM1D** system.

The function that is assigned to that **GPI IN** port will be executed on the **PM1D** system.



Of the functions that can be assigned to **GPI IN**, Tap Tempo is explained in detail on page 51, so you may refer to that section as well.

## Using GPI OUT

Here's how you can remotely control an external device by sending control signals from **GPI OUT** when a specific operation is performed on the **PM1D** system.

1. Connect your **GPI** compatible external device to the **GPI** connector of the engine or console.



- If you are using the **PM1D** system in Mirror mode, **GPI OUT** output always operates in tandem for engines A and B.
- If you are using the **PM1D** system in Dual Console mode (→p.11), only the **GPI** connector of the currently-operated console can be used. It is not possible to modify the settings for the **GPI** connector of the other unit, or to receive control signals from the **GPI** connector of the other unit. Furthermore, settings for the **GPI** connector of the engine can be made only from console 1.

2. Access the **MIDI/GPI/TC** function **GPI** screen.
3. Scroll the **GPI OUT** list to display the **OUTPUT** port that you want to set.
4. According to the character of the signal that your external device is able to receive, set the **POLARITY** field to either **Low** (grounded when active) or **High** (open when active).
5. At the left of the **ASSIGNED TRIGGER** field, click the **DIRECT ASSIGN** button  to open the **GPI OUT SETUP** popup window.

6. Scroll the list shown at the left side, click the trigger that you want to assign, and click the **OK** button.

The popup window will close.

7. In the same way, make other **GPI OUT** settings as desired.



You can use the **TEST** button in the **GPI** screen to test-transmit control signals from each **GPI OUT** according to the **POLARITY** and **TRIGGER/TOGGLE/TALLY** settings. This is a convenient way to verify that the external device will operate as you expect.

8. Execute the operation that is assigned to **GPI OUT**.

A control signal will be transmitted from the corresponding **GPI OUT** port.



If you want to use **GPI OUT** as a **USER DEFINE** destination, make settings in the **USER DEFINE** screen (→p.52). If you want to use **GPI OUT** as a destination from **GPI IN**, make settings in **GPI IN** (→p.36). Details on using this as a destination of **Fader Start** are given on page 42.

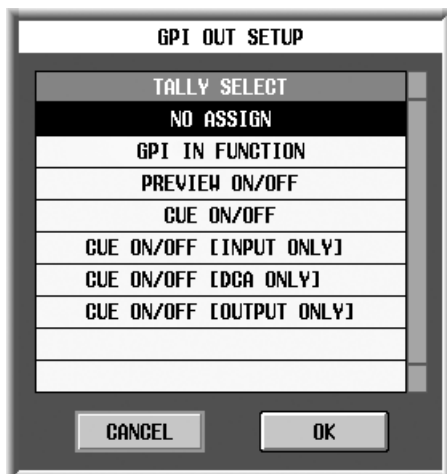

## Fader Start function

PM1D system software V1.5 provides a Fader Start function that can transmit control signals (GPI / MMC / RS422) to an external device when a specific fader is operated. For example, this is a convenient way by which an external device (such as a GPI-compatible CD player, RS422-compatible video player, or MIDI sequencer) located at a distance can be operated remotely.

To use this function, you need to assign the Fader Start function to the desired fader, and select the type of control signal (GPI / MMC / RS422) that you want to transmit.

A “Fader Start” trigger will occur when this fader is moved from below  $-60$  dB to above  $-60$  dB, and a “Fader End” trigger will occur when the fader is moved back to  $-\infty$ . When these triggers occur, the control signal you selected will be sent to the external device.

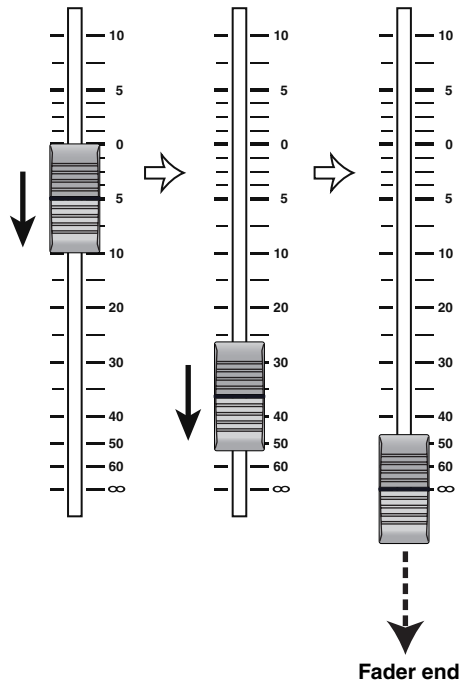
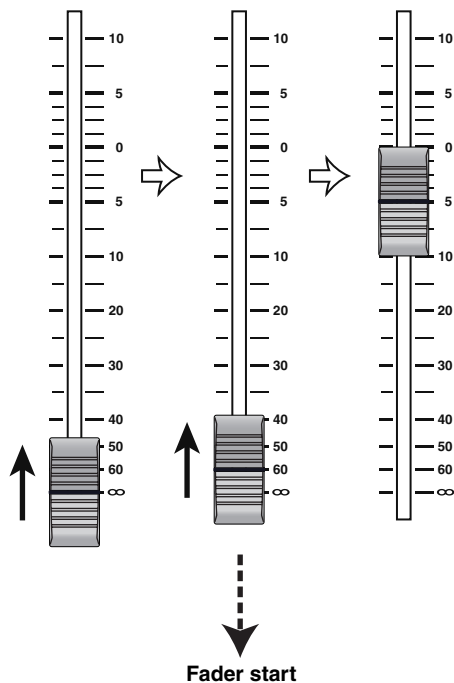

- ⚠ • If you want to generate a Fader Start trigger when the fader position is already above  $-60$  dB, move the fader below  $-60$  dB and then raise it once again.
- If CONSOLE 1 or ENGINE is selected as the output destination port, fader start will not work when you operate the fader (or edit the parameter via PC or MIDI) while console 1 is in PREVIEW mode. Similarly, if CONSOLE 2 is selected as the output destination port, fader start will not work while console 2 is in PREVIEW mode. Fader start will not work even if you cancel PREVIEW mode from the above states.
- If a PC (PM1D Manager) is connected on-line to the engine by itself, recalling a scene which specifies a fade time will cause Fader Start to operate immediately after the recall, regardless of the fade time setting.

## FADER START screen

A FADER START screen has been added to the MIDI/GPI/TC function, allowing you to make settings for the fader start function.

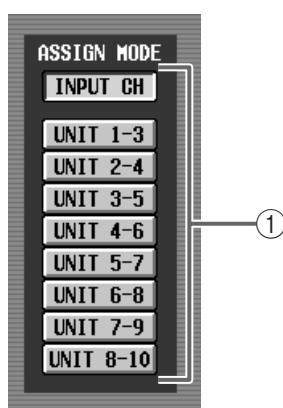
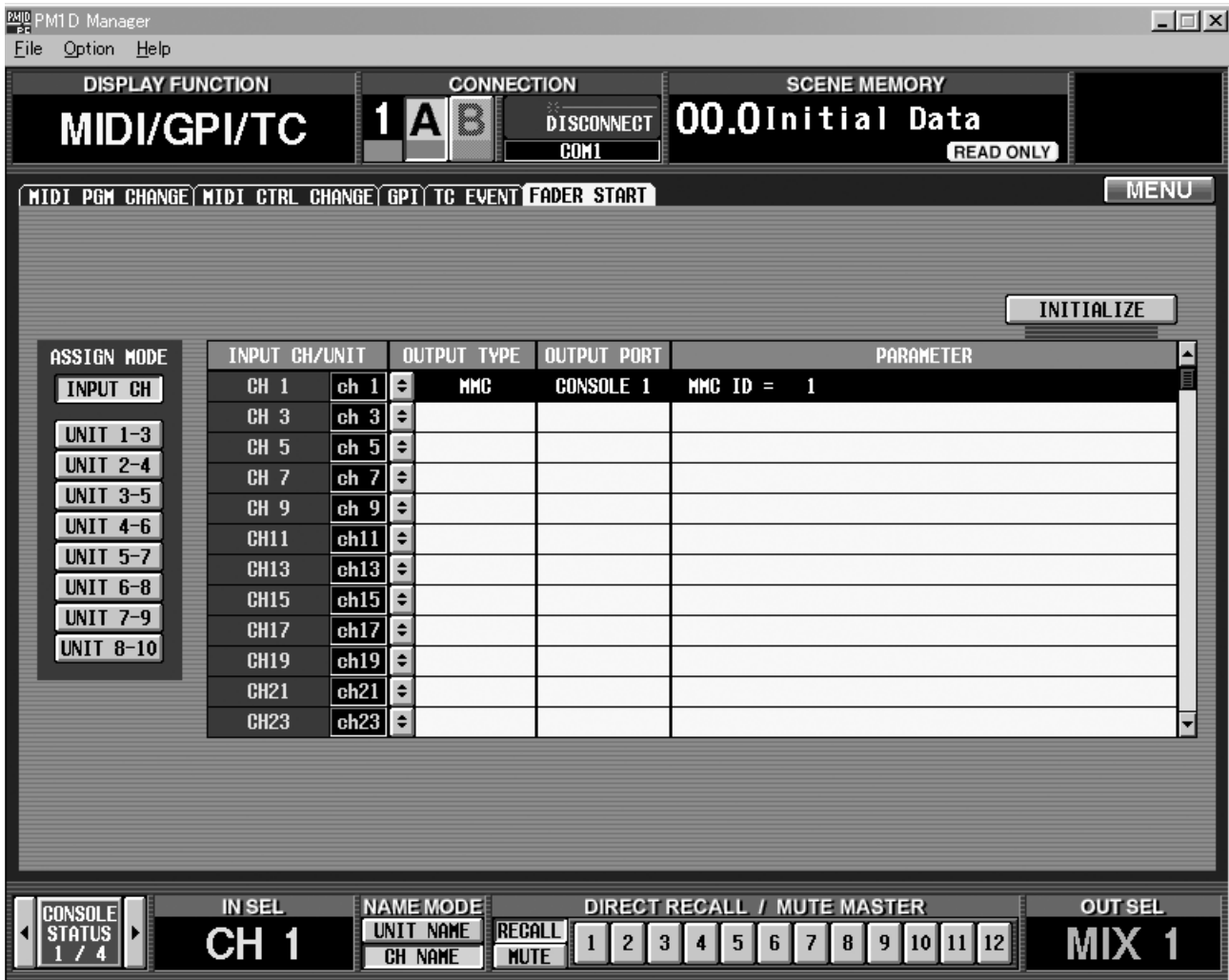

### ① ASSIGN MODE

Selects whether fader start assignments will be made for individual input channels or in groups of units. You can select one of the following buttons.

Click one of these buttons to open the FADER START INITIALIZE popup window, where you can initialize the fader start settings. To initialize, click the OK button.

### • INPUT CH

When this button is on, you can make fader start function assignments for individual input channels and ST IN channels.

### • UNIT 1-3 – UNIT 8-10

When one of these buttons are on, you can make fader start assignments for three input units of consecutive ID numbers. In this case, you can make assignments for the input channels assigned to each port of those units. (If multiple input channels are assigned to one port, the assignment will be valid only for the highest of those channels in the IN PATCH function INPUT PATCH screen.)



- In either case, please be aware that you cannot assign fader start to all channels and all ports.
- If the INPUT CH button is on, you can assign fader start to odd-numbered input channels (in vertical pair mode, channels 1–48) and the left channel of stereo input channels.
- If a UNIT 1-3 – UNIT 8-10 button is on, you can assign fader start only to an odd-numbered port of the available ports.

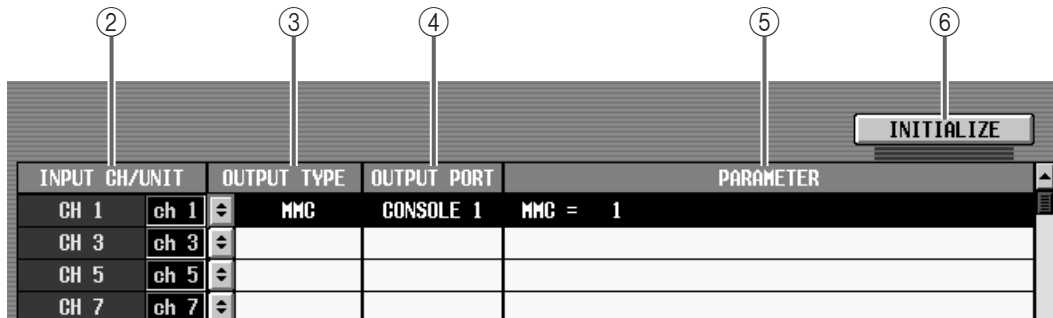

② **INPUT CH/UNIT (Input channel / unit)**

According to the selection for ASSIGN MODE (①), this will indicate the channel or unit/card/port for which you will make fader start assignments.

If the INPUT CH button is on, odd-numbered input channels (in vertical pair mode, channels 1–48) will be displayed.

If a UNIT 1-3 – UNIT 8-10 button is on, only the odd-numbered available ports will be displayed.

③ **OUTPUT TYPE**

Indicates the type of signal that will be output when you operate the fader of the corresponding input channel / unit. To change this assignment, click the button at left to open the FADER START SETUP popup window.

You can select the following items (parameters specific to that item are enclosed in parentheses).

- **NO ASSIGN**  
No assignment.
- **GPI (GPI PORT, START PORT, END PORT)**  
A control signal will be sent to the GPI connector. You can specify the GPI port (console 1/2, engine), start port (the port number that will output the signal when a fader start trigger is received), and end port (the port number that will output the signal when a fader end trigger is received).



If you specify the same GPI port as the start port and end port, and select TOGGLE in the MIDI/GPI/TC function GPI screen, fader start will cause GPI OUT to be in the Active state and fader end will cause it to be Inactive, allowing you to use fader start as Tally output.

• **MMC (MIDI PORT, MMC ID)**

An MMC command will be sent to the MIDI connector. You can specify the MIDI port (console 1/2, engine) and the MMC ID (1–127, ALL). A PLAY command will be sent when a fader start trigger occurs, and a STOP command will be sent when a fader end trigger occurs.

• **RS422 (RS422 PORT, FORMAT)**

An RS422 protocol transport command will be sent to the RS422 connector. You can specify the RS422 port (console 1/2, engine) and the format (P2, DENON). A PLAY command will be sent when a fader start trigger occurs, and a STOP command (if P2 format is selected) or PAUSE command (if DENON format is selected) will be sent when a fader end trigger occurs.

Only one type (P2 or DENON) can be selected as the REMOTE [RS422] command format for each component.

④ **OUTPUT PORT**

Indicates the port that will output the signal (console 1/2 or engine).

⑤ **PARAMETER**

According to the type of signal that is selected in (③), this area displays the optional parameter settings.

⑥ **INITIALIZE**

Click this button to open the FADER INITIALIZE popup window, where you can initialize the fader start settings. To initialize the settings, click the OK button.

## Using the Fader Start function

Here's how you can use the Fader Start function to remotely control an external device connected to the MIDI OUT connector / RS422 connector / GPI connector.

**1. Connect your external device to the MIDI IN connector / RS422 connector / GPI connector of the engine or console.**



- If the PM1D system is being used in Mirror mode, and the GPI connector is selected as the output destination for fader start, the output will always be linked for engine A and B. If the MIDI connector or RS422 connector is selected as the output destination, the command will be output only to the currently-enabled engine.
- If the PM1D system is being used in Dual Console mode (→p.11), it will make no difference to the Fader Start function whether you operate the fader of one or the other console. Also, fader start settings may be made from either console, and the MIDI connector / RS422 connector / GPI connector of either console may be specified as the output destination.

It will also make no difference to the Fader Start function whether you operate the fader from the PC (PM1D Manager). However if you connect a PC to a system that includes a console, it will not be possible to make fader start settings from the PC. In this case, you must make these settings from the console.

**2. Access the MIDI/GPI/TC function FADER START screen.**

**3. Use the buttons of the ASSIGN MODE area to select how you will make fader start assignments.**

• **If you select the INPUT CH button**

The INPUT CH/UNIT area will display the odd-numbered input channels (in vertical pair mode, channels 1–48) and the L channels of ST IN. The name display field will show the short name of the channel or the unit name, according to the NAME MODE you selected at the bottom of the screen.

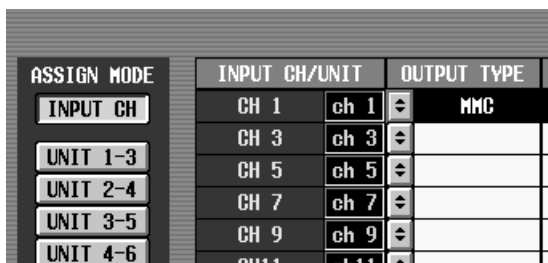

• **If you select UNIT 1-3 – UNIT 8-10**

The INPUT CH/UNIT area will display only the odd-numbered ports of the usable units/cards/ports. In this case, the name display area will always show the unit name.

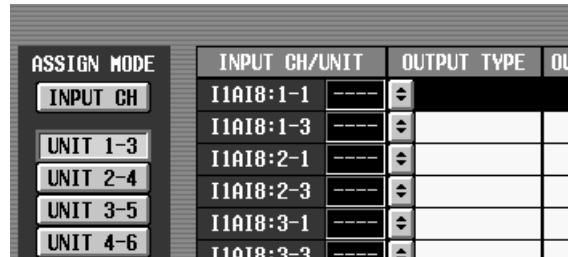

If you select UNIT 1-3 – UNIT 8-10 as the ASSIGN MODE, you will be able to make fader start assignments that depend on patch settings.

For example if multiple audio sources are being input separately to the ports of multiple units, you can create patch library or scene settings that successively connect different audio sources to the same fader, so that the same fader can be used for fader start operation even after recall.

When you click the ASSIGN MODE button, the FADER START INITIALIZE popup window will appear, asking you whether it is OK to initialize the fader start settings.



- If the INPUT CH button is on, only every other fader will be usable for the Fader Start function. If the corresponding input channel is paired, you can use the other fader to control the Fader Start function.
- If you want to assign the Fader Start function to the faders of consecutively-numbered input channels, turn on one of the UNIT 1-3 – UNIT 8-10 buttons, and assign consecutive input channels to each port, or else use Vertical Pair mode.

**4. If it is OK to initialize the fader start settings, click the OK button to close the popup window.**

When you click the OK button, all existing settings will be lost.

5. Scroll the list to display the channel/unit that you want to assign, and click the  button in the OUTPUT TYPE field.

The FADER START SETUP popup window will appear, allowing you to select the type of signal that will be sent.

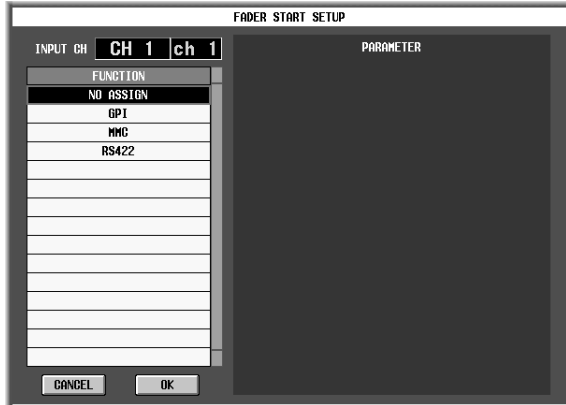

6. In the FUNCTION field, select the type of signal that you want to send: GPI, MMC, or RS422.
7. As necessary, specify parameters in the PARAMETER area at the right.

- **If you selected GPI**

Use the GPI PORT buttons to select the GPI port (console 1/2, engine) to which the command will be sent.

Set START PORT to specify the port number (1–8) that will output the signal when a fader start trigger is received. Set END PORT to specify the port number (1–8) that will output the signal when a fader end trigger is received.

 In order to enable GPI, you must go to the MIDI/GPI/TC function GPI screen, and make GPI output settings (POLARITY, TRIGGER/TOGGLE)

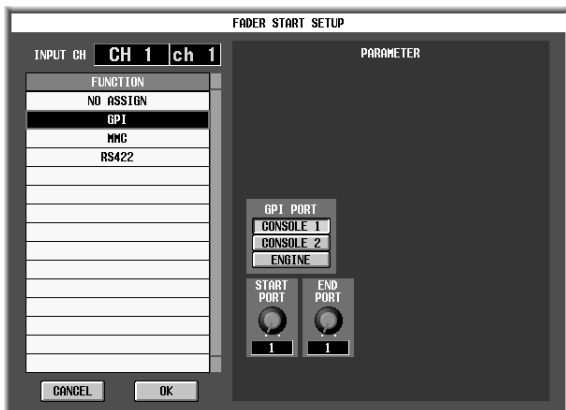

- **If you selected MMC**

Use the MIDI PORT buttons to select the MIDI port (console 1/2, engine) to which the command will be sent. Set the MMC ID knob value to match the ID (1–127, ALL) of the external MIDI device that will receive the command.

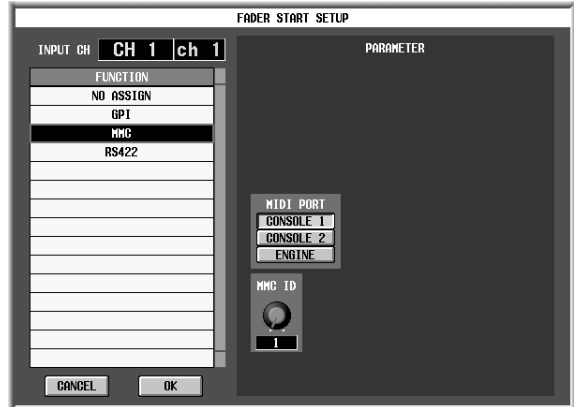

 Only one type (P2 or DENON) can be selected as the REMOTE [RS422] command format for each component.

- **If you selected RS422**

Use the RS422 PORT buttons to select the RS422 port (console 1/2, engine) to which the command will be sent. Use the FORMAT knob to select the format (P2 or DENON) of the RS422 protocol.

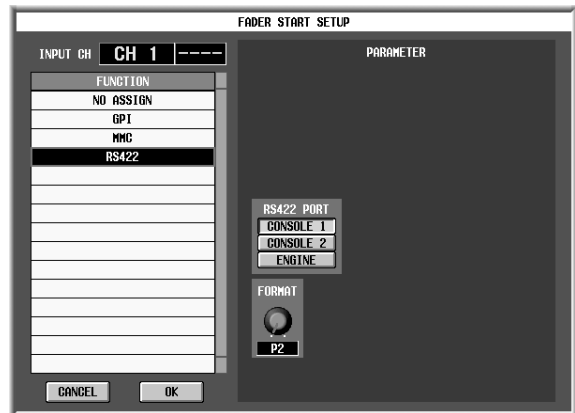

8. When you have finished making parameter settings, click [OK].

You will return to the FADER START screen.

 If another function had already been assigned to the GPI port you choose as the destination, a message of “GPI OUT SETUP IN USE WAS STOLEN” will appear at the bottom of the screen when you click the OK button, and the settings for that port will be defeated. You can check the assigned function in the MIDI/GPI/TC function GPI screen.

9. Use the same procedure to make settings for other channels/units.

The following steps will differ slightly depending on whether you are using MMC/RS422 or GPI.

■ When using MMC/RS422

10. Operate the corresponding fader.

If you selected MMC as the control signal, the MMC PLAY command and STOP command will be transmitted from the specified MIDI OUT connector when you raise and lower the fader.

For details on P2 and DENON, refer to the explanation for GPI RS422 (→p.38).

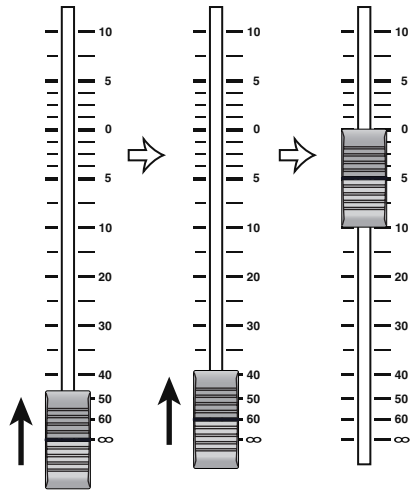

MIDI OUT  
  
 ↓  
**MMC  
 PLAY command**

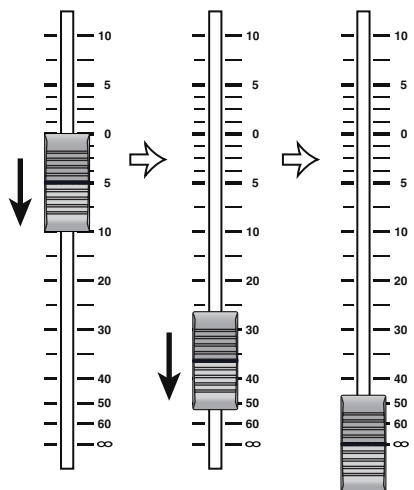

MIDI OUT  
  
 ↓  
**MMC  
 STOP command**

If you selected RS422 as the control signal, the RS422 protocol PLAY command and STOP command (if P2 format is selected) or the PLAY command and PAUSE command (if DENON format is selected) will be transmitted from the specified RS422 connector when you raise and lower the fader.

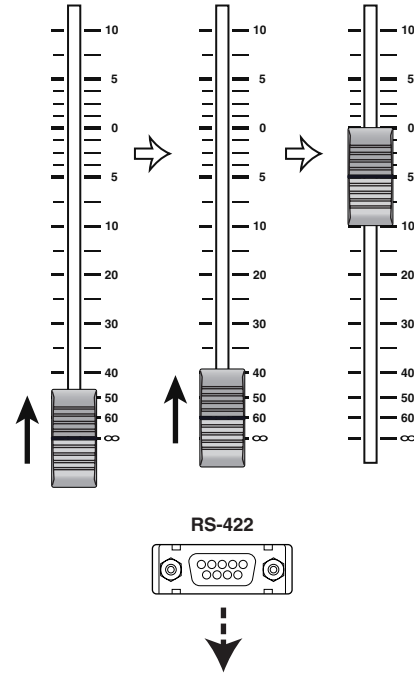

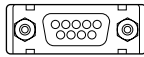
RS-422  
  
 ↓  
**RS422 protocol  
 PLAY command**

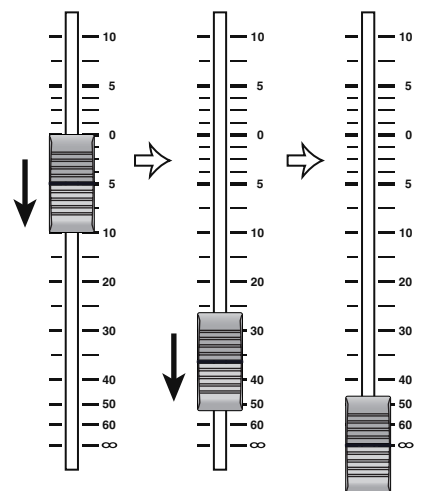

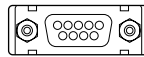
RS-422  
  
 ↓  
**RS422 protocol  
 STOP/PAUSE command**

■ When using GPI

11. Access the GPI screen.

For the GPI OUT port to which you assigned fader start, the ASSIGNED TRIGGER field will indicate FADER START. If you specified different GPI OUT ports as the start port and end port, the display will appear as follows.

GPI OUT									
OUTPUT PORT			POLARITY		TEST		ASSIGNED TRIGGER		PARAMETER
CONSOLE 1	PORT 1	H	TRIGGER	⌋	⌋	+	⇅	FADER START	[START] CH 1
CONSOLE 1	PORT 2	H	TRIGGER	⌋	⌋	+	⇅	FADER START	[END] CH 1
CONSOLE 1	PORT 3	H	TRIGGER	⌋	⌋	+	⇅		
CONSOLE 1	PORT 4	H	TRIGGER	⌋	⌋	+	⇅		
CONSOLE 1	PORT 5	H	TRIGGER	⌋	⌋	+	⇅		
CONSOLE 1	PORT 6	H	TRIGGER	⌋	⌋	+	⇅		
CONSOLE 1	PORT 7	H	TRIGGER	⌋	⌋	+	⇅		
CONSOLE 1	PORT 8	H	TRIGGER	⌋	⌋	+	⇅		

If you specified the same GPI OUT port as the start port and end port, the display will appear as follows.

GPI OUT									
OUTPUT PORT			POLARITY		TEST		ASSIGNED TRIGGER		PARAMETER
CONSOLE 1	PORT 1	H	TRIGGER	⌋	⌋	+	⇅	FADER START	[START] CH 1 ...
CONSOLE 1	PORT 2	H	TRIGGER	⌋	⌋	+	⇅		
CONSOLE 1	PORT 3	H	TRIGGER	⌋	⌋	+	⇅		
CONSOLE 1	PORT 4	H	TRIGGER	⌋	⌋	+	⇅		
CONSOLE 1	PORT 5	H	TRIGGER	⌋	⌋	+	⇅		
CONSOLE 1	PORT 6	H	TRIGGER	⌋	⌋	+	⇅		
CONSOLE 1	PORT 7	H	TRIGGER	⌋	⌋	+	⇅		
CONSOLE 1	PORT 8	H	TRIGGER	⌋	⌋	+	⇅		

⚠ The settings of a GPI OUT port to which you assigned the fader start function cannot be edited in the GPI screen. If you want to edit these settings, you must return to the FADER START screen. However if you select a different item in the ASSIGN TRIGGER field of the GPI screen, the bottom of the screen will indicate “GPI OUT SETUP IN USE WAS STOLEN,” and the FADER START screen settings for that port will be defeated.

- 12. Use the button in the OUTPUT PORT field to select either TOGGLE or TRIGGER as the transmission method for the signal that is output from GPI OUT.
- 13. Use the buttons in the POLARITY field to select the polarity of the signal that is output from GPI OUT.
- 14. Operate the appropriate fader.

When GPI is selected as the control signal, the operation will depend on the settings of the GPI screen OUTPUT PORT field and POLARITY field, and on the parameter settings in the FADER START screen.





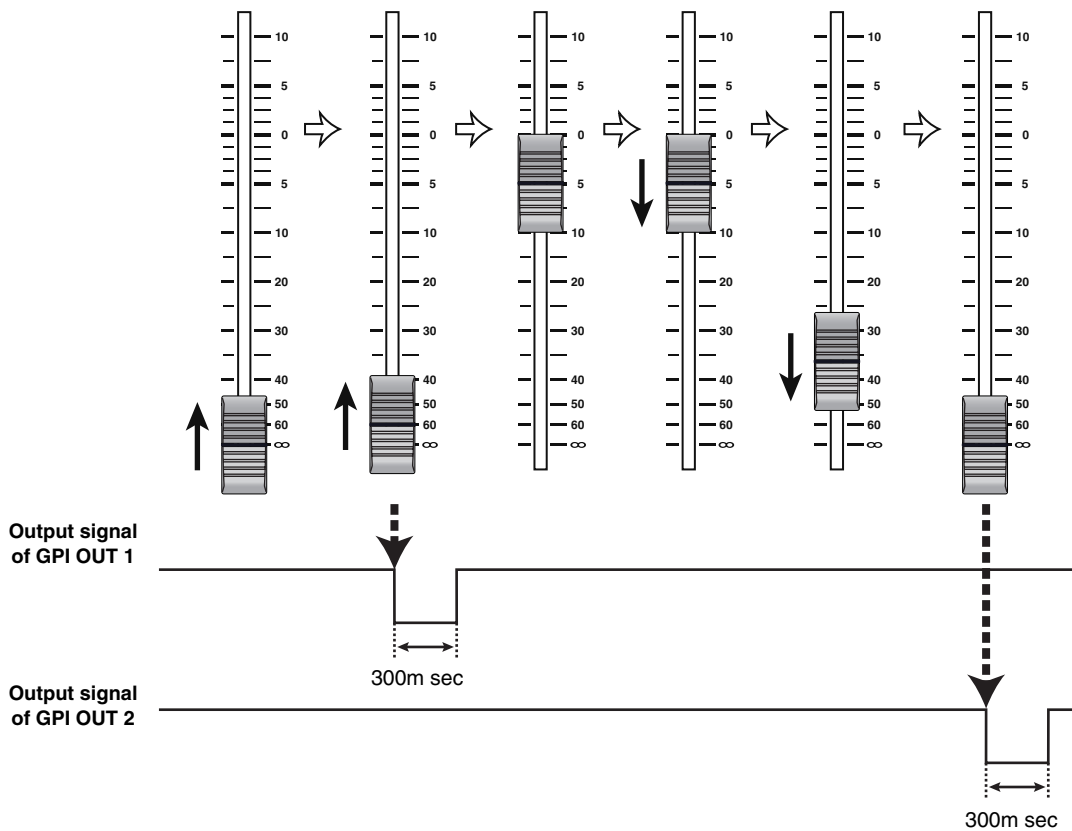



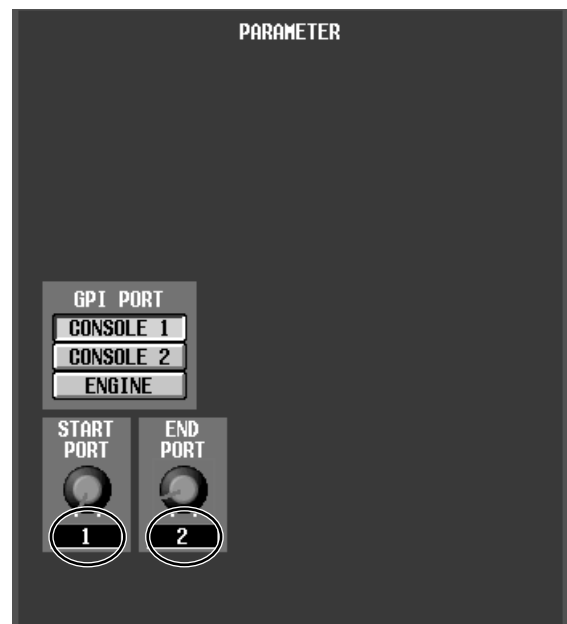

The following diagram is an example of how trigger signals (low active) are transmitted from GPI OUT ports 1 and 2 to an external device when fader start and fader end occur.



To produce this type of operation, first go to the FADER START screen, select GPI as the control signal for the corresponding faders, and specify START PORT = 1 and END PORT = 2.



Next, move to the GPI screen, and for GPI OUT ports 1/2, set the OUTPUT PORT button to **TRIGGER** and the POLARITY button to  (low active).

GPI OUT		OUTPUT PORT	POLARITY	TEST	ASSIGNED TRIGGER	PARAMETER
CONSOLE 1	PORT 1	H	TRIGGER	  + ⇄	FADER START	[START] CH 1
CONSOLE 1	PORT 2	H	TRIGGER	  + ⇄	FADER START	[END] CH 1
CONSOLE 1	PORT 3	H	TRIGGER	  + ⇄		
CONSOLE 1	PORT 4	H	TRIGGER	  + ⇄		

 The interval of the trigger signal is fixed at 300m sec.

The following diagram is an example of how the low level signal and high level signal are switched for GPI OUT port 1 when a fader start occurs and when a fader end occurs.

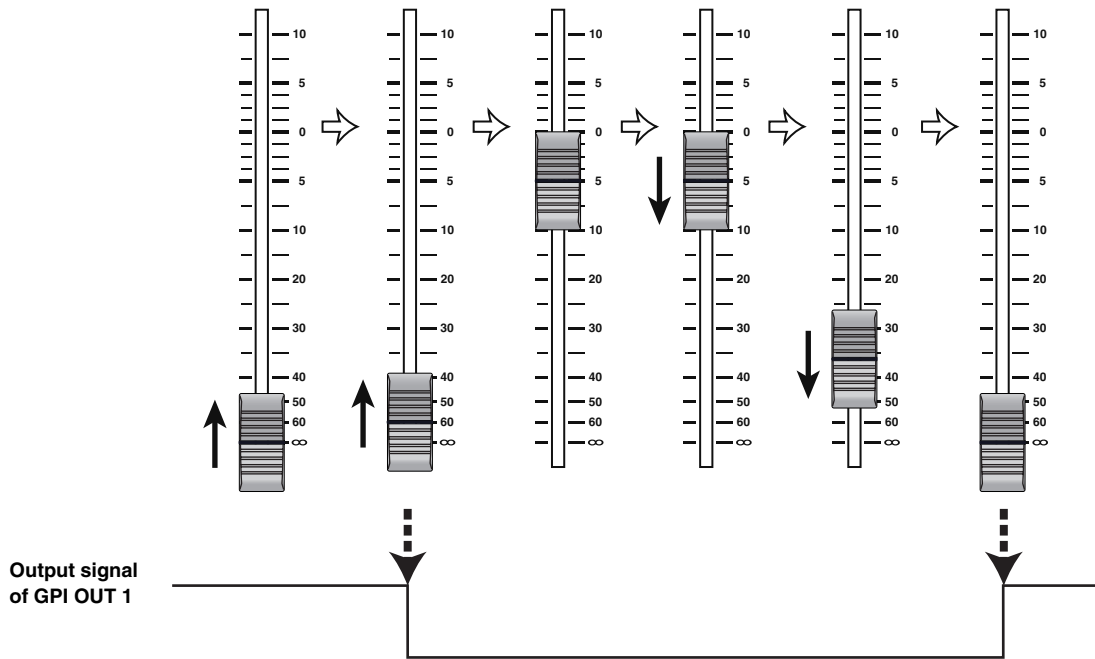

To produce this type of operation, first go to the FADER START screen, select GPI as the control signal for the corresponding fader, and specify START PORT = 1 and END PORT = 1.

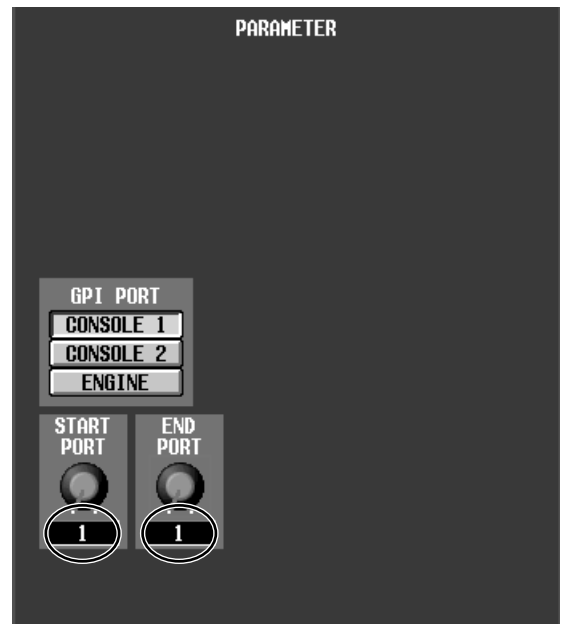

Next, move to the GPI screen, and for that GPI OUT port, set the OUTPUT PORT button to **TOGGLE** and the POLARITY button to **⏏** (low active).

GPI OUT					ASSIGNED TRIGGER	PARAMETER
OUTPUT PORT		POLARITY	TEST			
CONSOLE 1 PORT 1	H	TOGGLE	⏏	⏏	FADER START ...	[START] CH 1 ...
CONSOLE 1 PORT 2	H	TRIGGER	⏏	⏏		
CONSOLE 1 PORT 3	H	TRIGGER	⏏	⏏		
CONSOLE 1 PORT 4	H	TRIGGER	⏏	⏏		

## Tap Tempo function

PM1D system software V1.5 provides a “Tap Tempo function” which lets you manually set the TEMPO parameter of an internal effect by tapping an external switch connected to the GPI connector. Here’s how to use this function.

1. Connect an external switch to the GPI connector of the engine or console.
2. Access the MIDI/GPI/TC function GPI screen.
3. Scroll the GPI IN list until you see the INPUT port to which is connected the switch you will use for tapping.
4. According to the character of the signal that is sent from the external switch, set the TRIGGER field to either low active (On when the switch is grounded) or high active (On when a high-level signal is input, or when open).
5. Click  at the left of the FUNCTION field to open the GPI IN SETUP popup window.
6. Scroll the list at the left, and select TAP TEMPO as the function.

TAP TEMPO has no parameters to set.

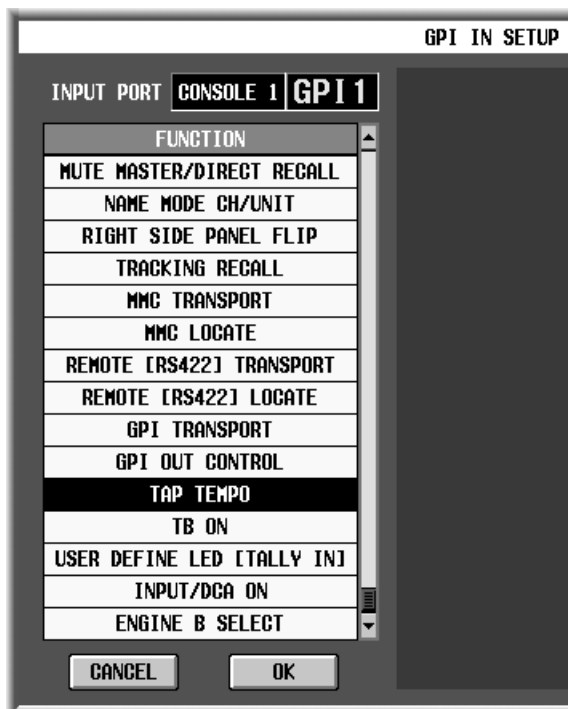

7. Click the OK button to close the popup window. With these settings, you have completed the preparations for using an external switch with the Tap Tempo function.
8. Access the desired screen EFFECT 1–EFFECT 8.

9. From the effect library, recall an effect of a type that contains a TEMPO parameter (e.g., Delay LCR, Echo, Chorus).

TEMPO is a parameter that lets you specify a time-related effect parameter (such as DELAY in Delay LCR or Echo, or FREQ. in Chorus) in terms of BPM units.



10. At intervals of the desired tempo, press the external switch that you assigned to the Tap Tempo function.

When you have pressed the switch four times, the average value (BPM) of the three intervals will be calculated, and that value will be input to the TEMPO parameter.

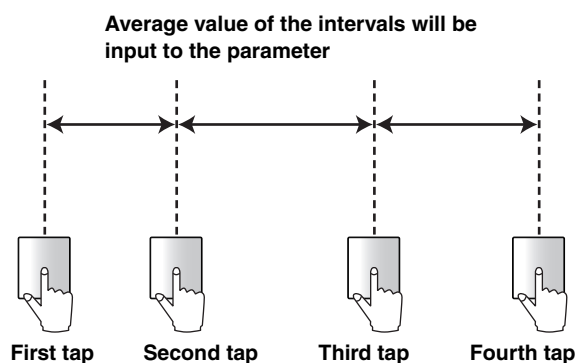

- ⚠ The Tap Tempo function is valid only for the currently-displayed internal effect. However, it does nothing if the effect type does not include a TEMPO parameter.
- If the average value is outside the range of 20–300 BPM, it will be ignored.
- Due to functional limitations, you cannot use the Tap Tempo function by clicking the GPI IN test button located at the bottom of the screen.

## Added functions in the USER DEFINE screen

The following functions can now be selected in the UTILITY function USER DEFINE screen.

- MANUAL FADE ON
- MUTE MASTER/DIRECT RECALL
- NAME MODE CH/UNIT
- RIGHT SIDE PANEL FLIP
- TRACKING RECALL
- MMC TRANSPORT
- MMC LOCATE
- REMOTE [RS422] TRANSPORT
- REMOTE [RS422] LOCATE
- GPI TRANSPORT
- GPI OUT CONTROL

The options and parameters of each item are the same as for the items in the GPI screen GPI IN SETUP popup window. Refer to page 37 and 38 for details.



To access the USER DEFINE screen, you can either press the console [UTILITY] switch (located in the LCD FUNCTION ACCESS block) several times, or click the on-screen MENU button → UTILITY button → USER DEFINE tab.

## Input channel panel assignments

The layout of the input channels assigned to INPUT blocks 1–4 of the console (CS1D) can now be freely specified in units of twelve consecutive channels. In the same way, the ST IN channels assigned to ST IN block 1/2 can be specified in units of two consecutively-numbered channels.

The panel assign settings can be saved as a user pattern. Furthermore, you can choose any of eight patterns (two preset, six user patterns) and use a switch such as FADER FLIP to select them successively.

## PANEL ASSIGN screen

In the UTILITY function, a PANEL ASSIGN screen has been added, allowing you to make panel assign settings.

The screenshot shows the 'PANEL ASSIGN' screen within the 'UTILITY' function. At the top, there's a status bar with 'UTILITY' in large letters, and various system parameters like 'CONNECTION 1 A B', 'PANEL STATUS', and 'SCENE MEMORY 18.620020718'. Below this is a navigation bar with tabs for 'PREFERENCE', 'USER DEFINE', 'LOAD / SAVE', 'PANEL ASSIGN' (selected), and 'PAIR MODE'. The main area is divided into several sections: 'MODULE FLIP BUTTON MODE' with 'MODULE FLIP' and 'PATTERN CHANGE' buttons; 'PATTERN INITIALIZE' with an 'INITIALIZE' button; 'PRESET PATTERN MODE' with 'UPPER-LOWER' and 'LEFT-RIGHT' buttons; 'LEFT SIDE PATTERN' and 'RIGHT SIDE PATTERN' sections, each with 'PATTERN 1' and 'PATTERN 5' labels; a 'CURRENT ASSIGN' section showing channel and ST assignments (e.g., 13-24, ST3-4, 37-48) with 'FADER FLIP' and 'CH LINK CH' buttons; and a bottom section with eight pattern slots (PATTERN 1-8) for enabling and disabling specific channel and ST assignments. At the very bottom, there's a status bar with 'CONSOLE STATUS 1 / 4', 'IN SEL CH 2', 'NAME MODE UNIT NAME CH NAME', 'MODULE PATT [L] PATT [R]', 'MIX SEND NO. MIX46', 'MASTER FADER DCA', and 'OUT SEL ST B[L]'.

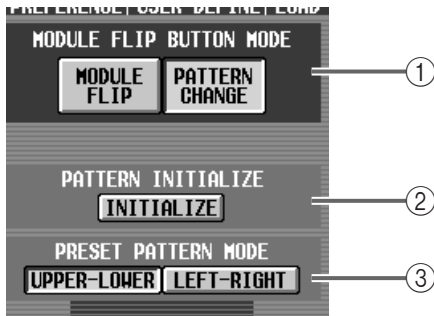

① **MODULE FLIP BUTTON mode**

These buttons choose one of the following two functions for the MODULE [FLIP] switch in the SELECTED INPUT CHANNEL section. (This also applies to a USER DEFINE switch or GPI IN trigger to which the RIGHT SIDE PANEL FLIP function is assigned.)

- **MODULE FLIP** .....As in previous versions, the input channels assigned to the upper and lower INPUT blocks will be changed.
- **PATTERN CHANGE** . Each time you press the MODULE [FLIP] switch, the panel assignment patterns registered in the pattern list (⑦) of the PANEL ASSIGN screen will be selected successively.

⚠ If you turn off the MODULE FLIP/PATTERN CHANGE LINK button (①), the MODULE [FLIP] switch will be valid only for the left side of the panel (INPUT block 1/2).

In this case, module flip switching for the right side (ST IN block 1/2, INPUT block 3/4) is performed by the USER DEFINE switches, the MODULE buttons located in the lower part of the screen, or the GPI function RIGHT SIDE PANEL FLIP (→p.37).

② **PATTERN INITIALIZE**

When you click this button, the PANEL ASSIGN screen settings (with the exception of PRESET PATTERN MODE (③)) will be initialized.

③ **PRESET PATTERN MODE**

These buttons select one of the following two arrangements for the preset patterns (patterns 1 and 5).

• **UPPER-LOWER**

This is the existing default arrangement, in which input channels are arranged in the order of INPUT block 1→2→3→4.

• **LEFT-RIGHT**

Input channels are arranged in the order of INPUT block 1→3→2→4.

Preset pattern 1 will be as follows when each arrangement is selected.

**UPPER-LOWER**

INPUT block 2 <b>CH13-24</b>	INPUT block 4 <b>CH37-48</b>
INPUT block 1 <b>CH1-12</b>	INPUT block 3 <b>CH25-36</b>

**LEFT-RIGHT**

INPUT block 3 <b>CH25-36</b>	INPUT block 4 <b>CH37-48</b>
INPUT block 1 <b>CH1-12</b>	INPUT block 2 <b>CH13-24</b>

- ⚠ • Even if you use the PATTERN INITIALIZE button (②) to execute initialization, the PRESET PATTERN MODE setting will not be affected. When you execute initialization, the arrangement of pattern 1 will be copied to patterns 2–4, and the arrangement of pattern 5 will be copied to patterns 6–8. This means that the PRESET PATTERN MODE settings (UPPER-LOWER/LEFT-RIGHT) will be applied to all patterns 1–8.

- The arrangement of the SCENE function TRACKING RECALL screen (when the MODE button has selected INPUT 1–48 or INPUT 49–96) and the METER function input channel screens will change according to the PRESET PATTERN MODE.

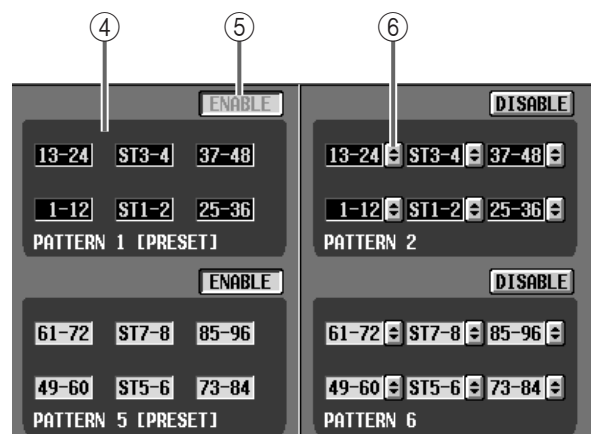

④ **Pattern display area**

This area shows the channel configurations of the preset patterns (patterns 1 and 5) and user patterns (patterns 2–4, 6–8).

⑤ **ENABLE/DISABLE**

Enables/disables each pattern. Patterns for which this button is set to ENABLE will be registered in the pattern list (⑦).

⚠ It is not possible to disable the ENABLE button of the currently selected pattern. If you want to disable it, use the MODULE [FLIP] switch to select a different pattern as the panel assignment, and then operate the ENABLE button.

⑥ **Channel select**  
You can click the  button to edit each block of a user pattern.

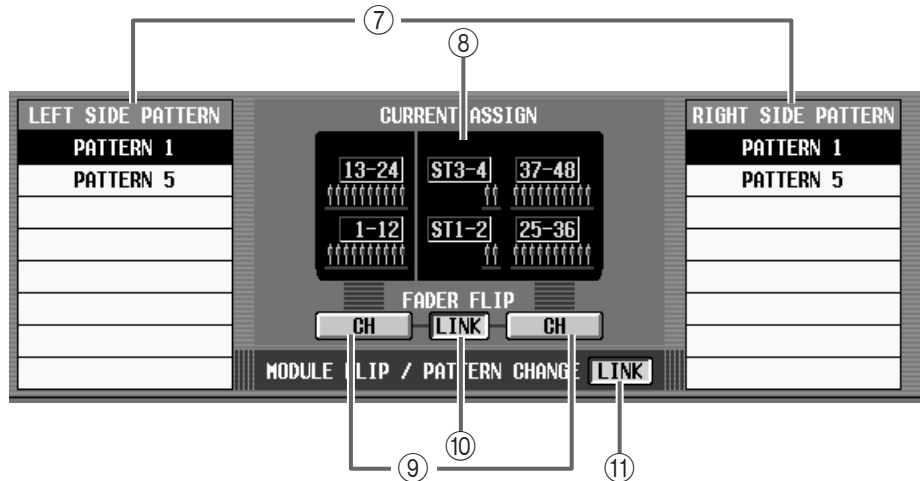

⑦ **Pattern list**  
These areas list the patterns that you registered using the ENABLE button. The list is divided into the left (INPUT block 1/2) and right (INPUT block 3/4, ST IN block 1/2) sides of the panel.

The patterns registered in this list can be switched in the following ways.

- Click in the on-screen pattern list to select a pattern directly.
- Select PATTERN CHANGE for the MODULE FLIP BUTTON MODE (①), and press the MODULE [FLIP] switch located in the SELECTED INPUT CHANNEL section of the panel.
- Select PATTERN CHANGE in (①), and operate the USER DEFINE switch or GPI IN control source to which you assigned the RIGHT SIDE PANEL FLIP function.
- Select PATTERN CHANGE in (①), and click the PATT [L] or PATT [R] button in the MODULE area at the bottom of the screen.
- In the PANEL STATUS area at the top of the screen, click the channel number.

However depending on the MODULE FLIP/PATTERN CHANGE LINK (⑪) setting, pattern switching may not be linked between the left side and right side of the panel.

⑧ **CURRENT ASSIGN**  
Indicates the panel assign status that is currently valid. This is the same as displayed in the PANEL STATUS area (→p.6) in the upper part of the screen.

⑨ **FADER FLIP**  
Switches the fader flip mode (CH or MIX). This is the same function as the FADER FLIP screen on the panel, or the FADER FLIP button (→p.6) in the PANEL STATUS area located in the upper part of the screen.

⑩ **FADER FLIP LINK**  
Specifies whether FADER FLIP button (9) operations will be linked between the left and right sides of the panel. If this button is off, operations of the panel FADER FLIP switch will affect only the left side of the panel.



If this button is off, fader flip for the right side can be switched using a USER DEFINE switch, or the FADER FLIP button (→p.6) in the PANEL STATUS area located in the upper part of the screen, or the RIGHT SIDE PANEL FLIP function assigned to a GPI control (→p.37).

⑪ **MODULE FLIP/PATTERN CHANGE LINK**  
Specifies whether MODULE [FLIP] button operations will be linked for both sides of the panel. If this button is off, operations of the MODULE [FLIP] button will affect only the left side of the panel.



- The actual result of pressing the MODULE [FLIP] button will depend on the MODULE FLIP BUTTON MODE (①).
- If this button is turned off, module flip for the right side can be switched using a USER DEFINE switch, the MODULE buttons at the bottom of the screen, or the RIGHT SIDE PANEL FLIP function assigned to a GPI control (→p.37).

## Switching the panel assign setting

1. **Access the UTILITY function PANEL ASSIGN screen.**
2. **Click the INITIALIZE button.**  
The settings of the PANEL ASSIGN screen will be initialized (except for PRESET PATTERN MODE).
3. **In the pattern display area, use the  buttons for the user patterns (patterns 2–4, 6–8) to specify the channels that you want to assign to each pattern.**  
If desired, you may assign the same group of channels to more than one INPUT block, or combine groups of input channels 1–48 with groups of input channels 49–96.
4. **For the pattern that you want to use, switch the ENABLE/DISABLE button to “ENABLE.” The selected pattern will be registered in the pattern list, in the order of its pattern number.**
5. **Turn on the PATTERN CHANGE button of the MODULE FLIP BUTTON MODE section.**  
Now you can use the MODULE [FLIP] switch to change the panel assign pattern.
6. **Press the MODULE [FLIP] switch.**  
The patterns registered in the pattern list will change sequentially.



If you select a preset pattern (pattern 1, 5), the [FLIP] switch LED will go dark. If you select a user pattern (pattern 2–4, 6–8), the [FLIP] switch LED will light.

7. **If you don't want the MODULE [FLIP] switch to affect the left and right sides of the panel in tandem, turn off the MODULE FLIP/PATTERN CHANGE LINK button.**  
In this case, you can assign the RIGHT SIDE PANEL FLIP function to a USER DEFINE switch (or to GPI IN), and use that USER DEFINE switch (or GPI IN) to operate fader flip for the right side.



If patterns 1 and 5 are registered in the pattern list, you can use the GLOBAL LAYER [1-48]/[49-96] switches to select patterns 1 and 5. Press the GLOBAL LAYER [1-48] switch to select pattern 1, or the [49-96] switch to select pattern 5.

-  If you placed the same input channels in a different INPUT block, you can use the [SEL] switches of either block to set/defeat pairing. Also note that the [SEL] switches of adjacent channels will set/defeat pairing when they are pressed simultaneously even if the switches are in different blocks.



An INPUT [PANEL] button has been added to the DISPLAY SELECT section of the TRACKING RECALL screen.



If the INPUT [PANEL] button is pressed, the offset display of the TRACKING RECALL screen will be arranged in the same order as the console layout specified by panel assign. Since the order is the same as the console layout, operation and checking will be easier.

However, it is not possible to press this button in PM1D Manager since it does not have a panel assign function.

## Horizontal pair and vertical pair

When input channels are paired, the method of pairing adjacent channels such as 1+2, 3+4... (as in previous versions of the system) is called “horizontal pair mode.” Version 1.5 now also allows channels to be paired in combinations such as 1+49, 2+50..., and this is called “vertical pair mode.”

When you switch from horizontal pair mode to vertical pair mode, new numbers will be assigned to each input channel as follows:

- channel 1 → no change
- channel 2 → channel 49
- channel 3 → channel 2
- channel 4 → channel 50
- channel 5 → channel 3
- channel 6 → channel 51
- channel 7 → channel 4
- channel 8 → channel 52

However, please note that this simply means that the input channel previously called “channel 2” has now been renamed “channel 49” and changed places on the panel. Elements such as unit assignments, channel name, and mix parameters do not change. This means that even if you switch from horizontal pair mode to vertical pair mode, the combinations that can be paired will not change.

In each screen of the display (except for the PANEL ASSIGN screen and TRACKING RECALL screen), switching to vertical pair mode merely changes the displayed numbers; the configuration will stay the same as in horizontal pair mode.

Horizontal pair mode

INPUT UNIT		IN 10							
SLOT		1		2		3		4	
PORT		1	2	1	2	1	2	1	2
UNIT NAME									
CH	ASSIGN	3	3	3	3	2	2	2	1
CH 1	AE-1	●							
CH 2	AE-2		●						
CH 3	AE-3			●					
CH 4	AE-4				●				
CH 5	AE-5					●			
CH 6	AE-6						●		
CH 7	AE-7							●	
CH 8	AE-8								●



Vertical pair mode

INPUT UNIT		IN 10							
SLOT		1		2		3		4	
PORT		1	2	1	2	1	2	1	2
UNIT NAME									
CH	ASSIGN	3	3	3	3	2	2	2	1
CH 1	AE-1	●							
CH49	AE-2		●						
CH 2	AE-3			●					
CH50	AE-4				●				
CH 3	AE-5					●			
CH51	AE-6						●		
CH 4	AE-7							●	
CH52	AE-8								●



Here's how to use vertical pair mode.

1. **Access the UTILITY function PAIR MODE screen (a new screen in this version).**

In the PAIR MODE screen you can switch between horizontal pair mode and vertical pair mode.

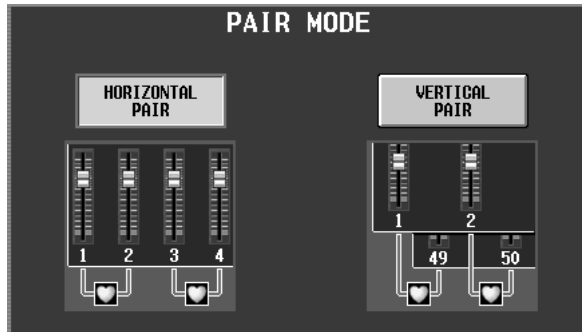

2. **Click the VERTICAL PAIR button to turn it on.** Vertical pair mode will be enabled.
3. **To specify a vertical pair, hold down the [SHIFT] switch and press the [SEL] switch of the input channel that you want to pair.**

The CHANNEL PAIRING popup window will appear, asking you to confirm the pairing.



If you have changed the panel assignment in the PANEL ASSIGN screen (→p.55), and channels that can be vertically paired are simultaneously placed on the panel, you can set/defeat pairing by pressing their two [SEL] switches simultaneously, as in previous versions.

4. **Press one of the three buttons to specify how the parameters will be copied between channels.** In this state, you can use the input channel 1 fader to control channels 1 + 49, and the input channel 2 fader to control channels 2 + 50. This is particularly convenient when you want to use adjacent faders to control multiple stereo sources.
5. **To defeat pairing, hold down the [SHIFT] switch and press the same [SEL] switch as you did in step 3.**

The RELEASING CHANNEL PAIRING popup window will appear, asking you to confirm that you want to defeat pairing. To defeat pairing, click the OK button.



You can also set/defeat vertical pairing by clicking the pair button in the appropriate screen.



- In order to use the [SHIFT] switch + [SEL] switch to set/defeat vertical pairing, both “PROHIBIT PAIR CHANGE ON PANEL” and “L,R-MONO SELECT ON PANEL” must be turned off in the PREFERENCE screen.
- If both “PROHIBIT PAIR CHANGE ON PANEL” and “L,R-MONO SELECT ON PANEL” are on, pressing the [SHIFT] switch + input channel [SEL] switch will select LR-MONO.

## Mix minus

You can now quickly exclude the signal of a specific channel from the signals sent to a VARI type MIX bus. (This operation is called “mix minus.”)

For example, this is convenient in situations where a performer or announcer wants to monitor the same mix as the STEREO bus, but does not want to hear the sound s/he is producing.

## New functions in the PAN/ROUTING screen

In order to allow the mix minus operation, the following buttons have been added to the PAN/ROUTING screen.

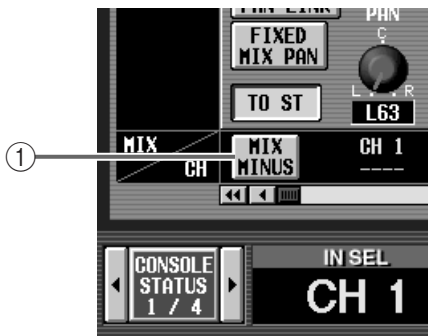

### ① MIX MINUS button

This button excludes only the signal of the corresponding channel from the signal that is sent to the specified MIX bus. When you click this button a popup window will appear, allowing you to select the applicable MIX bus.

You can also access this popup window by simultaneously pressing the [SEL] switch of the INPUT/ST IN block and the [SEL] switch of the MIX block.



### ② POST ON/POST TO ST button

This button switches the point from which the signal is taken when the post-fader signal is sent to adjacent odd-numbered / even-numbered VARI-type MIX buses.

If **POST ON is selected**, the signal will be sent from immediately after the [ON] switch of the input channel. If **POST TO ST is selected**, the signal immediately after the [TO ST] switch will be sent.

The following diagrams show how the signal flow differs according to whether the MIX bus 1/2 POST ON/POST TO ST button is set to POST ON or POST TO ST.

- POST ON/POST TO ST = **POST ON**

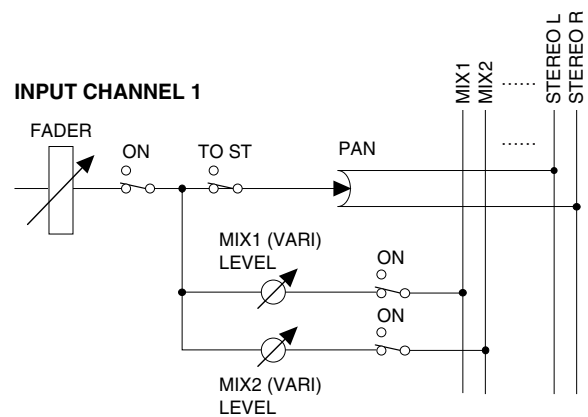

- POST ON/POST TO ST = **POST TO ST**

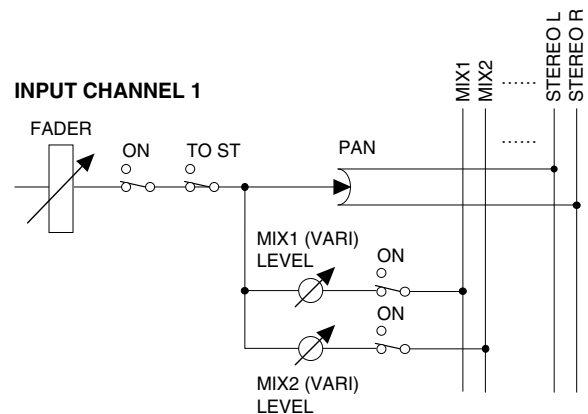

When you click the MIX MINUS button to use the mix-minus function, the POST ON/POST TO ST button of that MIX bus will automatically switch to POST TO ST.

The setting of the POST TO ST button is valid in FIX mode as well.

## Using mix minus

1. Access the PAN/ROUTING function CH to MIX screen.
2. Display the input channel whose signal you want to exclude from the MIX bus, and click the MIX MINUS button for that channel.  
The MIX MINUS SETTING popup window will appear.

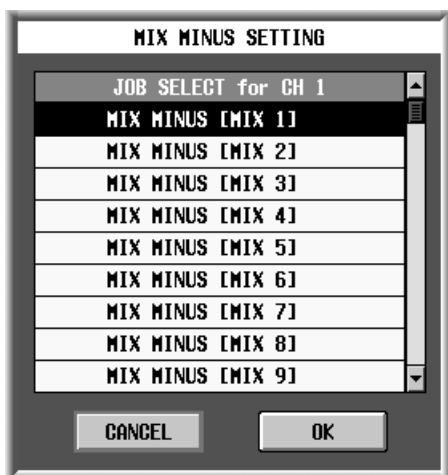

You can also open the MIX MINUS SETTING popup window by simultaneously pressing the INPUT/ST IN block [SEL] switch and the MIX block [SEL] switch.

3. Scroll the list to select the applicable MIX bus.



- Instead of scrolling the list, you can select the MIX button by pressing a [SEL] key in the MIX block.
- If desired, you can press a [SEL] switch of the INPUT block / ST IN block while this popup window is displayed, to switch the input channel whose signal will be excluded from the MIX bus.

4. Click the OK button.

When you click the OK button in the MIX MINUS SETTING popup window, the settings of the PAN/ROUTING screen will change as follows.

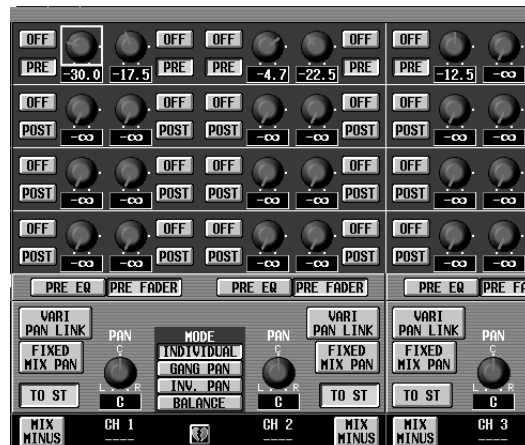

Before executing the Mix Minus operation

The POST ON/POST TO ST button of the applicable MIX bus will change to POST TO ST.

The PRE/POST buttons of the applicable MIX bus will all change to POST.

The send level of the signal that is sent from the selected input channel to the applicable MIX bus will be lowered to  $-\infty$ . The MIX send ON/OFF button will automatically turn ON.

The send level of the signals sent to the applicable MIX bus from all channels other than the above will be set to nominal level (0.0 dB). The MIX send ON/OFF button will automatically turn on.



After executing the Mix Minus operation for input channel 1 → MIX bus 1

With these settings, the identical signal as sent to the STEREO bus, but with just the corresponding input channel excluded, will be sent to the desired MIX bus.

## Cautions regarding mix minus

Please be aware of the following items when you use mix minus.

- Mix minus is a shortcut for rapidly making settings ; it is not like changing a “mode.” This means that even after executing mix minus, you are still free to edit the various parameters in the CH to MIX screen.
- The mix minus operation always applies only to the last-selected input channel. If you want to exclude two or more input channels from the signals that are sent to a specific MIX bus, execute the mix minus operation and then edit the settings manual.
- The setting of the POST ON/POST TO ST button applies to two adjacent odd-numbered / even-numbered MIX buses. This means that, for example, if you execute the mix minus operation on MIX bus 1, the signal being sent to MIX bus 2 may also be affected. (Signals from an input channel whose [TO ST] button is turned off will not be sent to either MIX buses 1 or 2.)
- The mix minus operation is valid only for VARI type MIX buses. You cannot select the MIX MINUS setting popup window for a FIX type MIX bus. If you want to obtain mix minus results with a FIX type MIX bus, you can easily do so by using the job select operation described on the next page.
- If an input channel is paired (or if a ST IN channel is selected), the send level of the signal sent from both channels to the applicable MIX bus will be  $-\infty$ .
- The mix minus operation is valid even if the applicable MIX bus is paired. In this case, the PAN settings of adjacent odd-numbered / even-numbered input channels will be reflected by the PAN settings of the paired MIX buses.

The PAN settings of adjacent odd-numbered / even-numbered input channels will be reflected by the PAN of the paired MIX buses.

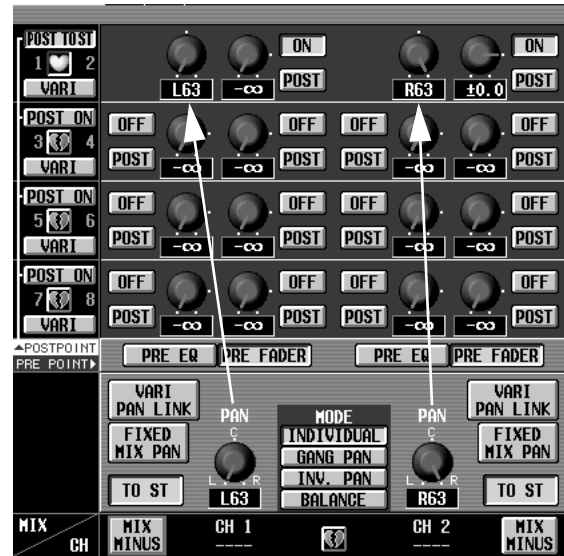

After executing mix minus for input channel 1 → paired MIX buses 1/2

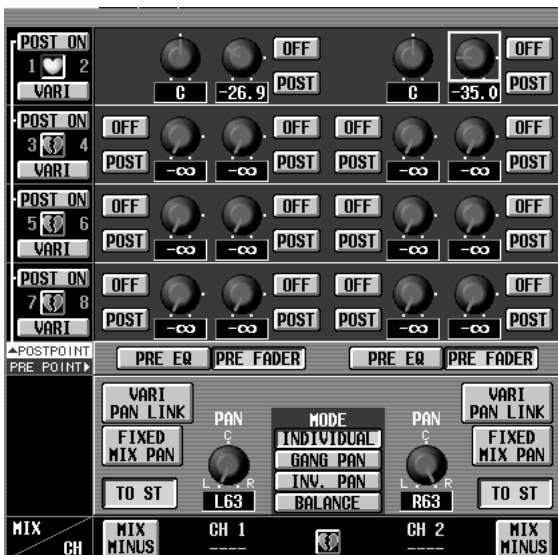

Before executing mix minus

## Job select

In PM1D system software V1.5, you can move the cursor to a specific parameter in the screen and press the [SHIFT] + [ENTER] switches to access a popup window of jobs that can be used for that parameter. (This operation is called “job select.”) If job select is available for a parameter, the cursor frame will turn yellow when it is moved to that parameter.

In version 1.5, the job select function can be used for the following parameters in the CH to MIX screen (PAN/ROUTING function).

### Mix send on/off

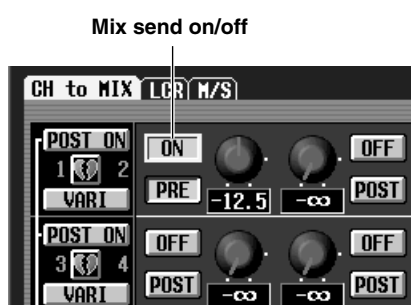

The signal sent from an input channel to a MIX bus can be switched on/off by this job. When you move the cursor to this parameter and press the [SHIFT] + [ENTER] switches, the following popup window will appear.



You can select the following jobs.

- **ALL OFF [ALL MIX ↑↓]**  
The signals sent from the selected channel to all MIX buses will be switched on or off together.
- **ALL ON [ALL MIX ↑↓]**  
The signals sent from the selected channel to all MIX buses will be switched on or off together.
- **ALL OFF [ALL CH ↔]**
- **ALL ON [ALL CH ↔]**  
The signals sent from all channels to the selected MIX bus will be switched on or off together.
- **ALL OFF [ALL CH x ALL MIX]**
- **ALL ON [ALL CH x ALL MIX]**  
The signals sent from all channels to all MIX buses will be switched on or off together.

## Mix send point



These jobs switch the pre-fader/post-fader selection for the signal sent from an input channel to a MIX bus. When you move the cursor to this parameter and press the [SHIFT] + [ENTER] switches, the following popup window will appear.

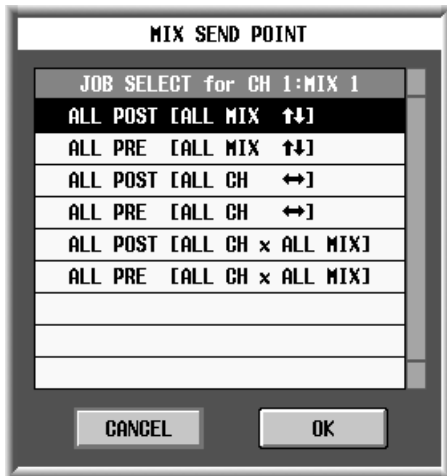

You can select the following jobs.

- **ALL POST [ALL MIX ↑ ↓]**
- **ALL PRE [ALL MIX ↑ ↓]**  
The extraction point of the signals sent from the selected channel to all MIX buses will simultaneously be switched to post-fader or pre-fader.
- **ALL POST [ALL CH ↔]**
- **ALL PRE [ALL CH ↔]**  
The extraction point of the signals sent from all channels to the selected MIX bus will simultaneously be switched to post-fader or pre-fader.
- **ALL POST [ALL CH x ALL MIX]**
- **ALL PRE [ALL CH x ALL MIX]**  
The extraction point of the signals sent from all channels to all MIX buses will be simultaneously be switched to post-fader or pre-fader.

⚠ The above job is not valid for FIX type MIX buses. If the channel on which you execute this job is either side of an LR-MONO pair, the job will operate as for paired channels

## Mix send level



Using these jobs, the value of the signal level that is sent from an input channel to a MIX bus can be copied to another channel. When you move the cursor to this parameter and press the [SHIFT] + [ENTER] switches, the following popup window will appear.



You can select the following jobs.

- **LEVEL COPY [ALL MIX ↑ ↓]**  
The value of the selected parameter will be copied to the send level of the signal that is sent from that channel to all MIX buses.
- **LEVEL COPY [ALL MIX ↔]**  
The value of the selected parameter will be copied to the send level of the signal that is sent from all channels to that MIX bus.
- **LEVEL COPY [ALL CH x ALL MIX]**  
The value of the selected parameter will be copied to the send level of the signal that is sent from all channels to all MIX buses.

⚠ The above job is not valid for FIX type MIX buses. If the channel on which you execute this job is either side of an LR-MONO pair, the job will operate as for paired channels

## Mix send pan/balance

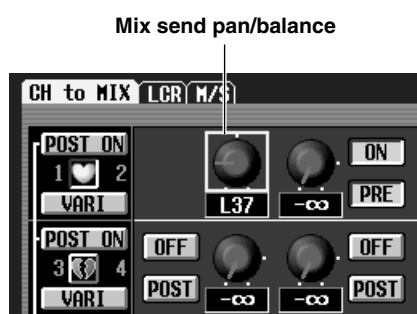

Using these jobs, the pan/balance setting of the signal that is sent from an input channel to paired MIX buses can be copied to another channel.

Move the cursor to the PAN/BALANCE knob that is displayed when MIX buses are paired, and press the [SHIFT] + [ENTER] switches to open the following popup window.



You can select the following jobs.

- **PAN (BAL) COPY [ALL MIX ↑ ↓]**  
The value of the selected parameter will be copied to the pan (balance) of the signal that is sent from that channel to all paired MIX buses.
- **PAN (BAL) COPY [ALL MIX ↔]**  
The value of the selected parameter will be copied to the pan (balance) of the signals that are sent from all channels to that MIX bus.
- **PAN (BAL) COPY [ALL CH x ALL MIX]**  
The value of the selected parameter will be copied to the pan (balance) of the signals that are sent from all channels to all paired MIX buses.

- ⚠ • The above job is not valid for unpaired MIX buses or for FIX type MIX buses.
- You cannot copy a PAN parameter to a BALANCE parameter (or vice versa).
- You cannot copy to a channel whose VARI PAN LINK is turned on.

## Auto Store function

When storing a scene in previous versions, if a unit, patch, or name included in that scene had been changed, a special popup window appeared, requiring you to specify a library number in which to save each type of data. However from version 1.5, you can use an Auto Store function which automatically selects the store-destination library number and title. This is convenient when you want to store a scene in a hurry. You can execute the audio store function either in the screen or by using the [STORE] switch.

### Using Auto Store from the screen

1. Access the SCENE function MEMORY screen, select the store-destination scene number, and then click the STORE button (or in the SCENE MEMORY section of the console, select the store-destination scene number and press the [STORE] switch).

The SCENE STORE popup window will appear, allowing you to assign a title and comment to the scene, and store it.

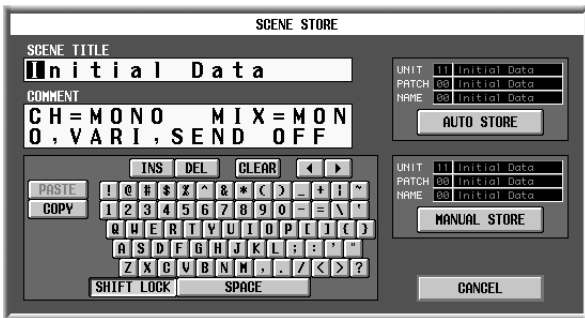

2. To execute auto store, click the AUTO STORE button.

The data will be automatically stored with the library number and title shown above the AUTO STORE button.

If the unit, patch, or name were changed, or if the most-recently stored/recalled unit library was read-only, the lowest-numbered vacant library number will be selected. In this case, the selected library will be stored with the same name as the title of the scene (shown in yellow characters).

If there was no change in the unit, patch, or name, the most-recently stored/recalled library number will automatically be linked to the scene (shown in gray characters).

- ⚠ If there is not even one vacant library of the corresponding type, the AUTO STORE button will be masked, and cannot be clicked. In this case, the library number field will indicate "--" and the title field will indicate "--DATA FULL--".



- You can click the MANUAL STORE button and specify the store-destination unit, patch, and name as in previous versions.
- For libraries that require you to specify the store-destination, yellow "??" symbols will be displayed above the MANUAL STORE button.
- If the unit, patch, or name has been changed, the libraries will not be overwritten; a new library number will be selected automatically for storing, even when overwriting a previously-stored scene. This prevents the auto store operation from affecting other scenes in case a library is linked from more than one scene. If you want your changes to be reflected by all scenes that link to that library, click the MANUAL STORE button and perform the store operation as in previous versions, or edit each library directly.



## Using Auto Store from the [STORE] switch

Here's how to execute the auto store function simply by operating the SCENE MEMORY block [STORE] switch.

1. Access the UTILITY function PREFERENCE screen.
2. For the USE STORE SW ON PANEL FOR AUTO STORE field, click the ON/OFF button to turn it ON.



3. To execute the auto store function, press the SCENE MEMORY block [STORE] switch twice.

The first time you press the [STORE] switch, the SCENE STORE popup window will appear. The second time you press it, auto store will be executed. (The result is the same as clicking the AUTO STORE button.)

## Global Paste function

The settings of a desired channel or desired parameter in the current scene can now be copied and pasted into one or more scenes in scene memory. This is called the Global Paste function. It provides a convenient way for changes in the current scene to be reflected in previously-stored scenes

### GLOBAL PASTE screen

The GLOBAL PASTE screen has been added to the SCENE function.

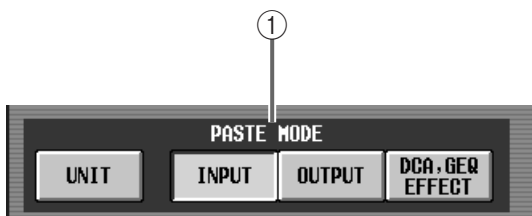
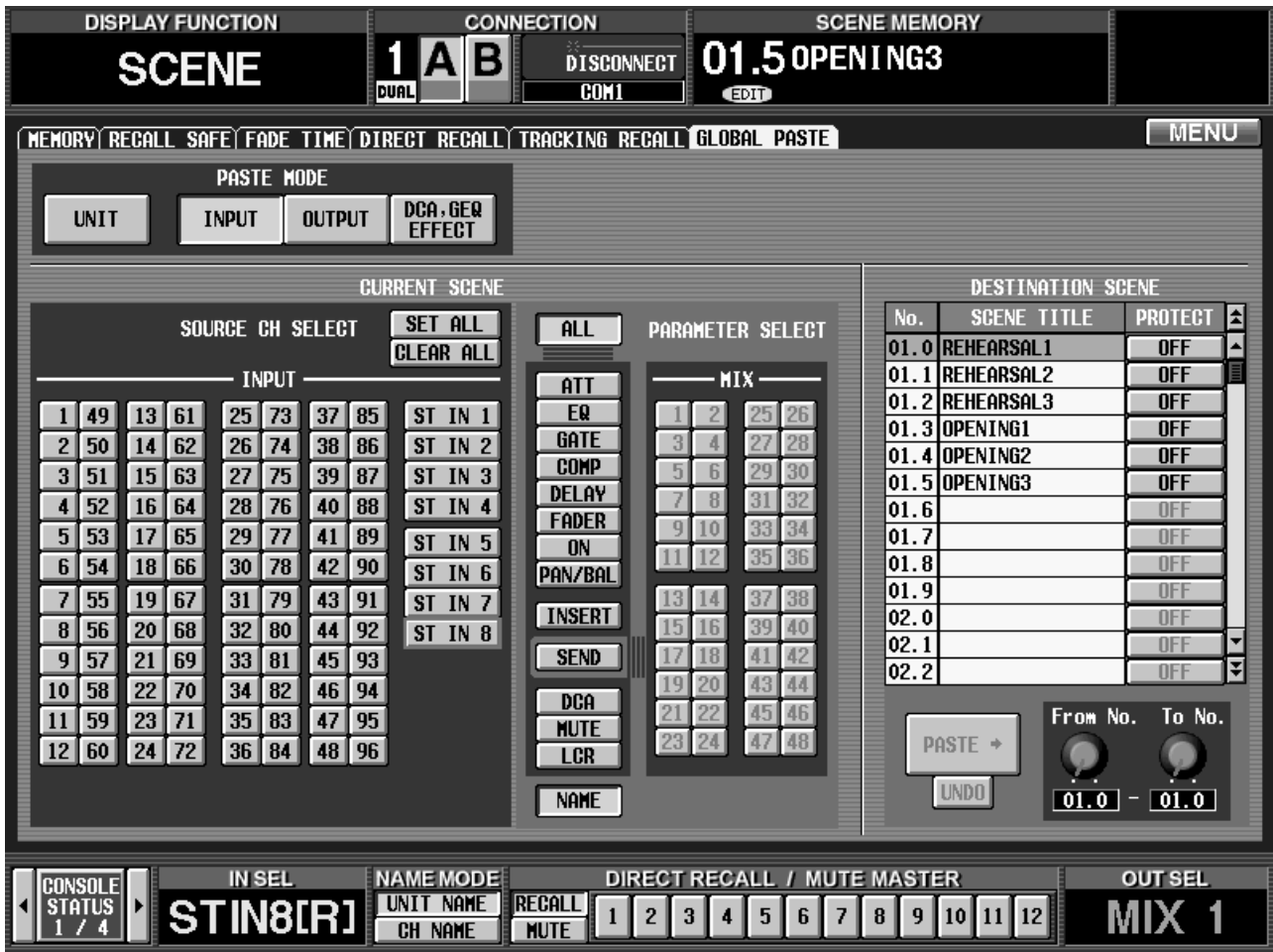

① **PASTE MODE**

Here you can select one of the following as the item(s) to be pasted.

- **UNIT**.....Settings of an input unit assigned to an input channel
- **INPUT** .....Parameters of an input channel

- **OUTPUT** .....Parameters of an output channel
- **DCA, GEQ, EFFECT** ..DCA level and mute on/off settings, GEQ settings, EFFECT settings

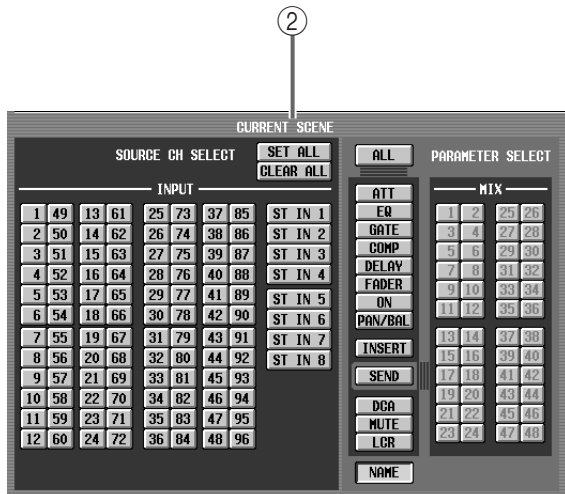

### ② CURRENT SCENE

Here you can select the channel(s) and parameter(s) of the current scene whose data will be copied. The items that will be displayed here will depend on the PASTE MODE (①) selection.

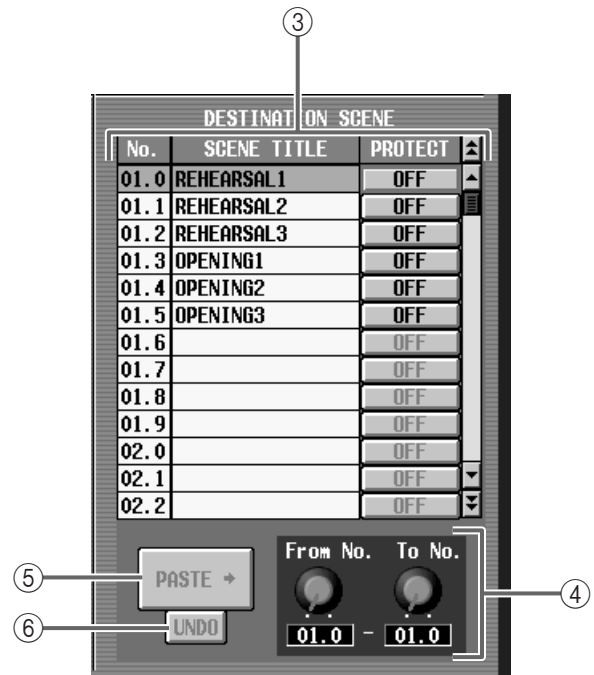

### ③ DESTINATION SCENE

For each scene stored in memory, this area indicates the scene number, title, and protect on/off setting. Click the number/title field to select the paste-destination scene(s). (The currently selected scene is displayed in blue.) You can also switch protect on/off from this screen.



- By holding down the [SHIFT] key and clicking a number/title in the scene list, you can select two or more consecutive scenes.
- A maximum of 100 scenes can be selected simultaneously.

### ④ From No./To No. (From number / To number)

When selecting two or more consecutive scenes as the paste-destination, these knobs specify the starting and ending numbers.

### ⑤ PASTE

Click this button to execute the paste.

### ⑥ UNDO

Click this button to undo the previously-executed paste operation.

- ⚠ If you recall another scene or sort the scene memories after executing paste, the Undo function will no longer be available.

## Using the Global Paste function

1. Access the SCENE function GLOBAL PASTE screen.
2. Use the PASTE MODE buttons to select the type of item that you want to paste.
3. In the CURRENT SCENE section, select the channel(s) or parameter(s) that you want to copy. The items displayed in the CURRENT SCENE area will depend on the selection of the PASTE MODE (1) area.

• When PASTE MODE = INPUT

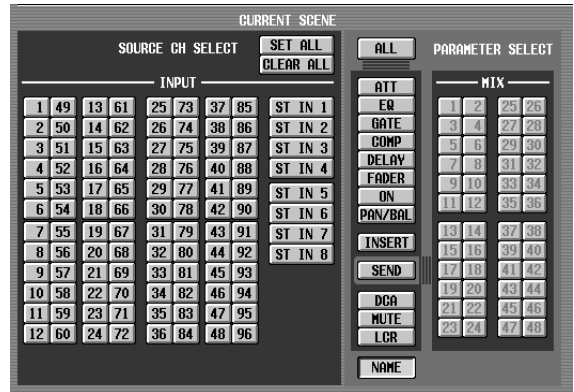

Use the SOURCE CH SELECT area to select the input channel(s), and the PARAMETER SELECT area to select the parameter(s).

You can select the following parameters.

- ALL.....All parameters except NAME
- ATT.....Attenuator
- EQ.....EQ function settings
- GATE.....GATE function settings
- COMP.....COMP function settings
- DELAY.....DELAY function settings
- FADER.....Fader level
- ON.....[ON] switch on/off status
- PAN/BAL.....Pan/balance settings
- INSERT.....Insert on/off status and insertion point
- SEND.....Send level to a specified MIX bus
- DCA.....Associated DCA group
- MUTE.....Associated mute group
- LCR.....LCR screen settings
- NAME.....NAME of the input channel

If you turn on the SEND button, use the buttons (1–48) of the MIX field to select the applicable MIX bus.



If you click the SET ALL button, all items will be selected. If you click the CLEAR ALL button, the selection will be cleared for all items. These buttons will function in the same way regardless of the PASTE MODE.

• When PASTE MODE = UNIT

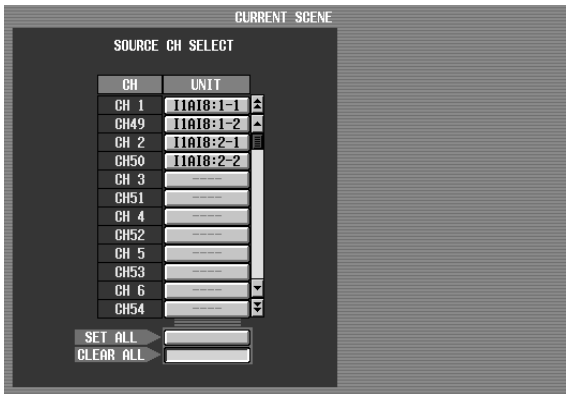

Click a button in the UNIT field to select the unit from which data will be copied.

- ⚠ If the source unit is a different type than the destination unit, no parameters will be copied.
- Even if SET ALL is selected, unpatched units will not be pasted.

• When PASTE MODE = OUTPUT

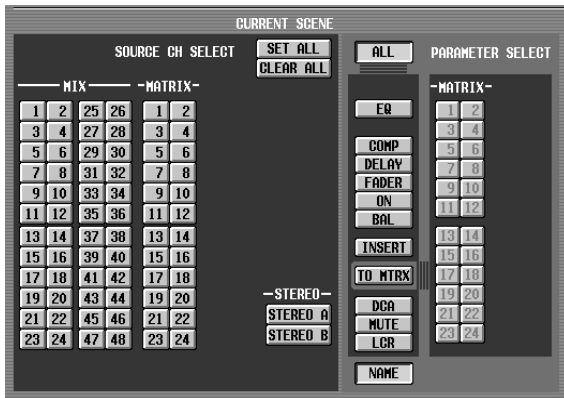

Use the SOURCE CH SELECT area to select the output channel(s), and the PARAMETER SELECT area to select the parameter(s).

You can select the following parameters.

- **ALL**..... All parameters except NAME
- **EQ** ..... EQ function settings
- **COMP** ..... COMP function settings
- **DELAY** ..... DELAY function settings
- **FADER** ..... Fader level
- **ON**..... [ON] switch on/off status
- **BAL** ..... Balance settings
- **INSERT** ..... Insert on/off status and insertion point
- **TO MTRX**..... Send level to a specified MATRIX bus
- **DCA** ..... Associated DCA group
- **MUTE** ..... Associated mute group
- **LCR** ..... LCR screen settings
- **NAME** ..... NAME of the output channel

If you turn on the TO MTRX button, use the buttons (1–24) of the MATRIX field to select the applicable MATRIX bus.



If you click the SET ALL button, all items will be selected. If you click the CLEAR ALL button, the selection will be cleared for all items. These buttons will function in the same way regardless of the PASTE MODE.

• When PASTE MODE = DCA, GEQ, EFFECT

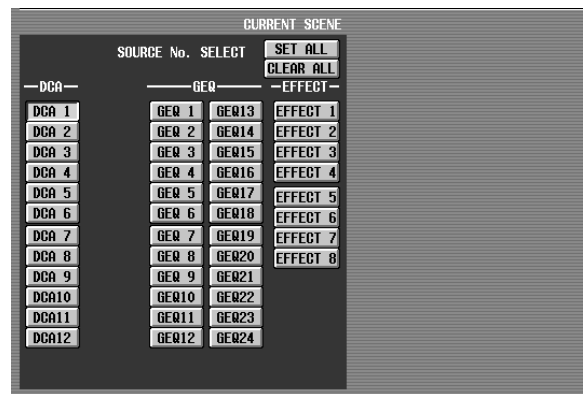

Use the SOURCE No. SELECT area to select the DCA group (DCA 1–12), GEQ (GEQ 1–24), and/or internal effect (EFFECT 1–8) that will be copied.



If you click the SET ALL button, all items will be selected. If you click the CLEAR ALL button, the selection will be cleared for all items. These buttons will function in the same way regardless of the PASTE MODE.

4. In the DESTINATION SCENE area, select the scene to which the data will be pasted.

To select an individual scene, click the number/title field in the scene list.

To select two or more consecutive scenes, use the From No. / To No. knobs to specify the starting and ending locations.

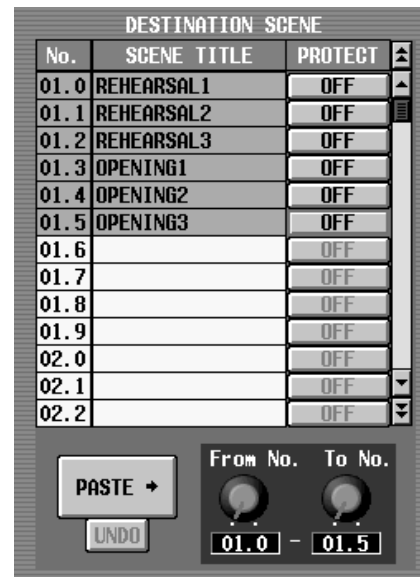

You can also select two or more scenes by holding down the [SHIFT] key and clicking the number/title fields of separate locations.



A maximum of 100 scenes can be selected simultaneously.

**5. Click the PASTE button.**

The selected item(s) of the current scene will be pasted to the scene(s) in memory.

- ⚠ • If PASTE MODE = UNIT, unit libraries that are linked to the selected scene will automatically be found and pasted.
- If PASTE MODE = INPUT/OUTPUT and the pasted parameter is NAME, the name library linked to the selected scene will be found and pasted.
- Be aware that if a library is linked from a different scene, the paste operation may cause the library to be overwritten.

⚠ If the parameters differ between the copy-source and paste-destination scenes, the data be handled as follows according to the type of parameter.

**■ When Paste Mode = UNIT**

- If the type of unit differs between the copy-source and paste-destination, no parameters of any cards (all eight slots) installed in that unit will be copied.
- Even if the copy-source and paste-destination units are the same type, if the type of installed card is different, the parameters for that card will not be pasted.

**■ When Paste Mode = INPUT**

- If the copy-source and paste-destination have differing MIX bus settings (paired or FIX/VARI), mix send-related parameters will not be pasted.
- If the states (pan or balance) of the copy-source and paste-destination differ, the pan/balance setting and the send level to the MIX bus will not be pasted.
- If the states (pairing or LR-Mono) of the copy-source and paste-destination differ, the parameters will be pasted only if both L and R channels are selected and ALL is selected.
- Some pairing-related parameters will be pasted only if both L and R channels are selected.
- If PAN LINK is on for the paste-destination, PAN LINK will be turned off if other than ALL is selected and either SEND or PAN/BAL is selected.
- DCA group parameters will be pasted only to groups to which no output channel is assigned.

**■ When Paste Mode = OUTPUT**

- If MATRIX pairing differs between the copy-source and paste-destination, mix send-related parameters will not be pasted.
- If MIX or MATRIX pairing differs between the copy-source and paste-destination, parameters will be pasted only if both L and R channels are selected and ALL is selected.

- If MIX pairing was changed as a result of paste, the send levels to that MIX will be changed as follows.

Change in MIX pair	MIX TYPE	PAN LINK	CH PAIR	PAN MODE	Send Level setting
Pair → Mono	Fix	—	—	—	Odd and Even set to nominal
	Vari	—	—	—	Even (Level) copied to Odd (Pan)
Mono → Pair	Fix	On	—	—	Odd and Even set to nominal
					ChPan copied to Odd (Pan), Even set to the larger of the two MIX settings
	Vari	Off	Mono	—	Odd (Pan) set to center, Even set to the larger of the two MIX settings
					Pair
			Balance	Odd (Pan) set to center, Even set to the larger of the two MIX settings	

- If MATRIX pairing was changed as a result of paste, the send levels to that MATRIX will be changed as follows. (However, the MIX selected for pasting is excepted.)

Change in MATRIX pair	MIX pair	Send Level setting
Pair → Mono	—	Even (Level) copied to Odd (Pan)
Mono → Pair	Mono	Odd (Pan) set to Center, Even set to the larger of the two MTRX settings
	Pair	Odd (Pan) set to left and right, Even set to the larger of the two MTRX settings

- Some pairing-related parameters will be pasted only if both L and R channels are selected.
- DCA group parameters will be pasted only to groups to which input channels are not assigned. (For MATRIX and STEREO A/B, only MUTE.)

**■ When Paste Mode = DCA, GEQ, EFFECT**

- If GEQ LINK is turned off in the copy-source (the current scene), and GEQ LINK is turned on in the paste-destination, GEQ LINK will be turned off in the paste-destination, and the GEQ parameters will be pasted.

## Parameter control via CONTROL CHANGE and NRPN

In PM1D system software V1.5, parameters can be transmitted to an external device as MIDI continuously-variable data when you perform an operation (other than Scene Recall) on the console (CS1D). Similarly, continuously-variable data received from an external device can remotely control internal parameters. For example, you can use an external MIDI sequencer or PC-based sequencer software to record parameter changes in realtime, and reproduce these movements whenever desired.

The PM1D (version 1.5) can receive and transmit two types of MIDI message for this purpose: Control Change messages and NRPN (Non Registered Parameter Number) messages.

<b>Control change</b>	<b>CONTROL CHANGE</b>	You can assign parameters to control change numbers. However, there are limitations on the type of parameters that can be assigned.
	<b>NRPN</b>	The parameter assignments are pre-determined. These assignments cannot be changed.

### MIDI CTRL CHANGE screen

Settings for MIDI CONTROL CHANGE and NRPN messages are made in the MIDI/GPI/TC function MIDI CTRL CHANGE screen.

The screenshot shows the 'MIDI CTRL CHANGE' screen. At the top, it displays 'DISPLAY FUNCTION: MIDI/GPI/TC', 'CONNECTION: 1 A B DISCONNECT COM1', and 'SCENE MEMORY: 01.50 OPENING3'. Below this are tabs for 'MIDI PGM CHANGE', 'MIDI CTRL CHANGE', 'GPI', 'TC EVENT', 'FADER START', and 'MENU'.

The main area is split into two columns. The left column is titled 'MIDI SETUP' and contains the following settings:

- MIDI PORT:** Tx (CONSOLE 1, CONSOLE 2, ENGINE, OFF) and Rx (CONSOLE 1, CONSOLE 2, ENGINE, OFF).
- PROGRAM CHANGE:** Tx (OFF), Rx (OFF), MIDI MODE (MULTI, SINGLE, OMNI, BANK OFF), and ECHO.
- CONTROL CHANGE:** Tx (ON), Rx (ON), MIDI MODE (MULTI, SINGLE).
- NRPN:** Tx (OFF), Rx (OFF).

The right column is titled 'INITIALIZE' and contains a table:

CH	CTRL No.	CTRL CHANGE EVENT (+MIDI CH)
ALL	0	BANK SELECT (MSB)
ALL	1	CH 1 ON/OFF
ALL	2	NO ASSIGN
ALL	3	NO ASSIGN
ALL	4	NO ASSIGN
ALL	5	NO ASSIGN
ALL	6	DATA ENTRY (MSB)
ALL	7	NO ASSIGN
ALL	8	NO ASSIGN
ALL	9	NO ASSIGN
ALL	10	NO ASSIGN
ALL	11	NO ASSIGN
ALL	12	NO ASSIGN
ALL	13	NO ASSIGN
ALL	14	NO ASSIGN
ALL	15	NO ASSIGN
ALL	16	NO ASSIGN
ALL	17	NO ASSIGN

At the bottom, the status bar shows 'CONSOLE STATUS 1 / 4', 'IN SEL STIN7[R]', 'NAME MODE UNIT NAME CH NAME', 'DIRECT RECALL / MUTE MASTER' (1-12), and 'OUT SEL MIX 1'.

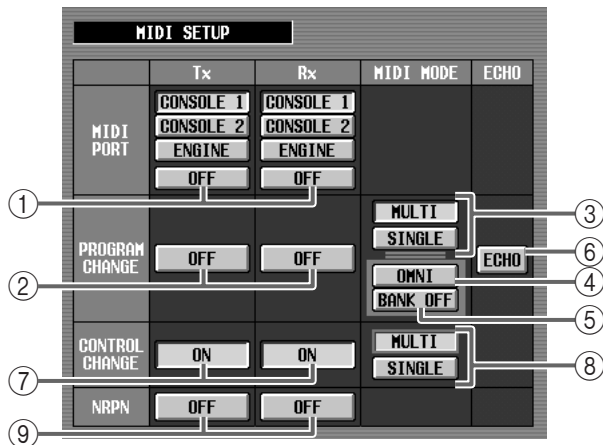

① **MIDI PORT Tx/Rx (MIDI transmit/receive port)**  
 Selects the MIDI port that will transmit MIDI messages (Tx) and the MIDI port that will receive MIDI messages (Rx). You can select the console or engine port.

- ⚠ • When using the PM1D system in Dual Console mode, you can select console 1 or 2.
- When using the PM1D system in Mirror mode, and the engine is selected, the MIDI port of the currently-enabled engine will be selected automatically. (This is an improvement from the previous version.)

② **PROGRAM CHANGE Tx/Rx (PROGRAM CHANGE transmission/reception)**  
 Switches PROGRAM CHANGE transmission (Tx) or reception (Rx) on/off.

③ **PROGRAM CHANGE MIDI MODE (PROGRAM CHANGE MIDI mode)**  
 As the PROGRAM CHANGE transmission/reception mode, you can select either Multi mode (use MIDI channels 1–16 for transmission and reception) or Single mode (use only a single MIDI channel for transmission and reception).

For details, refer to the CS1D Reference Manual (Software), page 30, item ③.

④ **OMNI**  
 If Single mode is selected, turning this button on will allow program change messages of all MIDI channels to be received. In Multi mode, this button has no effect.

⑤ **BANK ON/OFF (Bank select on/off)**  
 If Single mode is selected, turning this button on will allow bank select messages to be received, increasing the number of parameters that respond to program change messages. In Multi mode, this button has no effect.

⑥ **PROGRAM CHANGE ECHO (PROGRAM CHANGE echo output)**  
 If this button is on, program change messages received from the MIDI IN connector will be echoed from the MIDI OUT connector.



②–⑥ are identical to the functions of the same name in the MIDI PGM CHANGE screen of previous versions.

⑦ **CONTROL CHANGE Tx/Rx (CONTROL CHANGE transmission/reception)**

Switches CONTROL CHANGE transmission (Tx) or reception (Rx) on/off.

⑧ **CONTROL CHANGE MIDI MODE (CONTROL CHANGE MIDI mode)**

Selects one of the following as the CONTROL CHANGE transmission/reception mode.

• **MULTI (Multi mode)**

CONTROL CHANGE on MIDI channels 1–16 will be used simultaneously to control the event (parameter) assigned in the parameter list at the right side of the screen and the parameters of the fifteen NRPN numbers that follow it. When the console is used to edit the corresponding parameter or any parameter of the fifteen NRPN numbers that follow it, a CONTROL CHANGE message will be transmitted on MIDI channel 1–16.

• **SINGLE (Single mode)**

When a CONTROL CHANGE is received on the MIDI channel selected by the Rx knob (⑪), the parameter assigned in the parameter list at the right of the screen will be edited.

When the console is used to edit the corresponding parameter, a control change message will be transmitted on the MIDI channel selected by the Tx knob (⑩).

⑨ **NRPN Tx/Rx (NRPN transmission/reception)**

Switches NRPN transmission (Tx) or reception (Rx) on/off. This can be used simultaneously with CONTROL CHANGE transmission and reception. In this case, operation will be as follows.

• **CONTROL CHANGE / NRPN reception is on**

Parameters to which CONTROL CHANGE or NRPN reception (or both) is assigned will respond.

• **CONTROL CHANGE / NRPN transmission is on**

When you operate a parameter to which either CONTROL CHANGE or NRPN (not both) is assigned, the corresponding message will be transmitted.

When you operate a parameter to which both CONTROL CHANGE and NRPN are assigned, only the CONTROL CHANGE message will be transmitted.



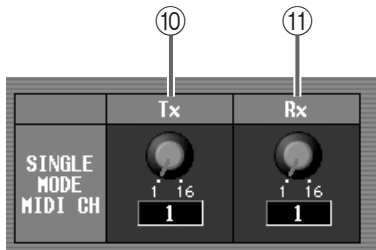

⑩ Tx knob

If Single mode is selected as the MIDI mode for PROGRAM CHANGE / CONTROL CHANGE, this knob selects the MIDI channel on which messages will be transmitted. In Multi mode, this parameter has no effect.

⑪ Rx knob

If Single mode is selected as the MIDI mode for PROGRAM CHANGE / CONTROL CHANGE, this knob selects the MIDI channel on which messages will be received. In Multi mode, this parameter has no effect.

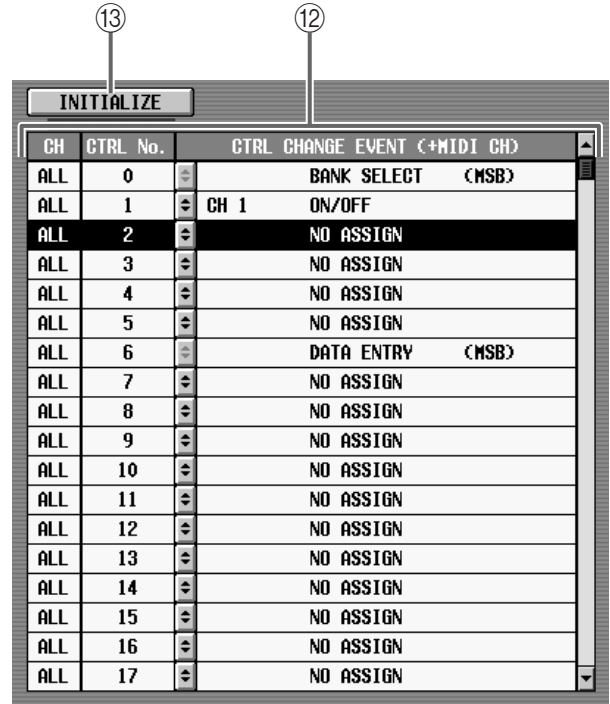

⑫ CONTROL CHANGE event list

From the left, the columns indicate the MIDI channel, control number, and the assigned event (parameter). You can click the button to open the MIDI CTRL CHANGE popup window and select a parameter.



In the CONTROL CHANGE event list, the MIDI channel column will indicate “ALL” if Multi mode is selected, or “--” if Single mode is selected.

⑬ INITIALIZE

Initializes the control number parameter assignments to their default state.



In version 1.5, the content of items ①—⑪ of the MIDI PROGRAM CHANGE screen has been changed in the same way.

## Using CONTROL CHANGE / NRPN messages to record/play parameter changes

Here's how parameter operations on the console (CS1D) can be recorded on a MIDI sequencer or other external device, and their changes played back.

1. **Connect the MIDI OUT connector of your MIDI sequencer (PC-based sequencer software) to the MIDI IN connector of the console or engine, and connect the MIDI IN connector of your MIDI sequencer to the MIDI OUT connector of the console or engine.**

The following diagram shows an example of connecting the console with PC-based sequencer software.

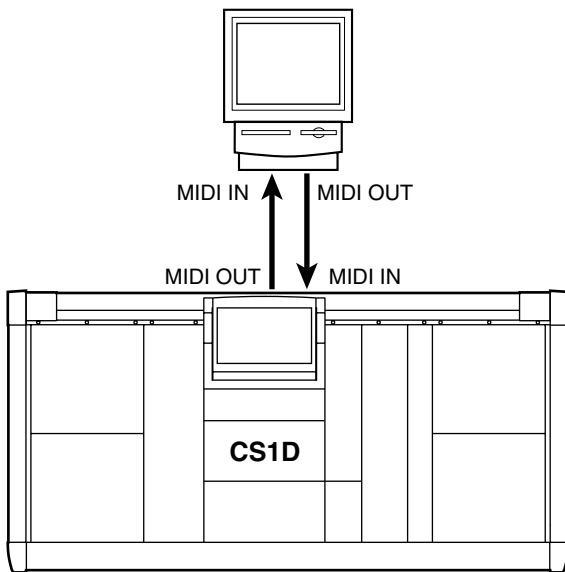

When recording operations of the console, make sure that the "MIDI echo" or "MIDI thru" setting (a function by which messages received at the MIDI IN connector are re-transmitted from the MIDI OUT connector) of your MIDI sequencer is turned off.

2. **Access the MIDI/GPI/TC function MIDI CTRL CHANGE screen, and set the MIDI PORT field to specify the MIDI port that will receive MIDI messages.**



The MIDI port selection can be made either from the MIDI PGM CHANGE screen or the MIDI CTRL CHANGE screen.

3. **According to the type of message that you want to transmit and receive, turn on either the CONTROL CHANGE Tx/Rx buttons or the NRPN Tx/Rx buttons.**

We recommend that you normally turn on the Tx/Rx buttons for either CONTROL CHANGE or NRPN, not both.

If you turned on the CONTROL CHANGE Tx/Rx buttons, proceed to step 4.

If you turned on the NRPN Tx/Rx buttons, proceed to step 9.

4. **Use the CONTROL CHANGE MIDI MODE buttons to select either Multi mode or Single mode.** Depending on the mode you select, operation will differ as follows.

- **Single mode**

For both transmission and reception, messages will be transferred using only a single MIDI channel. In this mode if you assign the level (fader) of input channel 1 to CONTROL CHANGE #1, operating the fader of input channel 1 will transmit CONTROL CHANGE #1 on the Tx channel. If CONTROL CHANGE #1 on the Rx channel is received, the level of input channel 1 will change.

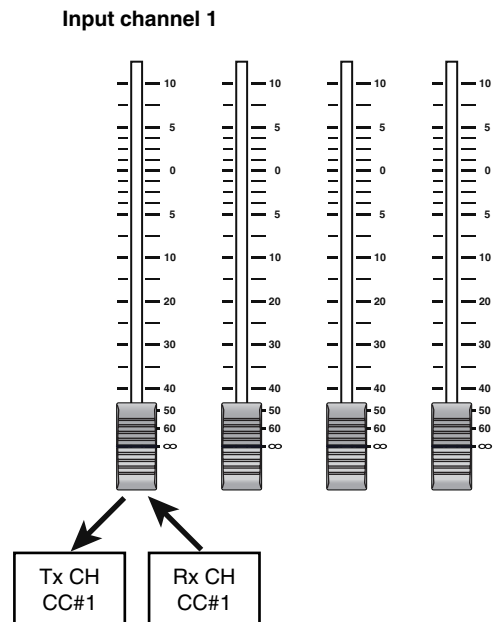

• **Multi mode**

Up to sixteen MIDI channels will be used simultaneously. (The CH column of the parameter list will indicate “ALL.”) In this mode if you assign the level (fader) of input channel 1 to CONTROL CHANGE #1, the respective MIDI channels will be assigned automatically to input channels 2–16. In this state, operating the faders of input channels 1–16 will transmit CONTROL CHANGE #1 on MIDI channels 1–16. If a CONTROL CHANGE #1 message is received on a MIDI channel 1–16, the level of the corresponding input channel 1–16 will change.

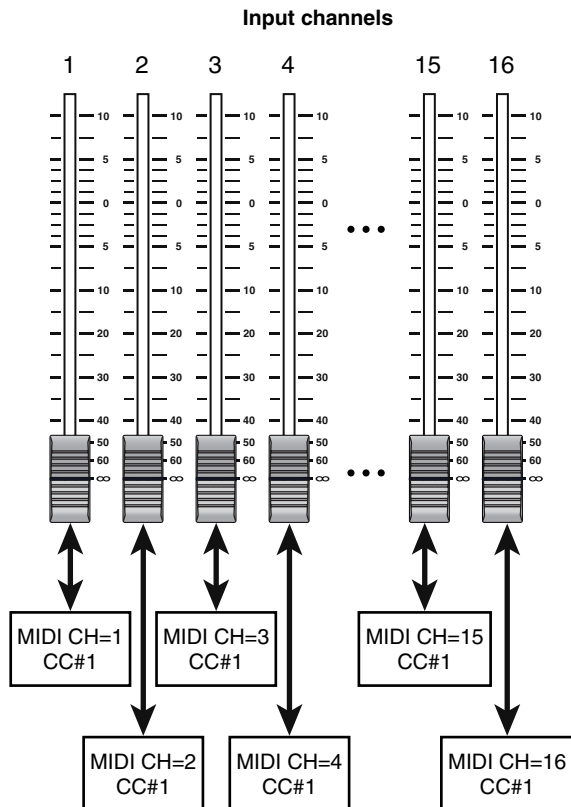

The parameters that are automatically assigned to MIDI channels 1–16 will be “the NRPN# of the assigned parameter” +1 to 15. For details on the NRPN numbers, refer to page 94.

5. If Single mode is selected, use the Tx knob and Rx knob to specify the MIDI transmit channel and receive channel.
6. If you want to change the parameter that is assigned to each control number, click the button in the parameter list.

The MIDI CTRL CHANGE popup window will appear, allowing you to assign a parameter to the CONTROL CHANGE.



7. Select the parameter group in the MODE field, select the type of parameter and channel number (or DCA group, effect, GEQ number) in the PARAMETER field, and click the OK button. If you selected Multi mode as the MIDI mode for CONTROL CHANGE, up to sixteen MIDI channels will automatically be assigned for the selected parameter; the selected number = MIDI channel 1, selected number +1 = MIDI channel 2, selected number +2 = MIDI channel 3, and so on.



For details on the parameters that can be selected for each group, refer to page 94.

8. In the same way, assign parameters for other control numbers. Control numbers 0–119 may be used. However, parameters cannot be assigned to the following control numbers which used for special purposes.

CONTROL CHANGE#	Function
0	Bank select (MSB)
6	Data entry (MSB)
31/2	Bank select (LSB)
38	Data entry (LSB)
96	Data increment
97	Data decrement
98	NRPN (LSB)
99	NRPN (MSB)
100	RPN (LSB)
101	RPN (MSB)

9. Put your MIDI sequencer in record mode, and operate the parameters you assigned. The corresponding CONTROL CHANGE / NRPN messages will be transmitted from the MIDI OUT connector, and recorded on your sequencer.
10. When you have finished recording, play back your sequencer. The parameter changes will be reproduced.

## Manual Fading function

When recalling a scene for which a fade time is specified, you can use the Manual Fading function, which allows you to control fading forward or backward by turning the [DATA] encoder.

### New functions in the FADE TIME screen

So that you can use the Manual Fading function, the following items have been added to the SCENE function FADE TIME screen.



#### ① MANUAL FADING

Switches manual fading on/off. While auto fade is being executed, you can move the cursor to this button and press the [ENTER] switch to switch immediately to manual fading. Alternatively, if you turn this button on beforehand, you will be able to manually control the fade from the beginning when you recall a scene for which a fade time is specified.

#### ② PROGRESS

If the MANUAL FADING button (①) is on, you can move the cursor to this knob and turn the [DATA] encoder to manually fade between 0% (fader values before recall) – 100% (fader values reached after recall). At this time, the fading progress (as a percentage) is shown in the numerical box below the knob.

### Using Manual Fading (1)

Here's how to switch to manual fading while auto fading is being executed.

1. Access the SCENE function FADE TIME screen.
2. Move the cursor to the MANUAL FADING button.
3. Using the SCENE MEMORY section of the panel, recall a scene for which auto fading has been specified.
4. When auto fading begins, press the [ENTER] switch.  
Operation will switch from auto fading to manual fading, and the cursor will automatically move to the PROGRESS knob.

### 5. Turn the [DATA] encoder toward the right.

Fading will progress as you turn the encoder. If necessary, you can turn the encoder toward the left to reverse the fade.

#### Fader settings before scene recall

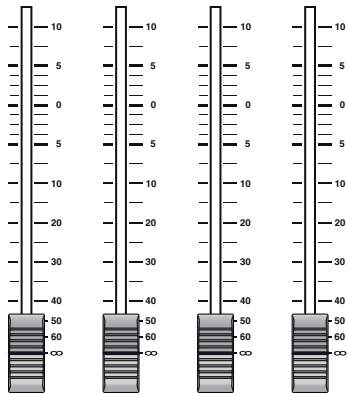

PROGRESS=0%

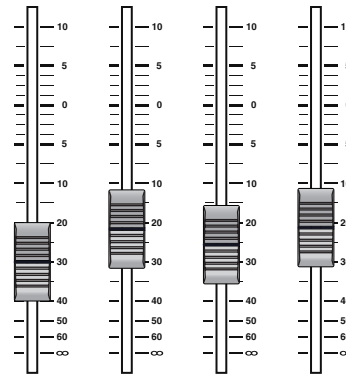

PROGRESS=50%



#### Fader settings after scene recall

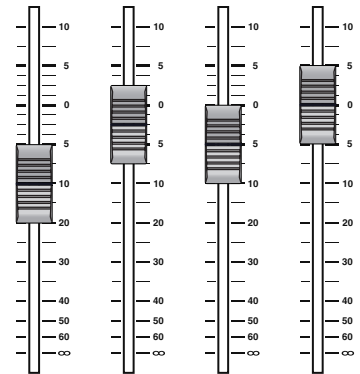

PROGRESS=100%

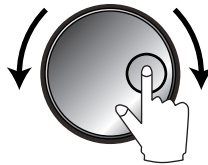

If one minute elapses during manual fading without the [DATA] encoder being operated, the MANUAL FADING button will automatically be turned off, and auto fading will begin.

Also, auto fading will begin immediately if the MANUAL FADING button is switched off.



By assigning a USER DEFINE switch (or GPI IN) to the MANUAL FADE ON function, you can use that USER DEFINE switch (or an external switch connected to the GPI connector) to switch between manual fading and auto fading. Even if a different screen is currently displayed, the FADE TIME screen will immediately be recalled, and the cursor will move to the PROGRESS knob.

- ⚠ It is not possible to modify the FADE TIME parameter while manual fading is being performed.
- Manual fading will be cancelled if the FADING button is switched to “DISABLE,” if the buttons in the FADING CH SELECT section are all turned off, or if a fader or pan value is edited either manually or from an external controller such as MIDI.

#### [PM1D Manager]

- ⚠ In PM1D Manager, the FADE TIME parameter can be edited even while manual fading is being performed. However, the FADE TIME parameter will not be reflected until the currently-executed fading has ended.

## Using Manual Fading (2)

---

Here's how you can enable manual fading beforehand, and perform manual fading from the beginning when you recall a scene.

1. **Access the SCENE function FADE TIME screen.**
2. **Move the cursor to the MANUAL FADING button and press the [ENTER] switch.**  
The MANUAL FADING button will turn on.
3. **Using the SCENE MEMORY section of the panel, recall a scene for which auto fading has been specified.**  
When the scene is recalled, manual fading will be enabled.
4. **Move the cursor to the PROGRESS knob, and turn the [DATA] encoder to control the fading.**

If one minute elapses during manual fading without the PROGRESS knob being operated, the MANUAL FADING button will automatically be turned off, and auto fading will begin.

Also, if the PROGRESS knob value stays at 100% for five seconds, the MANUAL FADING button will be turned off, and fading will end.

If you turn the MANUAL FADING button off, auto fading will begin immediately.



---

If you assign a USER DEFINE switch (or GPI IN) to the MANUAL FADE ON function, you will be able to switch instantly to the FADE TIME screen from any other screen.

---

## Unit name

Now you can assign a unit name to each input/output unit and to each port of a card.

### UNIT NAME screen

The UNIT NAME screen has been added to the SYS/W.CLOCK function, allowing you to assign a name to each unit and each port of a card.

**DISPLAY FUNCTION** SYS/W.CLOCK    **CONNECTION** 1 A B    **SCENE MEMORY** 01.5 OPENING3

DISCONNECT COM1    EDIT

SYSTEM CONNECTION DUAL CONSOLE CASCADE INPUT UNIT OUTPUT UNIT WORD CLOCK DITHER UNIT NAME MENU

UNIT LIBRARY ▾

**UNIT SELECT**

IN 1	OUT 1
IN 2	OUT 2
IN 3	OUT 3
IN 4	OUT 4
IN 5	OUT 5
IN 6	OUT 6
IN 7	
IN 8	
IN 9	
IN10	

UNIT TYPE: A18  
UNIT NAME: -----

SLOT	CARD	TYPE	CH	SHORT
1	LMY2-ML	1A	----	
1	LMY2-ML	1B	----	
1	LMY2-ML	2A	----	
1	LMY2-ML	2B	----	
2	LMY2-ML	1A	----	
2	LMY2-ML	1B	----	
2	LMY2-ML	2A	----	
2	LMY2-ML	2B	----	
3	LMY2-ML	1A	----	
3	LMY2-ML	1B	----	
3	LMY2-ML	2A	----	
3	LMY2-ML	2B	----	
4	LMY2-ML	1A	----	
4	LMY2-ML	1B	----	
4	LMY2-ML	2A	----	
4	LMY2-ML	2B	----	
5	LMY2-ML	1A	----	
5	LMY2-ML	1B	----	
5	LMY2-ML	2A	----	
5	LMY2-ML	2B	----	

	SHORT	LONG		SHORT	LONG
1	Kick	Kick	9	Tom1	Tom 1
2	Sn	Snare	10	Tom2	Tom 2
3	Sn. T	SnareTop	11	Tom3	Tom 3
4	Sn. B	SnareBtm	12	Tom4	Tom 4
5	P. Sn	Picco. Sn	13	Tom5	Tom 5
6	HH	Hi-Hat	14	Tom6	Tom 6
7			15		
8			16		

ENTER

PASTE COPY

INS DEL CLEAR

SHIFT LOCK SPACE

CONSOLE STATUS 1 / 4    IN SEL STIN8[R]    NAME MODE UNIT NAME CH NAME    DIRECT RECALL / MUTE MASTER 1 2 3 4 5 6 7 8 9 10 11 12    OUT SEL MIX 1

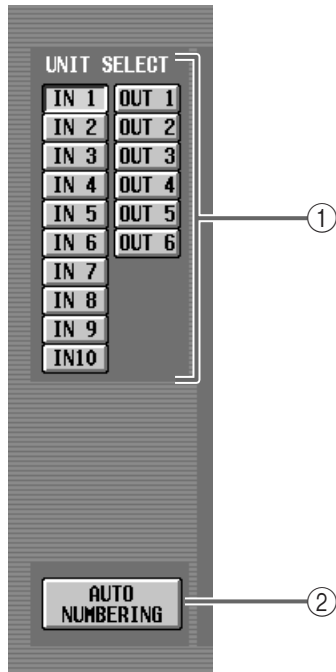

- ① **UNIT SELECT**  
Use these buttons to select the unit (IN 1–10, OUT 1–6) that you want to name.
- ② **AUTO NUMBERING**  
When you click this button, each INPUT UNIT / OUTPUT UNIT will be automatically assigned consecutive numbers.

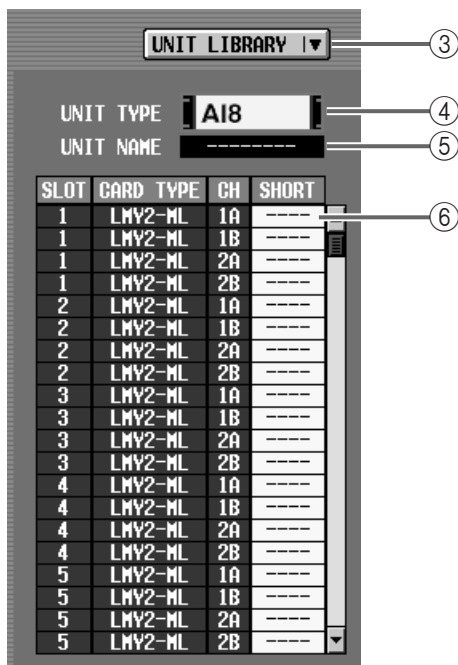

- ③ **UNIT LIBRARY**  
This button opens the UNIT LIBRARY window, allowing you to save/load unit settings as library data.

⚠ Unit name data is saved in the unit library, not in the name library.

- ④ **UNIT TYPE**  
Indicates the type of unit that is selected in UNIT SELECT (①).



By clicking this you can jump to the corresponding page of the INPUT UNIT screen or OUTPUT UNIT screen.

- ⑤ **UNIT NAME**  
Indicates the name of the unit that is selected in UNIT SELECT (①). You can also click this field and use the text box (⑧) and character palette (⑨) to assign a name to the unit.
- ⑥ **Name list**  
This column displays the name of each port of the cards installed in the currently selected unit.



- ⑦ **Template name list**  
Frequently-used names and abbreviations can be registered in this list as template names. This list is common to the template name list in the IN PATCH/OUT PATCH function NAME screen. Changes made to one will be reflected in the other.
- ⑧ **Text box**  
This text box lets you edit or newly create a name in the name list (⑥) or template name list (⑦).
- ⑨ **Character palette**  
This palette lets you input characters, numerals, and symbols into the text box. For details on operation, refer to the “CS1D Operation Manual (Basic Operation)” section “Assigning a name” (→p.20).



## Naming a unit/port

1. Access the SYS/W.CLOCK function UNIT NAME screen.
2. Click a UNIT SELECT button to select a unit.
3. To assign a name to the unit itself, click the UNIT NAME field.  
The field will change color to light blue, indicating that it can now be edited.
4. Use the character palette or an external keyboard to input a name of up to eight characters into the text box, and click the ENTER button in the screen.  
The unit name will be finalized.



Alternatively, you can use a template name instead of inputting the name. For details on using template names, refer to “CS1D Reference Manual (Software)” page 129.

5. To assign a name to each port of a card installed in the unit, click the name field in the name list.  
The field will change color to light blue, indicating that it can now be edited.
6. Use the character palette or an external keyboard to input a name of up to four characters into the text box, and click the ENTER button in the screen.
7. Assign names to other ports in the same way.
8. If you want ports to be numbered consecutively, click the AUTO NUMBERING button.  
A popup window will ask you to confirm the auto numbering operation.
9. Click the OK button.  
Consecutive numbers will automatically be assigned to all usable ports of that unit.

SLOT	CARD TYPE	CH	SHORT
1	LMY2-ML	1A	1
1	LMY2-ML	1B	1
1	LMY2-ML	2A	2
1	LMY2-ML	2B	2
2	LMY2-ML	1A	3
2	LMY2-ML	1B	3
2	LMY2-ML	2A	4
2	LMY2-ML	2B	4
3	LMY2-ML	1A	5
3	LMY2-ML	1B	5
3	LMY2-ML	2A	6
3	LMY2-ML	2B	6
4	LMY2-ML	1A	7
4	LMY2-ML	1B	7
4	LMY2-ML	2A	8
4	LMY2-ML	2B	8
5	LMY2-ML	1A	9
5	LMY2-ML	1B	9
5	LMY2-ML	2A	10
5	LMY2-ML	2B	10

⚠ If an LMY2-ML mic/line input card is installed in the input unit, the same number will be assigned to jacks A and B of the same port.

10. If you want to display the name of the port assigned to that channel, rather than the short name of the input channel shown in the screen, click the UNIT NAME button located at the bottom of the screen.

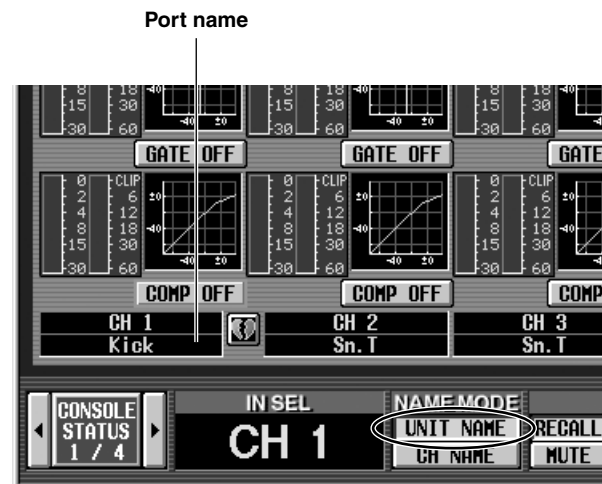

## Matrix send shortcuts

In the previous version, the send level of a signal sent from a MIX channel / STEREO A/B channel to a MATRIX bus could be controlled only from the screen. However, version 1.5 provides a shortcut that lets you use panel encoders to control this.

There is a shortcut for controlling the send level from a single MIX channel to each of the MATRIX buses, and another shortcut for controlling the send level from each of the MIX channels to a single MATRIX bus.

### ■ Single MIX channel → each MATRIX bus

In the MIX OUTPUT block of the panel, press and hold the [SEL] switch of the MIX channel that is sending the signal.

After you have held down the [SEL] switch for a time, the MATRIX OUTPUT block MATRIX [NAME] indicator will alternately display “SEND” and the short name of MATRIX channel.

In the case of a paired MATRIX channel, the [NAME] indicator of the odd-numbered channel will alternately display “PAN” and the short name of that MATRIX channel.

While you continue to hold down the switch, use the MATRIX OUTPUT block MATRIX [LEVEL/BAL] encoders to adjust the send level or pan from the selected MIX channel to each of the MATRIX buses. (The send level value is shown by the LEDs surrounding the MATRIX [LEVEL/BAL] encoder.)

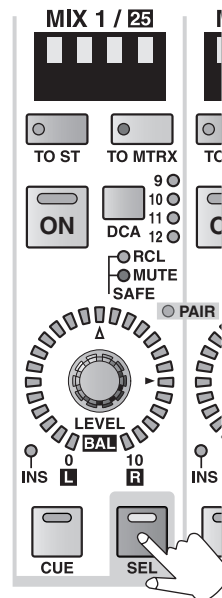

MIX OUTPUT block

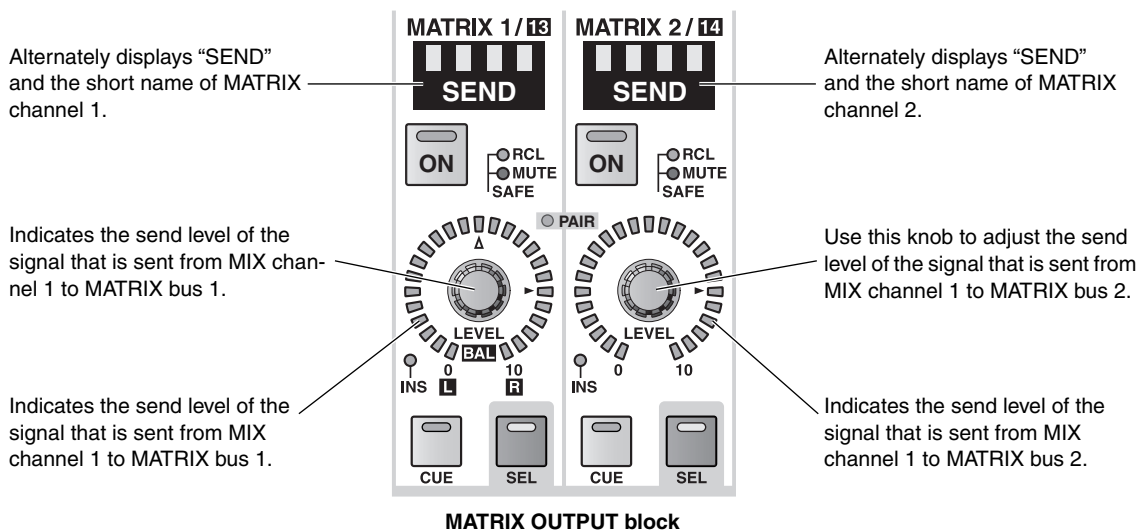

MATRIX OUTPUT block



In the same way, you can hold down the STEREO OUTPUT block STEREO A/B [SEL] switch and use the MATRIX [LEVEL/BAL] encoders to adjust the send level of the signal from the STEREO A/B channel to each MATRIX bus.



If you are using the controls of the MIX OUTPUT block to edit effect parameters, the above shortcut cannot be used. However, you can still use the shortcut of holding down the STEREO A/B [SEL] switch.

■ Each MIX channel → single MATRIX bus

In the MATRIX OUTPUT block of the panel, press and hold the [SEL] switch of the MATRIX channel that is sending the signal.

After you have held down the [SEL] switch for a time, the MIX OUTPUT block MIX [NAME] indicator will alternately display “SEND” and the short name of the MIX channel.

While you continue to hold down the switch, use the MIX OUTPUT block MIX [LEVEL/BAL] encoders to adjust the send level or pan from each MIX channel to the selected MATRIX bus. (The send level value is shown by the LEDs surrounding the MIX [LEVEL/BAL] encoder.)

In the case of a paired MATRIX channel, pressing the [SEL] switch of the odd-numbered channel will cause the [NAME] indicator of the MIX channel to alternately display “PAN” and the short name, allowing you to set the pan.

Pressing the [SEL] switch of the even-numbered channel will cause the [NAME] indicator of the MIX channel to display “SEND,” allowing you to set the send level.

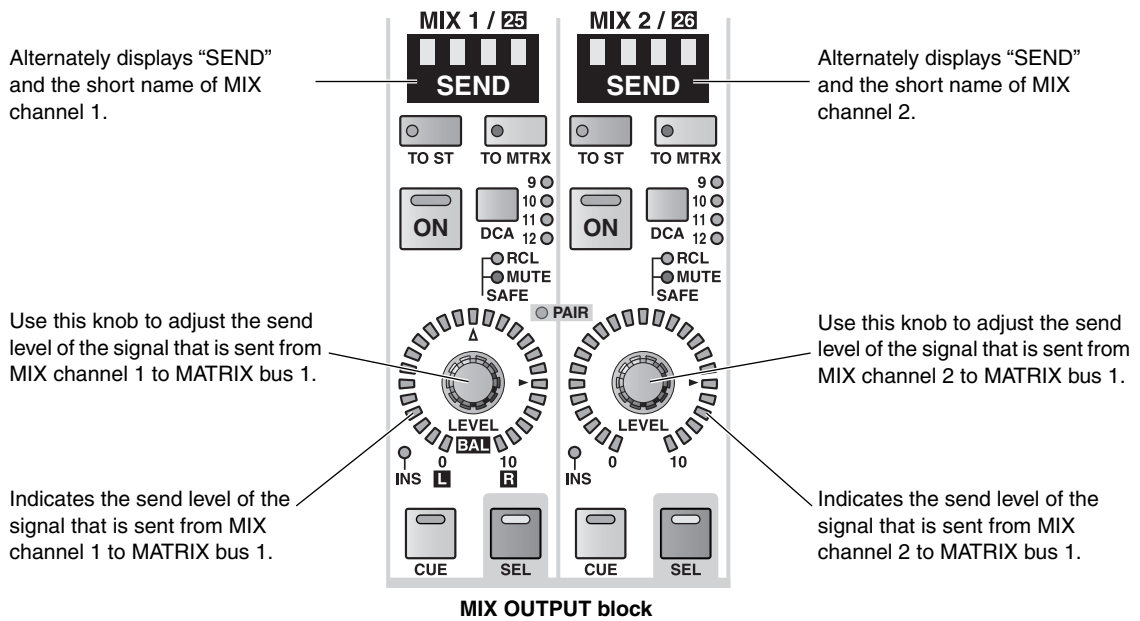
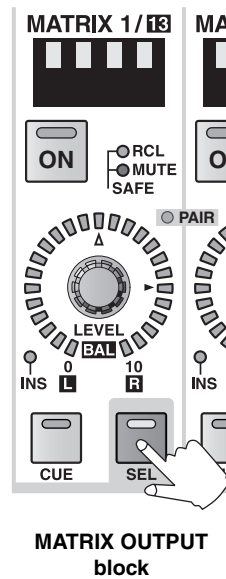

⚠ This shortcut cannot be used in the STEREO OUTPUT block.

If the selected MATRIX channel is paired, this shortcut will operate differently depending on whether you press and hold the [SEL] switch of the odd-numbered (left) channel or of the even-numbered (right) channel.

- **If you press and hold the odd-numbered (left) [SEL] switch**, you can use the MIX OUTPUT block MIX [LEVEL/BAL] encoder to adjust the pan of the signal that is sent from that channel to the selected pair of MIX buses.

During this time, the MIX [NAME] indicator of the MIX OUTPUT block will alternately display “PAN” and the short name of the MIX channel, and the LEDs surrounding the MIX [LEVEL/BAL] encoder will indicate the pan value.

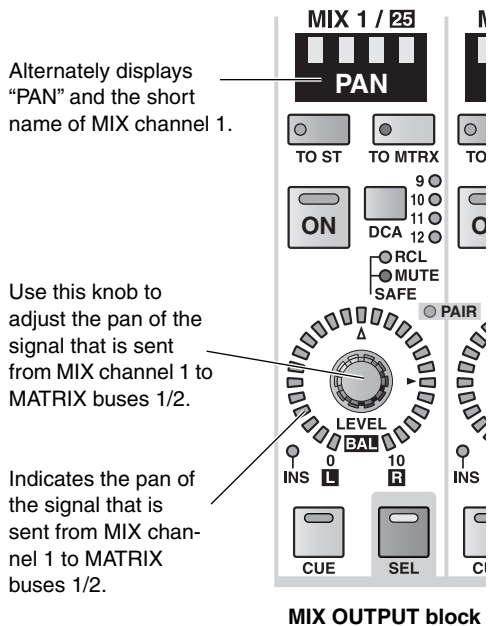
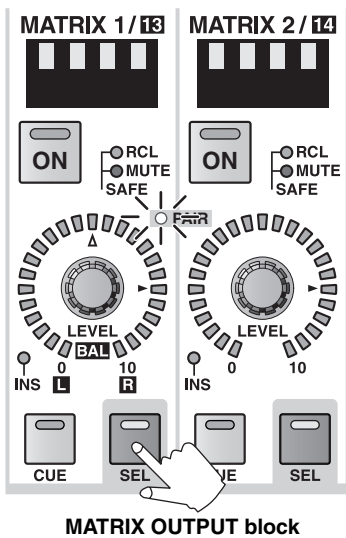

- **If you press and hold the even-numbered (right) [SEL] switch**, you can use the MIX OUTPUT block MIX [LEVEL/BAL] encoder to adjust the send level of the signal that is sent from that channel to the selected pair of MIX buses.

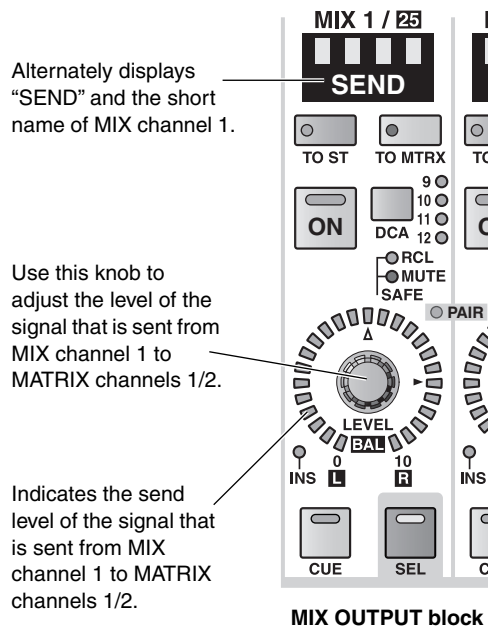
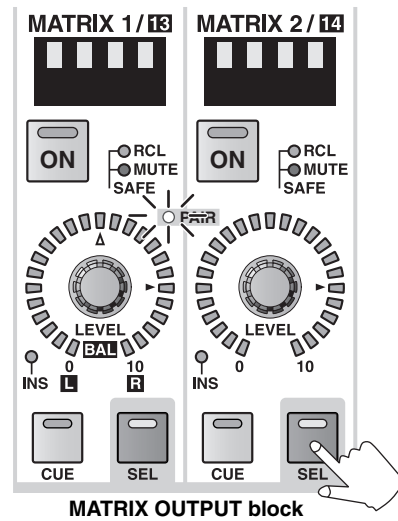

For either shortcut, it will take a certain amount of time from when you first press the [SEL] switch until the [NAME] indicator starts blinking. If you do not want to wait this long, you can hold down the [SEL] switch and immediately operate the [LEVEL/BAL] encoder of the send destination (or send source), and the shortcut will be enabled from that instant. If ROUTING is turned on in the AUTO DISPLAY ON/OFF area of the UTILITY function PREFERENCE screen, using this shortcut operation will immediately cause the display to shift to the MATRIX/ST ROUTING screen, and the cursor will move to the corresponding knob.

## DCA mute indicator

In previous versions, you could tell whether a DCA group was muted or unmuted by looking at the DCA block DCA [MUTE] switch LED (lit = muted, dark = unmuted). However, this does not tell you whether the channels belonging to that DCA group are muted in the INPUT block.

PM1D system software V1.5 provides a way for you to check whether individual channels are also muted when a DCA group is muted.

To do so, access the UTILITY function PREFERENCE screen, and turn DCA MUTE FLASH INDICATE on.

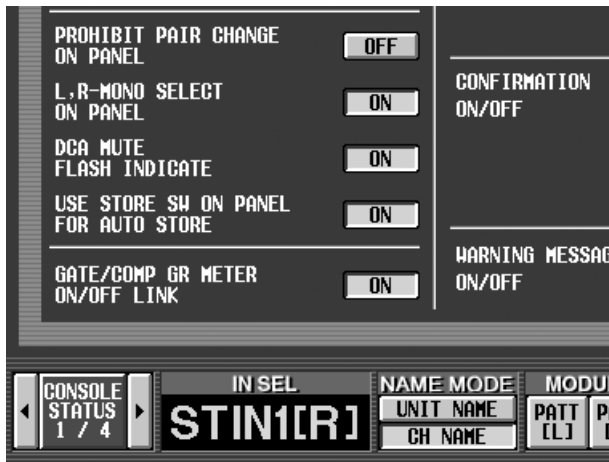

In this state, muting a DCA group will cause the DCA block DCA [MUTE] switch LED to blink, and will also cause the corresponding [ASSIGN DCA] LED of the channels belonging to that group to blink.

For example if you mute DCA group 12, [ASSIGN DCA] LED 2 will blink for input channels or output channels belonging to that group.

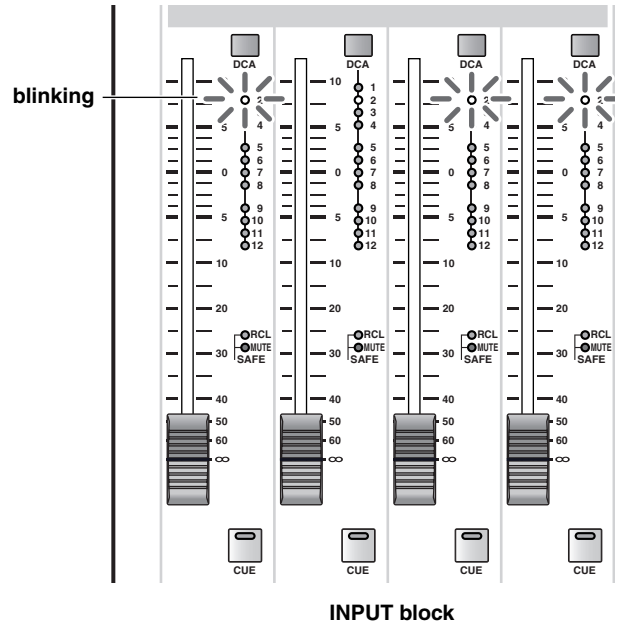

The [ASSIGN DCA] LED will also blink when you assign a channel to that DCA. However, it will blink more rapidly when muted.

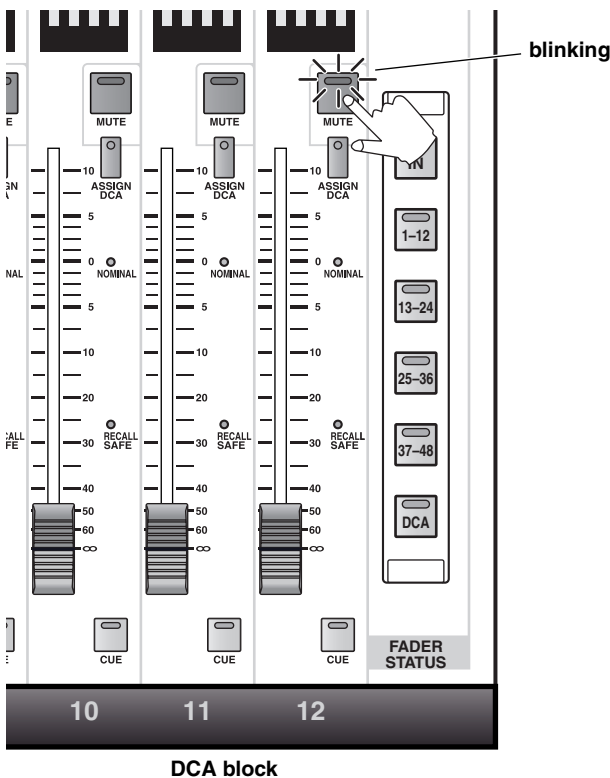

## Oscillator improvements

You can now use two different sine waves simultaneously in the OSCILLATOR screen. You can specify the frequency and level of each, and output them separately to odd-numbered / even-numbered channels.

### Improvements in the OSCILLATOR screen

In conjunction with the above improvements, the MON/CUE function OSCILLATOR screen has enhanced as follows.

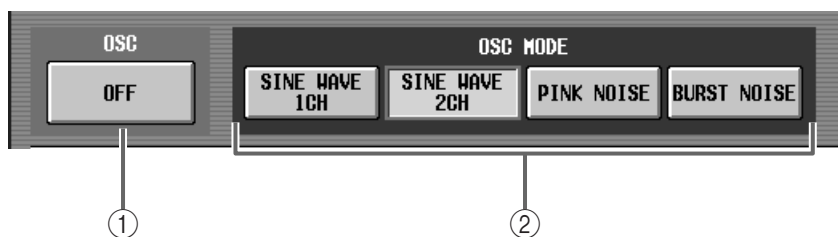

- ① **OSC ON/OFF (Oscillator on/off)**  
Switches the signal selected by OSC MODE (②) (sine wave or noise) on/off.
- ② **OSC MODE (Oscillator mode)**  
Selects one of the following to specify the type of output signal and the number of channels. The display in the PARAMETERS section will differ depending on your choice here.
  - **SINE WAVE 1CH**.....One sine wave will be used.
  - **SINE WAVE 2CH**.....Two sine waves will be used.
  - **PINK NOISE** .....Pink noise will be used.
  - **BURST NOISE** .....Burst noise will be used.



- If you select SINE WAVE 2CH, the L channel sine wave will be sent to the odd-numbered channel(s) (or the STEREO L channel) selected by the ASSIGN (4) parameter described below, and the R channel sine wave will be sent to the even-numbered channel(s) (or the STEREO R channel).
- If you select any other, the same signal will be output to all channels selected by the ASSIGN (4) parameter.

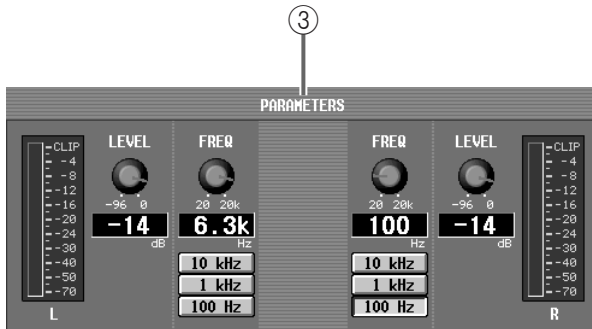

③ PARAMETERS

Here you can set the parameters of the sine wave or noise. The display in this section will differ depending on the choice of OSC MODE (2).

■ If you select SINE WAVE 1CH

A fixed-level sine wave will be sent to the specified bus(es).

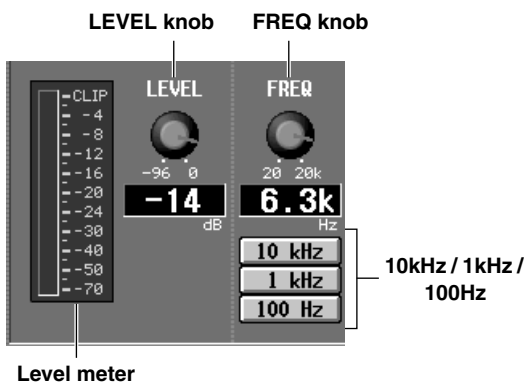

- **Level meter** ..... Indicates the output level of the sine wave.
- **LEVEL knob** ..... Adjusts the output level of the sine wave in a range of -96 dB to 0 dB. The current value is shown in the numerical box below the knob.
- **FREQ knob** ..... Adjusts the frequency of the sine wave in a range of 20 Hz–20 kHz. The current value is shown in the numerical box below the knob.
- **10 kHz / 1 kHz / 100 Hz** . These buttons set the frequency of the sine wave to preset values.

■ If you select SINE WAVE 2CH

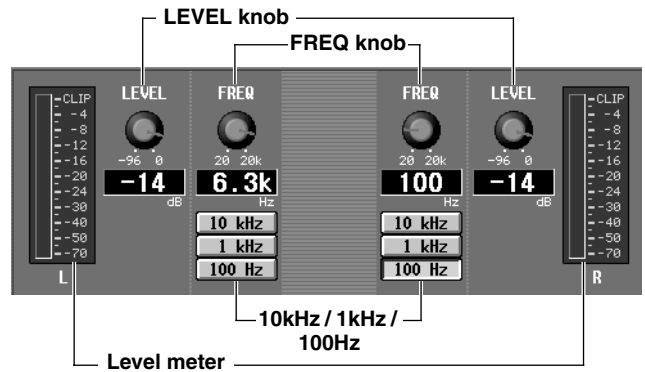

The level and frequency of the sine waves can be set independently for the L channel and R channel. The content of the parameters are the same as for SINE WAVE 1CH.

- ⚠ The two sine waves are generated completely independently. Even if you set both sine waves to the same frequency, they will not be in phase. If you want the phase to match, use SINE WAVE 1CH.

■ If you select PINK NOISE

Fixed-level pink noise will be sent to the specified bus(es).

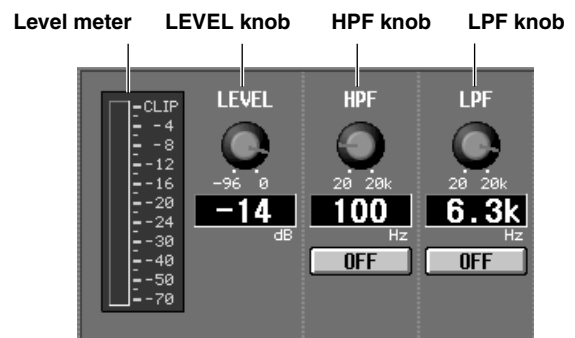

- **Level meter** ..... Indicates the output level of the noise.
- **LEVEL knob** ..... Adjusts the output level of the noise in a range of -96 dB to 0 dB. The current value is shown in the numerical box below the knob.
- **HPF knob / LPF knob** .. These knobs continuously adjust the frequency of the high pass filter and low pass filter that process the noise, in a range of 20 Hz–20 kHz. The current frequency is shown in the numerical box below each knob. You can also use the ON/OFF buttons located below each numerical box to switch the high pass filter and low pass filter on/off.

■ If you select BURST NOISE

Intermittent pink noise will be sent to the specified bus(es).

- **WIDTH knob**..... Adjusts the duration from when the pink noise is output until it stops, in a range of 0.1–10 seconds. The current value is shown in the numerical box below the knob.
- **INTERVAL**..... Adjusts the duration of the silence, in a range of 1–30 seconds. The current value is shown in the numerical box below the knob.

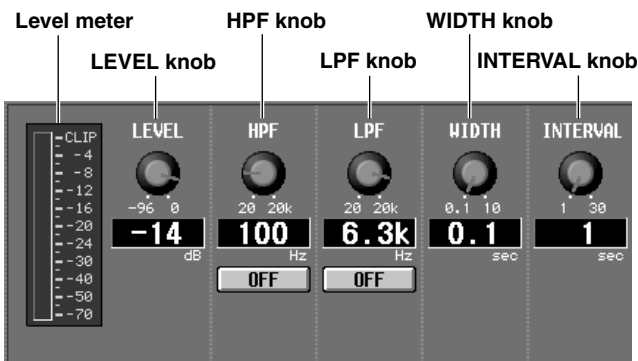

The remaining parameters are the same as for PINK NOISE.

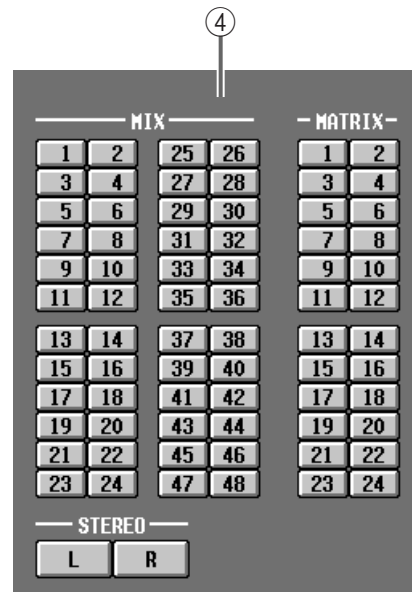

- ④ **ASSIGN**  
Selects the bus(es) to which the sine wave or noise will be output. (You may select more than one bus.)



- ⑤ **OSC OUT (Oscillator output)**  
Directly outputs the sine wave / pink noise to a physical port. Click the button to select the output destination port, and use the ON/OFF button to switch the output on/off.

⚠ If you select SINE WAVE 2CH for OSC MODE, the direct output will be sent from the L channel to OSC OUT.



## Improvements in the INPUT PATCH / OUTPUT PATCH screens

You can now display and edit the unit name for each port in the INPUT PATCH / OUTPUT PATCH screens. Also, vertical and horizontal red lines now indicate the currently selected grid.

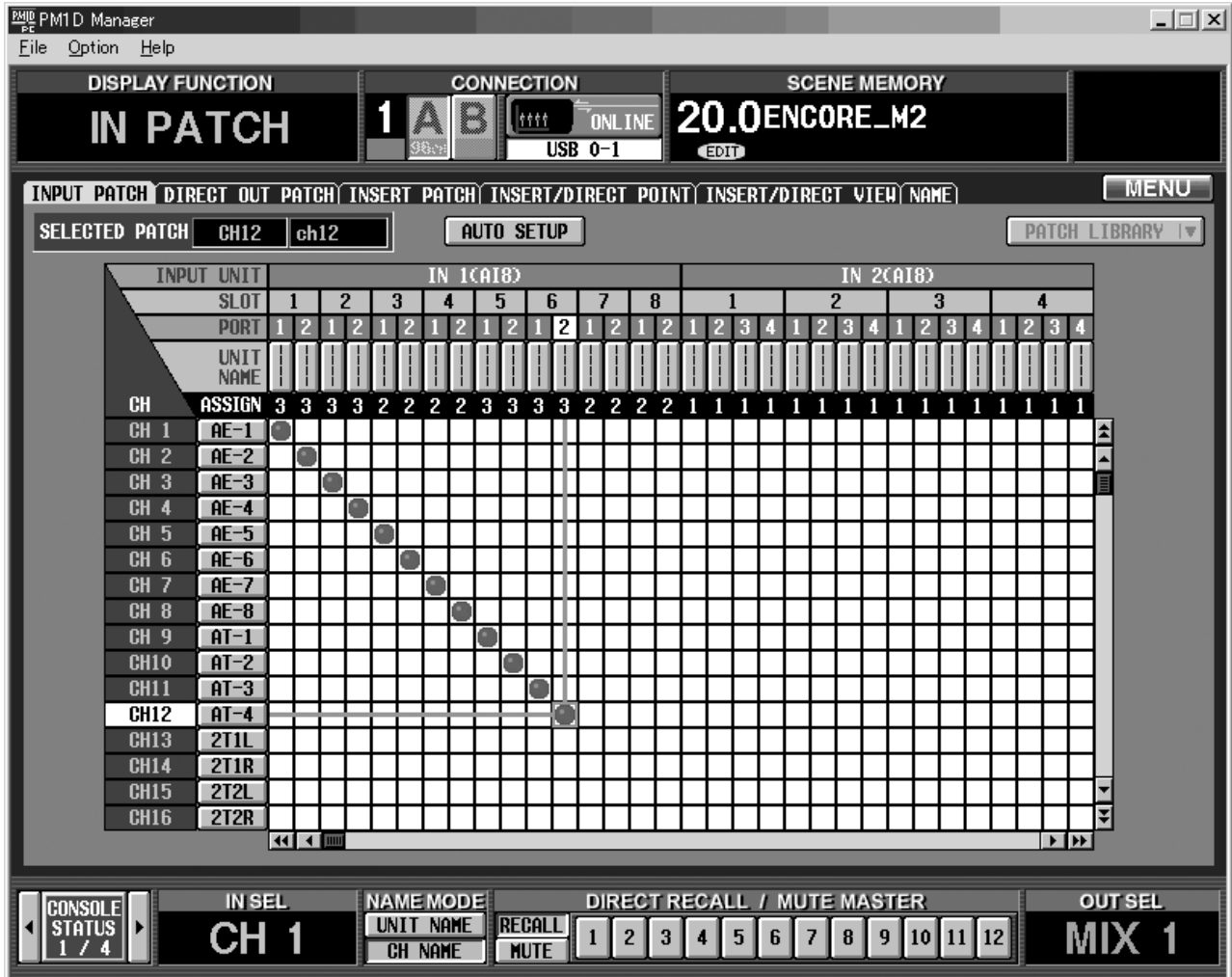

## USB PC (computer) connection

A PC running PM1D Manager can now be connected via USB. To use the USB connection, open PM1D Manager's Option popup window, and in the Communication Port select "YAMAHA USB OUTxxx (where xxx is the device number / port number)."

- ⚠ • Updating of the system software is performed using the serial port as before. Please note that updating cannot be performed via USB.
- If PM1D Manager is running on a USB-connected PC, and you want to connect/disconnect the USB cable or restart the connected console/engine, you must exit PM1D Manager and then restart your PC.  
In some cases, you may be unable to reconnect to the console/engine until the PC has restarted.
- ⚠ • Use a USB cable that is 3 meters or shorter. Do not use a USB hub or any other USB device together with this system. Communication may be unstable if you do so.
- USB connection is not guaranteed to be faster than a serial connection. Depending on your system, a serial connection may provide faster transmission speed and also be more stable. If you were able to establish a serial connection on the previous version, we recommend that you continue to use the serial connection.

## Automatic scrolling in the CH to MIX screen and MATRIX/ST ROUTING screen

In the PAN/ROUTING function CH to MIX screen and in the MATRIX/ST function MATRIX/ST ROUTING screen, the screen will now scroll in response to cursor movement.

For example as shown in the following illustrations, when the cursor in the CH to MIX screen is located at the lowest send point (PRE/POST button) for each MIX, pressing the CURSOR [▼] switch will cause the screen to scroll downward.

Also, you can hold down the [SHIFT/GRAB] switch and press the CURSOR [▼] switch to move immediately to the PRE POINT section (the PRE EQ/PRE FADER line) without scrolling.

In this way, scrollable areas in the CH to MIX screen and MATRIX/ST ROUTING screen will scroll when you press the CURSOR [▲]/[▼]/[◀]/[▶] switches in a direction that would move outside the border. Similarly, you can hold down the [SHIFT/GRAB] switch and press the CURSOR [▲]/[▼]/[◀]/[▶] switches to directly move the cursor outside the border without scrolling.

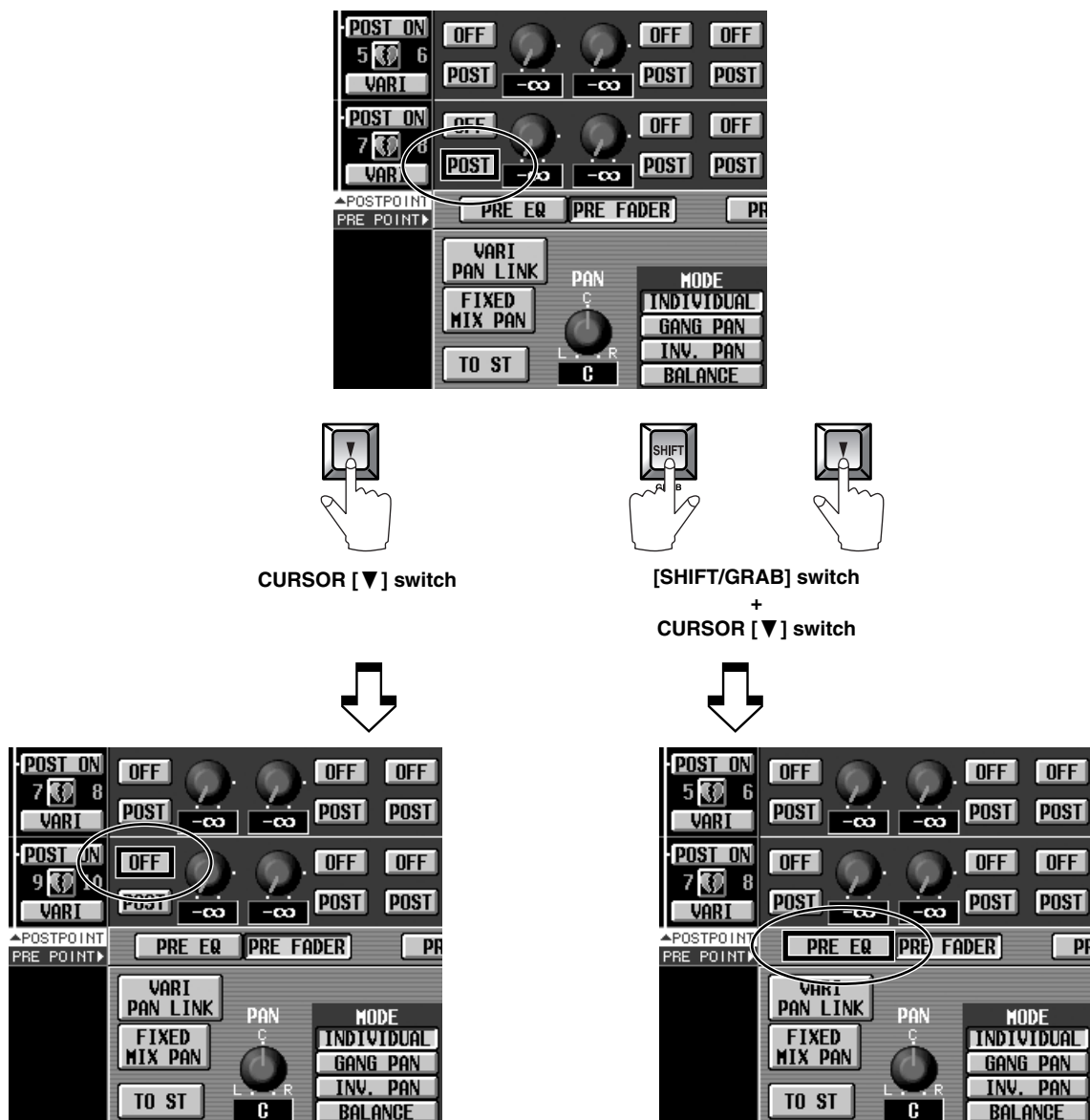

## ON/OFF button for COMM IN

In the MONITOR A screen, a button has been added to turn the COMM IN function on/off. When this button is off, the COMM IN function will be off, and the COMM IN signal will not be input. This operation is different than setting LEVEL to  $-\infty$ .

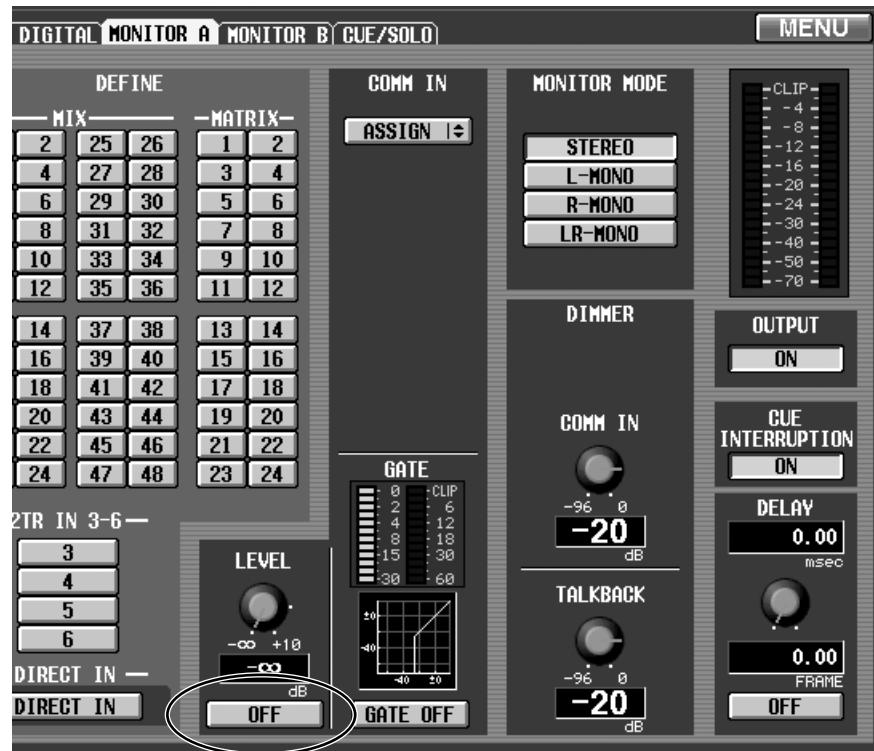

## Added functions in the PREFERENCE screen

The following functions have been added to the UTILITY function PREFERENCE screen.



### ■ DCA MUTE FLASH INDICATE ON/OFF button

If this button is on and a DCA group is muted, the mute switch of that DCA and the DCA ASSIGN LED of channels belonging to that group will blink.

### ■ USE STORE SW ON PANEL FOR AUTO STORE ON/OFF button

If this button is on, you can use the Auto Store function (→p.64) from the panel [STORE] switch.

### ■ STEAL PATCH ON/OFF button

If this button is on, and you attempt to patch in the PATCH screen, a warning will be issued that this unit is already patched.

### ■ SELECTED CH ON/OFF button

If the SELECTED CH ON/OFF button in this section is turned on, pressing the [SEL] switch of an input channel or output channel will cause the cursor to move to the corresponding location in the screen that contains the parameters of that channel (or, switch to the screen that contains the corresponding channel). In previous ver-

sions, if a AUTO DISPLAY ON/OFF setting was turned on, the cursor would move only if the [SEL] switch were operated in a screen that contained that function.

However since SELECTED CH ON/OFF can now be specified independently, you can enable cursor movement in response to the [SEL] switch in any screen, even if all other AUTO DISPLAY ON/OFF items are turned off.



---

## Supplementary explanation for existing functions

---

### ■ MIRROR setting when set to CONSOLE CLOCK MASTER

When using the system in Mirror mode, you can use the console as the word clock master rather than a clock generator, and distribute the word clock from the console's WORD CLOCK OUT connector to the WORD CLOCK IN connectors of each unit. This will prevent each unit from being muted when you switch between engine A and B.

## Scene Memory/Effect Library to Program Change Table

Please refer to page 35 in the appendix of the CS1D Reference Manual (Appendices).

### MIDI control change NRPN (Non Registered Parameter Number) assignment table

INPUT (NRPN LSB 0-111 : CH NUMBER1-96,STIN1L-8R)

Parameter name	NRPN	
	MSB	LSB
ON/OFF	0	0-111
FADER	1	0-111
PAN/BALANCE	2	0-111
RECALL SAFE ON/OFF	3	0-111
GATE ON/OFF	4	0-111
GATE RANGE	5	0-111
GATE LPF ON/OFF	6	0-111
GATE LPF FREQ	7	0-111
GATE HPF ON/OFF	8	0-111
GATE HPF FREQ	9	0-111
GATE THRESHOLD	10	0-111
GATE ATTACK	11	0-111
GATE DECAY	12	0-111
GATE HOLD	13	0-111
COMP ON/OFF	14	0-111
COMP RATIO	15	0-111
COMP XOVER ON/OFF	16	0-111
COMP XOVER FREQ	17	0-111
COMP KNEE/WIDTH	18	0-111
COMP OUT GAIN	19	0-111
COMP THRESHOLD	20	0-111
COMP ATTACK	21	0-111
COMP RELEASE	22	0-111
EQ LOW TYPE	23	0-111
EQ HIGH TYPE, LPF SLOPE	24	0-111
EQ ON/OFF	25	0-111
HPF ON/OFF	26	0-111
EQ ATT	27	0-111
EQ LOW F	28	0-111
EQ LOW G	29	0-111
EQ LOW Q	30	0-111
EQ L-MID F	31	0-111
EQ L-MID G	32	0-111
EQ L-MID Q	33	0-111
EQ H-MID F	34	0-111
EQ H-MID G	35	0-111
EQ H-MID Q	36	0-111
EQ HIGH F	37	0-111
EQ HIGH G	38	0-111
EQ HIGH Q	39	0-111
HPF FREQ	40	0-111

MIX (NRPN LSB 0-47,48-95 : MIX1-48)

Parameter name	NRPN	
	MSB	LSB
ON/OFF	68	0-47
FADER	68	48-95
BALANCE	69	0-47
RECALL SAFE ON/OFF	69	48-95
COMP ON/OFF	70	0-47
COMP RATIO	70	48-95
COMP XOVER ON/OFF	71	0-47
COMP XOVER FREQ	71	48-95
COMP KNEE/WIDTH	72	0-47
COMP OUT GAIN	72	48-95
COMP THRESHOLD	73	0-47
COMP ATTACK	73	48-95
COMP RELEASE	74	0-47
EQ ON/OFF	74	48-95
EQ SUB-LOW TYPE,SLOPE	75	0-47
EQ HIGH TYPE,SLOPE	75	48-95
EQ SUB-LOW Q	76	0-47
EQ SUB-LOW F	76	48-95
EQ SUB-LOW G	77	0-47
EQ SUB-LOW BYPASS	77	48-95
EQ LOW Q	78	0-47
EQ LOW F	78	48-95
EQ LOW G	79	0-47
EQ LOW BYPASS	79	48-95
EQ L-MID Q	80	0-47
EQ L-MID F	80	48-95
EQ L-MID G	81	0-47
EQ L-MID BYPASS	81	48-95
EQ MID Q	82	0-47
EQ MID F	82	48-95
EQ MID G	83	0-47
EQ MID BYPASS	83	48-95
EQ H-MID Q	84	0-47
EQ HI-MID F	84	48-95
EQ H-MID G	85	0-47
EQ H-MID BYPASS	85	48-95
EQ HIGH Q	86	0-47
EQ HIGH F	86	48-95
EQ HIGH G	87	0-47
EQ HIGH BYPASS	87	48-95

**MATRIX (NRPN LSB 0-23,24-47,48-71,72-95 : MATRIX1-24)**

Parameter name	NRPN	
	MSB	LSB
ON/OFF	90	0-23
FADER	90	24-47
BALANCE	90	48-71
RECALL SAFE ON/OFF	90	72-96
COMP ON/OFF	91	0-23
COMP RATIO	91	24-47
COMP XOVER ON/OFF	91	48-71
COMP XOVER FREQ	91	72-96
COMP KNEE/WIDTH	92	0-23
COMP OUT GAIN	92	24-47
COMP THRESHOLD	92	48-71
COMP ATTACK	92	72-96
COMP RELEASE	93	0-23
EQ ON/OFF	93	24-47
EQ SUB-LOW TYPE,SLOPE	93	48-71
EQ HIGH TYPE,SLOPE	93	72-96
EQ SUB-LOW Q	94	0-23
EQ SUB-LOW F	94	24-47
EQ SUB-LOW G	94	48-71
EQ SUB-LOW BYPASS	94	72-96
EQ LOW Q	95	0-23
EQ LOW F	95	24-47
EQ LOW G	95	48-71
EQ LOW BYPASS	95	72-96
EQ L-MID Q	96	0-23
EQ L-MID F	96	24-47
EQ L-MID G	96	48-71
EQ L-MID BYPASS	96	72-96
EQ MID Q	97	0-23
EQ MID F	97	24-47
EQ MID G	97	48-71
EQ MID BYPASS	97	72-96
EQ H-MID Q	98	0-23
EQ H-MID F	98	24-47
EQ H-MID G	98	48-71
EQ H-MID BYPASS	98	72-96
EQ HIGH Q	99	0-23
EQ HIGH F	99	24-47
EQ HIGH G	99	48-71
EQ HIGH BYPASS	99	72-96

**ST MASTER (NRPN LSB EVEN,ODD : STEREO MASTER A,B)**

Parameter name	NRPN	
	MSB	LSB
ON/OFF	101	0,1
FADER	101	2,3
BALANCE	101	4,5
RECALL SAFE ON/OFF	101	6,7
COMP ON/OFF	101	8,9
COMP RATIO	101	10,11
COMP XOVER ON/OFF	101	12,13
COMP XOVER FREQ	101	14,15
COMP KNEE/WIDTH	101	16,17
COMP OUT GAIN	101	18,19
COMP THRESHOLD	101	20,21
COMP ATTACK	101	22,23
COMP RELEASE	101	24,25
EQ ON/OFF	101	26,27
EQ SUB-LOW TYPE, SLOPE	101	28,29
EQ HIGH TYPE, SLOPE	101	30,31
EQ SUB-LOW Q	101	32,33
EQ SUB-LOW F	101	34,35
EQ SUB-LOW G	101	36,37
EQ SUB-LOW BYPASS	101	38,39
EQ LOW Q	101	40,41
EQ LOW F	101	42,43
EQ LOW G	101	44,45
EQ LOW BYPASS	101	46,47
EQ L-MID Q	101	48,49
EQ L-MID F	101	50,51
EQ L-MID G	101	52,53
EQ L-MID BYPASS	101	54,55
EQ MID Q	101	56,57
EQ MID F	101	58,59
EQ MID G	101	60,61
EQ MID BYPASS	101	62,63
EQ H-MID Q	101	64,65
EQ HI-MID F	101	66,67
EQ H-MID G	101	68,69
EQ HI-MID BYPASS	101	70,71
EQ HIGH Q	101	72,73
EQ HIGH F	101	74,75
EQ HIGH G	101	76,77
EQ HIGH BYPASS	101	78,79

**DCA (NRPN LSB 0-11,12-23 : DCA1-12)**

Parameter name	NRPN	
	MSB	LSB
DCA FADER(0-11)	102	0-11
DCA MUTE(12-23)	102	12-23

**EFFECT (NRPN LSB 0-7,8-15,16-23,24-31,32-39,40-47,48-55,56-63,64-71,72-79,80-87,88-95,96-103,104-111 : EFFECT1-8)**

Parameter name	NRPN	
	MSB	LSB
BYPASS ON/OFF	103	0-7
ATT L	103	8-15
ATT R	103	16-23
WET BALANCE	103	24-31
PARAMETER1	103	32-39
PARAMETER2	103	40-47
PARAMETER3	103	48-55
PARAMETER4	103	56-63
PARAMETER5	103	64-71
PARAMETER6	103	72-79
PARAMETER7	103	80-87
PARAMETER8	103	88-95
PARAMETER9	103	96-103
PARAMETER10	103	104-111
PARAMETER11	104	0-7
PARAMETER12	104	8-15
PARAMETER13	104	16-23
PARAMETER14	104	24-31
PARAMETER15	104	32-39
PARAMETER16	104	40-47
PARAMETER17	104	48-55
PARAMETER18	104	56-63
PARAMETER19	104	64-71
PARAMETER20	104	72-79
PARAMETER21	104	80-87

**GEQ (NRPN LSB 0-23,24-47,48-71,72-95,96-119 : GEQ1-24)**

Parameter name	NRPN	
	MSB	LSB
GEQ ON/OFF	105	0-23
NOTCH1 ON/OFF	105	24-47
NOTCH2 ON/OFF	105	48-71
NOTCH3 ON/OFF	105	72-95
NOTCH4 ON/OFF	105	96-119
GEQ BAND1 G	106	0-23
GEQ BAND2 G	106	24-47
GEQ BAND3 G	106	48-71
GEQ BAND4 G	106	72-95
GEQ BAND5 G	106	96-119
GEQ BAND6 G	107	0-23
GEQ BAND7 G	107	24-47
GEQ BAND8 G	107	48-71
GEQ BAND9 G	107	72-95
GEQ BAND10 G	107	96-119
GEQ BAND11 G	108	0-23
GEQ BAND12 G	108	24-47
GEQ BAND13 G	108	48-71
GEQ BAND14 G	108	72-95
GEQ BAND15 G	108	96-119
GEQ BAND16 G	109	0-23
GEQ BAND17 G	109	24-47
GEQ BAND18 G	109	48-71
GEQ BAND19 G	109	72-95
GEQ BAND20 G	109	96-119
GEQ BAND21 G	110	0-23
GEQ BAND22 G	110	24-47
GEQ BAND23 G	110	48-71
GEQ BAND24 G	110	72-95
GEQ BAND25 G	110	96-119
GEQ BAND26 G	111	0-23
GEQ BAND27 G	111	24-47
GEQ BAND28 G	111	48-71
GEQ BAND29 G	111	72-95
GEQ BAND30 G	111	96-119
GEQ BAND31 G	112	0-23
NOTCH1 Q	112	24-47
NOTCH2 Q	112	48-71
NOTCH3 Q	112	72-95
NOTCH4 Q	112	96-119
NOTCH1 F	113	24-47
NOTCH2 F	113	48-71
NOTCH3 F	113	72-95
NOTCH4 F	113	96-119



## MIDI control change parameter assignment table

Use this table to make a note of the parameters that you have assigned to control numbers in the MIDI CTRL CHANGE screen. In the “PARAMETER FROM” columns, write the name and NRPN# (→p.94) of the parameter that you want to operate via the corresponding control number. In the “PARAMETER TO (MULTI MODE)” columns, write the NRPN# that is +15 greater than the above value, and its parameter name. You can use the corresponding control change to operate the “PARAMETER FROM” parameter in Single mode, or to operate the “PARAMETER FROM” through “PARAMETER TO” parameters in Multi mode. If you execute INITIALIZE, all control numbers will be set to “NO ASSIGN.”

CTRL CHG.#	PARAMETER FROM			PARAMETER TO(MULTI MODE)		
	NRPN#	Parameter name	CH	NRPN#	Parameter name	CH
1						
2						
3						
4						
5						
7						
8						
9						
10						
11						
12						
13						
14						
15						
16						
17						
18						
19						
20						
21						
22						
23						
24						
25						
26						
27						
28						
29						
30						
31						
33						
34						
35						
36						
37						
39						
40						
41						
42						
43						
44						

CTRL CHG.#	PARAMETER FROM			PARAMETER TO(MULTI MODE)		
	NRPN#	Parameter name	CH	NRPN#	Parameter name	CH
45						
46						
47						
48						
49						
50						
51						
52						
53						
54						
55						
56						
57						
58						
59						
60						
61						
62						
63						
64						
65						
66						
67						
68						
69						
70						
71						
72						
73						
74						
75						
76						
77						
78						
79						
80						
81						
82						
83						
84						
85						
86						
87						
88						
89						
90						
91						
92						
93						
94						
95						

CTRL CHG.#	PARAMETER FROM			PARAMETER TO(MULTI MODE)		
	NRPN#	Parameter name	CH	NRPN#	Parameter name	CH
102						
103						
104						
105						
106						
107						
108						
109						
110						
111						
112						
113						
114						
115						
116						
117						
118						
119						

# MIDI Data Format

## 1. TRANSMIT/RECEIVE DATA

### 1.1 CHANNEL MESSAGE

#### 1.1.1 CONTROL CHANGE (Bn) BANK SELECT

**<Reception>**

In PROGRAM CHANGE SINGLE CH mode when [Bank] is ON, this message can be received via the MIDI IN for BANK SELECT reception is enabled, if the [Rx CH] matches.

This will specify the bank for a subsequently-received program change.

**<Transmission>**

In SINGLE CH mode when [Bank] is ON, and you recall a scene memory or effect library, a bank select message will be transmitted (before the program change message) from the selected MIDI OUT, on the specified [Tx CH].

STATUS	1011nnnn	Bn	Control Change
	00000000	00	Bank Select MSB
	0vvvvvvv	vv	MSB Value
	00100000	20	Bank Select LSB
	0vvvvvvv	vv	LSB Value

#### 1.1.2 CONTROL CHANGE (Bn) ASSIGN

**<Reception>**

If CONTROL CHANGE ASSIGN is ON and CONTROL CHANGE is set to SINGLE CH mode, this message can be received from the MIDI IN for which reception is enabled, if the [Rx CH] matches. The parameter that is assigned in the [Control Change Table] will be modified.

In MULTI mode, any MIDI channel will be received. The received MIDI channel (i.e., its number) will be added to the number of the parameter assigned in the [Control Change Table] (the same number as NRPN) to determine the parameter that will be modified by the message.

This message is not echoed, but will be transmitted as described below even when a parameter is modified as a result of the MIDI reception.

**<Transmission>**

In SINGLE CH mode, when a parameter assigned in the [Control Change Table] has been modified, this message will be transmitted from the MIDI OUT for the selected [Tx CH].

In MULTI CH mode, when a parameter corresponding to a parameter number (same as NRPN) assigned in the [Control Change Table] +15 or less is modified, this message will be transmitted from the selected MIDI OUT, with the MIDI channel representing the difference from the parameter number. If the parameter is assigned to more than one control number, the message will be transmitted using the lowest-numbered control number.

If a parameter with a resolution of greater than 7 bits is assigned to a control number in the range of 1-31, that control number +32 can be assigned as the LSB of the same parameter.

STATUS	1011nnnn	Bn	Control Change
	0ccccccc	cc	Control No. (1-5, 7-31, 33-37, 39-95, 102-119)
	0vvvvvvv	vv	Value

The transmitted and received values are calculated as follows. (The same applies to the NRPN messages discussed later.)

Given the following:

$(128 \text{ or } 16384 \text{ in the case of word data}) / (\text{number of parameter steps})$

$= X \dots Y$

$\text{INT}((Y + 1) / 2) = Z$

Reception:

If  $(\text{MIDI data} - Z) < 0$ , then parameter = 0

If  $((\text{MIDI data} - Z) / Z) > \text{MAX}$ , then parameter = MAX

Otherwise,  $\text{INT}(\text{MIDI data} - Z) / X = \text{parameter}$

Transmission:

If parameter = 0, then MIDI data = 0

If parameter = MAX, then MIDI data = (127 or 16383 in the case of word data)

Otherwise,  $(X \times \text{parameter}) + \text{INT}(X / 2) + Z = \text{MIDI data}$

#### 1.1.3 CONTROL CHANGE (Bn) NRPN

**<Reception>**

If NRPN is ON, and if the [Rx CH] matches, this message can be received at the MIDI IN for which reception is enabled.

There is a one-to-one correspondence between the received NRPN number and the parameter that will change. (See the "MIDI control change NRPN (Non Registered Parameter Number) assignment table".)

This message is not echoed, but the transmission described below will occur even if a parameter is modified due to MIDI reception.

**<Transmission>**

If NRPN is ON and a parameter is modified, this message will be transmitted from the MIDI OUT selected by [Tx CH].

If both CONTROL ASSIGN and NRPN are simultaneously ON, an assigned parameter will be transmitted as a control change.

If the parameter has a resolution of less than 7 bits, only the MSB data will be transmitted.

STATUS	1011nnnn	Bn	Control Change
	01100010	62	NRPN LSB
	0vvvvvvv	vv	MSB Value
	01100011	63	NRPN MSB
	0vvvvvvv	vv	LSB Value
	00000110	06	DATA ENTRY MSB
	0vvvvvvv	vv	MSB Value
	00110110	26	DATA ENTRY LSB
	0vvvvvvv	vv	LSB Value

60 h (INC) and 61 h (DEC) are not supported.

#### 1.1.4 PROGRAM CHANGE (Cn)

**<Reception>**

If [Program Change Rx] is ON, this message can be received at the MIDI IN for which reception is enabled, if the [Rx CH] matches in the case of SINGLE mode. However if [OMNI] is ON, this message will be received regardless of the channel.

In the case of MULTI mode, all MIDI channels will be received, and will be divided into banks according to the channel.

If [Program Change ECHO] is ON, this message will be echoed.

A scene memory or effect library will be recalled according to the settings of the [Program Change Table].

**<Transmission>**

If [Program Change TX] is ON, this message will be transmitted from the selected MIDI OUT on the [Tx CH] channel (in the case of SINGLE mode), when a scene or effect library is recalled.

In the case of MULTI mode, this will be transmitted on the MIDI channel according to the bank. If the recalled memory number is assigned to more than one program number, the program number for the lowest-numbered channel of the lowest-numbered bank will be transmitted.

STATUS	1100nnnn	Cn	Program Change
DATA	0nnnnnnn	nn	Program No. (0-127)

### 1.2 EXCLUSIVE MESSAGE (F0-F7)

#### 1.2.1 MOTION CONTROL STATE (MCS) MMC STOP/PLAY/FORWARD/REWIND

**<Transmission>**

These messages are transmitted by assignment to USER DEFINE or GPI.

[DEVICE NO.] specifies the transmission destination.

STATUS	11110000	F0	System Exclusive Message
ID No.	01111111	7F	Real Time System Exclusive
Device ID	0ddddddd	dd	Destination (00-7E, 7F:all call)
Command	00000110	06	Machine Control Command(mcc) sub-id
	0ccccccc	cc	Command String
			[1]:Stop
			[3]:Deferred Play
			[4]:Fast Forward
			[5]:Rewind
EOX	11110111	F7	End of Exclusive

#### 1.2.2 MOTION CONTROL PROCESS (MCP) MMC LOCATE (target)

**<Transmission>**

This message is transmitted by assignment to USER DEFINE or GPI. [DEVICE NO.] specifies the transmission destination. (This requires setting the ID of the receiving device.)

STATUS	11110000	F0	System Exclusive Message
ID No.	01111111	7F	Real Time System Exclusive
Device ID	0ddddddd	dd	Destination (00-7E, 7F:all call)
Command	00000110	06	Machine Control Command(mcc) sub-id
	01000100	44	Locate
	00000110	06	byte count
	00000001	01	"target" sub command
	0tthhhhh	th	frame type, hour
	0mmmmmmm	mm	minute
	0sssssss	ss	second
	0ffffff	ff	frame
	0sssssss	ss	sub-frame (only '0')
EOX	11110111	F7	End of Exclusive

### 1.3 ACTIVE SENSING (Fe)

**<Reception>**

Once this message has been received, and there is an interval of 300 ms during which nothing is received, Running Status will be cleared, and MIDI communication will be initialized.

STATUS	11111110	FE	Active Sensing
--------	----------	----	----------------

## 2. TRANSMISSION CONDITION

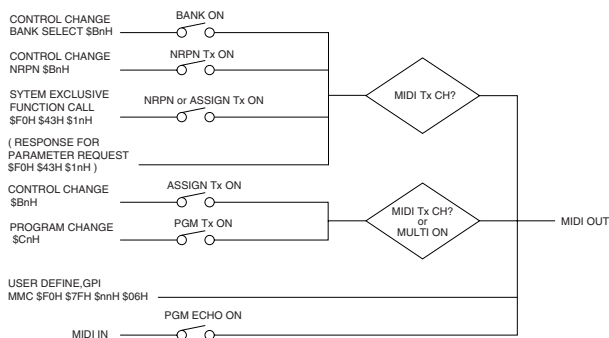

## 3. RECEIVE CONDITION

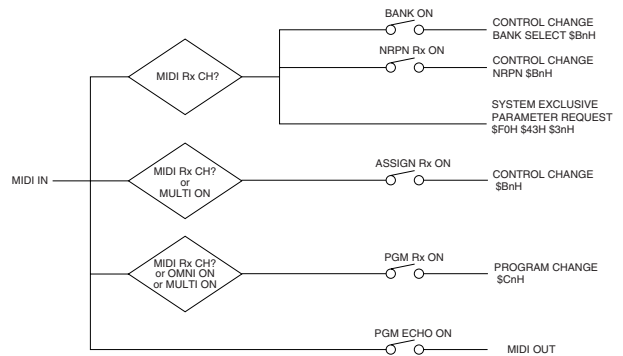

## 4. PARAMETER CHANGE

**BASIC FORMAT**

STATUS	11110000	F0	System Exclusive Message
ID No.	01000011	43	Manufacture's ID No. (YAMAHA)
SUB STATUS	0pppnenn	pn	p=mode 1:parameter change or response for request 3:parameter request n=0-15(Device Channel No.1-16)
GROUP ID	00111110	3e	MODEL ID(digital mixer)
MODEL ID	00001001	09	Device code (PM1D)
PARAM TYPE	0ttttttt	tt	(TYPE)
DATA	0ddddddd	dd0	DATA 0
	:	:	:
	0ddddddd	ddn	DATA n
EOX	11110111	F7	End of Exclusive

### PARAMETER VALUE REQUEST (type 0x00:Current Memory)

**<Reception>**

These messages can be received via the port that is enabled for reception. The VALUE RESPONSE message described below is sent in reply to this message.

STATUS	11110000	F0	System Exclusive Message
ID No.	01000011	43	Manufacture's ID No. (YAMAHA)
SUB STATUS	0pppnenn	3n	parameter request n=0-15(Device Channel No.1-16)
GROUP ID	00111110	3e	MODEL ID(digital mixer)
MODEL ID	00001001	09	Device code (PM1D)
PARAM TYPE	00000000	00	Current Memory
DATA	0ttttttt	dd0	data type
	0aaaaaaa	dd1	addressHIGH (BIT13-7)
	0aaaaaaa	dd2	addressLOW (BIT6-0)
	0ddddddd	dd3	REQUEST BYTE COUNT
EOX	11110111	F7	End of Exclusive

data type	0x00	SCENE LOW ADDRESS(BIT14 LOW)
	0x10	SCENE HIGH ADDRESS(BIT14 HIGH)
	0x0a	ENGINE SETUP

### PARAMETER VALUE RESPONSE (type 0x00:Current Memory)

**<Transmission>**

This message is sent in reply when the above VALUE REQUEST is received.

STATUS	11110000	F0	System Exclusive Message
ID No.	01000011	43	Manufacture's ID No. (YAMAHA)
SUB STATUS	0pppnenn	1n	response for request

```

n=0-15(Device Channel
No.1-16)
GROUP ID 00111110 3e MODEL ID(digital mixer)
MODEL ID 00001001 09 Device code(PM1D)
PARAM TYPE 00000000 00 Current Memory
DATA 0ttttttt dd0 data type
0aaaaaaa dd1 addressHIGH(BIT13-7)
0aaaaaaa dd2 addressLOW(BIT6-0)
0ddddd dd3 data
:
0ddddd ddn
EOX 11110111 F7 End of Exclusive

```

- 1:RECALL SAFE INPUT ALL ON,
- 2:RECALL SAFE INPUT ALL OFF,
- 3:RECALL SAFE OUTPUT ALL ON,
- 4:RECALL SAFE OUTPUT ALL OFF

EFF LIBRARY is transmitted when you recall a number that is not assigned to a program change.

Data type:

The "data" field contains the requested number of data bytes from the requested address, converted from 8-bit to 7-bit form. The MSB's for seven bytes will be the first byte of data.

Example) [seven bytes of 8 bit data] [8 bytes of 7 bit data]  
 80 01 82 03 84 05 06 → 54 00 01 02 03 04 05 06

The "data type" is the same as for a Parameter Value Request.

**PARAMETER CHANGE (type 0x02:function call)**

<Transmission>

If transmission is ON for Control Change ASSIGN or NRPN, this message is transmitted when an operation causing multiple parameters to be modified simultaneously is performed. This message is not received.

```

STATUS 11110000 F0 System Exclusive Message
ID No. 01000011 43 Manufacture's ID
No. (YAMAHA)
SUB STATUS 0ppppnnn 1n response for request
n=0-15(Device Channel
No.1-16)
GROUP ID 00111110 3e MODEL ID(digital mixer)
MODEL ID 00001001 09 Device code(PM1D)
PARAM TYPE 00000010 02 function call
DATA 0ttttttt dd0 function
0aaaaaaa dd1 category/number
0aaaaaaa dd2 channel/number2
0ddddd dd3 type
EOX 11110111 F7 End of Exclusive

```

function	category/number	number2,channel
0x04 EFF Lib Recall	LIB No.Bit7-1	LIB No..Bit0, EFF No.0-7
	(LIB No.1-199, EFF No.0-7)	
0x04 EFF Copy	No.Bit7-1	No.Bit0, EFF No.0-7
	(No.255, EFF No.0-7)	
0x05 GEQ Recall	Category Library 126	GEQ No.0-23
0x05 GEQ Copy,Link	No.127	GEQ No.0-23
0x06 IN EQ Lib Recall	Category Library 126	CH No.0-111
0x06 IN EQ Copy	Category Copy 127	CH No.0-111
0x07 OUT EQ Lib Recall	Category Library 126	CH No.0-73
0x07 OUT EQ Copy	Category Copy 127	CH No.0-73
0x08 IN GATE Lib Recall	Category Library 126	CH No.0-111
0x08 IN GATE Copy	Category Copy 127	CH No.0-111
0x09 IN COMP Lib Recall	Category Library 126	CH No.0-111
0x09 IN COMP Change	Category Copy 127	CH No.0-111
0x0a OUT COMP Lib Recall	Category Library 126	CH No.0-73
0x0a OUT COMP Change	Category Copy 127	CH No.0-73
0x0b IN CH Lib Recall	Category Library 126	CH No.0-111
0x0c OUT CH Lib Recall	Category Library 126	CH No.0-73
0x0d IN CH COPY	Source CH No.0-111	Destination CH No.0-111
0x0e OUT CH COPY	Source CH No.0-73	Destination CH No.0-73
0x0f IN CH PAIR/LR-MONO *1		CH No.0-111
0x10 OUT CH PAIR *1		CH No.0-73
0x11 SETUP CHANGE 127		0

(\*1 0:PAIR L->R, 1:PAIR R->L, 2:RESET BOTH, 3:PAIR RELEASE  
 4:L-MONO, 5:R-MONO, 6:LR-MONO, 7:L,R,LR-MONO RELEASE )

type

- For EFF BIT5-0:EFFECT TYPE
- For GEQ BIT6:MONO/LINK
- For EQ, GATE, COMP, CH, COPY, PAIR  
 BIT6:MONO/PAIR, BIT5-3:reserved  
 BIT2:GATE TYPE, BIT1, 0:COMP TYPE
- For SETUP 0:LOAD,

MIDI Implementation Chart

Function...	Transmitted	Recognized	Remarks
Basic Channel Default Changed	1-16 1-16	1-16 1-16	Memorized
Mode Default Messages Altered	X X *****	OMNI off/OMNI on X X	Memorized
Note Number True Voice	X *****	X X	
Velocity Note On Note Off	X X	X X	
After Touch Key's Ch's	X X	X X	
Pitch bend	X	X	
Control Change 0,32 1-5,7-31,33-37 39-95,102-119 98,99 6,38	O O O O	O O O O	Bank Select Assignable  NRPN (Non Registered Parameter Number) Data Entry (for NRPN)
Prog Change :True#	0-127 *****	0-127 0.0-99.9	Assignable
System Exclusive	O	O	*1
System Common :Song Pos :Song Sel :Tune	X X X	X X X	
System Real Time :Clock :Commands	X X	X X	
Aux Messages :Local ON/OFF :All Notes OFF :Active Sense :Reset	X X X X	X X O X	
Notes	*1: Parameter Change/Request and MMC.		

