



EXTERNAL  
IEEE 1394/USB2.0  
International

English

Deutsch

Français

Español

# CD-R/RW Drive **CRW-F1** DX

OWNER'S MANUAL  
BEDIENUNGSANLEITUNG  
MODE D'EMPLOI  
MANUAL DE INSTRUCCIONES



Advanced  
**AudioMASTER**  
QUALITY RECORDING

**DiscT@2**<sup>TM</sup>

**SafeBurn**<sup>TM</sup>



# FCC INFORMATION

## **COMPLIANCE INFORMATION STATEMENT**

(DECLARATION OF CONFORMITY PROCEDURE)

Responsible Party: Yamaha Electronics Corporation, USA.  
Address: 6660 Orangethorpe Avenue  
Buena Park, CA 90620  
Telephone: 714-522-9105  
Fax: 714-670-0108  
Type of Equipment: CD Recordable/Rewritable Drive  
Model Name: CRW-F1DX

This device complies with Part 15 of the FCC Rules.

Operation is subject to the following conditions:

- 1) this device may not cause harmful interference, and
- 2) this device must accept any interference received including interference that may cause undesired operation.

See user manual instructions if interference to radio reception is suspected.

### **FCC INFORMATION (U.S.A.)**

**1. IMPORTANT NOTICE: DO NOT MODIFY THIS UNIT!**

This product, when installed as indicated in the instructions contained in this manual, meets FCC requirements. Modifications not expressly approved by Yamaha may void your authority, granted by the FCC, to use the product.

**2. IMPORTANT:** When connecting this product to accessories and/or another product use only high quality shielded cables. Cable/s supplied with this product **MUST** be used. Follow all installation instructions. Failure to follow instructions could void your FCC authorization to use this product in the USA.

**3. NOTE:** This product has been tested and found to comply with the requirements listed in FCC Regulations, Part 15 for Class "B" digital devices. Compliance with these requirements provides a reasonable level of assurance that your use of this product in a residential environment will not result in harmful interference with other electronic devices. This equipment generates/uses radio frequencies and, if not installed and used according to the instructions found in the users manual, may cause interference harmful to the operation of other electronic devices. Compliance with FCC regulations does not guarantee that interference will not occur in all installations. If this product is found to be the source of interference, which can be determined by turning the product "OFF" and "ON", please try to eliminate the problem by using one of the following measures:  
Relocate either this product or the device that is being affected by the interference.  
Utilize power outlets that are on different branch (circuit breaker or fuse) circuits or install AC line filter/s.  
In the case of radio or TV interference, relocate/reorient the antenna. If the antenna lead-in is 300 ohm ribbon lead, change the lead-in to coaxial type cable.

If these corrective measures do not produce satisfactory results, please contact the local retailer authorized to distribute this type of product. If you can not locate the appropriate retailer, please contact Yamaha Electronics Corporation, USA, 6660 Orangethorpe Avenue, Buena Park, CA 90620 U.S.A.

# LASER INFORMATION

**Laser Product Class:** Class 1

**Laser Diode Properties**

**Wavelength:** 779 – 789 nm

**Pulse Durations and Max. Output**

**at the Objective Lens of the Laser Pickup Unit**

**DC Erase Mode:** Max. 20 mW (Continuous),

**Write Mode:** Max.62 mW

(Max. Cycle 111 ns, Min. Cycle 30 ns at Max. Speed)

**Laserprodukt-Klasse:** Klasse 1

**Eigenschaften der Laserdiode**

**Wellenlänge:** 779 – 789 nm

**Impulsdauer und max. Ausgang an der**

**Objektivlinse der Laser-Abtasteinheit**

**Löschmodus (Gleichstrom):** max. 20 mW (kontinuierlich),

**Schreibmodus:** max. 62 mW

(max. Zyklus 111 ns, min. Zyklus 30 ns bei maximaler Geschwindigkeit)

**Classe du produit laser:** Classe 1

**Caractéristiques de la diode laser**

**Longueur d'onde:** 779 – 789 nm

**Durée des impulsions et sortie maximum depuis**

**la lentille de focalisation du bloc capteur optique**

**Mode de suppression DC:** max. 20 mW (en continu),

**Mode de gravure:** max. 62 mW

(Cycle max. 111 ns, cycle min. 30 ns à vitesse maximale)

**Clase de producto láser:** Clase 1

**Propiedades del diodo láser**

**Longitud de onda:** 779 – 789 nm

**Duración del pulso y potencia de salida máxima**

**en el objetivo de la unidad captora de láser**

**Modo de borrado DC:** 20 mW máx. (continua),

**Modo de escritura:** máx. 62 mW

(ciclo máx. 111 ns, ciclo min. 30 ns a velocidad máxima)

**DANGER - VISIBLE AND / OR INVISIBLE LASER RADIATION WHEN OPEN. AVOID DIRECT EXPOSURE TO BEAM.**

**CLASS 1 LASER PRODUCT  
LASER KLASSE 1 PRODUKT  
LUOKAN 1 LASERLAITE  
KLASS 1 LASER APPARAT  
PRODUIT LASER DE CLASSE 1**

COMPLIES WITH 21 CFR CHAPTER 1, SUBCHAPTER J.

## CAUTION

Use of controls or adjustments or performance of procedures other than those specified herein may result in hazardous radiation exposure.

## ACHTUNG

Halten Sie sich beim Bedienen und Einstellen der Bedienungselemente sowie bei der Bedienungsabfolge an die Anleitung, da sonst gefährliche Strahlen austreten können.

## ATTENTION

L'emploi de commandes, de réglages ou un choix de procédures différents des spécifications de cette brochure peut entraîner une exposition à d'éventuelles radiations pouvant être dangereuses.

## PRECAUCION

El usar los controles o ajustar o realizar procedimientos diferentes a los especificados aquí resultará en peligrosas exposiciones a la radiación.

**VARO!** AVATTAESSA JA SUOJALUKITUS OHITETTAESSA OLET ALTINA NÄKYMÄTTÖMÄLLE LASERSÄTEILYLLE. ÄLÄ KATSO SÄTEESEEN.

**WARNING!** OSYNLIG LASERSTRÅLNING NÄR DENNA DEL ÄR ÖPPNAD OCH SPÄRREN ÄR URKOPPLAD. BETRakta EJ STRÅLEN. STRÅLEN ÄR FARLIG.

**CAUTION** - VISIBLE AND / OR INVISIBLE LASER RADIATION WHEN OPEN. AVOID EXPOSURE TO BEAM.  
**WARNING** - SYNLIG OCH / ELLER OSYNLIG LASERSTRÅLNING NÄR DENNA DEL ÄR ÖPPNAD. STRÅLEN ÄR FARLIG.  
**VARO!** AVATTAESSA OLET ALTINNA NÄKYMÄLLE JA / TAI NÄKYMÄTTÖMÄLLE LASERSÄTEILYLLE. ÄLÄ KATSO SÄTEESEEN.  
**WARNING** - SYNLIG OCH / ELLER OSYNLIG LASERSTRÅLNING NÄR DENNA DEL ÄR ÖPPNAD. BETRakta EJ STRÅLEN.  
**VORSICHT!** SICHTBARE LIND / ODER UNSICHTBARE LASERSTRÄHLUNG WENN ABECKUNG GEÖFFNET. NICHT DEM STRAHL AUSSETZEN.  
**ATTENTION** - RADIATION VISIBLE ET / OU INVISIBLE LORSQUE L'APPAREIL EST OUVERT. EVITEZ TOUTE EXPOSITION AU FAISCEAU.

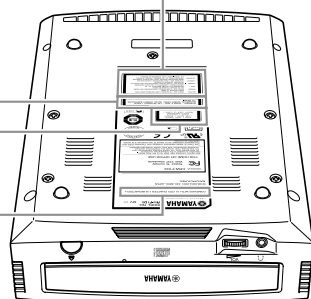



# OWNER'S MANUAL

English

EXTERNAL  
IEEE1394/USB2.0  
International

## CD-R/RW Drive **CRW-F1DX**



Advanced  
**AudioMASTER**  
QUALITY RECORDING

**DiscT@2**<sup>TM</sup>

**SafeBurn**<sup>TM</sup>



Hi-SPEED  
CENTRICE **USB**

**COMPACT**  
**disc**  
CRWWriteable



CREATING 'KANDO' TOGETHER

'KANDO' --- Inspiring the Heart and Spirit.

# SAFETY PRECAUTIONS

## PLEASE READ THE FOLLOWING WARNINGS AND CAUTIONS CAREFULLY TO PREVENT PERSONAL INJURY AND DAMAGE TO THE DEVICE.

These precautions explain how to use the device properly and safely, thereby preventing injury to yourself and others. This section has been sub-divided into a WARNING section and a CAUTION section, according to the likelihood and nature of any potential injuries or damage inflicted. They relate to your personal safety, and also help you prevent the risk of damage to the device. Please read these sections carefully prior to proceeding.



## WARNING

---

**Always follow these basic precautions to avoid short-circuit, damage, fire, or other hazards, and to avoid serious injury or fatal accident from electrical shock.**

- Do not attempt to open or disassemble the device to avoid the risk of electrical shock, fire, or malfunction.
- Do not look directly at the laser source to avoid the risk of eye damage or blindness.
- Do not insert fingers or foreign objects into the device to avoid the risk of electrical shock, fire, malfunction, or personal injury.
- Do not expose the device to high humidity or place liquid containers such as a flower vase on the device to avoid the risk of electrical shock, fire, or malfunction.
- Do not expose the device to temperature outside the range of 5 to 35 °C (41 to 95 °F) to avoid the risk of fire, deformation of the device panel, or malfunction.
- Do not expose the device to dusty place to avoid the risk of fire or malfunction.
- Always follow the owner's manual to set up or connect the devices properly to avoid the risk of electrical shock, fire, malfunction, or personal injury.
- If unusual smells, sounds or smoke come from the device, or if foreign objects such as liquid intrude into the device, turn off and unplug the computer immediately to avoid the risk of electrical shock, fire, or malfunction. Contact the store of purchase or your nearest Yamaha dealer (listed at the back of this manual).
- Be sure that the devices are electrically grounded to avoid the risk of electrical shock.

- Prior to cleaning the drive, always unplug the computer or do not handle the plug with wet hands to avoid the risk of electrical shock.
- Use the included AC adapter to avoid the risk of fire or malfunction.
- Clean the AC power plug regularly to avoid the risk of fire due to insulation failure such as humidity.
- Do not unplug the AC adapter by pulling the cable, and do not place objects on the cable to avoid the risk of electrical shock, fire, or malfunction.
- Plug in the AC adapter fully to avoid the risk of electrical shock or fire.
- Do not connect many devices to an electrical outlet. Maintain the rated power of the outlet to avoid the risk of fire due to overheating.

## CAUTION

---

**Always follow these basic precautions to avoid physical injury to yourself or others, and damage to the device or other property.**

- Always unplug the computer if it will not be used for a prolonged period or if there is a possibility of lightning, to avoid the risk of electrical shock, fire, or short-circuit.
- Do not use the device near other electrical appliances such as televisions, radios, or speakers to avoid the risk of interferences between each other.
- Do not place the device unstably to avoid the risk of malfunction or personal injury by its falling down.
- Do not place the device with a possibility of excessive vibration to avoid the risk of damage to written data or malfunction.
- Place the device horizontally to avoid the risk of damage to written data.
- Prior to transporting the device, remove the disc from the disc tray to avoid the risk of damage to written data.
- Use soft, dry cloths to wipe the device. Do not use benzene, paint thinner, detergents, or chemically treated wiped cloths, and do not place vinyl, plastic, or rubber objects on the device to avoid the risk of malfunction or damage to surface of the device.

- Do not rest your weight on or place heavy objects on the device, and do not apply excessive force to the buttons, switches, or connectors to avoid the risk of damage to the device or personal injury.
- Be careful not to short-circuit the AC power plug with metal objects to avoid the risk of malfunction.
- Do not wrap the power cable around the AC adapter to avoid the risk of breaking the wire or malfunction.
- Do not listen to audio with headphones at high volume for prolonged period to avoid auditory disorder.
- Prior to turning on the computer, always minimize the volume to avoid auditory disorder by a sudden burst of sound at high volume.
- Do not place the device near magnets or anything magnetized such as a display to avoid the risk of interferences between each other.
- Have the device serviced regularly to avoid internal dust buildup that can cause malfunction, damage or fire. For service information and service charges, contact the store of purchase or your nearest Yamaha dealer (listed at the back of this manual).



## WARRANTY

YAMAHA AND ITS SUPPLIERS ACCEPT NO LIABILITY FOR ANY PROBLEMS THAT OCCUR AS A RESULT OF ANY OPERATIONS CARRIED OUT OTHER THAN THOSE STATED IN THE MANUAL FOR THIS PRODUCT, OR THE LOSS OR THE DAMAGE OF ANY DATA CAUSED AS A RESULT OF USING THIS PRODUCT.

## Precautions for Transportation

Transporting the device unfixd may damage its internal mechanism or circuits.

- Remove the disc from the disc tray of the device.
- Put the device in the original box.

Refer to the original box to check that the complete accessories are included prior to installation.

- ©2002 YAMAHA CORPORATION. All Rights Reserved.
- This document may not, in whole or in part, be copied, photocopied, reproduced, translated, transmitted, or reduced to any electronic medium of machine readable form without prior consent in writing from Yamaha.
- Windows is a registered trademark of Microsoft Corporation.
- Apple, Macintosh, Mac OS, and FireWire are registered trademarks of Apple Computer, Inc.
- i.LINK is a trademark of Sony Corporation.
- DiscT@2™ and SafeBurn™ are trademarks of Yamaha Corporation.
- All other trademarks are the property of their respective companies. ™ and ® marks are not specified in this manual.

# Table of Contents

---

Features of the CRW-F1DX Drive .....	1
Names and Functions of Parts.....	3
Front Panel.....	3
Rear Panel.....	4
Precautions on Use .....	5
Handling Discs.....	5
Copyright .....	5
Disclaimer of Indemnity .....	5
Compatible Discs .....	6
System Requirements .....	8
Preparing the CRW-F1DX Drive .....	14
Serial Number .....	14
Connect with FireWire (IEEE1394) for Macintosh.....	15
Connect with USB for Macintosh.....	22
Connect with IEEE1394 for Windows .....	29
Connect with USB for Windows .....	35
Connecting/Disconnecting the CRW-F1DX Drive to/from the Computer ...	42
Loading/Ejecting a Disc .....	43
Troubleshooting .....	45
Firmware .....	53
CRW-F1DX Drive Specifications .....	54
Technical Notes .....	58
Buffer Underrun Protection Function .....	58
Writing Methods .....	58
IEEE1394.....	60
Connecting Multiple IEEE1394 Devices.....	61

For details about installing and using the CD writing software, refer to the instruction for it.

- The information contained in this manual is subject to change without prior notice.
- Reproduction of this manual, either in part or in full, is expressly forbidden.

# Features of the CRW-F1DX Drive

---

## Advanced Audio Master Quality Recording (High quality audio writing mode)

Audio Master Quality Recording enables you to create high quality audio CDs that can be played back beautifully on any compatible device including car stereos. In addition, the data quality of your CDs can be preserved for a long time. (P. 59)  
This mode is available for CD-R discs with a capacity of 650MB and 700MB.

## DiscT@2

The DiscT@2 function enables you to burn texts/pictures on the data surface of a CD-R disc. Writing software that supports the function is required to operate it. For details about this feature, refer to the instruction for the writing software.

### Note

- The function cannot be used with a CD-RW disc.
- Appearance of burned images such as pictures varies depending on the material of a disc.

## High speed writing/reading

The CRW-F1DX drive supports up to 44X-speed writing for CD-R discs, up to 24X-speed writing/rewriting for CD-RW discs, and up to 44X-speed data reading or digital audio data extraction. The Full CAV method enables 44X-speed writing and high fidelity stable writing at once for CD-R discs.

### Tip

The Partial CAV method (P. 60) and the Full CAV method permit 24X-speed writing/rewriting for CD-RW discs.

## SafeBurn™ (Enhanced stability writing technology)

The generous 8MB buffer memory provides sufficient data storage to enable stable disc writing at high speeds. Even if data transfer from the computer is interrupted, the Buffer Underrun Protection function is activated to save CD-R discs from a writing error. (P. 58)

“Optimum Write Speed Control” adjusts the writing speed to the optimum rate for CD-R discs automatically. The maximum writing speed can be set with CD writing software.

### Note

- “Optimum Write Speed Control” can be activated when the maximum writing speed is set at 16X or more.
- The minimum writing speed to be automatically selected is 8X. Manually set the optimum writing speed if a writing speed supported by a disc is less than 8X.

### **CD-MRW (CD Mount Rainier ReWriting)**

CD-MRW is a new standard of packet writing. Compared to the ordinary packet writing, CD-MRW provides many useful functions such as background formatting. (P. 60)

### **Dual interface**

The CRW-F1DX drive uses IEEE1394 and USB (supporting USB 2.0) for the interface. The interface adjusted to your computer environment can be easily switched by the selector.

The CRW-F1DX drive supports the hot plug function that enables you to connect/disconnect the drive while a computer is turned on.

# Names and Functions of Parts

## Front Panel

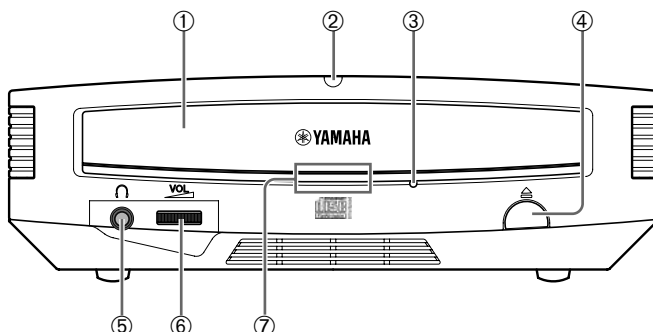

### ① Disc tray

Holds the disc. It is opened or closed by pressing the eject button. (P. 43)

### ② Power LED

Lights when the drive is turned on.

### ③ Manual eject hole

Forcibly opens the disc tray when the tray cannot be opened by pressing the eject button. (P. 44)

### ④ Eject button

Press to open or close the disc tray. (P. 43)

### ⑤ Headphone jack

Connects headphones to the drive; has stereo mini-jack specifications.

### ⑥ Headphone volume dial

Controls the volume of the headphones. The volume increases as the dial is turned to the right.

### ⑦ Status LED

Indicates the operational status of the CRW-F1DX drive by its colors and blinking patterns.

#### Lights or blinks blue

- Lights: Standby (with disc)
- Blinks: Opening/Closing disc tray, reading disc information (TOC), or playback audio
- Blinks rapidly: Reading data

#### Blinks purple

- Blinks: Accessing for writing or test writing
- Blinks rapidly: Writing

#### Blinks amber

Firmware update is incomplete. Retry to update the firmware.

#### Off

Standby (no disc) or the disc tray is open

## Rear Panel

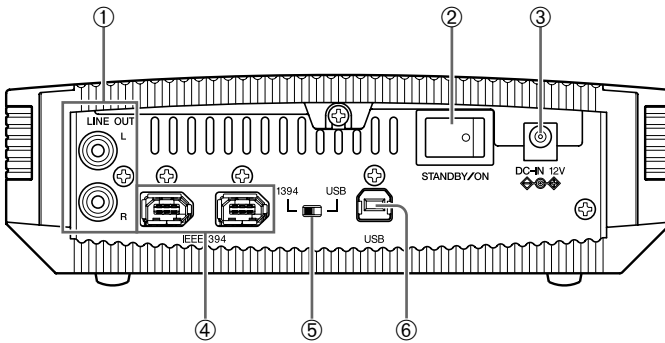

① **LINE OUT jacks (L/R)**

Connect a device such as external speakers or a sound card.

② **Power switch (STANDBY/ON)**

Turns the power on/off. (P. 15, 18)

③ **DC-IN connector**

Connects the included AC adapter. (P. 16)

④ **IEEE1394 ports**

Connect the included IEEE1394 cable.  
(P. 16 for Macintosh, P. 30 for Windows)

⑤ **1394/USB selector**

Switches interface between IEEE1394 and USB.

⑥ **USB port**

Connects the included USB cable.  
(P. 23 for Macintosh, P. 36 for Windows)

# Precautions on Use

---

## Handling Discs

Take the following precautions to avoid trouble, such as writing errors, loss of recorded data, and malfunction of the drive, when handling discs.

- Do not place discs in a hot or damp place or where they will be exposed to direct sunlight.
- Do not touch the disc surface. Hold the disc by the edge when handling it.
- Remove dust and dirt from the disc surface. Use an air spray to remove dust. The disc surface may be scratched if strongly wiped with a dry cloth.
- Do not stick labels to the disc surface or write anything on it except where designated.
- Do not clean discs with chemicals or detergents.
- Do not bend or drop discs.

## Copyright

It is prohibited by law to duplicate copyright material for non-personal use without the prior consent of the copyright holder. When copying material with your CD-R/RW drive, take due care not to infringe the copyright.

## Disclaimer of Indemnity

- Yamaha assumes no liability for the loss of any profits incurred as a result of the loss or corruption of data written on a CD-R or CD-RW, for any loss or damage caused by or arising out of extraordinary circumstances (including circumstances that Yamaha has foreseen or could foresee), nor for any damages incurred or claimed by a third party.
- After handling important data, make a comparison between the original and the copied data (to confirm that the data has been copied properly).
- In no event shall Yamaha be liable for any damage to discs due to a buffer underrun error (P. 58) or for any other reason, or the inability to use distributed discs with your drive.
- Yamaha assumes no liability for the inability to write/playback discs because of their format.

### Compatible Discs

For the latest information about compatible discs, refer to the following website.

YAMAHA CD-R/RW Drive website

URL: <http://www.yamaha.co.jp/english/product/computer/>

#### Disc shape

Circular disc 12 cm, 8 cm

Card-type disc Discs confirmed by Yamaha

#### Note

Do not use any irregular shaped discs such as heart-shaped or star-shaped discs to avoid the risk of malfunction.

#### Recordable disc type

The CRW-F1DX drive is compatible with the following discs.

---



#### CD-R discs

- Orange Book Part2 Vol.1 Version3.1-compliant discs
- Orange Book Part2 Vol.2 Version1.1-compliant discs



#### Writing speed

The writing speed settings are available in writing software.

1X, 4X, 8X, 16X, 44X

#### Note

- 44X-speed writing is enabled with the Full CAV method.
- Some writing speed settings may not be available depending on the specification of a disc.
- When the writing speed is set at 16X or 44X, "Optimum Write Speed Control" automatically adjusts the writing speed to the optimum rate for each disc within the selected writing speed.

#### Device compatibility

CD-R discs can be read/played back on a CD-ROM drive or a CD player.

---





## CD-RW discs

- Orange Book Part3 Vol.1 Version1.0-compliant discs
- Orange Book Part3 Vol.1 Version2.0-compliant discs

### Writing/Rewriting speed

The writing speed settings are available in writing software.  
2X, 4X

#### Note

- Some discs support only 2X speed.
- Some writing/rewriting speed settings may not be available depending on the specification of a disc.

### Device compatibility

CD-RW discs can be read/played back on a device that supports CD-RW discs (e.g. CD-ROM drive).



## High Speed CD-RW discs

Orange Book Part3 Vol.2-compliant discs

### Writing/Rewriting speed

The writing speed settings are available in writing software.  
4X, 10X, 12X

#### Note

- Some writing/rewriting speed settings may not be available depending on the specification of a disc.
- When using the packet writing method (P. 59) for writing/rewriting onto a High Speed CD-RW disc, you can select the 10X Full CAV method. For more details, refer to the instruction for the CD writing software. (CD writing software that has the feature to select the Full CAV method is required.)
- The Full CAV method is recommended when editing a written file with application software.

### Device compatibility

High Speed CD-RW discs can be read/played back on a CD-RW device that bears the High Speed CD-RW logo or a device that supports CD-RW discs (e.g. CD-ROM drive).

#### Note

In order to write, delete, read or play back a High Speed CD-RW disc, use a CD-R/RW drive that bears the High Speed CD-RW logo.

A CD-R/RW drive without the logo may not recognize a High Speed CD-RW disc, resulting in computer malfunction.

Refer to the Yamaha website to check the disc compatibility prior to using a YAMAHA CD-R/RW drive without the logo for a High Speed CD-RW disc.

URL: <http://www.yamaha.co.jp/english/product/computer/>



### Ultra Speed CD-RW discs

Orange Book Part3 Vol.3-compliant discs

#### Writing/Rewriting speed

The writing speed settings are available in writing software.

10X, 16X, 24X

#### Note

- 24X-speed writing/rewriting is enabled with the Partial CAV method.
- Some writing/rewriting speed settings may not be available depending on the specification of a disc.
- When using the packet writing method (P. 59) for writing/rewriting onto an Ultra Speed CD-RW disc, you can select the 24X Full CAV method. For more details, refer to the instruction for the CD writing software. (CD writing software that has the feature to select the Full CAV method is required.)
- The Full CAV method is recommended when editing a written file with application software.

#### Device compatibility

Ultra Speed CD-RW discs can be read/played back on a device that supports CD-RW discs (e.g. CD-ROM drive) or a device that bears the High/Ultra Speed CD-RW logo.

#### Note

In order to write or delete an Ultra Speed CD-RW disc, use a CD-RW drive that bears the Ultra Speed CD-RW logo.

A CD-R/RW drive without the logo may not recognize a High/Ultra Speed CD-RW disc, resulting in computer malfunction.

Refer to the Yamaha website to check the disc compatibility prior to using a YAMAHA CD-R/RW drive without the logo for a High/Ultra Speed CD-RW disc.

URL: <http://www.yamaha.co.jp/english/product/computer/>

---

## System Requirements

The CRW-F1DX drive is designed to operate in the following computer environment. If your computer does not meet these requirements, the CRW-F1DX drive may not operate or write at the maximum speed.

### For Macintosh

#### Computer (Macintosh)

- CPU: PowerPC G3, 300 MHz or faster
- RAM: 64MB or more
- Macintosh standard FireWire port
- Macintosh standard USB port

## Connecting the drive to a USB port

When the CRW-F1DX drive is connected to a Macintosh standard USB port, the drive operates with USB 1.1 specifications.

For secure data writing, activate Buffer Underrun Protection and set the writing speed to 8X for a CD-R disc or 10X for a CD-RW disc with the writing software. The actual writing/rewriting speed is approximately 6X. The data reading speed is up to 6X.

- CD-ROM drive

### **Note**

The CRW-F1DX drive cannot be used to boot the computer or to set up an operating system.

- Hard drive space

Writing data on a CD-R/RW disc requires 50MB to 100MB of free space as a working area on the hard drive. When writing data on a CD-R/RW disc after creating image file, there must be enough free space on the hard drive to store the image file in addition to the working area (a total of up to 1.1GB).

However, hard drive space for image file is not required when directly writing onto a CD-R/RW disc from hard drive or CD-ROM using the CRW-F1DX drive (on-the-fly writing).

## Image file

An image file is data files that are collected to be written on a CD-R/RW disc. The file is useful for writing the same data onto multiple discs. For details, refer to the instruction for the CD writing software.

## IEEE1394 cable

The IEEE1394 standard for maximum length of cable between devices is 4.5 meters. The length of the included IEEE1394 cable is one meter.

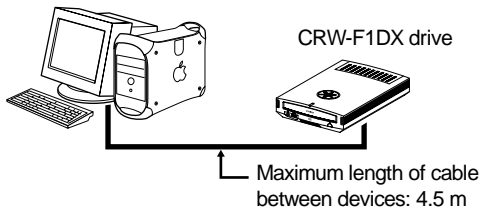

Continued on next page

## Precautions on Use

### USB cable

The USB standard for maximum length of cable between devices is five meters. The length of the included USB cable is one meter.

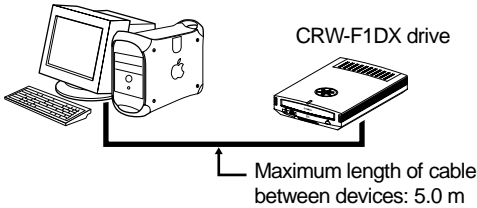

### Operating system

Mac OS 9.1, 9.2 and Mac OS X (min. v10.1.2)

### CD writing software

The CRW-F1DX drive requires CD writing software to write onto a CD-R/RW disc. Use the CD writing software that supports the CRW-F1DX drive. For details about installing and using the CD writing software, refer to the instruction for it.

## For Windows

### Computer (PC/AT compatible)

- CPU: Pentium II-class or higher, 300 MHz or faster
- RAM: 64MB or more  
64MB or more is required (128MB is recommended) for Windows 2000 Professional, while 128MB or more is required (256MB is recommended) for Windows XP.
- CD-ROM drive

#### Note

- A CD-ROM drive other than the CRW-F1DX drive is required to install the device drivers (for USB connection).
- The CRW-F1DX drive cannot be used to boot the computer or to set up an operating system.

- Hard drive space

Writing data on a CD-R/RW disc requires 50MB to 100MB of free space as a working area on the hard drive. When writing data on a CD-R/RW disc after creating an image file, there must be enough free space on the hard drive to store the image file in addition to the working area (a total of up to 1.1GB).

However, hard drive space for image files is not required when directly writing onto a CD-R/RW disc from a hard drive or CD-ROM using the CRW-F1DX drive (on-the-fly writing).

### Image file

An image file is data files that are collected to be written on a CD-R/RW disc. The file is useful for writing the same data onto multiple discs. For details, refer to the instruction for the CD writing software.

### For IEEE1394 connection

- A spare PCI expansion slot or a CardBus slot to install an IEEE1394 interface card (if one has not been installed)
- IEEE1394 port

An optional IEEE1394 interface card (OHCI compatible) is required to connect the CRW-F1DX drive for the computer without an IEEE1394 port.

The IEEE1394 interface cards that have been already recognized to support the CRW-F1DX drive are as follows.

Manufacture	Product	Card Type
Adaptec	AFW-4300	PCI
SIIG	1394FireWire (NN-400P22)	PCI

For the latest information about IEEE1394 interface cards supporting the CRW-F1DX drive, refer to the following websites.

YAMAHA CD-R/RW Drive website

URL: <http://www.yamaha.co.jp/english/product/computer/>

### Note

Some IEEE1394 interface cards may not support the CRW-F1DX drive. Even if the interface card operates properly in the computer, the interface card may not support IEEE1394 interface CD-R/RW drives. For details, refer to the instruction for the IEEE1394 interface card.

Yamaha recommends that you use an IEEE1394 interface card listed above that has been recognized to support the CRW-F1DX drive.

Continued on next page

### IEEE1394 cable

The IEEE1394 standard for maximum length of cable between devices is 4.5 meters. The length of the included IEEE1394 cable is one meter.

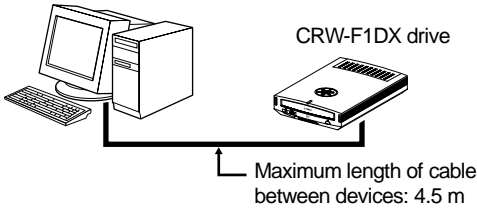

### For USB connection

- A spare PCI expansion slot or a CardBus slot to install a USB 2.0 interface card (if one has not been installed)
- USB port (USB 2.0 compatible)

A USB port is required to connect the CRW-F1DX drive to the computer. The CRW-F1DX drive needs to be connected to the USB port on the computer. The drive connected to the computer via a USB hub may not operate properly.

To fully utilize the CRW-F1DX drive, a USB 2.0 port and EHCI (Enhanced Host Controller Interface) compliant driver are required.

If a computer has a USB port with USB 1.1 specifications, Yamaha recommends that a USB 2.0 interface card be installed in the computer.

The USB 2.0 interface card that has been already recognized to support the CRW-F1DX drive is as follows.

Manufacture	Product	Card Type
Adaptec	AUA-3100LP	PCI

For the latest information about USB 2.0 interface cards supporting the CRW-F1DX drive, refer to the following websites.

YAMAHA CD-R/RW Drive website

URL: <http://www.yamaha.co.jp/english/product/computer/>

### Note

For information about where to find an EHCI compliant driver for the USB 2.0 interface card or information about operating systems supporting the card, refer to the card manufacturer's website or contact the manufacturer.

---

### Connecting the drive to a USB port with USB 1.1 specifications

When the CRW-F1DX drive is connected to a USB 1.1-compliant port on the computer, the drive operates with USB 1.1 specifications.

For secure data writing, activate Buffer Underrun Protection and set the writing speed to 8X for a CD-R disc or 10X for a CD-RW disc with the writing software. The actual writing/rewriting speed is approximately 6X. The data reading speed is up to 6X.

### USB cable

The USB standard for maximum length of cable between devices is five meters.

The length of the included USB cable is one meter.

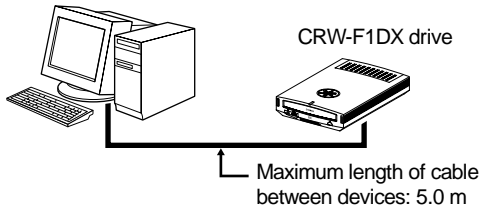

### **Operating system**

Windows 98 Second Edition, Windows Me, Windows 2000 Professional, Windows XP (Home Edition/Professional Edition)

### **CD writing software**

The CRW-F1DX drive requires CD writing software to write onto a CD-R/RW disc.

Use the CD writing software that supports the CRW-F1DX drive.

For details about installing and using the CD writing software, refer to the instruction for it.

# Preparing the CRW-F1DX Drive

## Serial Number

The serial number, printed on the label on the bottom of your CRW-F1DX drive, is required when you have a question about the drive or need user support services. Please write the serial number down in the space below. It may be difficult to check the serial number after setting up the drive or for any other reason.

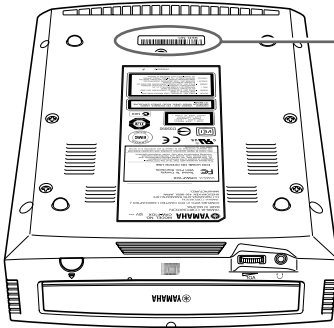

Serial number  
(10 characters: 3 letters +  
7 numbers)

Serial Number									
---------------	--	--	--	--	--	--	--	--	--



## Connect with FireWire (IEEE1394) for Macintosh

### Note

Place the CRW-F1DX drive horizontally.

- 1 **Remove all additional FireWire (IEEE1394) devices connected to the computer, and turn on the computer.**
- 2 **Be sure that the power switch of the CRW-F1DX drive is turned off (STANDBY).**

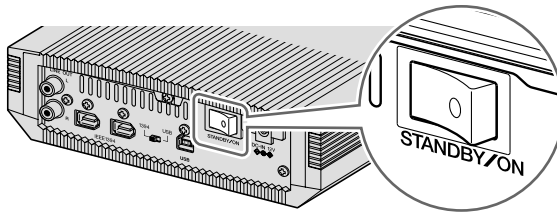

- 3 **Set the 1394/USB selector of the CRW-F1DX drive to IEEE1394.**

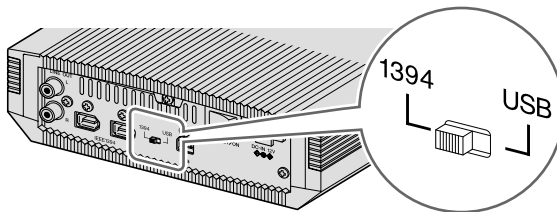

### Note

Be sure to set the 1394/USB selector while the power switch of the CRW-F1DX is turned off (STANDBY). Interface cannot be switched if the power switch is on.

**4** Connect the included IEEE1394 cable to the CRW-F1DX drive.

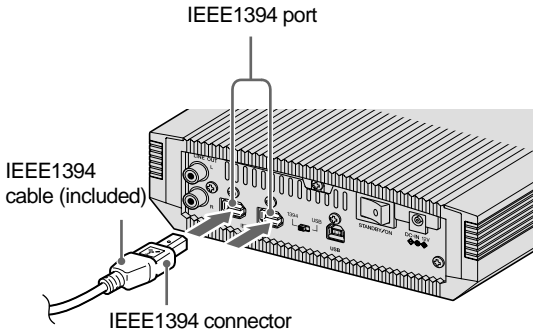

**Note**

The IEEE1394 cable can be connected to either IEEE1394 port of the CRW-F1DX drive.

**5** Connect the included AC adapter to the DC-IN connector of the CRW-F1DX drive.

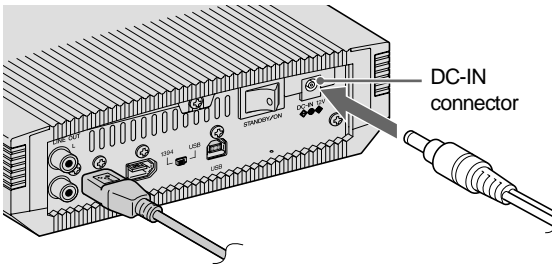

- 
- 6 **Connect the included power cable to the AC adapter (①).  
Connect the other end of the power cable to the wall socket (②).**

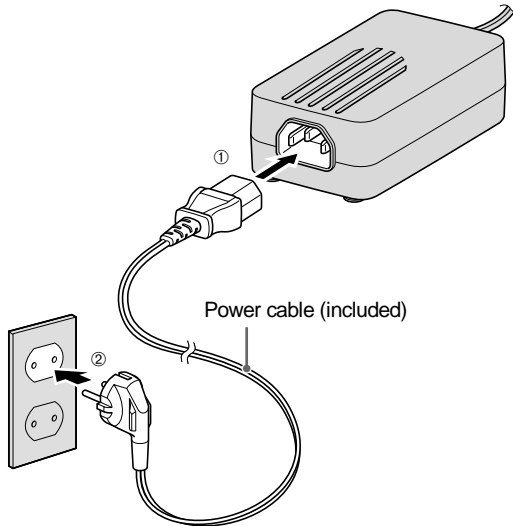

**Note**

- Use the included AC adapter only. Do not use other adapters.
  - The AC adapter may become warm during use under normal conditions.
  - The AC adapter consumes 1 W of power while connected to the wall socket even if the power switch of the CRW-F1DX drive is turned off. Remove the power cable from the wall socket when not using the CRW-F1DX drive for a prolonged period.
-

**7 Turn on the power switch of the CRW-F1DX drive.**

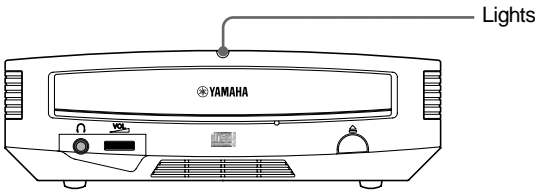
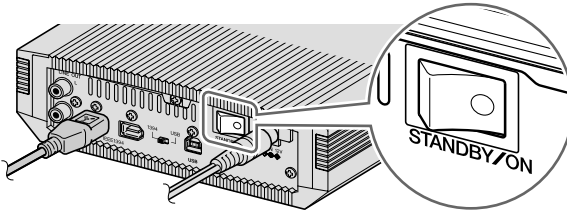

**Note**

When turning on the CRW-F1DX drive, be sure that the power LED lights. (P. 3)

**8 Connect the included IEEE1394 cable to the computer.**

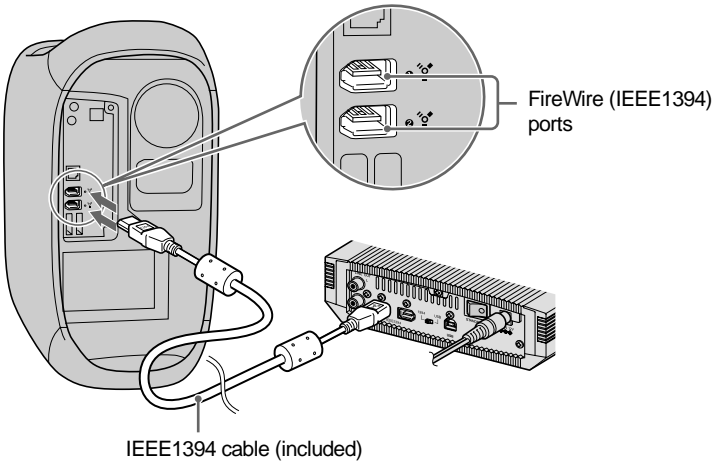

**Note**

To connect multiple FireWire (IEEE1394) devices, refer to “Connecting Multiple IEEE1394 Devices.” (P. 61)

**9 Check recognition of the CRW-F1DX drive.**

After connecting the CRW-F1DX drive to the computer, follow the steps below to check that the drive is recognized by the computer properly.

**For Mac OS 9.1 and 9.2**

- 1 Select the Apple menu in the menu bar, then **Apple System Profiler** and **Device and Volume** tab.
- 2 Check that “fw609e” and “sbp609e” (or “CRW-F1E” in some versions) are shown in the “FireWire” column.  
The FireWire version is shown in this window.

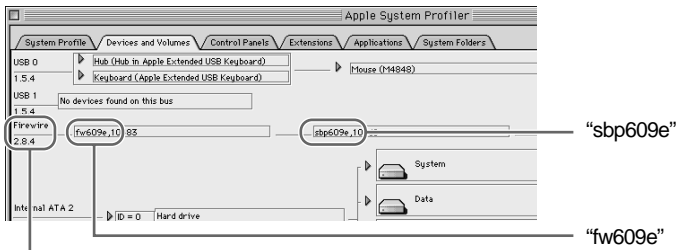

The FireWire version is shown.

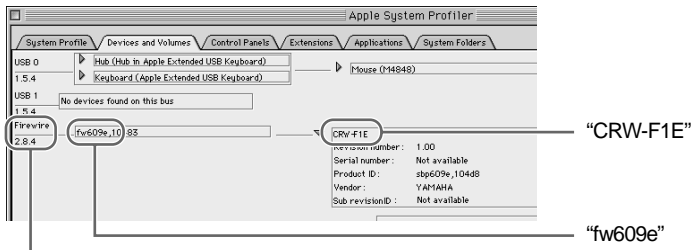

The FireWire version is shown.

Continued on next page

### Note

- In the case that other FireWire storage devices such as a hard drive or an MO drive are connected to the computer, “fw609e” and “sbp609e” are shown in the column when any device is recognized. To check that the CRW-F1DX drive is recognized properly, un-mount icons of those devices, and then remove those devices temporarily.
- If the “FireWire” item is not shown, the FireWire interface of the computer is not recognized by the Mac OS. Contact the manufacturer of the computer.
- If the “fw609e” and “sbp609e” (or “CRW-F1E” in some versions) are not shown even with the “FireWire” item shown, the CRW-F1DX drive is not recognized by the Mac OS. In such a case, contact the store of purchase or your nearest Yamaha dealer (listed at the back of this manual).
- The FireWire version in Mac OS that supports the CRW-F1DX drive is 2.0 or later.
- The extension files that support the CRW-F1DX drive are required to mount and read the disc even if the drive is recognized by Apple System Profiler. The extension files come with the CD writing software. For details, refer to the instruction for the CD writing software.

### For Mac OS X

- 1 Select **Go** in the menu bar, then **Applications**, **Utilities**, **Apple System Profiler**, and **Device and Volume** tab.

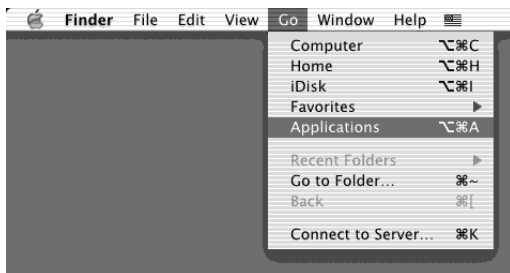

---

## 2 Check that “CRW-F1DX” is shown in the “FireWire” item.

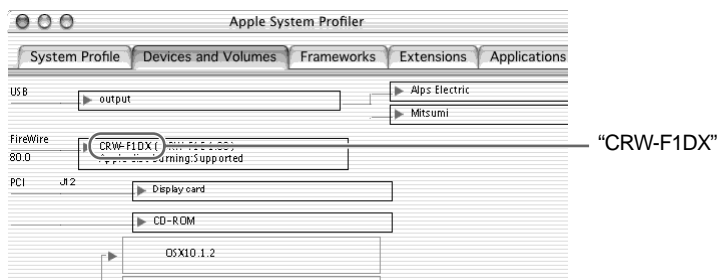

### Note

- If the “FireWire” item is not shown, the FireWire interface of the computer is not recognized by the Mac OS X. Contact the manufacturer of the computer.
- If “CRW-F1DX” is not shown even with the “FireWire” item shown, the CRW-F1DX drive is not recognized by Mac OS. In such a case contact the store of purchase or your nearest Yamaha dealer (listed at the back of this manual).

---

## 10 Install the CD writing software.

Install the CD writing software. For details about how to install the CD writing software, refer to the instruction for it.

---

“CRW-F1E” (device name) corresponding to the CRW-F1DX drive (product name) will be shown on your CD writing software when the drive is recognized by the CD writing software properly.

For details about how to check recognition of the CRW-F1DX drive with the CD writing software, refer to the instruction for the CD writing software.

## Connect with USB for Macintosh

**Note**

Place the CRW-F1DX drive horizontally.

- 1 Remove all additional USB devices connected to the computer, and turn on the computer.**
- 2 Be sure that the power switch of the CRW-F1DX drive is turned off (STANDBY).**

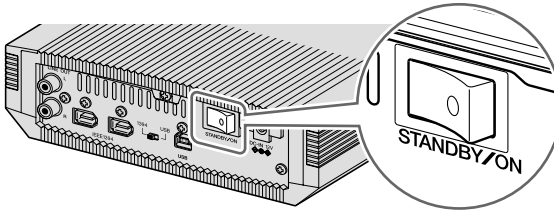

- 3 Set the 1394/USB selector of the CRW-F1DX drive to USB.**

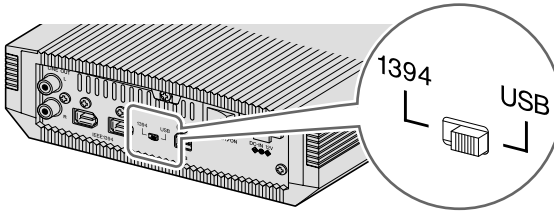

**Note**

Be sure to set the 1394/USB selector while the power switch of the CRW-F1DX is turned off (STANDBY). Interface cannot be switched if the power switch is on.



---

#### 4 **Connect the included USB cable to the CRW-F1DX drive.**

The included USB cable has two types of plugs: Series A plug and Series B plug.

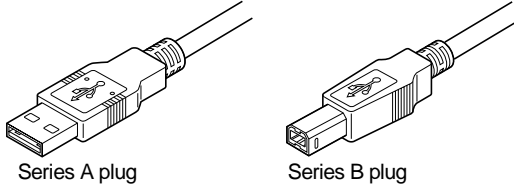

Insert the Series B plug (with a quadratic section) of the included USB cable to the USB port of the CRW-F1DX drive.

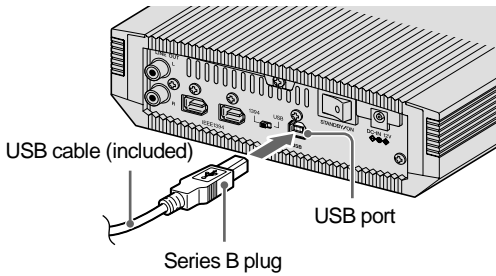

---

#### 5 **Connect the included AC adapter to the DC-IN connector of the CRW-F1DX drive.**

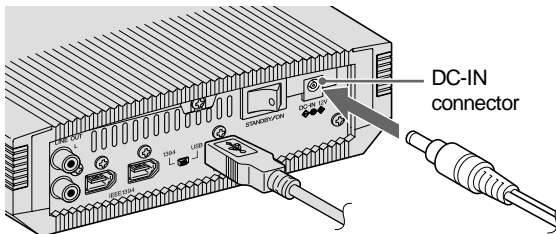

- 6 **Connect the included power cable to the AC adapter (①).  
Connect the other end of the power cable to the wall socket (②).**

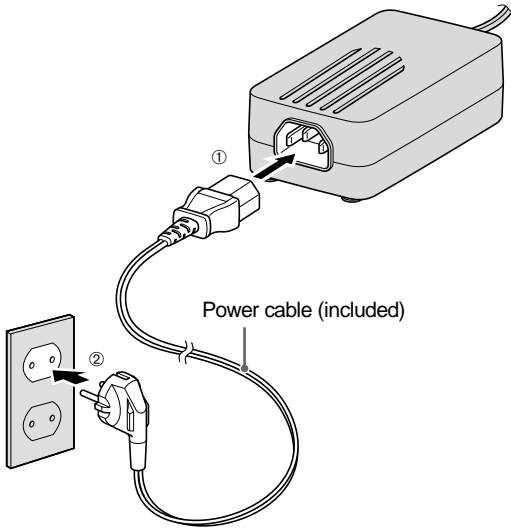

**Note**

- Use the included AC adapter only. Do not use other adapters.
  - The AC adapter may become warm during use under normal conditions.
  - The AC adapter consumes 1 W of power while connected to the wall socket even if the power switch of the CRW-F1DX drive is turned off. Remove the power cable from the wall socket when not using the CRW-F1DX drive for a prolonged period.
-

---

**7 Turn on the power switch of the CRW-F1DX drive.**

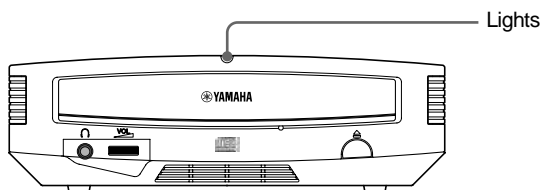
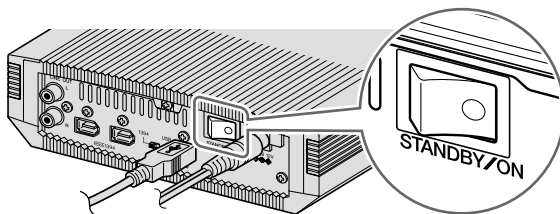

**Note**

When turning on the CRW-F1DX drive, be sure that the power LED lights. (P. 3)

---

**8 Connect the included USB cable to the computer.**

Connect the Series A plug (with a rectangular section) of the included USB cable to the Macintosh standard USB port.

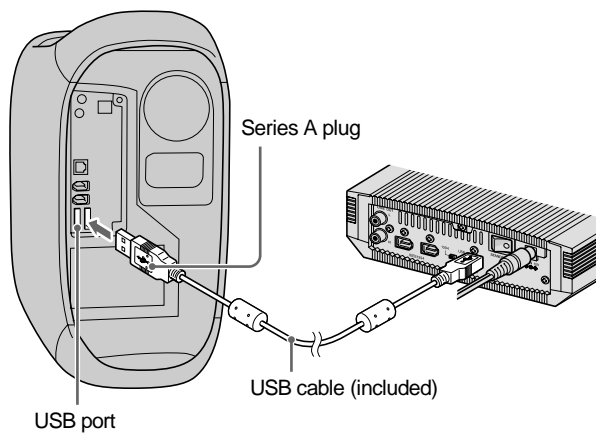

Continued on next page

### Note

- The CRW-F1DX drive is required to be connected to the USB port on the computer. The drive connected to the computer via a USB hub or a USB keyboard may not operate properly.
- When the CRW-F1DX drive is connected to a Macintosh standard USB port, the drive operates with USB 1.1 specifications. (P. 9)

## 9 Check recognition of the CRW-F1DX drive.

After connecting the CRW-F1DX drive to the computer, follow the steps below to check that the drive is recognized by the computer properly.

### For Mac OS 9.1 and 9.2

- 1 Select the Apple menu in the menu bar, then **Apple System Profiler** and **Device and Volume** tab.
- 2 Check that “CRW-F1DX” is shown in the “USB” item.

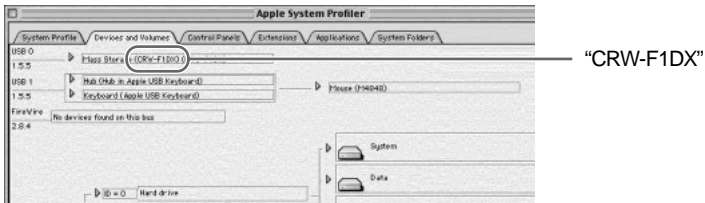

### Note

- If the “USB” item is not shown, the USB interface of the computer is not recognized by the Mac OS. Contact the manufacturer of the computer.
- If “CRW-F1DX” is not shown even with the “USB” item shown, the CRW-F1DX drive is not recognized by the Mac OS. In such a case, contact the store of purchase or your nearest Yamaha dealer (listed at the back of this manual).
- The USB version in Mac OS that supports the CRW-F1DX drive is 1.2 or later.
- The extension files that support the CRW-F1DX drive are required to mount and read the disc even if the drive is recognized by Apple System Profiler. The extension files come with the CD writing software. For details, refer to the instruction for the CD writing software.

## For Mac OS X

- 1 Select **Go** in the menu bar, then **Applications, Utilities, Apple System Profiler, and Device and Volume** tab.

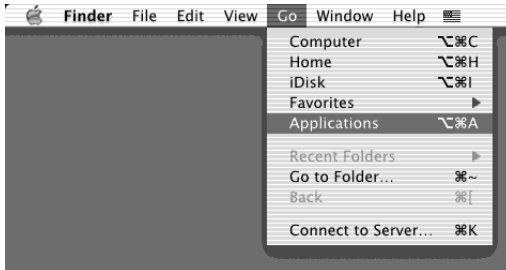

- 2 Check that “YAMAHA (CRW-F1E)” is shown in the “USB” item.

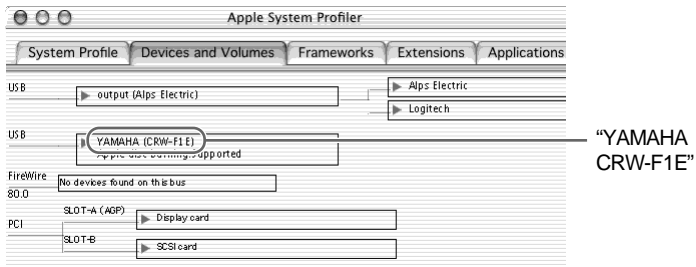

### Note

- If the “USB” item is not shown, the USB interface of the computer is not recognized by the Mac OS X. Contact the manufacturer of the computer.
- If “YAMAHA CRW-F1E” is not shown even with the “USB” item shown, the CRW-F1DX drive is not recognized by Mac OS. In such a case contact the store of purchase or your nearest Yamaha dealer (listed at the back of this manual).

## **10 Install the CD writing software.**

Install the CD writing software. For details about how to install the CD writing software, refer to the instruction for it.

---

“CRW-F1E” (device name) corresponding to the CRW-F1DX drive (product name) will be shown on your CD writing software when the drive is recognized by the CD writing software properly.

For details about how to check recognition of the CRW-F1DX drive with the CD writing software, refer to the instruction for the CD writing software.

## Connect with IEEE1394 for Windows

### Note

Place the CRW-F1DX drive horizontally.

- 1 **Remove all additional IEEE1394 devices connected to the computer, and turn on the computer.**
- 2 **Be sure that the power switch of the CRW-F1DX drive is turned off (STANDBY).**

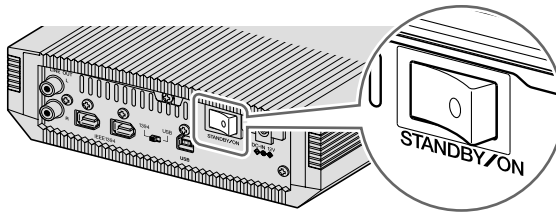

- 3 **Set the 1394/USB selector of the CRW-F1DX drive to IEEE1394.**

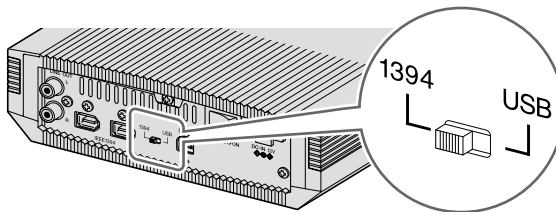

### Note

Be sure to set the 1394/USB selector while the power switch of the CRW-F1DX is turned off (STANDBY). Interface cannot be switched if the power switch is on.

**4 Connect the included IEEE1394 cable to the CRW-F1DX drive.**

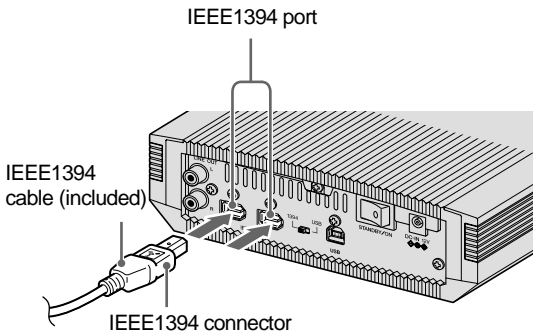

**Note**

- The included IEEE1394 cable has a 6-pin IEEE1394 connector at each end. Depending on your computer environment such as a laptop computer with a 4-pin type IEEE1394 port, an IEEE1394 cable with a 4-pin IEEE1394 connector at one end may be required.

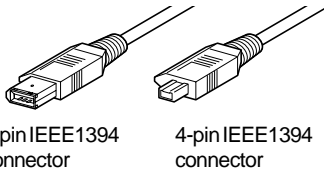

- The IEEE1394 cable can be connected to either IEEE1394 port of the CRW-F1DX drive.

**5 Connect the included AC adapter to the DC-IN connector of the CRW-F1DX drive.**

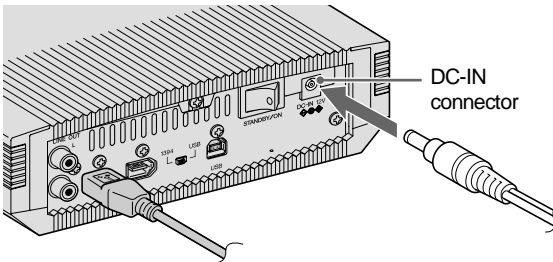



- 
- 6 **Connect the included power cable to the AC adapter (①).  
Connect the other end of the power cable to the wall socket (②).**

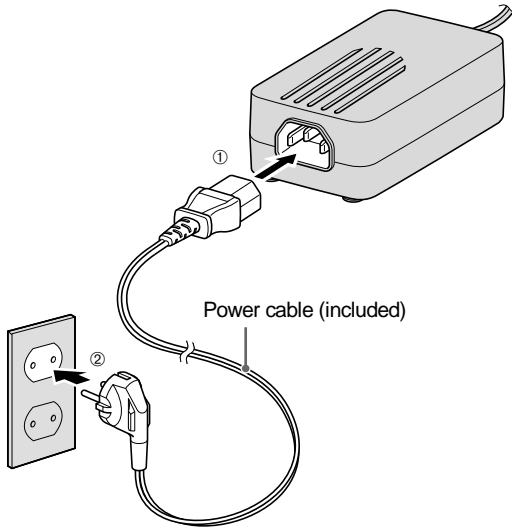

**Note**

- Use the included AC adapter only. Do not use other adapters.
  - The AC adapter may become warm during use under normal conditions.
  - The AC adapter consumes 1 W of power while connected to the wall socket even if the power switch of the CRW-F1DX drive is turned off. Remove the power cable from the wall socket when not using the CRW-F1DX drive for a prolonged period.
-

**7 Turn on the power switch of the CRW-F1DX drive.**

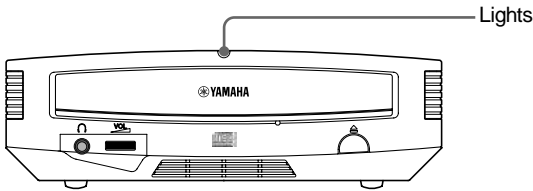
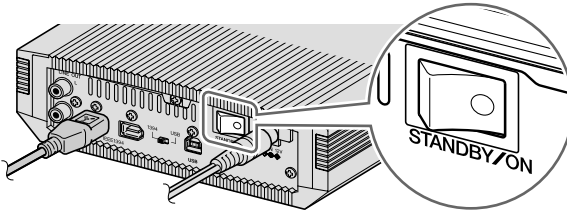

**Note**

When turning on the CRW-F1DX drive, be sure that the power LED lights. (P. 3)

---

**8 Connect the included IEEE1394 cable to the computer.**

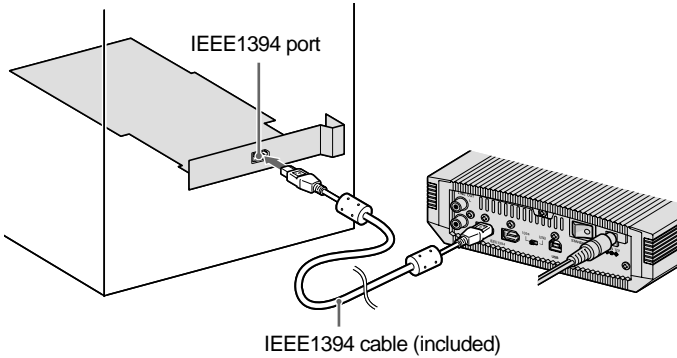

**Note**

To connect multiple IEEE1394 devices, refer to “Connecting Multiple IEEE1394 Devices.” (P. 61)

---

## 9 Check recognition of the CRW-F1DX drive.

After connecting the CRW-F1DX drive to the computer, follow the steps below to check that the drive is recognized properly by the computer.

### For Windows XP

- 1 Select **Start** on the task bar, then **Control Panel**, **System**, **Hardware** tab, and **Device Manager**. The **Device Manager** dialog box appears.

#### Note

If the **System** icon is not shown in the **Control Panel** window, click **Switch to Classic View** on the left side of the window.

- 2 Check that the following icons are shown.

- a: “YAMAHA CRW-F1DX IEEE 1394 SBP2 Device” in the “DVD/CD-ROM drives” item
- b: “IEEE 1394 Bus host controllers”
- c: “SBP2 Compliant IEEE 1394 device” in the “SBP2 IEEE 1394 Devices” item

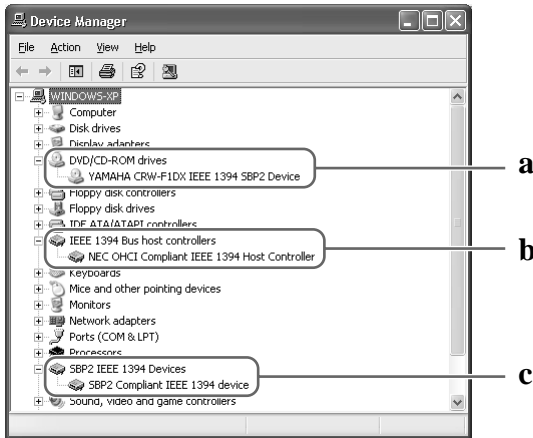

The drive name is not shown or there is **!** or **X** mark.

The CRW-F1DX drive has not been recognized properly. Check the cable connections and settings.

Continued on next page

### For Windows 2000 Professional

- 1 Select **Start** on the task bar, then **Settings, Control Panel, System, Hardware** tab, and **Device Manager**. The **Device Manager** dialog box appears.
- 2 Check that the following icons are shown.
  - a: “YAMAHA CRW-F1DX IEEE 1394 SBP2 Device” in the “DVD/CD-ROM drives” item
  - b: “IEEE 1394 Bus host controllers”

### For Windows 98 Second Edition/Me

- 1 Select **Start** on the task bar, then **Settings, Control Panel, System, and Device Manager** tab. The **Device Manager** dialog box appears.

#### Note

For Windows Me, if the **System** icon is not found in the **Control Panel** window, click **view all Control Panel options** on the left side of the window.

- 2 Check that the following icons are shown.
  - a: “1394 Bus Controller”
  - b: “YAMAHA CRW-F1E” in the “CDROM” item
  - c: “SBP2”

---

## 10 Install CD writing software.

Install the CD writing software. For details about installing CD writing software, refer to the instruction for it.

---

## Connect with USB for Windows

### Note

Place the CRW-F1DX drive horizontally.

- 1 **Remove all additional USB devices connected to the computer, and turn on the computer.**
- 2 **Be sure that the power switch of the CRW-F1DX drive is turned off (STANDBY).**

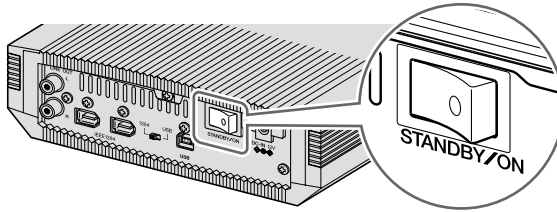

- 3 **Set the 1394/USB selector of the CRW-F1DX drive to USB.**

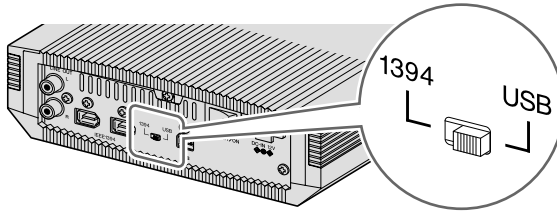

### Note

Be sure to set the 1394/USB selector while the power switch of the CRW-F1DX is turned off (STANDBY). Interface cannot be switched if the power switch is on.

**4 Connect the included USB cable to the CRW-F1DX drive.**

The included USB cable has two types of plugs: Series A plug and Series B plug.

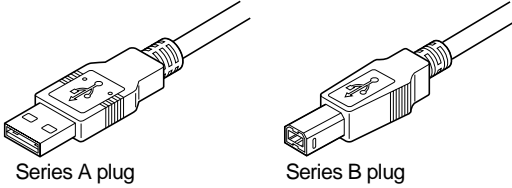

Insert the Series B plug (with a quadratic section) of the included USB cable to the USB port of the CRW-F1DX drive.

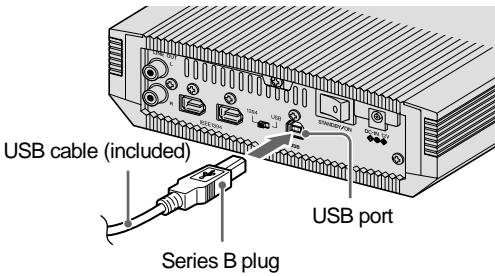

**5 Connect the included AC adapter to the DC-IN connector of the CRW-F1DX drive.**

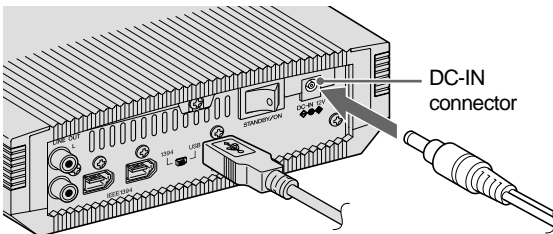

- 
- 6 **Connect the included power cable to the AC adapter (①).  
Connect the other end of the power cable to the wall socket (②).**

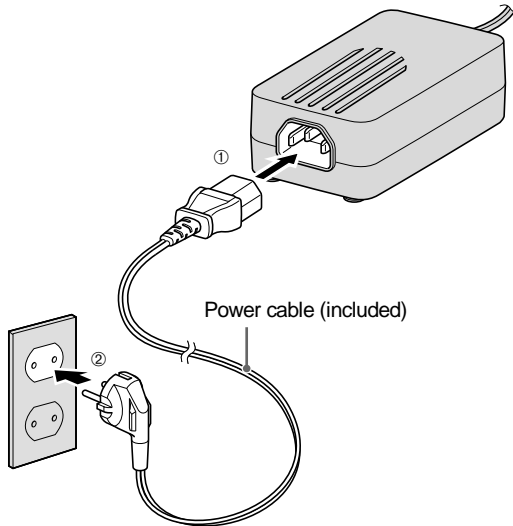

**Note**

- Use the included AC adapter only. Do not use other adapters.
  - The AC adapter may become warm during use under normal conditions.
  - The AC adapter consumes 1 W of power while connected to the wall socket even if the power switch of the CRW-F1DX drive is turned off. Remove the power cable from the wall socket when not using the CRW-F1DX drive for a prolonged period.
-

**7 Turn on the power switch of the CRW-F1DX drive.**

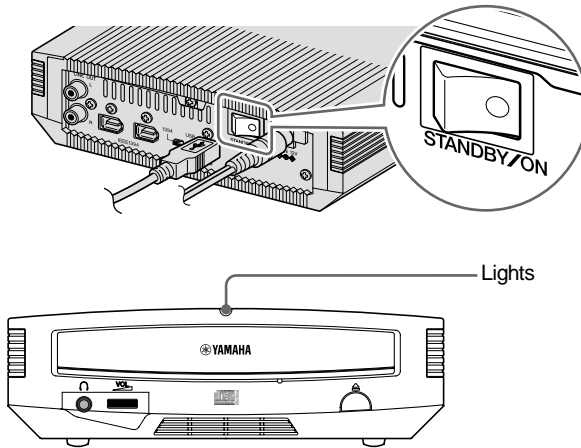

**Note**

When turning on the CRW-F1DX drive, be sure that the power LED lights. (P. 3)

**8 Connect the included USB cable to the computer.**

Connect the Series A plug (with a rectangular section) of the included USB cable to the USB port of the USB interface card.

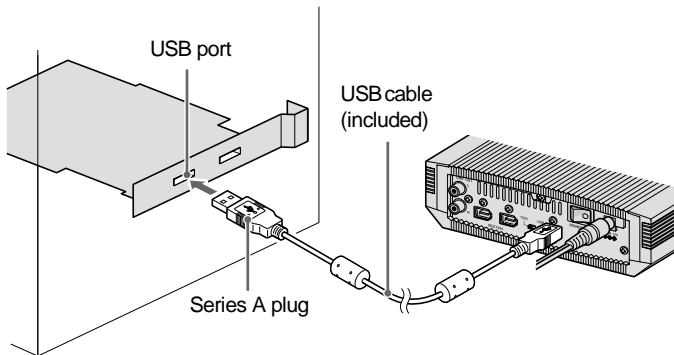



---

**Note**

- The CRW-F1DX drive is required to be connected to the USB port on the computer. The drive connected to the computer via a USB hub may not operate properly.
- When the CRW-F1DX drive is connected to a USB 1.1-compliant port on the computer, the drive operates with USB 1.1 specifications. (P. 13)

---

## 9 Install the Device Drivers.

Installation of the device drivers starts automatically when the CRW-F1DX drive is connected to the computer.

The device drivers need to be installed only once when first installing the device.

### For Windows XP/2000 Professional/Me

The device drivers of the operating system standard are installed automatically.

### For Windows 98 Second Edition

Install the device drivers with the included CD-ROM “CRW-F1 SOFTWARE DISC.”

For details, refer to the separate manual “Windows 98 Second Edition USB CD-ROM Device Driver Installation Guide” for the CRW-F1DX drive.

**Note**

The device drivers are required to be installed for each USB port. If the drive is connected to a USB port where the device drivers have not yet been installed, a message to install the device driver will be shown.

---

## 10 Check Recognition of the CRW-F1DX Drive.

After connecting the CRW-F1DX drive to the computer, follow the steps below to check that the drive is recognized properly by the computer.

### For Windows XP

- 1 Select **Start** on the task bar, then **Control Panel**, **System**, **Hardware** tab, and **Device Manager**. The **Device Manager** dialog box appears.

**Note**

If the **System** icon is not shown in the **Control Panel** window, click **Switch to Classic View** on the left side of the window.

Continued on next page

- 2 Check that the following icons are shown.
  - a: “YAMAHA CRW-F1E USB Device” in the “DVD/CD-ROM drives” item.
  - b: “USB Mass Storage Device” in the “Universal Serial Bus controllers” item.

Figure 1

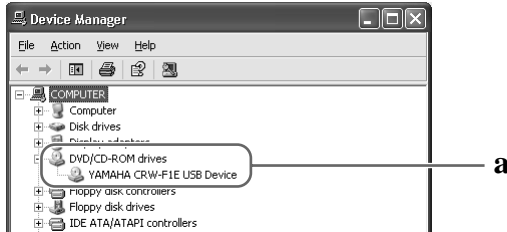
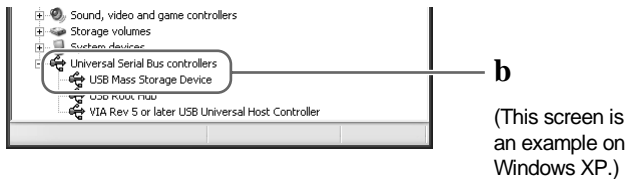



Figure 2 (scroll down)



The drive name is not shown or there is  or  mark.

The CRW-F1DX drive has not been recognized properly. Check the cable connections and settings. In some computer environments, a green  mark may appear on the left side of checking icons. This is not a malfunction.

### For Windows 2000 Professional

- 1 Select **Start** on the task bar, then **Settings, Control Panel, System, Hardware** tab, and **Device Manager**. The **Device Manager** dialog box appears.
- 2 Check that the following icons are shown.
  - a: “YAMAHA CRW-F1E USB Device” in the “DVD/CD-ROM drives” item.
  - b: “USB Mass Storage Device” in the “Universal Serial Bus controllers” item.

---

### For Windows 98 Second Edition/Me

- 1 Select **Start** on the task bar, then **Settings, Control Panel, System,** and **Device Manager** tab. The **Device Manager** dialog box appears.

#### **Note**

For Windows Me, if the **System** icon is not found in the **Control Panel** window, click **view all Control Panel options** on the left side of the window.

- 2 Check that the following icons are shown.
  - a: “YAMAHA CRW-F1E” in the “CDROM” item.
  - b: “USB CD-ROM” in the “Storage device” item.
  - c: “USB Mass Storage Device” in the “Universal Serial Bus controllers” item.

---

### 1 1 **Install CD Writing Software.**

Install the CD writing software. For details about installing the CD writing software, refer to the instruction for it.

---

# Connecting/Disconnecting the CRW-F1DX Drive to/from the Computer

---

The CRW-F1DX drive can be connected/disconnected whether the computer and the drive are turned on or off (hot plug).

However, follow the steps below to disconnect the CRW-F1DX drive from the computer turned on or to turn off the drive connected to the computer.

- 1 Quit the writing software and the playback software if they are activated.
- 2 Be sure to remove any disc from the disc tray.

## For Macintosh

Disconnect the CRW-F1DX drive.

## For Windows XP

Select **Safely Remove Hardware** on the task bar and follow the steps on the screen to disconnect the drive.



(This screen is an example on Windows XP.)

## For Windows 2000 Professional/Me

Select **Unplug or Eject Hardware** on the task bar and follow the steps on the screen to remove the drive.

## For Windows 98 Second Edition

Disconnect the CRW-F1DX drive.

### Note

- Be sure not to disconnect the CRW-F1DX drive or connect/disconnect other IEEE1394/USB devices from the computer when writing with the drive.
- When connecting with IEEE1394 for Windows 98 Second Edition, do not disconnect IEEE1394 device from the computer turned on to avoid improper operation.

When connecting with IEEE1394, be sure not to turn off the CRW-F1DX connected to the computer turned on. The computer or other IEEE1394 devices may not operate properly depending on a type of host adapter or a CD writing software. Disconnect the CRW-F1DX drive from the computer prior to turning off the drive.

# Loading/Ejecting a Disc

---

Prior to the operation, check that the CRW-F1DX drive is turned on.

---

- 1 Open the disc tray by pressing the eject button.**

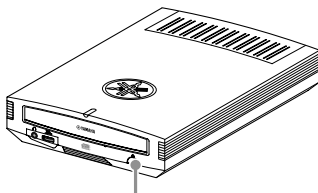

Press the eject button

---

- 2 Place the disc onto the disc tray properly with its label facing upward.**

Or remove the disc from the disc tray carefully so not to damage it.

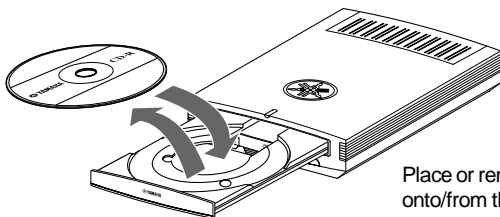

Place or remove the disc  
onto/from the disc tray

---

- 3 Close the disc tray by pressing the eject button or by gently pushing the disc tray into the drive.**
- 

## Note

- Place or remove the disc after the disc tray has fully opened. Do not push or pull the disc tray with applying excessive force to avoid damage to the drive or the disc.
- The disc tray does not open while the application software prohibits ejecting, including when the drive accesses the disc.

### Manually Ejecting a Disc

If the disc tray fails to open for some reason, such as a power failure, follow the steps below to remove the disc from the drive.

**Note**

Frequent use of this operation may cause malfunction of the drive.

---

**1 Prepare a thin pin-like object, such as a straightened paper clip.**

Use an object less than 2 mm in diameter and more than 3 cm in length.

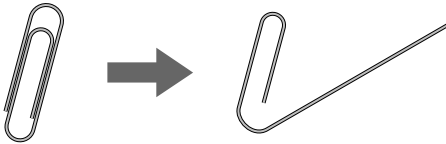

---

**2 Turn off the CRW-F1DX drive.**

---

**3 Insert the thin pin-like object straight into the manual eject hole, and push it in.**

When the disc tray opens, remove the disc.

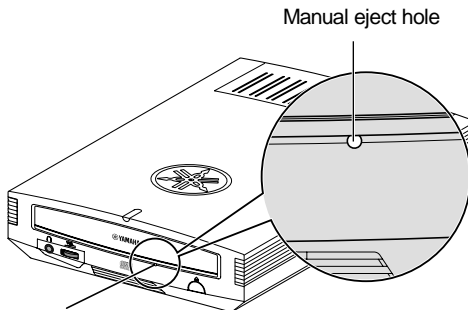

---

**4 Turn on the CRW-F1DX drive, and close the disc tray.**

---

# Troubleshooting

---

Refer to the YAMAHA CD-R/RW Drive website for the latest support information, including the troubleshooting guide.

**YAMAHA CD-R/RW Drive website**

**URL:** <http://www.yamaha.co.jp/english/product/computer/>

**Europe**

**URL:** <http://www.yamaha-it.de/>

## 1 The CRW-F1DX drive is not turned on when the power switch is ON. (The power LED does not light.)

### ● Are the AC adapter and the power cable connected properly?

Turn off the power switch and check that the CRW-F1DX drive, the AC adapter, the power cable, and the AC outlet are connected properly. (P. 15, 16)

If not, connect them properly, and then turn on the CRW-F1DX drive.

If the CRW-F1DX is not turned on (the power LED does not light) even if they are connected properly, contact the store of purchase or your nearest Yamaha dealer (listed at the back of this manual).

## For IEEE1394 connection

## 2 The operating system does not start up properly.

### ● Is the IEEE1394 interface card installed properly? (For Windows)

Refer to instruction for the IEEE1394 interface card.

## 3 The CRW-F1DX drive is not recognized by the operating system. (Refer to page 19 for Macintosh or page 33 for Windows to check recognition of the CRW-F1DX drive.)

### ● Is the 1394/USB selector set to IEEE1394?

Set the 1394/USB selector of the CRW-F1DX to IEEE1394.

(P. 15 for Macintosh, P. 29 for Windows)

### ● Is the CRW-F1DX drive connected properly to the computer with the IEEE1394 cable?

Turn off the CRW-F1DX drive and the computer. Check that the IEEE1394 cable is fully connected to the CRW-F1DX drive.

(P. 16 for Macintosh, P. 30 for Windows)

Continued on next page

- **Is the IEEE1394 port recognized properly by the operating system?**

Follow the instruction for the IEEE1394 interface card or the computer, and check that the IEEE1394 port is recognized by the operating system properly. If not, refer to the instruction for the IEEE1394 interface card or the computer. If the IEEE1394 port is still not recognized, there may be a problem with the device driver or elsewhere.

Contact the manufacturer of the IEEE1394 interface card or the computer.

- **Does the CRW-F1DX drive operate properly if the IEEE1394 cable is connected to the other IEEE1394 port of the computer?**

If it does, the specific port of the computer does not operate properly. Contact the manufacturer of the IEEE1394 interface card or the computer.

If the CRW-F1DX drive does not operate properly with any IEEE1394 port, contact the store of purchase or your nearest Yamaha dealer (listed at the back of manual).

### For USB connection

#### 4 The operating system does not start up properly.

- **Is the USB 2.0 interface card installed properly? (For Windows)**

Refer to the instruction for the USB 2.0 interface card.

#### 5 The CRW-F1DX drive is not recognized by the operating system. (Refer to page 26 for Macintosh or page 39 for Windows to check recognition of the CRW-F1DX drive.)

- **Is the 1394/USB selector set to USB?**

Set the 1394/USB selector of the CRW-F1DX to USB.

(P. 22 for Macintosh, P. 35 for Windows)

- **Is the CRW-F1DX drive connected properly to the computer with the USB cable?**

Check that the USB cable is fully connected to the CRW-F1DX drive and the computer. (P. 23 and 25 for Macintosh, P. 36 and 38 for Windows)



---

- **Is the USB port recognized properly by the operating system?**

Follow the instruction for the USB 2.0 interface card or the computer, and check that the USB port is recognized by the operating system properly. If not, refer to the instruction for the USB 2.0 interface card or the computer. If the USB port is still not recognized, there may be a problem with the device driver or elsewhere. Contact the manufacturer of the USB interface card or the computer.

- **Is the included Windows 98 Second Edition USB CD-ROM device driver installed properly? (For Windows 98 Second Edition)**

Windows 98 Second Edition does not recognize the CRW-F1DX drive unless the included Windows 98 Second Edition USB CD-ROM device driver is properly installed. Install the device driver following the instructions of the separate manual “Windows 98 Second Edition USB CD-ROM Device Driver Installation Guide” for the CRW-F1DX drive.

- **Does the CRW-F1DX drive operate properly if the USB cable is connected to the other USB port of the computer?**

If it does, the specific USB port of the computer does not operate properly. Contact the manufacturer of the USB interface card or the computer. If the CRW-F1DX drive does not operate properly with any USB port, contact the store of purchase or your nearest Yamaha dealer (listed at the back of manual).

## 6 The disc tray does not open when you press the eject button.

- **Is the CRW-F1DX drive turned on? (Does the power LED light?)**

Refer to “The CRW-F1DX drive is not turned on when the power switch is ON. (The power LED does not light).” (Troubleshooting, Item 1)

- **Is any CD writing software being used?**

Some CD writing software prohibits ejecting while accessing. (If you are using such a software program, the disc tray does not open even if the eject button is pressed.) In such a case, follow the steps in the software window to eject the disc, or quit the CD writing software prior to pressing the eject button.

- **Is the disc icon shown on the screen? (For Macintosh)**

When the disc icon is shown on the screen, the eject button cannot be used. Drag the disc icon into the **Trash** and drop it there to unmount the disc to open the disc tray.

Continued on next page 

- **Is the disc tray opened when the computer is restarted?**

Quit all running application software, restart your computer, and press the eject button of the CRW-F1DX drive.

For Macintosh, when the disc icon is shown on the screen, the eject button cannot be used. Drag the disc icon into the **Trash** and drop it there to unmount the disc to open the disc tray.

- **Is the disc tray opened when all cables is removed from the CRW-F1DX drive?**

Remove all cables from the drive while the AC adapter is connected. Turn on the drive and press the eject button.

- **Turn off the computer and the CRW-F1DX drive, and remove the disc following "Manually Ejecting a Disc." (P. 44)**

If the disc tray is caught in the drive and does not come out, or if it cannot be opened or closed using the eject button after it is pulled out manually, contact the store of purchase or your nearest Yamaha dealer (listed at the back of this manual).

### 7 The disc is ejected without order (or it comes out spontaneously).

- **Is the disc set properly (horizontally) on the disc tray?**

Set the disc properly, and close the disc tray.

- **Is the disc dusty or dirty?**

Remove dust or dirt from the disc using an air spray or a dry soft cloth. To avoid damaging discs, wipe the disc gently from the center to the edge of the disc.

- **Does the drive accept other discs (audio CD, CD-ROM, blank CD-R disc, etc.)?**

If a specific disc is ejected, the disc itself may be damaged or deformed.

If all discs are ejected, contact the store of purchase or your nearest Yamaha dealer (listed at the back of this manual).

### 8 No data can be read from a disc.

- **Is the disc ejected without order?**

Refer to "The disc is ejected without order (or it comes out spontaneously)." (Troubleshooting, Item 7)

- **Is the disc compatible with the drive? (P. 6, 54)**

Be sure that the disc is compatible with the CRW-F1DX drive.

- **Is the disc dusty or dirty?**

Remove dust or dirt from the disc using an air spray or a dry soft cloth. To avoid damaging discs, wipe the disc gently from the center to the edge of the disc.

---

- **Can data be read from other discs (audio CD, CD-ROM, etc.)?**

If no data can be read from a specific disc, data may be written in a format that the drive cannot recognize, or the disc itself may be damaged or deformed. Note that no data can be read from blank discs, and the CRW-F1DX drive infrequently fail to read data correctly from a disc even if the disc is compatible with the drive.

- **Are the extension files supporting the CRW-F1DX installed?  
(For Mac OS 9.1 and 9.2)**

If the extension files supporting the drive are not installed, the disc cannot be mounted or read. The extension files come with the CD writing software.

- **Does the status LED of the CRW-F1DX drive light correctly when a disc is inserted?**

When a disc is inserted, the status LED will blink blue for a moment and then light blue. (P. 3)

If no data can be read from a specific disc, data may be written in a format that the drive cannot recognize, or the disc may be damaged or deformed.

If the status LED does not light (stating that the drive cannot recognize the disc) no matter what type of disc is inserted, contact the store of purchase or your nearest Yamaha dealer (listed at the back of this manual).

## 9 The playback of an audio CD (CD-DA) is inaudible.

- **Check that the volume is not set to the minimum level.**

- **Be sure that headphones or external speakers are properly connected to the CRW-F1DX drive.**

- **For Windows XP/Me, follow the steps if the playback audio from headphones connected to the CRW-F1DX drive is inaudible.**

If Windows Media Player 7.0 or later is used with Windows XP/Me, this problem can happen since the digital playback option is activated by default setting.

### For Windows XP

1 In the **Device Manager** dialog box (P. 33, 39), select **YAMAHA CRW-F1DX Properties** and then **Properties** tab.

Continued on next page

- 2 Uncheck “Enable digital CD audio for this CD-ROM device” in the “Digital CD Playback” item.

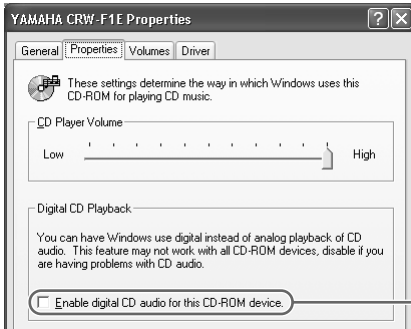

Uncheck  
(This screen is an example on Windows XP.)

- 3 Start “Windows Media Player.” In the menu bar, select **Tools, Options, Devices** tab, **CD-RW Drive**, and **Properties**.
- 4 Select “Analog” in the “Playback” item.

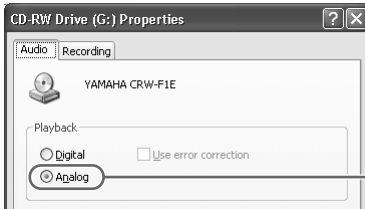

Select  
(This screen is an example on Windows Media Player 8.0.)

**For Windows Me**

- 1 Follow step 1 and 2 on page 49, and uncheck “Enable digital CD audio for this CD-ROM device.”
- 2 Start “Windows Media Player.” In the menu bar, select **Tools, Options** and **CD Audio** tab.
- 3 Uncheck “Digital playback” in the “Playback Settings” item.

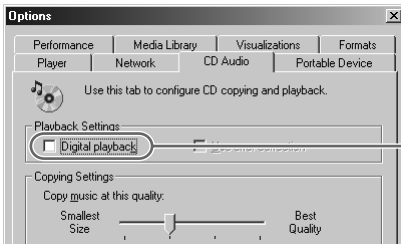

Uncheck  
(This screen is an example on Windows Media Player 7.0.)

---

## 10 No data can be read from any CDs, a disc is ejected spontaneously, or the status LED does not light when a disc is inserted. (The LED does not change to blinking blue and then lighting blue.) (P. 3)

Disconnect all cables from your drive while the AC adapter is connected. Insert the disc once again. If a specific disc is automatically ejected or cannot be read, the disc itself may have a problem. If the drive does not accept any compatible discs (and the status LED does not light), contact the store of purchase or your nearest Yamaha dealer (listed at the back of this manual).

## 11 The error message “Buffer Underrun” is displayed.

If your CD writing software supports Buffer Underrun Protection, it is required to be activated. For details, refer to the instruction for the CD writing software.

To prevent the occurrence of a buffer underrun and to increase the efficiency of data writing, try the following:

- Reduce the data writing speed.
- Create an image file on the hard drive.
- Optimize the hard drive. (Defragmentation)
- Do not start any application software including screen savers during data writing.
- Deactivate the power management for the hard drive.
- Set the data transfer mode of any IDE device such as a hard drive or CD-ROM drive to “DMA.”
- Deactivate Windows Active Desktop.
- Quit all memory-resident software programs.
- Check your CD writing software settings with the instruction for it.

### Note

- If there is an IEEE1394 device with lower data transfer speed connected between the computer and the CRW-F1DX drive, the data transfer between those two will be slowed, which may cause failure in writing a disc.
- When the CRW-F1DX drive is connected to a USB 1.1-compliant port on the computer, the drive operates with USB 1.1 specifications. For secure data writing, activate Buffer Underrun Protection and set the writing speed to 8X for a CD-R disc or 10X for a CD-RW disc with the writing software. (P. 13)
- A writing error may happen if the drive is vibrated while data is being written on a CD-R or a CD-RW disc.

## 12 Other problems

- **Is more than one CD writing software installed on your computer?**

Installing more than one CD writing software on a computer may cause instability of operation.

### For Windows XP

Windows XP includes the CD writing function as a standard feature. Disable the function when the other software that supports the CRW-F1DX drive is used.

- 1 Select **My Computer**, **YAMAHA CRW-F1DX** drive icon (Right-click), and **Properties**.

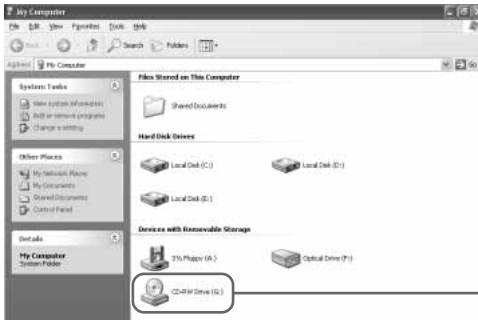

Select YAMAHA  
CRW-F1DX icon

### Note

Generally, “CD-RW Drive” is displayed at the side of the icon. The display may vary depending on the computer environment.

- 2 In the **CD-RW Drive Properties** dialog box, select the **Recording** tab, and uncheck “Enable CD recording on this drive.”

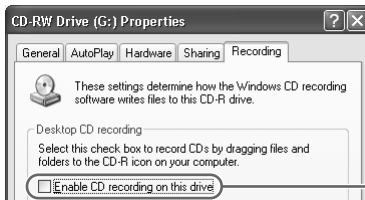

Uncheck

- **CD writing software must support the CRW-F1DX drive in order to recognize the drive.**

Contact the manufacturer of your CD writing software to see whether the software supports the CRW-F1DX drive.

# Firmware

Firmware refers to the operating software designed for your CD-R/RW drive. It is stored in the drive's flash memory so that it can be rewritten.

For the operation reliability, the latest firmware is available on the internet. For information about the latest firmware, refer to the following websites.

YAMAHA CD-R/RW Drive website

URL: <http://www.yamaha.co.jp/english/product/computer/>

Europe

URL: <http://www.yamaha-it.de/>

The latest user support information including firmware information is available on the websites.

Refer to the website regularly to check the latest information.

## Checking the firmware version in the CRW-F1DX drive

### For Macintosh/Windows XP/2000 Professional

Check the firmware version with the CD writing software.

### For Windows 98 Second Edition/Me

In the **Device Manager** dialog box (P. 34, 41), select **YAMAHA CRW-F1E** to display the **YAMAHA CRW-F1E Properties** dialog box, and then select the **Settings** tab.

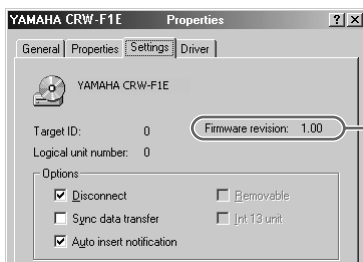

The revision number varies depending on the default firmware version. (This screen is an example on Windows Me.)

# CRW-F1DX Drive Specifications

## Supported Formats

	Write	Read	Play back <sup>*4</sup>
CD-DA	●	●	●
CD TEXT	●	●	●
CD-ROM <sup>*1</sup>	●	●	●
Mixed Mode CD-ROM (CD-ROM+CD-DA)	●	●	●
CD-ROM XA <sup>*1</sup>	●	●	●
Photo CD <sup>*1</sup>	● <sup>*2 *3</sup>	●	●
Video CD	●	●	●
CD-i	●	● <sup>*3</sup>	—
CD EXTRA <sup>*1</sup>	●	●	●
CD-MRW	●	●	●

<sup>\*1</sup> includes multisession

<sup>\*2</sup> proper disc required

<sup>\*3</sup> proper application software required

<sup>\*4</sup> proper application software may be required depending on the format

## Writing Methods

Disc-at-Once (DAO)  
 Session-at-Once (SAO)  
 Track-at-Once (TAO)  
 Packet Writing  
 Audio Master Quality Recording  
 (High quality audio writing mode)  
 CD-MRW (CD Mount Rainier ReWriting)

## Writing/Reading Speed

Writing	CD-R	1X, 4X, 8X, 16X CLV 44X (max.) Full CAV
	CD-RW	2X, 4X, 10X, 12X, 16X CLV 24X Partial CAV 10X, 24X Full CAV (Packet writing)
Reading	DATA	44X (max.) Full CAV
	CD-DA	44X (max.) Full CAV (Audio data extraction) 1X CLV (Audio playback)
	Video CD	10X (max.) Full CAV
	Note)	Session unclosed disc: 12X (max.) CLV

## Data Capacity

700MB (79 minutes)  
 650MB (74 minutes)

## Maximum Recording Time in Audio Master Quality Recording

68 minutes (with a 700MB disc)  
 63 minutes (with a 650MB disc)



<b>Data Transfer Rate (Mode 1)</b>	150KB/s (1X) to 6,600KB/s (44X)
<b>Interface</b>	IEEE1394-a: Two 6-pin connectors (power not supplied to port) USB 2.0/1.1
<b>Burst Transfer Rate</b>	IEEE1394-a compliant: 400 Mbps (max.) USB 2.0 (HIGH SPEED MODE): 480 Mbps (max.) USB 1.1 (FULL SPEED MODE): 12 Mbps (max.)
<b>Data Buffer Size</b>	8MB (3,176 sectors)
<b>Average Access Time</b>	130 ms (random access)
<b>Sector Size</b>	2,048 to 2,448 bytes
<b>Installing Style</b>	Horizontal
<b>Disc Loading Type</b>	Front automatic tray loading
<b>Audio Out</b>	Line Out specifications <ul style="list-style-type: none"> <li>• Frequency range: 20 to 20,000 Hz</li> <li>• Output level: 700 mVrms</li> </ul>
<b>Power Consumption</b>	22 W (writing/playback) 9 W (standby)
<b>Operating Environment</b>	Temperature: 5 to 35 °C Humidity: 25 to 80% RH (no condensation)
<b>Dimensions (includes projection)</b>	Width: 181.0 mm Height: 57.3 mm Depth: 275.0 mm
<b>Weight</b>	1.7 kg

## CRW-F1DX Drive Specifications

---

### AC adapter (LSE0107A1236)

<b>Rated Input Voltage</b>	AC 100 to 240 V
<b>Rated Input Current</b>	1.0 A or less
<b>Rated Output Voltage</b>	DC 5 V, 12 V
<b>Rated Output Current</b>	3.0 A
<b>Terminal Output Polarity</b>	 DC 12 V
<b>Operating Environment</b>	Temperature: 5 to 35 °C Humidity: 25 to 80% RH (no condensation)
<b>Dimensions (includes projection)</b>	Width: 51.0 mm Height: 31.0 mm Depth: 115.0 mm
<b>Weight (excludes the power cable)</b>	250 g (approx.)

## Safety/EMC Compliance

The CRW-F1DX drive conforms to the following specifications.

Country/ Region	Compliance Specifications			Remarks
	Category	Item	Standard	
<b>USA</b>	Safety	Electricity	UL60950	Information Technology Equipment
		Laser	21CFR1040.10 FDA Chapter 1, Subchapter J	Class I Laser Product
	EMC	Emission	47CFR15 FCC Part 15, Subpart B	Peripheral Device
<b>Canada</b>	Safety	Electricity	CSA C22.2 No. 60950	Information Technology Equipment
	EMC	Emission	ICES-003	Class B Digital Device
<b>EU</b>	Safety	Electricity	EN60950	Information Technology Equipment
		Laser	EN60825	Class 1 Laser Product
	EMC	Emission	EN55022	Class B Information Technology Equipment
		Immunity	EN55024 EN61000-3-2 EN61000-3-3	
<b>Australia New Zealand</b>	EMC	Emission	AS/NZ 3548	Class B Information Technology Equipment
<b>Japan</b>	Safety	Electricity	Electrical Appliance and Material Safety	
	EMC	Emission	VCCI	Class B Information Technology Equipment

Note that the specifications of the CRW-F1DX drive are subject to change without notice due to improvements.

# Technical Notes

## Buffer Underrun Protection Function

CD-R/RW drives are equipped with a buffer memory, which temporarily stores data that is being transferred. When the buffer memory becomes empty due to a delay of data transfer for any reason, a writing error happens. Such condition is defined as buffer underrun, and such an error is defined as a buffer underrun error.

### **Buffer Underrun Protection is featured in the CRW-F1DX drive.**

When buffer underrun almost happens, Buffer Underrun Protection temporarily suspends the writing process. Writing resumes when enough data has accumulated in the buffer memory. Buffer Underrun Protection in the CRW-F1DX drive is extremely accurate, resulting in seamless recording before and after suspension.

### Test writing

Test writing is a function to check for the possible occurrence of buffer underrun in your computer environment. When Buffer Underrun Protection of the CD writing software is activated, the test writing function cannot be operated. Buffer Underrun Protection should be deactivated to operate the test writing function.

## Writing Methods

### **Disc-at-Once (DAO)**

This method is used to write all data onto a disc in one operation. It writes multiple pieces of data without placing a space between data, starting with the innermost track of the disc. Once data is written by this method, no data can be added to the same disc even if there is free space available on the disc. This method is useful for making a backup copy of an entire disc.

### **Track-at-Once (TAO)**

This method is used to write data on a disc on a track-by-track basis. A track can be defined as the smallest unit of area that contains an ordinary program, image file, text file, etc. This method enables you to add data to the same disc, one track of data at a time, as long as there is free space available on the disc. A disc that contains data written in several sessions is defined as a multi-session disc.

An area that records data and management information (Lead-in/Lead-out) is defined as a session. Lead-in and Lead-out are signals written for stating the starting and ending points of one session.

### **Note**

Ordinary audio CD players can only play back single-session discs or the first session on a multi-session disc. Do not record audio data on the second and subsequent sessions.

---

## Session-at-Once (SAO)

This method is used to write data on a disc on a session-by-session basis. Unlike Track-at-Once described above, Session-at-Once enables you to record multiple tracks onto a disc at a time. CD EXTRA, for example, uses this method to write multiple pieces of audio data (or multiple tracks) in the first session and information required for computers in the second session. This method enables you to add data into the same disc, one session at a time, as long as there is free space available on the disc. A disc that contains data written in several sessions by this method is defined as a multi-session disc, like a disc written by the Track-at-Once method.

## Packet Writing

This method is used to record data onto a disc on a file-by-file basis. This method divides a track into small segments called “packets” so that data can be written on a packet-by-packet basis, which means that you can write data in much the same way as you copy data to a floppy or hard drive. Since the data can be written easily, packet writing is proper to daily data backup. Packet writing also enables you to add packets to a disc as long as there is free space available on the disc.

### Note

- Discs need to be formatted for packet writing prior to use.
- Formatting a CD-RW disc using packet writing software reduces its storage capacity by about 100MB since packet writing requires exclusive space for itself.
- For CD-R discs, deleting data means masking data but not actually removing data. Therefore, actual free space in a CD-R never be increased even if data is deleted.

## Audio Master Quality Recording (High quality audio writing mode)

This method enables you to record high quality data that can be played back with the 1.4 m/s linear velocity.

### Note

- Audio Master Quality Recording is enabled with the 1X-, 4X-, or 8X-speed Disc-at-Once writing method.
- Maximum recording time is 63 minutes for a 650MB CD-R disc and 68 minutes for a 700MB CD-R disc.
- Audio CDs that are created with Audio Master Quality Recording may not be played back on certain audio recorders and CD-R/RW drives.

### CD-MRW (CD Mount Rainier ReWriting)

This method is a new standard of packet writing for a CD-RW disc and supports defect control by the drive, background formatting, and disc ejecting during formatting. It enables you to use a CD-RW disc like a floppy disk.

#### Note

Formatting a CD-RW disc using CD-MRW reduces its storage capacity by about 150MB since CD-MRW requires exclusive disc space.

### Constant Linear Velocity (CLV)

The disc rotation speed is adjusted to the data transfer rate while writing/reading data.

### Constant Angular Velocity (CAV)

The data transfer rate is adjusted to keep the disc rotation speed while writing/reading data. The Full CAV method employs CAV all through data writing/reading.

### Partial CAV

The CAV method is employed for inner tracks of a disc and the CLV method for outer tracks while writing/reading data.

## IEEE1394

IEEE1394 is a global standard approved by Institute of Electrical and Electronics Engineers (IEEE). The serial interface has a broad bandwidth and is fast enough to transfer large amounts of digital video and audio data bi-directionally between electronic devices including computer peripherals. Defined as FireWire or i.LINK, the IEEE1394 interface enables units to transfer data or various controls over a single IEEE1394 cable. IEEE1394 enables a daisy-chain of devices (serial connection) to transfer data between any two devices in the chain. IEEE1394 also supports a tree (parallel) connection of devices. In addition to this flexibility, IEEE1394 also eliminates the need for complicated settings such as device ID and termination as found with SCSI (Small Computer System Interface) type interfaces. As of this writing, IEEE1394 supports three different data transfer rates: 100 Mbps, 200 Mbps, and 400 Mbps.

## Connecting Multiple IEEE1394 Devices

The following describes how to connect multiple IEEE1394 devices including the CRW-F1DX drive to the computer.

### Connecting in a daisy-chain

This method is used to connect in series multiple IEEE1394 devices to one IEEE1394 port. Up to 17 IEEE1394 devices (including the host adapter) can be connected through one channel.

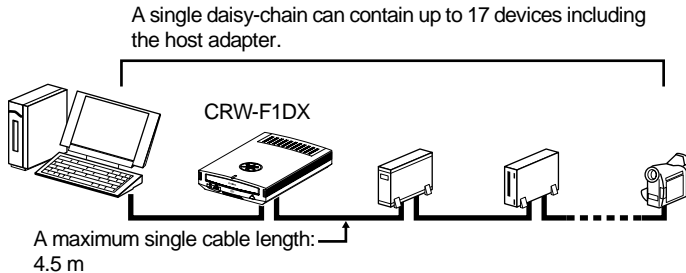

### Connecting in a tree

This method is used to connect in branches multiple IEEE1394 devices through the device, host adapter for example, with more than two IEEE1394 ports. Up to 63 IEEE1394 devices (including the host adapter) can be connected.

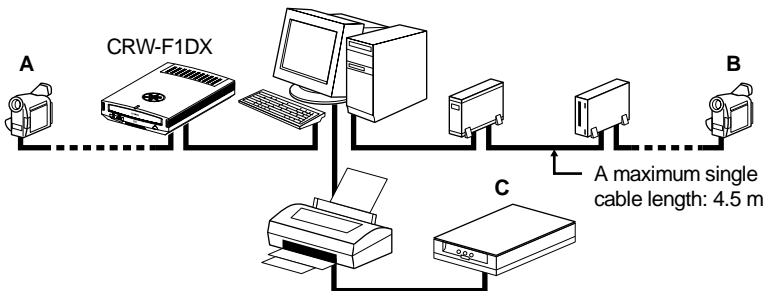

- Each path (A-B, A-C, B-C) can contain up to 17 devices including the host adapter.
- An entire system can contain up to 63 devices including the host adapter.

### Note on Connecting IEEE1394 Devices

- Connect the CRW-F1DX drive directly to the computer.
- If there is an IEEE1394 device with lower data transfer speed connected between the computer and the CRW-F1DX drive, the data transfer between those two will be slowed, which may cause failure in writing a disc.
- The IEEE1394 ports on the CRW-F1DX drive have 6-pin connectors, but do not supply power (IEEE1394 bus power).
- Be sure not to connect the devices with closed-loop as follows.

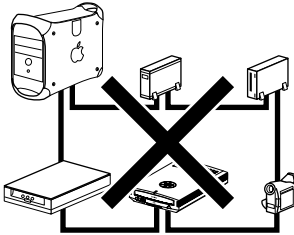



## **Distributors and Head Offices / Vertriebs- und Hauptgeschäftsstelle Distributeurs et sièges sociaux / Distribuidores y Casas matrices**

If you have any questions, please contact the store of purchase or your nearest Yamaha dealer listed below. Contact Yamaha Corporation Japan from outside of the listed countries.

Falls Sie weitere Fragen haben, wenden Sie sich an Ihren Fachhändler oder den örtlichen Yamaha-Händler (eine Liste der Yamaha-Händler befindet sich am Ende dieses Handbuchs). Aus anderen Ländern als den aufgeführten wenden Sie sich an Yamaha Corporation Japan.

Si vous avez des questions à poser, veuillez prendre contact avec le magasin où vous avez fait l'achat de l'appareil ou un revendeur de matériel Yamaha le plus proche de votre domicile parmi ceux énumérés ci-dessous. Prenez contact avec Yamaha Corporation Japan si vous ne vous trouvez pas dans un des pays mentionnés:

Si tiene alguna duda, póngase en contacto con el establecimiento de adquisición o con su representante Yamaha más cercano indicado a continuación. En caso de países no contemplados en la lista, póngase en contacto con Yamaha Corporation Japan:

### **EUROPE, EASTERN EUROPE and RUSSIA**

**Yamaha Elektronik Europa GmbH  
IT-Sales Division**

Siemensstrasse 22-34,  
D-25462 Rellingen, GERMANY

**URL: <http://www.yamaha-it.de/>**

TEL: +80092624222

(AUSTRIA, BELGIUM, DENMARK, FINLAND,  
FRANCE, GERMANY, HUNGARY, ICELAND,  
IRELAND, ITALY, LUXEMBOURG,  
NETHERLANDS, NORWAY, PORTUGAL, SPAIN,  
SWEDEN, SWITZERLAND, UNITED KINGDOM)

TEL: +80093067  
(MONACO)

If you are calling from outside the countries mentioned above, or if you can't get through on the Yamaha toll-free number, use the following number instead:

TEL: +3214400793

### **U.S.A.**

**Yamaha Electronics Corporation, USA**

6660 Orangethorpe Avenue,  
Buena Park, CA 90620, U.S.A.

TEL: +1 714 522 9105

FAX: +1 714 670 0108

**URL: <http://www.yamaha.com/>**

### **CANADA**

**Yamaha Canada Music Ltd.**

135 Milner Avenue, Scarborough,  
Ontario M1S 3R1, CANADA

TEL: +1 416 298 5664

FAX: +1 416 292 0732

**URL: <http://www.yamaha.ca/>**

### **AUSTRALIA**

**Yamaha Music Australia Pty., Ltd.**

Level 1, 99 Queensbridge Street  
Southbank, Victoria 3006

AUSTRALIA

TEL: +61 3 9693 5111

FAX: +61 3 9699 2332

### **SINGAPORE, MALAYSIA, KOREA, THAILAND, PHILIPPINES, INDIA, VIETNAM, CAMBODIA, MYANMAR, INDONESIA and IRAN**

**Yamaha Electronics Asia Pte Ltd.**

138 Cecil Street

#05-02/03 Cecil Court, Singapore 069538 SINGAPORE

TEL: +65 223 3992

FAX: +65 223 9810

### **TAIWAN**

**Yamaha KHS Music Co., Ltd.**

11F, No.150, Tun Hua North Rd.

Taipei, TAIWAN R.O.C.

TEL: +886 2 2713 8999

FAX: +886 2 2713 8666

**URL: <http://www.yamahakhs.com/>**

### **JAPAN**

**Yamaha Corporation**

**AV & IT Business Group**

**Overseas Sales & Marketing Division**

10-1 Nakazawa-cho, Hamamatsu-shi, Shizuoka-ken  
430-8650, JAPAN

TEL: +81 53 460 3411

FAX: +81 53 467 2110

**URL: <http://www.yamaha.co.jp/english/>**



**YAMAHA**

CREATING 'KANDO' TOGETHER

'KANDO' --- Inspiring the Heart and Spirit.

YAMAHA CORPORATION

X3346A0 CRW-F1DX(W)

Printed in Malaysia

Printed on 70% recycled paper